



MEDITERRANEA la piscina indipendente / *Mediterranea the independent swimming pool*

1

STRUTTURA PISCINA

STRUCTURE

	CASSAFORMA ISOBLOK / ISOBLOK FORMWORK
24	CARATTERISTICHE TECNICHE / TECHNICAL FEATURES
28	ISOBLOK SERIE KS
32	KIT PISCINE ACQUAFORM/ACQUAFORM SWIMMING POOLS KIT
	EPS BLOK/EPS BLOK
	PANNELLI TWENTY/TWENTY PANELS
35	PANNELLI D'ACCIAIO BI PLASTIFICATI/ BI PLASTIFIED STEEL PANELS
37	KIT PISCINE PANNELLI TWENTY / TWENTY POOL PANELS KIT
	MINI PISCINE/MINI SWIMMING POOL
40	GARDEN
41	LIBERTY
	PISCINA INDIPENDENTE/ INDEPENDENT MEDITERRANEA POOL
43	MEDITERRANEA
	BORDI SFIORO / OVERFLOW EDGES
45	BORDI STANDARD, FINLANDESE E SPIAGGIA
46	GRIGLIE / GRIDS
48	PLACCHE AD ANGOLO / CORNER PLATES
49	VASCHE DI COMPENSO / OVERFLOW TANKS
	SCALE / STAIRS
52	SCALE IN ACRILICO / ACRYLIC STAIRS
54	RICAMBI PER SCALE / STAIRS SPARE PARTS
55	SCALE SOTTO LINER / UNDER LINER STAIRS
56	SCALE CON PANCA CON KIT IDROMASSAGGIO / STAIRS WITH SITTING COMPLETE WITH HYDROMASSAGE JETS KIT
59	VERNICI E SILICONI IMPERMEABILI / WATERPROOF PAINTS AND SILICONS
	RIVESTIMENTI / COATINGS
62	AQUALINER 75/100 E LINER IN PVC TINTA UNITA O STAMPATI/PVC LINER IN SOLID COLOURS OR PRINTED
64	GAMMA DELIFOL
65	GAMMA RENOLIT
66	GAMMA ALKORPLAN
72	PRODOTTI PER ALKORPLAN / PRODUCTS FOR ALKORPLAN
73	GAMMA ELBTAL
78	FASCE SILDABILI E LINERLOCK / WELDABLE BANDS AND LINERLOCK
79	GUIDE, TASSELLI E PROFILI / GUIDES, ANCHORS AND PROFILES
80	MATERASSINI E COMPLEMENTI LINER
82	LEISTER
	PIASTRELLE E BORDI / TILES AND EDGES
84	BORDO PISCINA ROSALIND ANTISCIVOLO / ROSALIND POOL EDGE ANTI-SLIP
85	BORDO PISCINA LISCIO / SMOOTH POOL EDGE
85	TRATTAMENTO ANTISCIVOLO / ANTI-SLIP TREATMENT
86	BORDO ESPACE / ESPACE EDGE
88	BORDO CASTELLANE / CASTELLANE EDGE
	PROTEZIONE E CURA / PROTECTION AND CARE
89	PRODOTTI DI PROTEZIONE E CURA/ PROTECTION AND CARE PRODUCTS

CASSAFORMA ISOBLOK ISOBLOK FORMWORK

Sistema di costruzione per piscine in cemento armato con pareti a doppio isolamento.
Construction system for reinforced concrete pools with double-wall insulation.

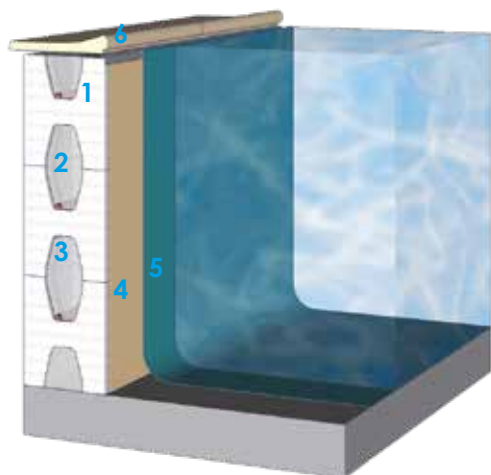

COMPOSIZIONE COMPOSITION

- 1 ISOBLOK / ISOBLOK
- 2 FERRO DI ARMATURA / REINFORCED IRON
- 3 CALCESTRUZZO / CONCRETE
- 4 MATERASSINO DI PROTEZIONE / PROTECTIVE UNDERLAY
- 5 LINER IN PVC / PVC LINER
- 6 GUIDA IN ALLUMINIO DI AGGANCIO RIVESTIMENTO
ALUMINUM GUIDE TO ATTACH THE LINER



CARATTERISTICHE TECNICHE

TECHNICAL FEATURES

C.P.A. srl è produttore diretto del sistema ISOBLOK, sistema di cassetta isoterma pre-formata, facile e veloce per il getto di piscine in calcestruzzo.

Grazie alla sua leggerezza e alle sue caratteristiche di compattezza, il prodotto viene spedito con un imballo di sicurezza per il trasporto. ISOBLOK si monta con facilità e senza fatica, garantendo un cantiere pulito, senza l'uso di pesanti attrezzature.

La sua proprietà isoterma permette alla piscina di mantenere più a lungo la temperatura raggiunta dall'acqua nei mesi estivi e riduce con il supporto di un'ideale copertura isoterma il consumo energetico degli impianti per il riscaldamento.

C.P.A. Ltd is the direct manufacturer of ISOBLOK system, pre-formed isothermal formwork system, easy and quick to build concrete pools. Thanks to its lightness and compactness, the product is sent with a safety packaging for transport. ISOBLOK is easily assembled without any effort, ensuring a clean site, without the usage of heavy equipment. Its isothermal property allows the swimming pool to maintain the temperature reached by the water during summertime for longer and reduces the energy consumption of heating equipment, with the support of an appropriate isothermal coverage.

ISOBLOK viene prodotto da C.P.A. La linea di produzione comprende 3 tipologie di casseri in 3 dimensioni diverse. 7 linee di stampo.

ISOBLOK is produced by C.P.A. The production line includes 3 types of formwork in 3 different sizes. 7 mold lines.

ISOBLOK 1250

per le forme rettangolari, mm 1250x275x250 / for rectangular shapes 1250x275x250 mm

ISOBLOK 2000

per le forme libere, con le misure di mm 1250x275x250 / for free-shape, with the measures 1250x275x250 mm

ISOBLOK 300KS

per le forme rettangolari, mm 1250x300x250 / for rectangular shapes, 1250x300x250 mm

ISOBLOK 301KS

per le forme libere, con le misure di mm 1250x300x250 / for free-shape, with the measures 1250x300x250 mm

COMPOSIZIONE COMPOSITION

Isoblok è:

- traspirante ma impermeabile all'acqua
- atossico, inerte
- compatibile con cemento, calcestruzzo, muratura, malte cementizie, membrane impermeabili / bituminose, malte impermeabili per posa mosaico / piastrelle
- adatto alle più svariate applicazioni
- semplice da trasportare, immagazzinare, installare
- autoestinguento
- riciclabile al 100%
- adattabile a qualsiasi supporto
- indeformabile

Isoblok possiede:

- straordinarie caratteristiche tecniche
- eccellenti proprietà di isolante termico
- resistenza all'acqua
- basso rischio di tossicità in caso di incendio
- omologazione in classe I
- capacità di conservazione nel tempo

Inoltre Isoblok:

- non scioglie in acqua
- non è degradabile nel tempo
- non sostiene la crescita di funghi, muffe, batteri
- non contiene clorofluorocarburi ne idroclorofluoro carburi
- non rilascia gas tossici
- non costituisce un pericolo per la salute
- non inquina l'ambiente
- non crea disordine e sporcizia

Isoblok is:

- *breathable but waterproof*
- *non-toxic, inert*
- *compatible with cement, concrete, masonry, cement mortars, waterproof membranes / bituminous, waterproof mortars for mosaic/tiles laying*
- *suitable to various applications*
- *easy to transport, store, install*
- *self-extinguishing*
- *100% recyclable*
- *adaptable to any support*
- *non-deformable*

Isoblok has got:

- *excellent technical characteristics*
- *excellent thermal insulation properties*
- *resistance to water*
- *low risk of toxicity in case of fire*
- *Class I approval*
- *preservation capacity over time*

Moreover Isoblok:

- *does not dissolve in water*
- *is not degradable over time*
- *does not support the growth of fungi, molds, bacteria*
- *does not contain chlorofluorocarbons nor hydrochlorofluorocarbons*
- *does not release toxic gases*
- *does not constitute a danger to health*
- *does not pollute the environment*
- *does not create disorder and dirt*

PRINCIPALI FASI DI INSTALLAZIONE / MAIN STEPS OF INSTALLATION



FASE 1

La piscina viene tracciata sul terreno e si realizza lo scavo secondo le dimensioni desiderate. Quindi si provvede al getto del basamento.



FASE 2

Si procede alla posa dei casseri con l'inserimento dei ferri d'armatura, dopodichè si inseriscono tutti gli accessori da murare.



FASE 3

Si procede al getto del calcestruzzo mediante pompa, questa operazione si effettua riempiendo agilmente i casseri ISOBLOK con il calcestruzzo.



FASE 4

Si procede alla posa delle guide e della membrana PVC, con l'installazione delle flange di tenuta e degli accessori. Infine si completa l'installazione andando a riempire la vasca con acqua potabile.



FASE 5

Date sfogo alla vostra fantasia arredando con gusto l'ambiente che circonda la piscina (pavimentazione in pietra ricostruita, in legno, ecc...).

1. The pool is layed out on the ground and the excavation is done according to the desired size. Then we do the jet of the basement.
2. We proceed with the installation of the formwork with the fitting of reinforcing irons, then we fit all the accessories to be built.
3. We proceed with the casting of concrete with a pump in the ISOBLOK formwork.
4. We proceeds to the laying of the guides and the PVC membrane, with the installation of the flanges and accessories. Finally, we complete the installation filling the pool with clean water.
5. Unleash your imagination decorating the place surrounding the pool (stone, wood paving and so on).

ESEMPI DI FORME REALIZZABILI CON ISOBLOK
EXAMPLES OF SHAPES ACHIEVABLE WITH ISOBLOK



CLASSICA



RUBINO



PORTOFINO



RELAX

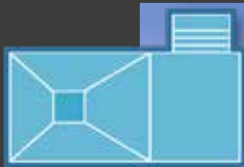

BEACHTIME



TAORMINA

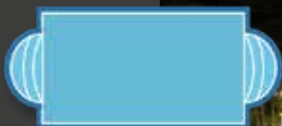

SORRENTO

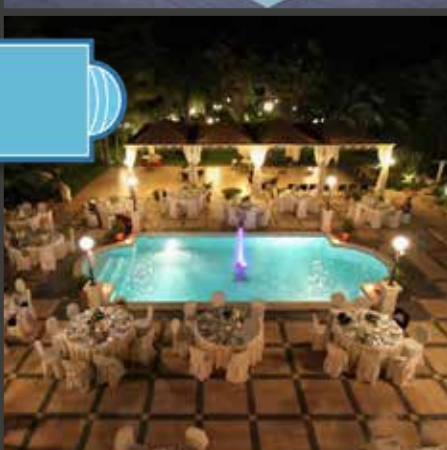

FIRENZE





AMALFI



CARAIBI



ELBA



ISCHIA

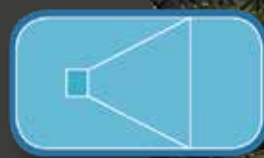

MONTECARLO

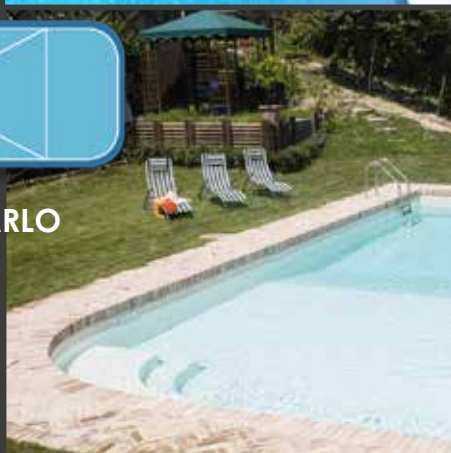

SEABEACH



TROPEA



FORMA LIBERA



ISOBLOK SERIE KS

Nuovo cassero Isoblok Serie 300KS - 301KS mantiene le stesse caratteristiche dell'ISOBLOK Serie 1250, ma con i seguenti vantaggi:

- altezza del cassero 30 cm
- maggiore elasticità per pareti curve
- stampa in polistirene alta densità per pareti diritte e a forma libera
- getto di calcestruzzo dosaggio fine, densità C25/30

New formwork Isoblok Series 300KS - 301KS has the same characteristics of ISOBLOK Series 1250, but with the following advantages:

- height of the Isoblok 30 cm
- flexibility for curved walls
- high density polystyrene mould for straight and free-form walls
- concrete jet fine dosage, density C25/30

Codice/code	Descrizione/description	Dimensioni/dimensions
1063000	ISOBLOK 300KS – parete diritta / rectangular form	dim. 1250x300x250
1063001	ISOBLOK 301KS – parete forma libera / free form	dim. 1250x300x250

Codice/code	Descrizione/description
1063002	Chiavetta di tamponamento angoli / buffering angles key
1063003	Chiavetta di curvatura casseri Rif.A / bending key rif. A
1063004	Chiavetta di curvatura casseri Rif.B / bending key rif. B
1063005	Chiavetta di curvatura casseri Rif.C / bending key rif. C
1063006	Chiavetta di curvatura casseri Rif.D / bending key rif. D
1063007	Chiavetta di curvatura casseri Rif.E / bending key rif. E
1063008	Chiavetta di curvatura casseri Rif.F / bending key rif. F
1063009	Chiavetta di curvatura casseri Rif.G / bending key rif. G
1063010	Chiavetta di curvatura casseri Rif.H / bending key rif. H



**TAGLIOBLOK PER IL TAGLIO E LA LAVORAZIONE ISOBLOK
TAGLIOBLOK FOR ISOBLOK CUTTING AND PROCESSING**

Codice/code	Descrizione/description
1050640	Taglioblok
1050641	Filo di ricambio / Spare wire



KIT PISCINE ACQUAFORM ACQUAFORM SWIMMING POOLS KIT



Mod.
CLASSICA



COMPONENTI DEL KIT / KIT COMPONENTS

Dim in m			Sup m ²	Volume m ³				Profondità				Locale tecnico	Asp.	Mand.	SK	BC	PS	PF	Filtro	Pompa hp	Portata m ³ /h
A	B	C		FP	FT	FP	FT	FP	FT	FP	FT										
7	3	-	21	25	28	31,5	34	1,20	1,80	1,50	2,00	Big Mac	n°2 Ø50	n°1 Ø50	1	2	-	1	Medit.500	0,75	10
8	4	-	32	38	43	48	52	1,20	1,80	1,50	2,00	Big Mac	n°2 Ø50	n°1 Ø50	1	2	-	1	Medit.500	0,75	10
9	3	-	27	32	36	40,5	44	1,20	1,80	1,50	2,00	Big Mac	n°2 Ø50	n°1 Ø50	1	2	-	1	Medit.500	0,75	10
9	4	-	36	43	48	54	58	1,20	1,80	1,50	2,00	Big Mac	n°2 Ø50	n°1 Ø50	1	2	-	1	Medit.500	0,75	10
10	4	-	40	48	56	60	65	1,20	1,80	1,50	2,00	Sedici	n°4 Ø50	n°3 Ø50	2	3	1	1	Medit.650	1	16
10	5	-	50	60	71	75	83	1,20	1,80	1,50	2,00	Sedici	n°4 Ø50	n°3 Ø50	2	3	1	1	Medit.650	1	16
11	5	-	55	66	78	82,5	91	1,20	1,80	1,50	2,00	Sedici	n°4 Ø50	n°3 Ø50	2	3	1	1	Medit.650	1	16
12	5	-	60	72	85	90	99	1,20	1,80	1,50	2,00	Sedici	n°4 Ø50	n°3 Ø50	2	3	1	1	Medit.650	1	16
12	6	-	72	86	102	108	119	1,20	1,80	1,50	2,00	Comodo	n°4 Ø50-n°1 Ø63	n°3 Ø50	3	4	1	1	Medit.750	2	23
13	6	-	78	94	110	117	129	1,20	1,80	1,50	2,00	Comodo	n°4 Ø50-n°1 Ø63	n°3 Ø50	3	4	1	1	Medit.750	2	23
14	5	-	70	84	99	105	116	1,20	1,80	1,50	2,00	Comodo	n°4 Ø50-n°1 Ø63	n°3 Ø50	3	4	1	1	Medit.750	2	23
14	6	-	84	101	119	126	139	1,20	1,80	1,50	2,00	Comodo	n°4 Ø50-n°1 Ø63	n°3 Ø50	3	4	1	1	Medit.750	2	23
14	7	-	98	118	138	147	162	1,20	1,80	1,50	2,00	Comodo alto	n°4 Ø50-n°1 Ø63	n°3 Ø50	3	5	1	1	Medit.900	3	30
15	7	-	105	126	147	157,5	172	1,20	1,80	1,50	2,00	Comodo alto	n°4 Ø50-n°1 Ø63	n°3 Ø50	3	5	1	1	Medit.900	3	30
16	7	-	112	134	158	168	185	1,20	1,80	1,50	2,00	Comodo alto	n°4 Ø50-n°1 Ø63	n°3 Ø50	4	5	1	1	Medit.900	3	30
16	8	-	128	154	181	192	211	1,20	1,80	1,50	2,00	Globo	n°5 Ø50	n°4 Ø50	4	6	1	1	n°2 Medit.750	1,5	42
18	9	-	162	194	228	243	267	1,20	1,80	1,50	2,00	Globo	n°5 Ø50	n°4 Ø50	6	8	1	1	n°2 Medit.750	1,5	42
20	10	-	200	240	282	300	329	1,20	1,80	1,50	2,00	Master	n°4 Ø50	n°5 Ø50	8	10	1	1	n°2 Medit.750	3	54

Legenda voci tabella

Riv = rivestimento

Asp = aspirazioni

BC = bocchette

L = liner

Mand= mandate

PS = presa spazzola

M =membrana

SK= skimmer

PF = pozzetto di fondo



PREZZI KIT / KIT PRICES

A	Dim in m		Kit piscina 1,20 fondo piano	Kit piscina 1,20 fossa tuffi	Kit piscina 1,50 fondo piano	Bordo Bianco	Bordo Rosalind	Copertura isoter- mica estiva blu	Copertura invernale + tubolari
	B	C	cod	cod	cod	cod	cod	cod	cod
7	3	-	2120025	2122015	2150020	1021118	1021518	1061019	1063019
8	4	-	2120026	2122016	2150021	1021119	1021519	1061020	1063020
9	3	-	2120027	2122017	2150022	1021120	1021520	1061021	1063021
9	4	-	2120028	2122018	2150023	1021121	1021521	1061022	1063022
10	4	-	2120029	2122019	2150024	1021122	1021522	1061023	1063023
10	5	-	2120030	2122020	2150025	1021123	1021523	1061024	1063024
11	5	-	2120031	2122021	2150026	1021124	1021524	1061025	1063025
12	5	-	2120032	2122022	2150027	1021125	1021525	1061026	1063026
12	6	-	2120033	2122023	2150028	1021126	1021526	1061027	1063027
13	6	-	2120034	2122024	2150029	1021127	1021527	1061028	1063028
14	5	-	2120035	2122025	2150030	1021128	1021528	1061029	1063029
14	6	-	2120036	2122026	2150031	1021129	1021529	1061030	1063030
14	7	-	2120037	2122027	2150032	1021130	1021530	1061031	1063031
15	7	-	2120038	2122028	2150033	1021131	1021531	1061032	1063032
16	7	-	2120039	2122029	2150034	1021132	1021532	1061033	1063033
16	8	-	2120040	2122030	2150035	1021133	1021533	1061034	1063034
18	9	-	2120041	2122031	2150036	1021134	1021534	1061035	1063035
20	10	-	2120042	2122032	2150037	1021135	1021535	1061036	1063036



Classica

**KIT PISCINE ACQUAFORM
ACQUAFORM SWIMMING POOLS KIT**



**Mod.
RELAX**

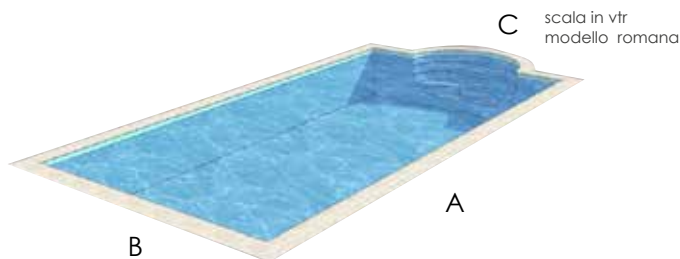

COMPONENTI DEL KIT / KIT COMPONENTS

Dimensioni [m]			Sup [m ²]	Volume [m ³]				Profondità [m]				Locale tecnico	Aspirazioni	Mand.	SK	BC	PS	PF	Filtro modello	Pompa [hp]	Portata [m ³ /h]
A	B	C		FP 1,20	FT 1,20	FP 1,50	FT 1,50	FP 1,20	FT 1,20	FP 1,50	FT 1,50										
8,75	3,5	2,5	29	35	39	43	46	1,20	1,80	1,50	2,00	Big Mac	n°2 Ø50	n°1 Ø50	1	2	-	1	medit. 500	0,75	10
9,75	4	2,5	37	44	49	55	59	1,20	1,80	1,50	2,00	Big Mac	n°2 Ø50	n°1 Ø50	1	2	-	1	medit. 500	0,75	10
10,5	4	2,5	40	48	53	60	64	1,20	1,80	1,50	2,00	Big Mac	n°2 Ø50	n°1 Ø50	1	2	-	1	medit. 500	0,75	10
11	4,5	3	47	56	64	70	77	1,20	1,80	1,50	2,00	Sedici	n°4 Ø50	n°3 Ø50	2	3	1	1	medit. 650	1	16
12	5,5	3	62	74	83	93	100	1,20	1,80	1,50	2,00	Sedici	n°4 Ø50	n°3 Ø50	2	3	1	1	medit. 650	1	16
13,5	6	3	76	92	102	114	124	1,20	1,80	1,50	2,00	Comodo	n°4Ø50-n°1Ø63	n°3 Ø50	3	4	1	1	medit. 750	2	23
14,5	6	3	82	99	112	123	134	1,20	1,80	1,50	2,00	Comodo	n°4Ø50-n°1Ø63	n°3 Ø50	3	4	1	1	medit. 750	2	23
16	6	3	91	110	123	137	148	1,20	1,80	1,50	2,00	Comodo alto	n°4Ø50-n°1Ø63	n°3 Ø50	3	5	1	1	medit. 900	3	30

PREZZI KIT / KIT PRICES

A	Dim in m		Kit piscina 1,20 fondo piano	Kit piscina 1,20 fossa tuffi	Kit piscina 1,50 fondo piano	Bordo Bianco	Bordo Rosalind	Copertura isoter- mica estiva blu	Copertura invernale + tubolari
	B	C	cod	cod	cod	cod	cod	cod	cod
8,75	3,5	2,5	2120077	2122067	2150072	1021165	1021765	1061068	1063068
9,75	4	2,5	2120078	2122068	2150073	1021166	1021766	1061069	1063069
10,5	4	2,5	2120079	2122069	2150074	1021167	1021767	1061071	1063071
11	4,5	3	2120080	2122070	2150075	1021168	1021768	1061072	1063072
12	5,5	3	2120081	2122071	2150076	1021169	1021769	1061073	1063073
13,5	6	3	2120082	2122072	2150077	1021170	1021770	1061074	1063074
14,5	6	3	2120083	2122073	2150078	1021171	1021771	1061075	1063075
16	6	3	2120084	2122074	2150079	1021172	1021772	1061076	1063076



Relax

**KIT PISCINE ACQUAFORM
ACQUAFORM SWIMMING POOLS KIT**



**Mod.
RUBINO**

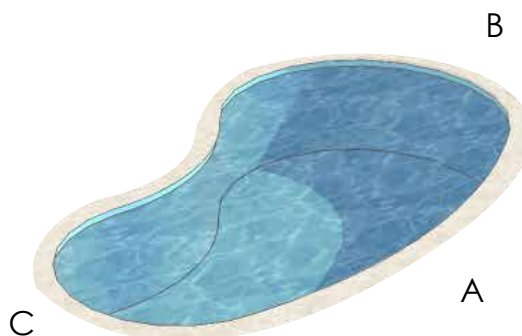

COMPONENTI DEL KIT / KIT COMPONENTS

Dimensioni [m]			Sup [m ²]	Volume [m ³]				Profondità [m]				Locale tecnico	Aspirazioni	Mand.	SK	BC	PS	PF	Filtro modello	Pompa [hp]	Portata [m ³ /h]
A	B	C		FP	FT	FP	FT	FP	FT	FP	FT										
8,20	4,0	3,0	28,5	34	37	43	45	1,20	1,80	1,50	2,00	Big Mac	n°2 Ø50	n°1 Ø50	1	2	-	1	medif. 500	0,75	10
9,20	4,0	3,0	28,5	34	37	43	45	1,20	1,80	1,50	2,00	Big Mac	n°2 Ø50	n°1 Ø50	1	2	-	1	medif. 500	0,75	10
10,60	5,0	4,0	44,0	53	58	66	70	1,20	1,80	1,50	2,00	Sedici	n°4 Ø50	n°3 Ø50	2	3	1	1	medif. 650	1	16
10,90	5,0	4,0	45,0	54	60	67,5	72	1,20	1,80	1,50	2,00	Sedici	n°4 Ø50	n°3 Ø50	2	3	1	1	medif. 650	1	16
12,50	6,0	5,0	62,5	75	83	94	101	1,20	1,80	1,50	2,00	Sedici	n°4 Ø50	n°3 Ø50	2	3	1	1	medif. 650	1	16

PREZZI KIT / KIT PRICES

Dim in m			Kit piscina 1,20 fondo piano	Kit piscina 1,20 fossa tuffi	Kit piscina 1,50 fondo piano	Bordo Bianco	Bordo Rosalind	Copertura isoter- mica estiva blu	Copertura invernale + tubolari
A	B	C	cod	cod	cod	cod	cod	cod	cod
8,2	4	3	2120085	2122075	2150080	1021177	1021577	1061082	1063082
9,2	4	3	2120086	2122076	2150081	1021178	1021578	1061083	1063083
10,6	5	4	2120087	2122077	2150082	1021179	1021579	1061084	1063084
10,9	5	4	2120088	2122078	2150083	1021180	1021580	1061085	1063085
12,5	6	5	2120089	2122079	2150084	1021181	1021781	1061086	1063086



Rubino

Per altri modelli consultare listino kit / For other models please consult the price list kit

EPS BLOK è il nuovo sistema di cassetta isoterma pre-formata in moduli dritti e già curvati, facile e veloce per il getto di piscine in calcestruzzo. EPS BLOK grazie alla sua leggerezza ed i suoi incastrati che lo rendono impilabile permette un facile trasporto e inoltre ha:

- proprietà isoterme che permettono di mantenere più a lungo la temperatura raggiunta dall'acqua
- maggiore semplicità nell'assemblare le pareti curve
- stampa in polistirene alta densità per pareti diritte e precurvate
- getto di calcestruzzo dosaggio fine densità C25/30

EPS BLOK is the new isothermal formwork system in straight and already curved modules, easy and fast for the casting of concrete pools. Thanks to its lightness and its joints that make it stackable, EPS BLOK allows an easy transport and it also has:

- isothermal properties that allow the pool to maintain the temperature reached by the water for longer
- greater simplicity in assembling curved walls
- molding high-density polystyrene for straight and pre-curved walls
- concrete jet fine density dosage C25/30

EPS BLOK 1000 MODULO DIRITTO / EPS BLOCK 1000 RECTANGULAR FORM

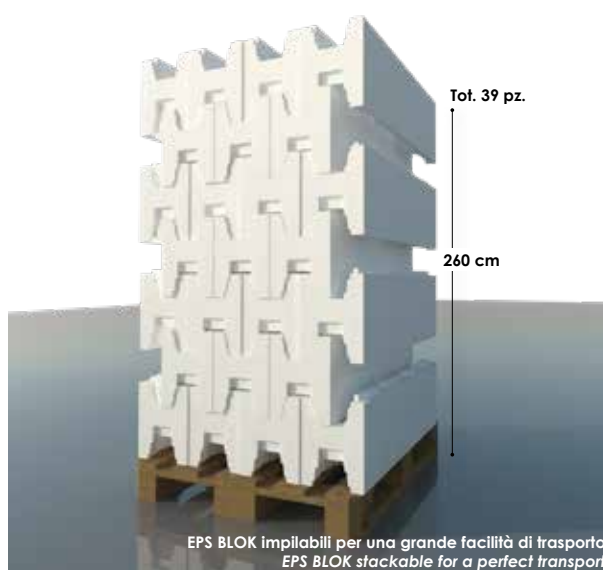
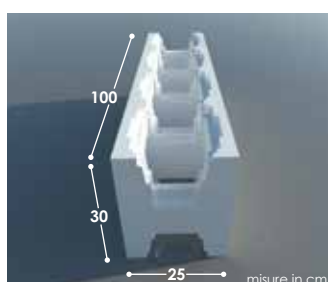
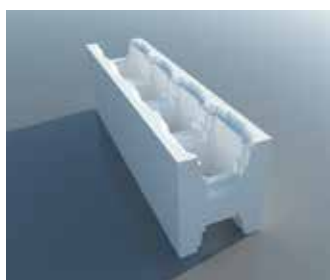

Codice/ code	Descrizione/description
1064000	EPS BLOK 1000 dritto in bancali da 39 pz. cadauno EPS BLOK1000 rectangular form in pallets of 39 pcs each
1064007	EPS BLOK 1000 dritto in pacchi da 9 pz. cadauno EPS BLOK1000 rectangular form in packages of 9 pcs each

CHIAVETTE DI TAMPONAMENTO ANGOLI / CORNER PLUGGING KEYS

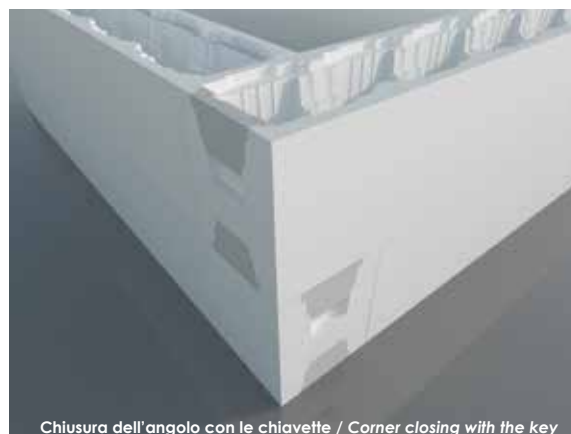
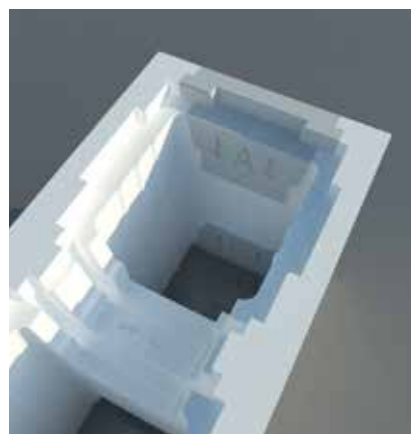
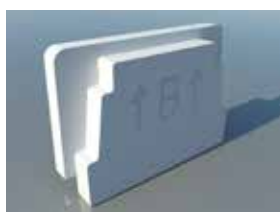
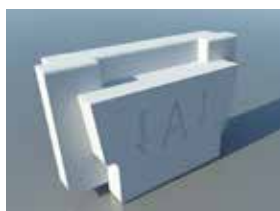

Chiusura dell'angolo con le chiavette / Corner closing with the key

Codice/ code	Descrizione/description
1064001	Box chiavette di tamponamento angoli A+B (25 pezzi A+25 pezzi B) Corner plugging keys box A+B (25 pcs A+25 pcs B)

EPS BLOK CURVA 90°
EPS BLOK 90° CURVE

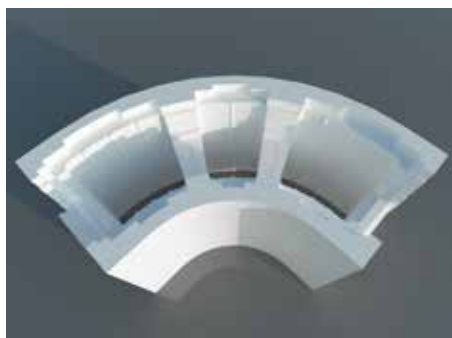
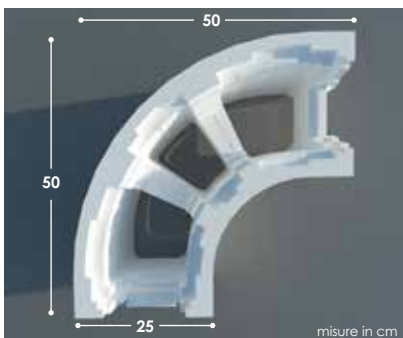

Codice/ code	Descrizione/description
1064002	EPS BLOK angolo 90° curvo / 90° curved corner EPS BLOK

EPS BLOK MODULI PRECURVATI
EPS BLOK PRE-CURVED MODULES

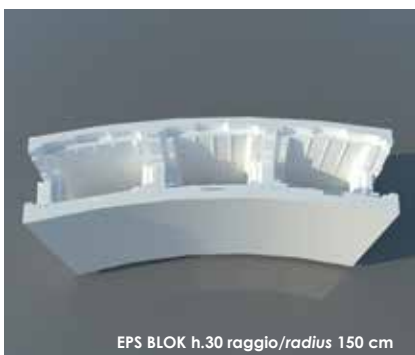

EPS BLOK h.30 raggio/radius 150 cm

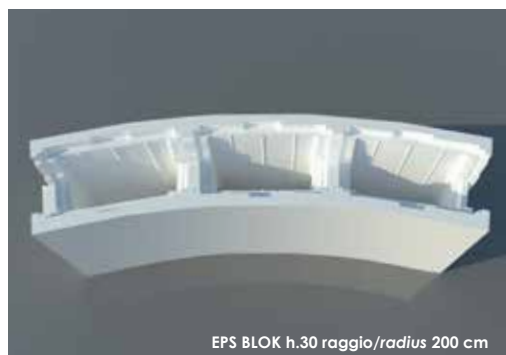

EPS BLOK h.30 raggio/radius 200 cm



Codice/ code	Descrizione/description
1064003	EPS BLOK precurvato raggio 150 / pre-curved shape EPS BLOK radius 150
1064004	EPS BLOK precurvato raggio 200 / pre-curved shape EPS BLOK radius 200

ALCUNE FORME REALIZZABILI IN EPS BLOK / EPS BLOK ACHIEVABLE SHAPES

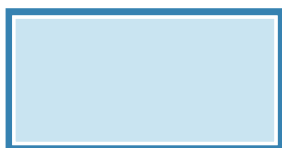

**EPS BLOK dritti +
chiavette di tamponamento**
Rectangular EPS BLOK + closing key



**EPS BLOK dritti +
chiavette di tamponamento**
Rectangular EPS BLOK + closing key



**EPS BLOK dritti e precurvati (raggio 150/200cm)
+ chiavette di tamponamento**
*Rectangular and precurved (radius 150/200cm)
EPS BLOK+ closing key*

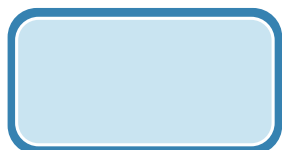

EPS BLOK dritti + EPS BLOK curva 90°
Rectangular EPS BLOK + 90° shape EPS BLOK



**EPS BLOK dritti + EPS BLOK precurvati
(raggio 150/200cm)**
*Rectangular EPS BLOK + precurved EPS BLOK
(radius 150/200cm)*

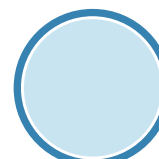

**EPS BLOK precurvati (raggio
150/200cm)**
Precurved EPS BLOK (radius 150/200cm)

SISTEMA DI COSTRUZIONE IN PANNELLI D'ACCIAIO BI PLASTIFICATI CONSTRUCTION SYSTEM IN BIPLASTIFIED STEEL PANELS

Pannello per skimmer/bocchetta MT3/MT14	Altezza 1,20 m	Altezza 1,50 m
	Codice	Codice
Pannello largo da 0 a 1 m pieno panel width from 0 to 1 m solid	4020200	4020300
Pannello largo da 0 a 1 m per bocchetta MT3 panel width from 0 to 1 m for return fitting MT3	4020201	4020301
Pannello largo da 0 a 1 m per skimmer MT3 panel width from 0 to 1 m for skimmer MT3	4020202	4020302
Pannello largo da 0 a 1 m per proiettore MT3 panel width from 0 to 1 m for projector MT3	4020203	4020303
Pannello largo da 0 a 1 m pieno pretagliato flessibile panel width from 0 to 1 m solid pre-cut flexible	4020204	4020304
Pannello largo da 0 a 1 m per bocchetta MT3 pretagliato flessibile panel width from 0 to 1 m for return fitting MT3 pre-cut flex	4020205	4020305
Pannello largo da 0 a 1 m per skimmer MT3 pretagliato flessibile panel width from 0 to 1 m for skimmer MT3 pre-cut flex	4020206	4020306
Pannello largo da 0 a 1 m per proiettore MT3 pretagliato flessibile panel width from 0 to 1 m for projector MT3 pre-cut flex	4020207	4020307
Pannello largo da 0 a 1 m pieno curvo panel width from 0 to 1 m solid curved	4020208	4020308
Pannello largo da 0 a 1 m per bocchetta MT3 curvo panel width from 0 to 1 m for return fitting MT3 curved	4020209	4020309
Pannello largo da 0 a 1 m per skimmer MT3 curvo panel width from 0 to 1 m for skimmer MT3 curved	4020210	4020310
Pannello largo da 0 a 1 m per proiettore MT3 curvo panel width from 0 to 1 m for projector MT3 curved	4020211	4020311

PANNELLO TWENTY/SEZIONI E ASSONOMETRIA AD INCASTRO

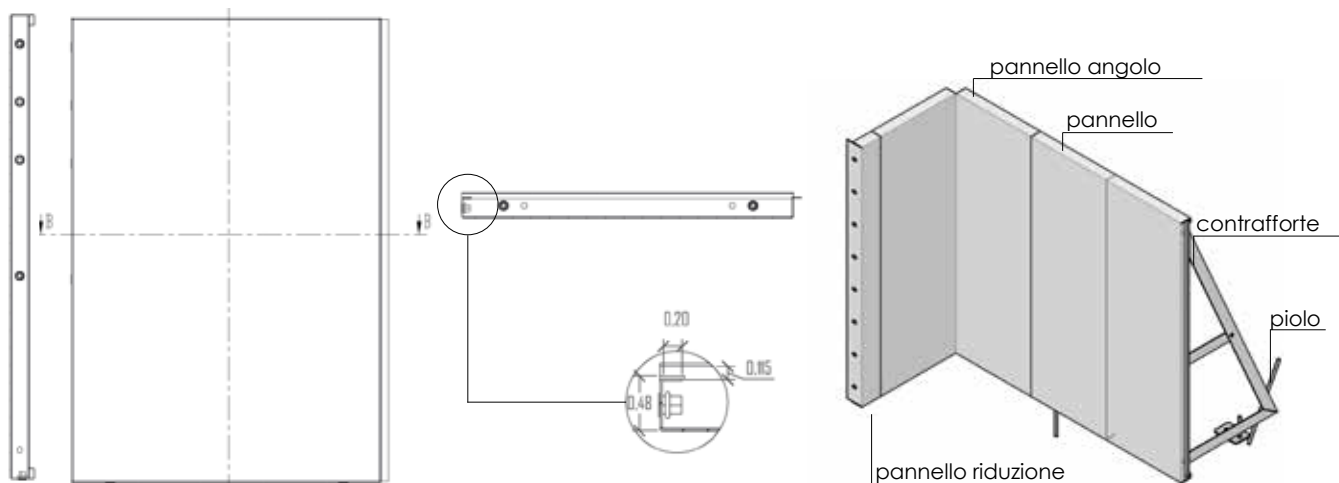

Pannello per skimmer/bocchetta REAL	Altezza 1,20 m	Altezza 1,50 m
	Codice	Codice
Pannello largo da 0 a 1 m per bocchetta REAL o proiettore panel width from 0 to 1 m for return fitting REAL or projector	4020252	4020366
Pannello largo da 0 a 1 m per skimmer REAL panel width from 0 to 1 m for skimmer REAL	4020253	4020367
Pannello largo da 0 a 1 m pretagliato flessibile per bocchetta REAL o proiettore panel width from 0 to 1 m pre-cut flex for return fitting REAL or projector	4020255	4020368
Pannello largo da 0 a 1 m pretagliato flessibile per skimmer REAL panel width from 0 to 1 m pre-cut flex for skimmer REAL	4020256	4020369
Pannello largo da 0 a 1 m curvo per bocchetta REAL o proiettore panel width from 0 to 1 m curved for return fitting REAL or projector	4020258	4020370
Pannello largo da 0 a 1 m curvo per skimmer REAL panel width from 0 to 1 m curved for skimmer REAL	4020259	4020371

Pannello per skimmer/bocchetta	Altezza 1,20 m	Altezza 1,50 m
	Codice	Codice
Pannello largo da 0 a 1 m per skimmer panel width from 0 to 1 m for skimmer	4020236	4020336
Pannello largo da 0 a 1 m per skimmer pretagliato flessibile panel width from 0 to 1 m skimmer pre-cut flex	4020237	4020337
Pannello largo da 0 a 1 m per skimmer curvo panel width from 0 to 1 m for skimmer curved	4020238	4020338
Pannello largo da 0 a 1 m per skimmer LX7 panel width from 0 to 1 m for skimmer LX7	4020239	4020339
Pannello largo da 0 a 1 m per skimmer LX7 pretagliato flessibile panel width from 0 to 1 m for skimmer LX7 pre-cut flex	4020240	4020340
Pannello largo da 0 a 1 m per skimmer LX7 curvo panel width from 0 to 1 m for skimmer LX7 curved	4020241	4020341

Pannello ad angoli e speciali/Corner panel and special	h120	h150
	Codice/code	Codice/code
Pannello ad angolo 50x50 / panel corner 50x50	4020212	4020312
Pannello speciale per raccordo scale vetroresina special panel for connecting fiberglass stairs	4020213	4020313
Profilo di giunzione angoli / profile corners junction	4020214	4020314
Contrafforte + piedino regolazione / buttress + adjustable foot	4020215	4020315
Tirante per piscine fuori terra / above ground pools tie	4020405	4020405
Pioli ancoraggio / anchoring pegs	4020108	4020108
Viti D 12x30 / screws D 12x30	1035831	1035831

BORDO SFIORO TWENTY BASSO TWENTY LOW OVERFLOW EDGE

Codice/ code	Descrizione/description
4020401	Bordo sfioratore basso diritto / low overflow edge straight
4020402	Bordo sfioratore basso tagliato per forma libera / low overflow edge cut for free form
4020403	Bordo sfioratore basso angolo 50x50 / corner 50x50 low overflow edge
4020404	Squadra di sostegno / support bracket
4030101	Giunzione per bordo sfioratore / overflow edge joint
4020111	Kit viti giunzione per bordo sfioratore / screws kit for overflow edge

KIT IN PANNELLI TWENTY - PISCINA CRETA TWENTY PANELS KIT - CRETA POOL



**Mod.
CRETA**

KIT CRETA SERIE 40 COMPLETO DI

Struttura completa di pannelli d'acciaio, relativi rinforzi laterali, zanche di fissaggio e bulloneria a completamento. Rivestimento interno in liner di PVC. Muro filtrante Ikarus già assemblato e pronto al funzionamento, non richiede interventi idraulici; completo di skimmer, bocchette di mandata acqua, filtro, pompa, raccorderia e tubazioni. Quadro elettrico con orologio di programmazione, scala in acciaio inox a 3 gradini antiscivolo.

CRETA KIT 40 SERIES COMPLETE OF

Structure complete with steel panels, side reinforcements, mounting brackets and bolts to complete. Liner in PVC. Filtering wall IKARUS already assembled and ready to operate, requires no plumbing, complete with skimmer, inlets water, filter, pump, pipe for the skimmer, fittings and pipes. Electrical panel with clock programming, stainless steel staircase with three anti-slip steps.

SERIE 40	Dim in m		Kit piscina 1,20 fondo piano	Kit piscina 1,20 fossa tuffi	Kit piscina 1,50 fondo piano	Bordo Bianco	Bordo Rosalind
	A	B	cod	cod	cod	cod	cod
	6	3	4020519	4020525	4020531	1021117	1021517
7	3	4020520	4020526	4020532	1021118	1021518	
8	4	4020521	4020527	4020533	1021119	1021519	
9	3	4020522	4020528	4020534	1021120	1021520	
9	4	4020523	4020529	4020535	1021121	1021521	
10	4	4020524	4020530	4020536	1021122	1021522	

KIT CRETA SERIE 50 COMPLETO DI / CRETA KIT 50 SERIES COMPLETE OF

- Struttura completa di pannelli in acciaio, relativi rinforzi laterali, zanche di fissaggio.
- Bulloneria a completamento.
- Rivestimento interno in membrana di PVC.
- Guida in alluminio per aggancio rivestimento.
- Locale tecnico in vetroresina pronto al funzionamento, filtro a sabbia con valvola a sei vie, elettropompa monofase con prefiltra, tubi di collegamento, valvole a sfera e raccorderia a completamento.
- Kit di tubazioni di collegamento, raccordi e colla.
- Skimmer, in aspirazione alla pompa completo di cestello raccogli impurità, aletta flottante, attacco per il troppo pieno.
- Bocchette di immissione acqua in piscina.
- Quadro elettrico con orologio per programmazione dei tempi di filtrazione della pompa, cavo di collegamento, cavo esterno con spina Schuko.
- Structure complete with steel panels, side reinforcements, fixing brackets.
- Bolts to complete.
- Inner coating in PVC membrane.
- Aluminium guide for hooking coating.
- Technical housing in fiberglass, ready to use, sand filter with six-way valve, single-phase electric pump with pre-filter, connecting pipes, ball valves and fittings to complete.
- Kit of connecting pipes, fittings and glue.
- Suction skimmer complete of basket, fin floating, overflow attack.
- Inlet fittings water in the pool.
- Electrical panel with clock for time programming filtration pump, connecting cable, external cable with Schuko plug.

SERIE 50	Dim in m			Kit piscina 1,20 fondo piano	Kit piscina 1,20 fossa tuffi	Kit piscina 1,50 fondo piano	Bordo Bianco	Bordo Rosalind
	A	B	C	cod	cod	cod	cod	cod
	8	4	-	4020410	4020427	4020444	1021119	1021519
9	3	-	4020411	4020428	4020445	1021120	1021520	
9	4	-	4020412	4020429	4020446	1021121	1021521	
10	4	-	4020413	4020430	4020447	1021122	1021522	
10	5	-	4020414	4020431	4020448	1021123	1021523	
11	5	-	4020415	4020432	4020449	1021124	1021524	
12	5	-	4020416	4020433	4020450	1021125	1021525	
12	6	-	4020417	4020434	4020451	1021126	1021526	
13	6	-	4020418	4020435	4020452	1021127	1021527	
14	5	-	4020419	4020436	4020453	1021128	1021528	
14	6	-	4020420	4020437	4020454	1021129	1021529	
14	7	-	4020421	4020438	4020455	1021130	1021530	
15	7	-	4020422	4020439	4020456	1021131	1021531	
16	7	-	4020423	4020440	4020457	1021132	1021532	
16	8	-	4020424	4020441	4020458	1021133	1021533	
18	9	-	4020425	4020442	4020459	1021134	1021534	
20	10	-	4020426	4020443	4020460	1021135	1021535	

KIT IN PANNELLI TWENTY - PISCINA JAMAICA

TWENTY PANELS KIT - JAMAICA POOL



Mod. JAMAICA

KIT JAMAICA SERIE 40 COMPLETO DI

Struttura completa di pannelli d'acciaio, relativi rinforzi laterali, zanche di fissaggio e bulloneria a completamento. Rivestimento interno in liner di PVC. Muro filtrante Ikarus già assemblato e pronto al funzionamento, non richiede interventi idraulici; completo di skimmer, bocchette di mandata acqua, filtro, pompa, raccorderia e tubazioni. Quadro elettrico con orologio di programmazione, scala in acciaio inox a 3 gradini antiscivolo.

JAMAICA KIT SERIES 40 COMPLETE OF

Structure complete with steel panels, side reinforcements, fixing brackets and bolts. Inner lining in PVC. IKARUS filter wall already assembled and ready to operate, it does not require hydraulic interventions; complete with skimmer, water inlet fittings, filter, pump, fittings and pipelines. Electric panel with programming clock, stainless steel staircase with three anti-slip steps.

SERIE 40	Dim in m			Kit piscina 1,20 fondo piano	Kit piscina 1,20 fossa tuffi	Kit piscina 1,50 fondo piano	Bordo Bianco	Bordo Rosalind
	A	B	scala	cod	cod	cod	cod	cod
	6,75	3	200	4020537	4020541	4020545	1021204	1021704
7,75	3	200	4020538	4020542	4020546	1021205	1021705	
8,95	4	250/300	4020539	4020543	4020547	1021206	1021706	
9,95	4	250/300	4020540	4020544	4020548	1021207	1021707	

KIT JAMAICA SERIE 50 COMPLETO DI / KIT COMPLETE OF

- Struttura completa di pannelli in acciaio, relativi rinforzi laterali, zanche di fissaggio.
- Bulloneria a completamento.
- Rivestimento interno in membrana di PVC.
- Guida in alluminio per aggancio rivestimento.
- Locale tecnico in vetroresina pronto al funzionamento, filtro a sabbia con valvola a sei vie, elettropompa monofase con prefiltro, tubi di collegamento, valvole a sfera e raccorderia a completamento.
- Kit di tubazioni di collegamento, raccordi e colla.
- Skimmer, in aspirazione alla pompa completo di cestello raccogli impurità, aletta flottante, attacco per il troppo pieno.
- Bocchette di immissione acqua in piscina.
- Quadro elettrico con orologio per programmazione dei tempi di filtrazione della pompa, cavo di collegamento, cavo esterno con spina Schuko.
- Structure complete with steel panels, side reinforcements, fixing brackets.
- Bolts made to complete the structure.
- Inner lining in PVC membranwe.
- Aluminium guide for securing the covering.
- Ready to use technical housing in fiberglass, sand filter with six-way valve, single-phase electric pump with pre-filter, connecting pipes, ball valves and fittings.
- Kit of connecting pipes, fittings and glue.
- Skimmer, for pump suction complete with basket to collect impurities, floating wing, connection for overflow.
- Water inlet fittings in the swimming pool.
- Electric panel with clock to program the pump filtration, connecting cable, external cable with Schuko plug.

SERIE 50	Dim in m			Kit piscina 1,20 fondo piano	Kit piscina 1,20 fossa tuffi	Kit piscina 1,50 fondo piano	Bordo Bianco	Bordo Rosalind
	A	B	compre- sivo di scala	cod	cod	cod	cod	cod
	6,75	3	200	4020461	4020472	4020483	1021204	1021704
7,75	3	200	4020462	4020473	4020484	1021205	1021705	
9,39	4	250	4020463	4020474	4020485	1021206	1021706	
10,39	4	250	4020464	4020475	4020486	1021207	1021707	
11,25	5	300	4020465	4020476	4020487	1021208	1021708	
11,39	4	250	4020466	4020477	4020488	1021209	1021709	
12,25	5	300	4020467	4020478	4020489	1021210	1021710	
13,25	6	300	4020468	4020479	4020490	1021211	1021711	
14,25	6	300	4020469	4020480	4020491	1021212	1021712	
15,25	6	300	4020470	4020481	4020492	1021213	1021713	
17,25	6	300	4020471	4020482	4020493	1021214	1021714	

KIT IN PANNELLI TWENTY - PISCINA JAKE TWENTY PANELS KIT - JAKE POOL



KIT JAKE SERIE 40 COMPLETO DI / KIT COMPLETE OF

Struttura completa di pannelli d'acciaio, relativi rinforzi laterali, zanche di fissaggio e bulloneria a completamento. Rivestimento interno in liner di PVC. Muro filtrante Ikarus già assemblato e pronto al funzionamento, non richiede interventi idraulici; completo di skimmer, bocchette di mandata acqua, filtro, pompa, raccorderia e tubazioni. Quadro elettrico con orologio di programmazione, scala in acciaio inox a 3 gradini antiscivolo.

JAKE KIT SERIES 40 COMPLETE OF

Structure complete with steel panels, side reinforcements, mounting brackets and bolts to complete. Liner in PVC. Filtering wall IKARUS already assembled and ready to operate, requires no plumbing, complete with skimmer, inlets water, filter, pump, pipe for the skimmer, fittings and pipes. Electrical panel with clock programming, stainless steel staircase with three anti-slip steps.

SERIE 40	Dim in m			Kit piscina	Kit piscina	Kit piscina	Bordo Bianco	Bordo Rosalind
	A	B	C	1,20 fondo piano	1,20 fossa tuffi	1,50 fondo piano		
				cod	cod	cod	cod	cod
	6,45	3,5	3	4020549	4020554	4020559	1021155	1021562
	7,5	4	3	4020550	4020555	4020560	1021163	1021555
	8,5	4	3	4020551	4020556	4020561	1021156	1021563
	9,5	4	3	4020552	4020557	4020562	1021157	1021564
	10,5	5	4	4020553	4020558	4020563	1021158	1021565

KIT JAKE SERIE 50 COMPLETO DI / JAKE KIT SERIES 40 COMPLETE OF

- Struttura completa di pannelli in acciaio, relativi rinforzi laterali, zanche di fissaggio.
- Bulloneria a completamento.
- Rivestimento interno in membrana di PVC.
- Guida in alluminio per aggancio rivestimento.
- Locale tecnico in vetroresina pronto al funzionamento, filtro a sabbia con valvola a sei vie, elettropompa monofase con prefiltro, tubi di collegamento, valvole a sfera e raccorderia a completamento.
- Kit di tubazioni di collegamento, raccordi e colla.
- Skimmer, in aspirazione alla pompa completo di cestello raccogli impurità, aletta flottante, attacco per il troppo pieno.
- Bocchette di immissione acqua in piscina.
- Quadro elettrico con orologio per programmazione dei tempi di filtrazione della pompa, cavo di collegamento, cavo esterno con spina Schuko.
- Complete structure with steel panels, side reinforcements, mounting brackets.
- Bolts to completion.
- Inner coating in PVC membrane.
- Aluminium guide for hooking coating.
- Technical housing in fiberglass, sand filter with six-way valve, single-phase electric pump with pre-filter, connecting pipes, ball valves and fittings to completion.
- Kit of connecting pipes, fittings and glue.
- Suction skimmer complete of basket, fin floating, overflow attack.
- Inlet fittings water in the pool.
- Electrical panel with clock for time programming filtration pump, connecting cable, external cable with Schuko plug.

SERIE 50	Dim in m			Kit piscina	Kit piscina	Kit piscina	Bordo Bianco	Bordo Rosalind
	A	B	C	1,20 fondo piano	1,20 fossa tuffi	1,50 fondo piano		
				cod	cod	cod	cod	cod
	6,25	3,5	3	4020494	4020503	4020511	1021155	1021562
	8,25	4	3	4020495	4020504	4020512	1021156	1021563
	9,5	4	3	4020496	4020505	4020513	1021157	1021564
	10,5	5	4	4020497	4020506	4020514	1021158	1021565
	12	7	5	4020498	4020507	4020515	1021159	1021566
	13	7	5	4020499	4020508	4020516	1021160	1021567
	16	9	7	4020501	4020509	4020517	1021161	1021568

GARDEN



Piscina in vetroresina ideale per piccoli spazi o ambienti interni.

Viene fornita completa di locale tecnico MAC 6 con:

- 1 pompa di filtrazione 0,37 kW monofase
- 1 filtro a sabbia
- 1 quadro di comando con pianificazione delle fasce orarie di filtrazione
- 1 skimmer, 2 bocchette di immissione, 1 faro led bianco.
- Kit nuoto contro corrente per la VERSIONE PRESTIGE

Fiberglass pool ideal for small spaces or indoors. It is supplied complete with technical housing MAC 6 with:

- 1 filtration pump 0,37 kW mono-phase
- 1 sand filter
- 1 control panel with planning filtration slots
- 1 skimmer, 2 return fitting, 1 led white projector
- swimming against current KIT for PRESTIGE VERSION



illuminazione led
led lighting



nuoto controcorrente
(ver. PRESTIGE)
counter-current swimming
(PRESTIGE ver.)

DIMENSIONI / DIMENSIONS:

- Lunghezza interna: 4,66 m
- Larghezza interna: 2,10 m
- Lunghezza esterna: 5,04 m
- Larghezza esterna: 2,40 m
- Altezza: 1,39 m
- Internal length: 4,66 m
- Internal width: 2,10 m
- External length: 5,04 m
- External width: 2,40 m
- Height: 1,39 m

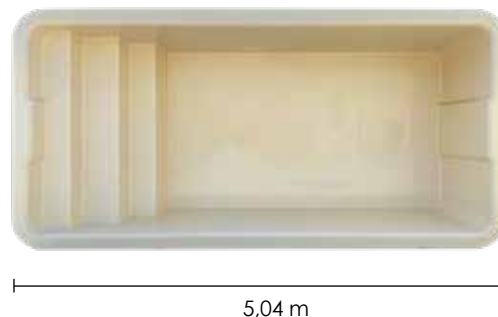

COLORI / COLOURS



Grigio
Grey



Sabbia
Sand



Bianco
White



Azzurro chiaro
Light blue

Codice / code	Descrizione / description
8200141	Garden - non accessoriata / Garden - not equipped
8200142	Garden standard (loc. tecnico completo, skimmer, bocchette, faro)
8200143	Garden prestige (completa) / Garden prestige (full optional)
OPZIONI / OPTIONS	
8200125	Kit bordi Espace piatto colore sabbia / Espace flat edges kit sand colour
8200126	Kit bordi Espace piatto colore grigio / Espace flat edges kit grey colour
8200145	Copertura isotermica a bolle / Bubble cover
8200146	Copertura invernale con occhielli perimetrali e corda elastica / Winter cover with perimeter eyelets and elastic cord

LIBERTY SPA



La Liberty SPA si adatta perfettamente a piccoli spazi. Le sue dimensioni compatte facilitano la sua integrazione e installazione all'esterno come all'interno, pur mantenendo i vantaggi di una piscina tradizionale. La Liberty SPA è un concentrato di tecnologia, equipaggiata per il vostro benessere con:

- Nuoto contro corrente
- 2 sedute idromassaggio
- 2 chaise longue idromassaggio
- Sistema automatico di riscaldamento
- dimensioni nominali: 2,28 x 4,94 x 1,34 m

Liberty SPA perfectly adapts to small spaces. Its compact dimensions facilitate its integration and installation outside as inside, while maintaining the advantages of a traditional swimming pool. Liberty SPA is a combination of technology, equipped for your well-being with:

- Counter-current swimming
- 2 hydromassage seats
- 2 hydromassage chaise longue
- Automated heating system
- Nominal size: 2,28 x 4,94 x 1,34 m



sedute
seats



lettino
lounger

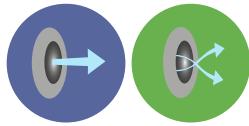

getti d'acqua
water jets



getti d'aria
air jets



nuoto controcorrente
counter-current swimming



illuminazione led
led lighting



Le immagini hanno puro scopo illustrativo
The images have illustration purpose only

Codice/ Code	Descrizione/Descrizione
8200151	Liberty SPA prestige - completa (vd. tabella equipaggiamento) / Full optional (see equipment table)
OPZIONI / options	
8200253	Pannellatura perimetrale / Perimeter paneling
8200193	Copertura rigida SPA Liberty / Hard cover SPA Liberty

EQUIPAGGIAMENTO / EQUIPMENT	
IDROMASSAGGIO-NUOTO CONTROCORRENTE / HYDROMASSAGE COUNTER-CURRENT SWIMMING	
2 Sedute idromassaggio / 2 hydromassage seats 2 Lettini massaggio aria / 2 air massage loungers	
2 pompe idromassaggio 2 cv 2 hydromassage pumps 2 cv	
1 pompa NCC 3 cv, 40 m³/h 1 counter-current pump 3 cv, 40 m³/h	
1 blower 0,9 kW massaggio aria 1 blower 0,9 kW air massage	
FILTRAZIONE / FILTRATION	
1 skimmer, 2 bocchette / 1 skimmer, 2 return fittings	
1 locale tecnico / 1 technical housing	
1 pompa di filtrazione / 1 filtration pump	
1 filtro a cartuccia / 1 cartridge filter	
1 quadro di comando con pianificazione delle fasce orarie di filtrazione con riscaldatore elettrico 1 control panel with planning filtration slots with electrical heater	
1 pannello di comando / 1 control panel	
ACCESSORI / ACCESSORIES	
1 proiettore a LED / 1 LED projector	
ASSORBIMENTI / power consumption	
Alimentazione monofase o trifase su richiesta / Single-phase or three-phase power on request	
Filtrazione e Riscaldamento [kW] Filtration and heating	4,1
Idromassaggio / Hydromassage [kW]	6,2
Max [kW]	6,2

COLORI / COLOURS



Bianco
White



Copertura rigida SPA Liberty
Hard cover for SPA Liberty
code 8200193



PISCINA INDIPENDENTE MEDITERRANEA INDEPENDENT MEDITERRANEA POOL



MEDITERRANEA è la piscina INDIPENDENTE che:

- grazie alla sua struttura modulare permette un'installazione idonea su ogni tipo di terreno
- è realizzata con un sistema modulare di pannelli di acciaio zincato; ha un rivestimento in PVC presaldato che ne garantisce la durata negli anni ed una perfetta finitura estetica
- è fornita di locale tecnico completo e pre-equipaggiato posizionato nella testata della piscina
- è possibile infatti accessoriarla con kit nuoto controcorrente, sistemi d'illuminazioni LED RGB
- nella fornitura del kit Mediterraneo i bordi sono esclusi

MEDITERRANEA the new INDEPENDENT pool that:

- thanks to its structure allows an easy installation on all types of ground, without structural work
- it's made with a modular galvanized steel panels system and a PVC coating welded in place that guarantees the duration and a perfect aesthetic finish
- it is equipped with a complete and pre-equipped technical room positioned in the head of the pool
- it can be equipped with counter-current swimming kit and LED RGB lighting system
- in the supply of the Mediterranean kit the edges are excluded



INDIPENDENTE
INDEPENDENT



SENZA OPERE EDILI
NO STRUCTURAL WORK



FACILE DA MONTARE
EASY TO INSTALL



ADATTA AD OGNI TERRENO
EASY TO FIX ON EVERY GROUND



PERSONALIZZABILE
CUSTOMIZABLE

KIT FORNITO COMPLETO DI IMPIANTO, ACCESSORI E QUADRO ELETTRICO COMPLETE KIT WITH POOL EQUIPMENT, ACCESSORIES AND ELECTRICAL PANEL



Kit fornito completo d'impianto, accessori e quadro elettrico.

Questa piscina presenta un rivestimento esterno in lamiera verniciata a caldo. È immune a qualsiasi tipo di aggressione esterna: da quelle naturali come insetti, termiti, funghi e altri microrganismi, pioggia, grandine, neve e raggi UV. Il bacino, grazie al rivestimento in PVC presaldato è immune agli acidi diluiti e soluzioni saline o clorate. Non ha bisogno di manutenzione nel tempo.

Complete Kit with pool equipment, accessories and electrical panel.

This pool has an external coating in hot-painted sheet. It's absolutely immune to any type of external aggression: from natural ones such as insects, termites, fungi and other microorganisms, rain, hail, snow and UV rays. The basin, thanks to the pre-welded PVC coating, is immune to diluted acids and saline or chlorinated solutions. It does not need maintenance over time.

COLORI LINER / LINERS COLOURS



COLORI PANNELLI LATERALI / SIDE PANELS COLOURS

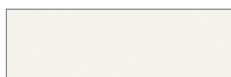

Bianco 9010 - KIT STANDARD
White - STANDARD KIT

PROIETTORE PIATTO / FLAT PROJECTOR

su richiesta
on request



Da avvitare su bocchetta. Corpo proiettore realizzato in policarbonato ed ABS con elevata resistenza a shock, calore ed aggressioni chimiche dei prodotti per il trattamento dell'acqua.

To be screwed on a return fitting. Projector-body made of polycarbonate and ABS with high resistance to shock, heat and chemical attack of water treatment products.



Cod. 1070229



Cod. 1070227



Cod. 1070228



Cod. 1070226



Cod. 1070211

SCALE / LADDERS

su richiesta
on request



Cod. 1025100 - scala Ponte doppia
Cod. 1025100 - Double ladder

Fabbricate in tubo d'acciaio inossidabile 304 - diametro Ø 43 mm.
Made with tube Ø 43 mm in stainless steel 304.

DIMENSIONI DISPONIBILI / AVAILABLE DIMENSIONS

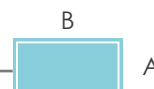

Dimensioni interne Internal dimensions [m]		Dimensioni esterne External dimensions [m]			Equipaggiamento Equipment			
A	B	A	B	Altezza Height [m]	Faro Lamp [n°]	Filtro a sabbia Sand Filter [mm]	Pompa Pump [hp]	Rivestimento Membrane
3	3	3,60	4,10	1,25	1	Ø 500	0,5	Liner
3	4,5	3,60	5,60	1,25	1	Ø 500	0,5	Liner
3	6	3,60	7,10	1,25	1	Ø 500	0,5	Liner
3	7,5	3,60	8,60	1,25	1	Ø 500	0,5	Liner
3	9	3,60	10,10	1,25	1	Ø 500	0,5	Liner
3	10,50	3,60	11,60	1,25	1	Ø 500	0,5	Liner
4	3	4,60	4,10	1,25	1	Ø 500	0,5	Liner
4	4,5	4,60	5,60	1,25	1	Ø 500	0,5	Liner
4	6	4,60	7,10	1,25	1	Ø 500	0,5	Liner
4	7,5	4,60	8,60	1,25	1	Ø 500	0,5	Liner
4	9	4,60	10,10	1,25	1	Ø 500	0,5	Liner
4	10,50	4,60	11,60	1,25	1	Ø 500	0,5	Liner

Per la quotazione della piscina Mediterranea fare riferimento al listino dedicato
For the Mediterranea quotation please refer to the dedicated price list

BORDO SFIORO STANDARD / STANDARD OVERFLOW EDGE



Codice/ Code	Descrizione/Descrizione
1020590	Bordo sfioro sezione diritta / Overflow edge straight section
1020591	Bordo sfioro sezione diritta con piletta Ø100 / Overflow edge straight section with drain
1020685	Bordo sfioro sezione diritta con terminale / Overflow edge straight section with terminal
1020592	Bordo sfioro sezione angolo retto / Overflow edge section 90°
1020593	Bordo sfioro sezione angolo retto rovescio / Overflow edge section 90° backhand

Bordo sfioro a raggio/overflow edge radius section:



Descrizione/Descrizione								
Bordo sfioro sezione a raggio / Overflow edge radius section								
Codice	1020610	1020611	1020612	1020613	1020614	1020615	1020686	1020697
Raggio	1,50	2,00	2,50	3,00	4,00	5,00	6,00	7,00

Descrizione/Descrizione								
Bordo sfioro sezione a raggio con piletta / Overflow edge radius section with drain								
Codice	1020618	1020619	1020620	1020621	1020622	1020623	1020687	1020698
Raggio	1,50	2,00	2,50	3,00	4,00	5,00	6,00	7,00

Descrizione/Descrizione		
Bordo sfioro sezione a raggio rovescio / Overflow edge radius section backhand		
Codice	1020688	1020689
Raggio	1,00	3,50

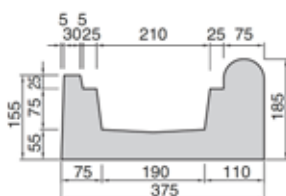

BORDO SFIORO FINLANDESE / FINNISH OVERFLOW EDGE

Per uno sfioro ottimale è d'obbligo rasare la parte superiore
For an optimal overflow it is mandatory to shave the top



Codice/ Code	Descrizione/Descrizione
1020597	Bordo sfioro finlandese sezione diritta / Finnish overflow edge straight section
1020598	Bordo sfioro finlandese sezione diritta con piletta Ø100 / Straight section with drain
1021610	Bordo sfioro finlandese sezione diritta con terminale/Finnish overflow edge straight section with terminal
1020599	Bordo sfioro finlandese sezione angolo retto / Edge section 90°
1020562	Bordo sfioro finlandese sezione angolo retto rovescio / Section 90° backhand

Descrizione/Descrizione								
Bordo sfioro finlandese sezione a raggio / Radius section								
Codice	1020632	1020633	1020634	1020635	1020636	1020637	1020703	1020702
Raggio	1,50	2,00	2,50	3,00	4,00	5,00	6,00	7,00

Descrizione/Descrizione								
Bordo sfioro finlandese sezione a raggio con piletta / Radius section with drain								
Codice	1020640	1020641	1020642	1020643	1020644	1020645	1020704	1020705
Raggio	1,50	2,00	2,50	3,00	4,00	5,00	6,00	7,00

Descrizione/Descrizione		
Bordo sfioro finlandese sezione a raggio rovescio / Radius section backhand		
Codice	1020741	1020742
Raggio	1,00	3,50

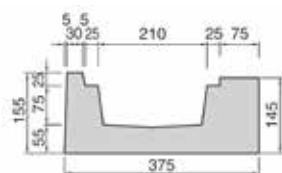

**BORDO SFIORO SPIAGGIA
BEACH OVERFLOW EDGE**

In agglomerato cemento graniglia larghezza 38 cm, lunghezza 50 cm, altezza 16 cm.
In agglomerated cement grit width 38 cm, length 50 cm, height 16 cm.

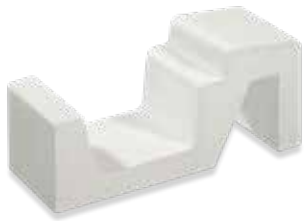

Codice/ Code	Descrizione/Descrizione
1020743	Bordo sfioro Spiaggia sezione diritta Beach overflow edge straight section
1020744	Bordo sfioro Spiaggia sezione diritta con piletta Beach overflow edge straight section with drain
1020745	Bordo sfioro Spiaggia sezione diritta con terminale Beach overflow edge straight section with terminal
1020746	Bordo sfioro Spiaggia sezione angolo retto Beach overflow edge section 90°
1020747	Bordo sfioro Spiaggia sezione angolo retto rovescio Beach overflow edge section 90° backhand
1020748	Bordo sfioro Spiaggia sezione a raggio / raggio rovescio Beach overflow edge section radius / backhand radius
1020749	Bordo sfioro Spiaggia sezione raggio / raggio rovescio con piletta Beach overflow edge section radius / backhand radius w/drain

GRIGLIA MASTER - DIRITTA E CURVABILE / MASTER GRID - STRAIGHT AND CURVED



Codice/ code	Descrizione/description
1065200	Griglia Master diritta in polipropilene largh.247,5 mm -sp 25 mm Straight grid in PP width 247.5 mm -sp 25 mm
1065201	Griglia Master curvabile in polipropilene largh.247,5 mm -sp 25 mm Curved grid in PP width 247.5 mm -sp 25 mm

GRIGLIA IN ABS CURVABILE / CURVED GRID IN ABS



Codice/ Code	Descrizione/Descrizione	
1065238	Griglia in ABS curvabile larghezza 245 mm - sp 30 mm Grid in ABS curved	al m
1065240	Griglia in ABS curvabile larghezza 295 mm - sp 30 mm Grid in ABS curved	al m

GRIGLIA IN POLIPROPILENE CURVABILE / POLYPROPYLENE CURVED GRID

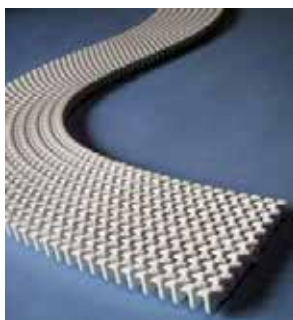

Cod.1065312-1065313-1065314-1065315

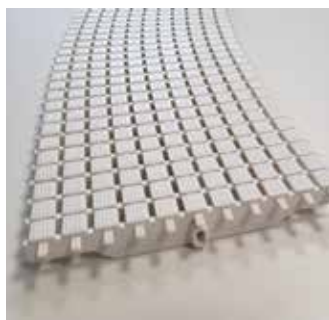

Cod. 1065317

Rispetta la normativa UNI EN 13451-1 (8 mm) / La GR47 si può realizzare colorata su richiesta: quantità minima 50 m, maggiorazione prezzo 20%, tempo di consegna 30 giorni.

Complies the UNI EN 13451-1 (8mm) rules GR47 one can be colored on request: minimum quantity 50 meters, 20% price increase, delivery time 30 days.

Codice/code	Descrizione/description	
1065312	Griglia curvabile FS47 in polipropilene largh. 180 mm - sp 25 mm Curved grid in PP	al m
1065313	Griglia curvabile FS47 in polipropilene largh. 200 mm - sp 25 mm Curved grid in PP	al m
1065314	Griglia curvabile FS47 in polipropilene largh. 250 mm - sp 25 mm Curved grid in PP	al m
1065315	Griglia curvabile FS47 in polipropilene largh. 300 mm - sp 25 mm Curved grid in PP	al m
1065317	Griglia curvabile FS90 in polipropilene largh. 245 mm - sp 22 mm Curved grid in PP	al m

GRIGLIA SABBIAIA / SANDBLASTED GRID



Per una corretta posa e utilizzo è indispensabile trattare con un trattamento impregnante di protezione.

For a correct installation and use, it is essential to treat with a protective impregnating treatment.

Codice BIANCO/ code WHITE	Codice GIALLO/code YELLOW	Descrizione/description
1020045	1020552	Griglia sabbiaia 50x24,9 cm* / Blast grid 50 cm*
1020043	1020566	Griglia sabbiaia ad angolo* / Blast edge grid*
1020569	1020567	Griglia sabbiaia a raggio* / Blast radius grid*

*Specificare in fase di ordine il modello richiesto: A, B o C

*Specify the required model when ordering: A, B or C

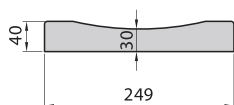

A - sfioro spiaggia
A - beach overflow

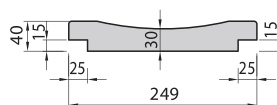

B - sfioro standard
B - standard overflow

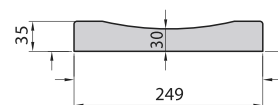

modello C
C model

PLACCHE AD ANGOLO PER GRIGLIA / CORNER PLATES FOR GRID



Codice/ code	Descrizione/description
1065320	Placca angolo 90° larghezza 195 mm – sp 22 mm / Angle 90°
1065206	Placca angolo 90° larghezza 245 mm – sp 22 mm / Angle 90°
1065322	Placca angolo 90° larghezza 295 mm – sp 22 mm / Angle 90°
1065338	Placca angolo 90° larghezza 195 mm – sp 35 mm / Angle 90°
1065241	Placca angolo 90° larghezza 245 mm – sp 35 mm / Angle 90°
1065243	Placca angolo 90° larghezza 295 mm – sp 35 mm / Angle 90°
1065340	Placca angolo 90° larghezza 335 mm – sp 35 mm / Angle 90°
1065330	Placca angolo 45° larghezza 195 mm – sp 22 mm / Angle 45°
1065209	Placca angolo 45° larghezza 245 mm – sp 22 mm / Angle 45°
1065332	Placca angolo 45° larghezza 295 mm – sp 22 mm / Angle 45°
1065339	Placca angolo 45° larghezza 195 mm – sp 35 mm / Angle 45°
1065333	Placca angolo 45° larghezza 245 mm – sp 35 mm / Angle 45°
1065334	Placca angolo 45° larghezza 295 mm – sp 35 mm / Angle 45°
1065335	Placca angolo 45° larghezza 335 mm – sp 35 mm / Angle 45°

PLACCHE AD ANGOLO PER GRIGLIA FS47 E FS90 CORNER PLATES FOR FS47, FS90 GRID

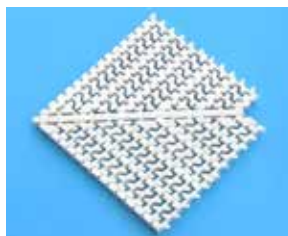

Cod. 1065318 - 1065319 - 1065311

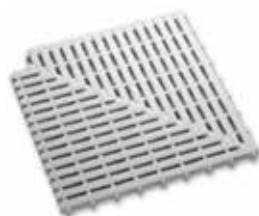

Cod. 1065236

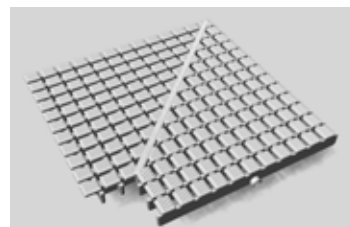

Cod. 1065316

Codice/code	Descrizione/description
1065318	Placca ad angolo griglia FS47 da 18 cm - sp 25 mm / Angle 90° for grid FS47 18 cm
1065319	Placca ad angolo griglia FS47 da 20,5 cm - sp 25 mm / Angle 90° for grid FS47 20,5 cm
1065311	Placca ad angolo griglia FS47 da 25 cm - sp 25 mm / Angle 90° for grid FS47 25 cm
1065236	Placca ad angolo 90° da 261 mm a 370 mm - sp 25 mm / Angle 90° from 261 mm to 370 mm*
1065316	Placca ad angolo 90° FS90 da 24,5 cm - sp 22 mm / Angle 90° for grid FS90 24,5 cm

*Adatta per griglia FS47 larghezza 300 mm / *Suitable for FS47 grid width 300 mm

VASCHE DI COMPENSO E ACCESSORI / OVERFLOW TANKS AND ACCESSORIES



VASCA DI COMPENSO ATLANTIC
dim. 2,36x2,46x1,60h m



VASCA DI COMPENSO GLOBO
dim. 2,24x1,88x1,15h m

Codice/ code	Descrizione/description
1065110	Vasca di compenso mod. GLOBO X4000LT. Dimensioni vasca di compenso: 2,24x1,88x1,15h. completa di coperchio apertura totale in due punti per facilitare la pulizia. Quadro con sonde tre livelli, elettrovalvola 24 V Ø1", passante VDL troppo pieno 63x75x2" 1/2, passante ricevimento canali di sfioro acqua 90x110, due aspirazioni pompa Ø63 Overflow tank mod. GLOBE X4000LT. Size: 2.24 x 1.88x1, 15h. complete with cover, total opening in 2 points to facilitate cleaning. Probes three levels, solenoid valve 24 V Ø1", passing VDL overflow 63x75x2" 1/2, passing receipt overflow channels 90x110, 2 suction pump Ø63
1065111	Vasca di compenso mod. ATLANTIC - capacità 8.5 m3. Dimensioni vasca di compenso: 2,36x2,46x1,60h. Completa di coperchio apertura totale in due punti per facilitare la pulizia. Quadro con sonde tre livelli, elettrovalvola 24 V Ø1", passante VDL troppo pieno 63x75x2" 1/2, passante ricevimento canali di sfioro acqua 90x110, due aspirazioni pompa Ø63 Overflow tank mod. ATLANTIC - capacity: 8.5 m3. Overflow tank size: 2.36 x 2, 46x1, 60h. Complete with cover, total opening at two points to facilitate cleaning. Probes three levels, solenoid valve 24 V Ø1", passing VDL overflow 63x75x2" 1/2, passing receipt overflow channels 90x110 water, two suction pump Ø63

Codice/ code	Descrizione/description
1041330	Modulo sonda livello acqua con 3 elettrodi / Sensor module water level with 3 electrodes
1041335	Elettrovalvola 1" - 24 VAC con regolatore di flusso / Solenoid valve 1" with flow - 24 VAC
1041336	Elettrovalvola 1" 1/2 - 24 VAC con regolatore di flusso / Solenoid valve 1 1/2 " with flow - 24 VAC
1041337	Elettrovalvola 2" - 24 VAC con regolatore di flusso / Solenoid valve 2" with flow - 24 VAC
1070058	Bocchetta con griglia 2" Ø63 con 30 cm tubo troppo pieno / Plate with grid 2" Ø63 with 30 cm of overflow pipe
ACCESSORI PRE - ASSEMBLATI	
1070081	Pozzetto di fondo antivortex c/tubo flessibile Ø50 Ground drainage antivortex c/flexible pipe Ø50
1070082	Pozzetto di fondo antivortex c/tubo flessibile Ø63 Ground drainage antivortex c/flexible pipe Ø63

KIT COLONNA DI CONTROLLO LIVELLO VASCA DI COMPENSO Ø 63

Codice/ code	Descrizione/description
1041325	Completa di 2 m di tubo trasparente + 1 bocchetta di presa RL-319 + 1 gomito + T femmina + 1 calotta femmina + valvola a sfera + 2 collari / Complete with 2 m of transparent hose + 1 outlet RL-319-1 + elbow + T female + female cap + ball valve + 2 collars

SCALE IN ACRILICO - ACRYLIC STAIRS

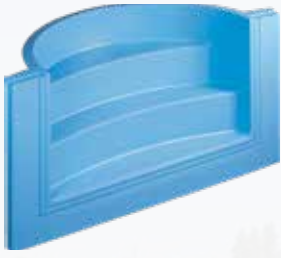

SCALA ROMANA
ROMAN STAIR



SCALA BALNEO
BALNEO STAIR



SCALA SOFA
SOFA STAIR



SCALA OPERA
OPERA STAIR



SCALE SOTTO LINER - UNDER LINER STAIRS



SCALA ROMANA
ROMAN STAIR



SCALA RELAX
RELAX STAIR



SCALA AD ANGOLO
CON SEDUTA
ANGLED STAIRS WITH SEAT



SCALA AD ANGOLO
CON SEDUTA
ANGLED STAIRS
WITH SEAT



SCALA AD ANGOLO
ANGLED STAIR



SCALA CIRCOLARE
ROUND STAIR



SCALA DRITTA
STRAIGHT STAIR

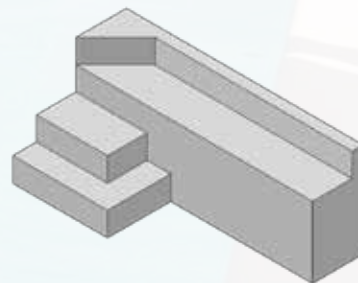
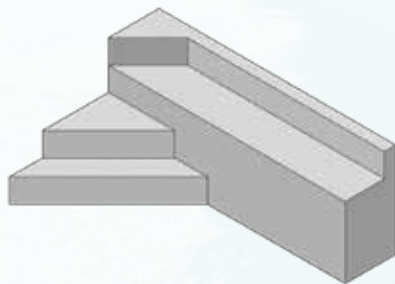

SCALE CON PANCA CON KIT IDROMASSAGGIO
STAIRS WITH SITTING COMPLETE WITH HYDROMASSAGE JETS KIT

**GAMMA SCALE IN ACRILICO
RANGE OF ACRYLIC STAIRS**



Scala Romana



Scala Sofa



Scala Opera

COLORI / COLOURS



Grigio
Grey



Azzurro
Blue



Celeste
Light blue

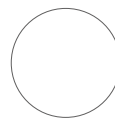

Bianco
White



Sabbia
Sand

SCALA ROMANA / ROMAN STAIR



cod.1030220 -1030290



cod.1030239

Codice/ code	Descrizione/description	Larghezza esterna	Altezza	Numero scalini	Prezzo/price
1030220	Scala Romana azzurra / blue stair	2	1,2	3	1.881,00 €
1030221	Scala Romana bianca / white stair	2	1,2	3	1.881,00 €
1030222	Scala Romana celeste / light blue stair	2	1,2	3	1.881,00 €
1030290	Scala Romana grigio / grey stair	2	1,2	3	1.881,00 €
1030225	Scala Romana azzurra / blue stair	2,5	1,2	4	2.214,00 €
1030226	Scala Romana bianca / white stair	2,5	1,2	4	2.214,00 €
1030227	Scala Romana celeste / light blue stair	2,5	1,2	4	2.214,00 €
1030228	Scala Romana sabbia / sand stair	2,5	1,2	4	2.214,00 €
1030229	Scala Romana grigio / grey stair	2,5	1,2	4	2.214,00 €
1030230	Scala Romana azzurra / blue stair	3	1,2	3	2.659,00 €
1030231	Scala Romana bianca / white stair	3	1,2	3	2.659,00 €
1030232	Scala Romana celeste / light blue stair	3	1,2	3	2.659,00 €
1030233	Scala Romana sabbia / sand stair	3	1,2	3	2.659,00 €
1030234	Scala Romana grigio / grey stair	3	1,2	3	2.659,00 €
1030236	Scala Romana bianca / white stair	3	1,5	4	2.820,00 €
1030237	Scala Romana celeste / light blue stair	3	1,5	4	2.820,00 €
1030238	Scala Romana sabbia / sand stair	3	1,5	4	2.820,00 €
1030239	Scala Romana grigio / grey stair	3	1,5	4	2.820,00 €

SCALA SOFA / SOFA STAIR



cod.1030314

Codice/ code	Descrizione/description	Larghezza esterna	Altezza	Numero scalini	Prezzo/ price
1030311	Scala Sofa azzurra / blue stair	3	1,2	3	2.661,00 €
1030312	Scala Sofa bianca / white stair	3	1,2	3	2.661,00 €
1030313	Scala Sofa celeste / light blue stair	3	1,2	3	2.661,00 €
1030314	Scala Sofa sabbia / sand stair	3	1,2	3	2.661,00 €
1030315	Scala Sofa grigio / grey stair	3	1,2	3	2.661,00 €

SCALA OPERA / OPERA STAIR



cod.1030303

Codice/ code	Descrizione/description	Larghezza esterna	Altezza	Numero scalini	Prezzo/ price
1030301	Scala Opera 150 bianca / white stair	2,5	1,5	4	2.254,00 €
1030302	Scala Opera 150 celeste / light blue stair	2,5	1,5	4	2.254,00 €
1030303	Scala Opera 150 sabbia / sand stair	2,5	1,5	4	2.254,00 €
1030304	Scala Opera 150 grigio / grey stair	2,5	1,5	4	2.254,00 €



SCALA BALNEO BALNEO STAIR



Descrizione	Largh. esterna	Altezza	N° scalini	Codice scala + bocchette	Codice scala + bocchette + kit pompa
Scala Balneo azzurra / blue stair	3	1,2	3	1030316	1030321
Scala Balneo bianca / white stair	3	1,2	3	1030317	1030322
Scala Balneo celeste / light blue stair	3	1,2	3	1030318	1030323
Scala Balneo sabbia / sand stair	3	1,2	3	1030319	1030324
Scala Balneo grigio / grey stair	3	1,2	3	1030320	1030325

- Può accogliere più persone
- Seduta spaziosa e confortevole
- Ugelli rotativi e regolabili
- Fornisce i benefici dell'idroterapia
- Can welcome several persons
- Roomy and comfortable seat
- Rotary and adjustable nozzles
- Enjoy real hydrotherapy



RICAMBI PER SCALE / STAIRS SPARE PARTS

Codice / code	Descrizione / description
1030330	Flangia scale 2,00-2,50 / Flange for stairs 2,00-2,50
1030331	Flangia scale 3,00 / Flange for stairs 3,00
1030332	Flangia scale Rivage / Flange for stairs Rivage
1030333	Flangia orizzontale / Horizontal flange
1030334	Flangia verticale / Vertical flange
1030335	Copri-flangia scale 2,00-2,50* / Flange cover for stairs 2,00-2,50
1030336	Copri-flangia scale 3,00* / Flange cover for stairs 3,00
1030337	Copri-flangia scale Rivage* / Flange cover for stairs Rivage
1030338	Copri-flangia orizzontale* / Horizontal flange cover
1030339	Copri-flangia verticale* / Vertical flange cover
1030340	Guarnizione scale 2,00-2,50 / Gasket for stairs 2,00-2,50
1030341	Guarnizione scale 3,00 / Gasket for stairs 3,00
1030342	Guarnizione scale Rivage / Gasket for stairs Rivage
1030343	Viti scale 2,00 / Screws for stairs 2,00
1030344	Viti scale 3,00 / Screws for stairs 3,00
1030345	Viti scale 2,50 e Rivage / Screws for stairs 2,50 and Rivage

*Disponibili nei colori azzurro, bianco, celeste, sabbia e grigio / *Available in colours blue, white, light blue, sand and grey

SCALE SOTTO LINER / UNDER LINER STAIRS



Scala angolo posa liner - Corner stairs laying of the liner



Scale ad angolo - Corner stairs



Scale con panca - Stairs with sitting



SCALA ROMANA / ROMAN STAIRS



Codice/ code	Descrizione/description	Lunghezza	Altezza [m]	N° scalini
1030250	Scala romana/Roman stair	2,50 m	1,20	3
1030273	Scala romana/Roman stair	3,00 m	1,50	4

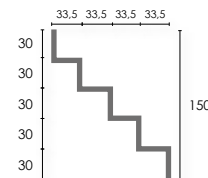
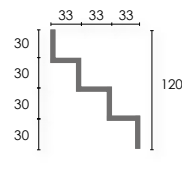

SCALA AD ANGOLO / ANGLED STAIRS



Codice/ code	Descrizione/description	Larghezza interna [m]			Altezza [m]	Numero scalini
		A	B	C		
1030253	Scala ad angolo Angled stair	2,4	1,7	1,7	0,9	3
1030276	Scala ad angolo Angled stair	2,5	1,77	1,77	1,2	4

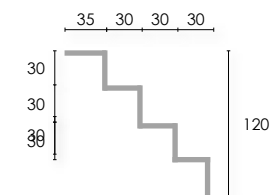
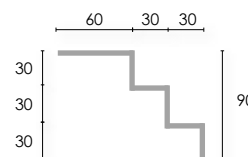
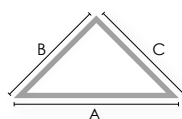

SCALE CON PANCA CON KIT IDROMASSAGGIO
STAIRS WITH SITTING COMPLETE WITH HYDROMASSAGE JETS KIT

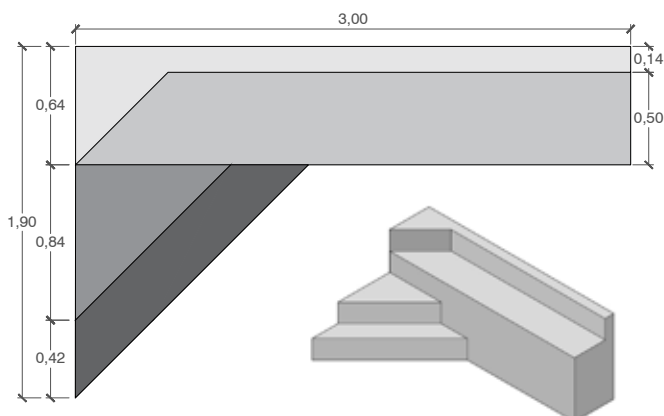

cod.1030410 (N°2 scalini) - cod. 1030413 (N°1 scalino)

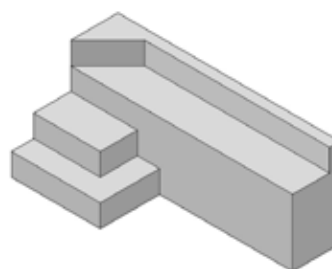
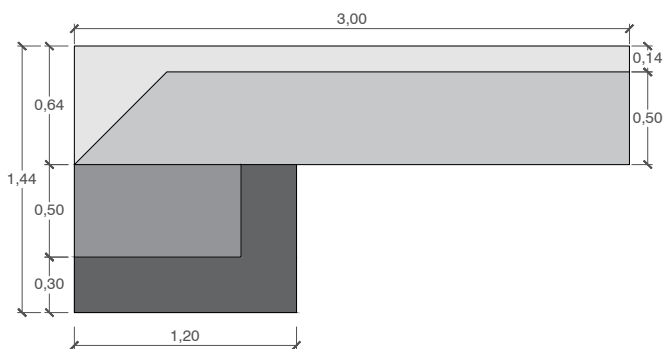

cod.1030412 (N°2 scalini) - cod. 1030415 (N°1 scalino)



Codice/code	Modello	Altezza totale [cm]	N° scalini totale
	ALTEZZA SEDUTA 90 cm- LUNGHEZZA TOTALE 300 cm - sitting height 90 cm - total length 300 cm		
1030410	Scala ad angolo con panca / Corner stair with sitting	120	4
1030412	Scala angolo retto con panca / Square corner stair with sitting	120	4
	ALTEZZA SEDUTA 60 cm- LUNGHEZZA TOTALE 300 cm - sitting height 60 cm - total length 300 cm		
1030413	Scala ad angolo con panca / Corner stair with sitting	90	3
1030415	Scala angolo retto con panca / Square corner stair with sitting	90	3
MODULO ESTENSIONE PANCA - BENCH EXTENSION MODULE			
1030420	Modulo estensione panca - H 60 cm / Bench extension module - H 60 cm	al m	
1030421	Modulo estensione panca - H 90 cm / Bench extension module - H 90 cm	al m	
KIT IDROMASSAGGIO ABBINABILI (MONOFASE) combinable hydromassage kits		kit idro 4 bocchette codice	kit idro 8 bocchette codice
A - Kit bocchette idro e raccorderia A - Hydromassage jets, fittings and pipes		1030417	1030418
B - Kit impianto idromassaggio (blower,quadro,pompa,senza locale tecnico) B - Hydromassage system kit (blower, panel, pump, no technical housing)		1030422	1030423
C - Kit impianto idromassaggio (blower,quadro,pompa con locale tecnico vtr) c - Hydromassage system kit (blower, panel,pump,with technical housing)		1030425	1030426

SCALA AD ANGOLO CON SEDUTA / ANGLED STAIRS WITH SEAT



Codice	Descrizione	Larghezza interna [m]			Altezza [m]	N° scalini
		A	B	C		
1030367	Scala ad angolo con seduta Corner stair with seat	2,4	1,7	1,7	0,9	3
1030368	Scala ad angolo con seduta Corner stair with seat	3	2,12	€ 2,12	1,2	4

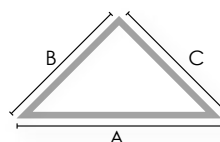

SCALA CIRCOLARE / ROUND STAIRS



Codice	Descrizione	R raggio esterno [mm]	Altezza [m]	Numero scalini
1030272	Scala circolare Round stair	1300	0,9	3
1030257	Scala circolare Round stair	1600	1,2	4

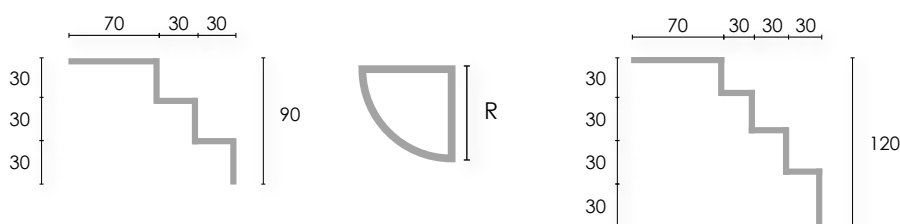

SCALA DRITTA / STRAIGHT STAIRS



Codice	Descrizione	Lunghezza modulare	Altezza [m]	Numero scalini
1030260	Scala dritta Straight stair	1,00 m	0,9	3
1030355	Scala dritta Straight stair	2,00 m	0,9	3
1030356	Scala dritta Straight stair	2,50 m	0,9	3
1030357	Scala dritta Straight stair	3,00 m	0,9	3
1030262	Scala dritta Straight stair	1,00 m	1,2	4
1030358	Scala dritta Straight stair	2,00 m	1,2	4
1030359	Scala dritta Straight stair	2,50 m	1,2	4
1030360	Scala dritta Straight stair	3,00 m	1,2	4

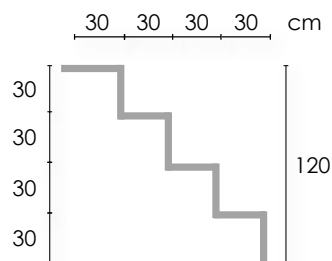
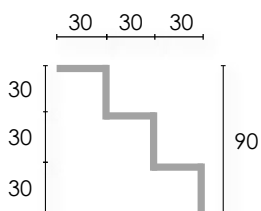

SCALA RELAX / RELAX STAIRS



Codice	Descrizione	Lunghezza	Altezza [m]	Numero scalini
1030270	Scala relax / Relax stair	1,00 m	0,9	3
1030361	Scala relax / Relax stair	2,00 m	0,9	3
1030362	Scala relax / Relax stair	2,50 m	0,9	3
1030363	Scala relax / Relax stair	3,00 m	0,9	3
1030475	Scala relax / Relax stair	1,00 m	1,2	4
1030364	Scala relax / Relax stair	2,00 m	1,2	4
1030365	Scala relax / Relax stair	2,50 m	1,2	4
1030366	Scala relax / Relax stair	3,00 m	1,2	4

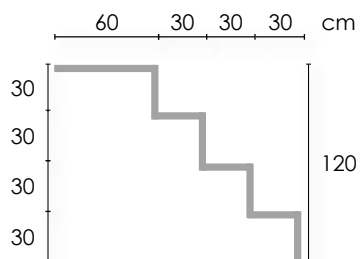
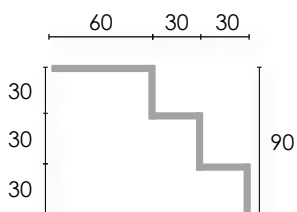

VERNICI IMPERMEABILI E TRASPIRANTI WATERPROOF AND BREATHABLE PAINT

Impermeabile e traspirante, aderisce a tutti i fondi, nuovi e vecchi, verniciati e non. Le sue proprietà sono la totale impermeabilità e resistenza all'acqua, dopo filmazione si distingue per una buona resistenza chimica e ai raggi UV, conservando senza variazioni le sue caratteristiche per un buon periodo di tempo. La posa è pratica e veloce ed il tempo di asciugatura varia da 30 a 60 minuti (si consiglia comunque di attendere almeno 3-4 gg prima di effettuare il riempimento della piscina).

Waterproof and breathable, the paint adheres to all funds, new and old, painted and not. Its properties are the total impermeability and resistance to water, after film formation is distinguished by a good chemical resistance and UV rays, keeping unchanged its characteristics for a good period of time. Installation is quick and convenient and the drying time varies from 30 to 60 minutes (it is advisable to wait at least 3-4 days before filling the pool). Consumption: 0,10-0,15 kg/m².

Diluizioni e resa - con un litro di diluente per vernice <i>Dilutions and yield - with a liter of paint thinner:</i>	
Diluente - Paint thinner	1 : 5
Consumo - Consumption	0,10-0,15 kg/m ²

Codice/ code	Descrizione/description	
1020400	Vernice azzurra per piscina / Light blue paint for pool	Latta / tin 5 l
1020403	Vernice sabbia per piscina / Sand paint for pool	Latta / tin 5 l
1020401	Diluente per vernice / Paint thinner	Latta / tin 1 l
1020402	Diluente per vernice / Paint thinner	Latta / tin 5 l

SILICONE LIQUIDO LIQUID SILICONE

Codice/ code	Descrizione/description
1020440	Silicone liquido impermeabilizzante kg.1 / Waterproof liquid silicone kg.1
1020441	Silicone liquido impermeabilizzante kg.5 / Waterproof liquid silicone kg.5



UN RIVESTIMENTO UNICO

Le membrane di rivestimento sono l'alternativa intelligente alle finiture tradizionali, quali piastrelle o vernice.

La loro lacca esclusiva offre una protezione eccellente contro l'usura quotidiana e il passare del tempo. Sono facili e rapide da installare, si adattano a qualsiasi forma e design e sono facili da mantenere. Il sistema a membrana rinforzata ha molti vantaggi:

- Migliore soluzione tecnica e decorativa per la costruzione di piscine
- Impermeabilità garantita
- Finitura ottimale per nuove piscine e le ristrutturazioni di quelli esistenti
- Veloce e facile installazione
- Si adatta a tutti i tipi di forme e disegni
- Meno costoso di finiture tradizionali

A UNIQUE MEMBRANE

Reinforced membranes are the intelligent alternative to traditional finishes, such as tiles or paint.

Their exclusive lacquer affords outstanding protection against everyday wear and tear and the passage of time. They are easy and quick to install, adapt to any shape and design and are effortless to maintain. The reinforced membrane system has many advantages:

- The best technical and decorative solution for the construction of swimming pools
- Guaranteed watertightness
- The optimum finish for new pools and the renovation of existing ones
- Fast and easy installation
- Adapts to all kinds of shapes and designs
- Less expensive than traditional pool finishes



PERFETTA TENUTA DELL'ACQUA *Watertightness*

Le proprietà esclusive forniscono il più alto livello di sicurezza e protezione per le piscine, oltre a proteggere dal degrado estetico, agenti atmosferici e usura. Facile da installare, semplice da mantenere e adattabile a qualsiasi disegno.

The exclusive properties provide the highest level of security and protection for swimming pools, as well as protecting it from aesthetic deterioration, atmospheric agents and usury. Easy to install, simple to maintain and adaptable to any design.



PROTEZIONE *Protection*

Salvaguarda e protegge la vostra piscina - proprio come la propria pelle. Non solo fornisce la migliore protezione contro i raggi UV, macchie, graffi e biodegradazione, ma resiste contro l'usura quotidiana, e l'uso a lungo termine.

It safeguards and protects your swimming pool - just like your own skin. Not only does it provide the best protection against UV rays, stains, scratches and biodegradation, but endures against everyday wear and tear and long-term use.



RINNOVAMENTO *Renovtion*

Le membrane di rivestimento garantiscono un rivestimento protettivo per la vostra piscina, a prescindere dalla sua forma o dimensione. Viene ampiamente usato nella costruzione e ristrutturazione sia delle piscine pubbliche sia delle private, in quanto può essere installato su tutti i tipi di superfici esistenti, tra cui piastrelle, mosaico, cemento e poliestere.

Lining membranes guarantee a protective liner for your pool, regardless of its form, shape or size. It is widely used in construction, public and private pools restructuring, as it can be installed over all manner of existing surfaces, including tile, mosaic, cement and polyester.





VASTA SCELTA
Selection

Si offre una vastissima gamma di membrane e liner, diversificata in piacevoli soluzioni per l'impermeabilizzazione della piscina. Colori, texture e design innovativi sono stati concepiti per dare alla piscina un look molto contemporaneo.

We offer a wide range of membranes and liners, diversified in pleasant solutions for the waterproofing of the pool. Colours, textures and innovative designs have been conceived to give a very contemporary look to the pool.



**AQUALINER 75/100 E LINER IN PVC TINTA UNITA O STAMPATI
PVC LINER IN SOLID COLOURS OR PRINTED**

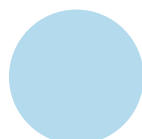

celeste
light blue



sabbia
sand

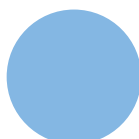

azzurro
blue



bianco
white



grigio
grey



mosaico blu
blue mosaic



mosaico grigio
grey mosaic



marmorizzato
marbled



carrara
carrara



Descrizione /description

Aqualiner 75/100 - piscine rettangolari, tutti i tipi di fondo - al m2 Aqualiner 75/100 - rectangular, all floor contours - per m²

Per altre forme contattateci / For other shapes please contact us

*Specificare in fase di ordine in coda al codice il tipo di aggancio: Hung, Overlap, Harpon

	TINTA UNITA					STAMPATI			
Codice	1050580	1050581	1050582	1050583	1050584	1050970	1050971	1050972	1050973
Colore	celeste	sabbia	azzurro	bianco	grigio	mosaico blu	mosaico grigio	marmorizzato	carrara

**TIPI DI AGGANCIO: HUNG, OVERLAP
LINER LOCKING TRACK: HUNG, OVERLAP**

2 TIPI DI AGGANCIO

Tutti i nostri Aqualiner possono essere consegnati con due tipi di agganci: Aggancio Hung - Aggancio Overlap.
Our Aqualiner can be finished with any of the two types of liner locking track configurations: Hung and Overlap.



Nessuna saldatura visibile, nessuna differenza di colore
No visible weld, no colour difference



Colore o stampato perfettamente omogeneo, rispetto del motivo stampato
Homogenous colour or pattern, pattern respected

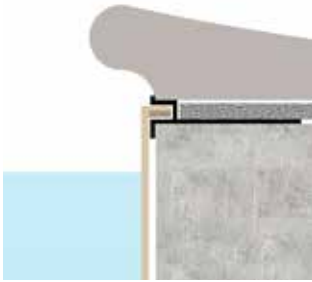

- AGGANCIAMENTO HUNG / HUNG LINER LOCKING TRACK
 - Affidabilità ultrannuale
 - Assenza di saldature visibili sulla periferia superiore del liner, garantendo un'estetica incomparabile
 - Nessuna differenza visibile di colore, tra la membrana e il profilato d'aggancio del liner
 - Un invecchiamento uniforme della membrana
 - Una resistenza totale ai micro-organismi e agli U.V.
 - Un colore perfettamente omogeneo
 - Il rispetto dei disegni in caso di bande o membrana stampata
- *Ultra-annual reliability*
 - *No visible welds around the upper periphery of the liner, guaranteeing an incomparable aesthetic*
 - *No visible colour difference between the liner and the liner locking track*
 - *Uniform ageing of the membrane*
 - *Resistant to attack from micro-organisms and UV radiation*
 - *Perfectly homogenous colour*
 - *The design of patterned liners and tile bands is respected*

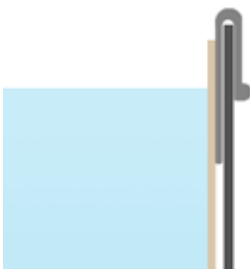

- AGGANCIAMENTO OVERLAP / OVERLAP LINER LOCKING TRACK
 - Questo tipo di aggancio permette di regolare l'altezza del liner al momento della posa sul cantiere. Il liner dev'essere confezionato con un'altezza supplementare di circa 10 cm, permettendo di effettuare questa regolazione. Alcune costruzioni sono equipaggiate di una guida alluminio Overlap. Su semplice richiesta possiamo confezionare dei liner con questo tipo di aggancio, converrà prevedere in questo caso un'altezza del muro superiore di 10 cm del liner finito.
- *With this type of liner locking track, the height of the liner can be adjusted on site. The liner must be an additional 10 cm high to allow for this adjustment. Some constructions are fitted with aluminium Overlap tracks. We can manufacture liners with this type of liner locking track on request, do not forget to add an additional 10 cm to the height of the finished liner..*

PREZZI AQUALINER 75/100 CONFIGURAZIONE STANDARD CLASSICA PRICES AQUALINER 75/100 STANDARD CONFIGURATION CLASSICAL



Tronco di piramide
Wedge base



Fondo piatto h=1,50 m
Flat bottom h=1,50 m

DIMENSIONI		TINTA UNITA	STAMPATI
Modello	Sup m2	Codice	Codice
8,00x3,00 m	63	1050001	1050101
8,00x4,00 m	70	1050002	1050102
9,00x3,00 m	64	1050003	1050103
9,00x4,00 m	78	1050004	1050104
10,00x4,00 m	86	1050005	1050105
10,00x5,00 m	101	1050006	1050106
11,00x5,00 m	110	1050007	1050107
12,00x5,00 m	119	1050008	1050108
12,00x6,00 m	137	1050009	1050109
13,00x6,00 m	147	1050010	1050110
14,00x7,00 m	178	1050011	1050111
15,00x7,00 m	189	1050012	1050112

DIMENSIONI		TINTA UNITA	STAMPATI
Modello	Sup m2	Codice	Codice
8,00x3,00 m	57	1050015	1050115
8,00x4,00 m	68	1050016	1050116
9,00x3,00 m	63	1050017	1050117
9,00x4,00 m	75	1050018	1050118
10,00x4,00 m	82	1050019	1050119
10,00x5,00 m	95	1050020	1050120
11,00x5,00 m	103	1050021	1050121
12,00x5,00 m	111	1050022	1050122
12,00x6,00 m	126	1050023	1050123
13,00x6,00 m	135	1050024	1050124
14,00x7,00 m	171	1050025	1050125
15,00x7,00 m	200	1050026	1050126

FLAGON MEMBRANA DI RIVESTIMENTO PER LAGHETTI / MEMBRANE FOR ARTIFICIAL LAKE

FLAGON CSL membrana di rivestimento per laghetti, colore grigio, spessore 1,5 mm, altezza 2,10 m, rotolo da 20 m.
 FLAGON AT membrana di rivestimento atossica per vasche alimentari (colore bianco) oppure per pesci (colore grigio scuro) spessore 1,5 mm, altezza 2,10 m, rotolo da 20 m.
 CSL Flagon membrane for ponds, color grey, thickness 1.5 mm, height 2.10 m, 20 m roll.
 AT Flagon non-toxic membrane for food reservoir (white) or fish (dark grey) thickness 1.5 mm, height 2.10 m, 20 m roll.

Codice/ code	Descrizione/description
1050560	Flagon CSL grigio / grey
1050561	Flagon AT alimentare bianco / food reservoir (white)
1050562	Flagon AT pesci grigio scuro / fish (dark grey)

SEGNACORSIE / MARK LANES

Codice/ code	Descrizione/description
1050516	Segnacorsie spess 1,5 mm - largh 25 cm - lungh 25 m nero / mark lane thick.1,5mm - width 25 cm - length 25 m dark

GAMMA DELIFOL NG - MEMBRANA IN PVC TINTA UNITA RANGE DELIFOL NG - SOLID COLOR PVC MEMBRANE

CARATTERISTICHE TECNICHE:
 calandrate, plastificate monomericamente (PVC-P) con un rinforzo interno di un tessuto altamente resistente allo strappo. Prodotte in conformità alle norme EN 15836-2 e EN ISO 9001. Le membrane antisdrucchiolo hanno una speciale goffatura a sfera. Prodotte in conformità alle norme EN 13451, EN 15288-1 e EN 16582-1.

- Spessore membrana standard 1,50 mm.
- Spessore membrana antisdrucchiolo 1,80 mm.

TECHNICAL SPECIFICATIONS:
 calendered, monomeric plasticised (PVC-P) with an internal reinforcement of a highly tear-resistant fabric. Manufactured in accordance with the standards EN 15836-2 and EN ISO 9001. The anti-slip membranes have a special spherical embossing. Manufactured in accordance with standards EN 13451, EN 15288-1 and EN 16582-1.

- Standard membrane thickness 1.50 mm.
- Anti-slip membrane thickness 1.80 mm.

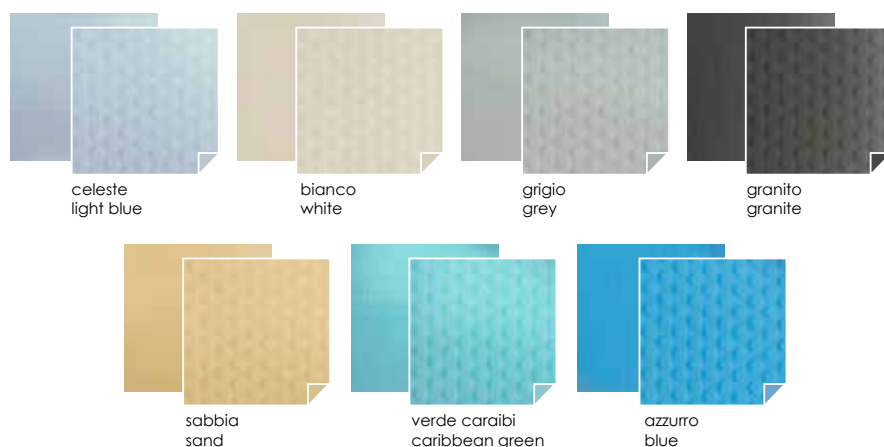

	celeste light blue	bianco white	grigio grey	granito granite	sabbia sand	verde caraibi caribbean green	azzurro blue
	h. 1,65 m	h. 1,65 m	h. 1,65 m	h. 1,65 m	h. 1,65 m	h. 1,65 m	h. 2 m
standard 1,50 mm	1050900	1050901	1050902	1050903	1050904	1050905	1050906 1050907
antisdrucchiolo/ anti-slip 1,80 mm	1050910	1050911	1050912	1050913	1050914	1050915	1050916 -

PVC LIQUIDO PER DELIFOL LIQUID PVC FOR DELIFOL



PVC liquido in barattoli da 1 kg.
 Liquid PCV in 1 kg cans.

celeste light blue	bianco white	grigio grey	granito granite	sabbia sand	verde caraibi caribbean green	azzurro blue
1050920	1050921	1050922	1050923	1050924	1050925	1050926

GAMMA RENOLIT RANGE RENOLIT

RENOLIT ALKORPLAN TOUCH

TOUCH

Telo armato da 2 mm, stampato e con rilievo, dal design ispirato alla natura per conferire carattere e personalità alle piscine. Disponibile in 6 colorazioni.

Reinforced 2 mm sheet, printed and with relief, with a design inspired by nature to give character and personality to the pools. Available in 6 colours.



RENOLIT ALKORPLAN CERAMICS

CERAMICS

Con uno spessore maggiore rispetto a una membrana tradizionale, necessario per ottenere il suo rilievo, stile mosaico è uno dei rivestimenti per piscine più resistenti. Disponibile in 4 colorazioni.

With a greater thickness than a traditional membrane, necessary to obtain its relief, mosaic style is one of the most resistant swimming pool coverings. Available in 4 colours.



RENOLIT ALKORPLAN XTREME

XTREME

La prima membrana armata resistente al cloro. Telo armato unicolor da 1,5 mm, con garanzia estesa su colore, macchie e tenuta. Disponibile in 7 colorazioni.

The first reinforced chlorine-resistant membrane. 1.5 mm unicolor reinforced fabric, with extended guarantee on color, stains and hold. Available in 7 colours.



RENOLIT ALKORPLAN 2000

2000

Telo armato unicolor da 1,5 mm, laccato, con pigmenti di grande resistenza e plastificanti ad alta longevità, destinato a durare nella piscina.

Disponibile in 7 colorazioni.

1.5 mm unicolor reinforced sheet, lacquered, with highly resistant pigments and high longevity plasticizers, destined to last in the pool. Available in 7 colours.



RENOLIT ALKORPLAN NATURAL POOL Bio-piscine

NATURAL POOL

Membrana impermeabilizzante flessibile in polivinilcloruro (PVC-P) con rinforzo in poliestere. Progettato per piscine naturali e piccoli laghi per uso privato.

Disponibile in 3 colorazioni.

Flexible waterproofing membrane in polyvinylchloride (PVC-P) with polyester reinforcement. Designed for natural pools and small lakes for private use. Available in 3 colours.



RENOLIT ALKORPLAN TOUCH

FRISE

Per decorare la piscina con la classe e la qualità della gamma TOUCH. La goffratura classe C conferisce a queste frise la qualità antiscivolo e le dimensioni le rendono particolarmente versatili ed applicabili in ogni punto della vasca.

To decorate the pool with the class and quality of the TOUCH range. The C-class embossing gives these frise the non-slip quality and the dimensions make them particularly versatile and applicable at any point of the pool.



ALKORPLAN T2000 - MEMBRANA IN PVC ARMATO TINTA UNITA / PVC MEMBRANE IN SOLID COLORS

Membrana PVC spessore 1,5 mm idonea per il rivestimento piscine, composta da due strati calandratati in policloruro di vinile flessibile (PVC-P) e rinforzata con una rete di poliestere. Assemblaggio mediante saldatura ad aria calda (termofusione). Vernice acrilica di protezione. Fornita in rotoli da 25 m / antisdrucciolo 25 m spessore 1,8 mm.

PVC membrane thickness 1,5 mm suitable for coating swimming pools, made up of two layers of polyvinyl chloride calendered flexible (PVC-P) and reinforced with a polyester mesh. Assembled by hot air welding (hot melt). Acrylic paint protection. Supplied in rolls of 25 m / non-slip 25 m thickness 1,8 mm.



Design antisdrucciolo
Antislip design

Codice tinta unita h 1,65	Codice tinta unita h 2,05	Descrizione	
1050720	1050728	Alkorplan T2000 celeste chiaro / light blue	
1050721	1050729	Alkorplan T2000 azzurro / blue	
1050722	1050732	Alkorplan T2000 verde Caraibi / green	
1050723	1050772	Alkorplan T2000 bianco / white	
1050724	1050730	Alkorplan T2000 grigio / grey	
1050725	1050733	Alkorplan T2000 grigio scuro / dark grey	
1050727	1050731	Alkorplan T2000 sabbia / sand	



grigio scuro / dark grey



celeste/light blue



azzurro / blue

Codice antisdrucciolo h 1,65 m	Descrizione
1050483	Alkorplant T-2000 antisdrucciolo 25m bianco/white
1050484	Alkorplant T-2000 antisdrucciolo 25m azzurro/blue
1050485	Alkorplant T-2000 antisdrucciolo 25m verde caraibi/green
1050486	Alkorplant T-2000 antisdrucciolo 25m celeste/light blue
1050487	Alkorplant T-2000 antisdrucciolo 25m sabbia/sand
1050488	Alkorplant T-2000 antisdrucciolo 25m grigio/grey
1050489	Alkorplant T-2000 antisdrucciolo 25m grigio scuro/dark grey

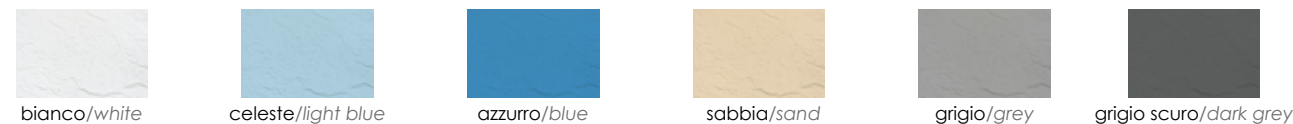

ALKORPLAN 1000 MEMBRANA IN PVC ARMATO TINTA UNITA / PVC MEMBRANE IN SOLID COLORS

Membrana PVC spessore 1,5 mm idonea per il rivestimento piscine, armata internamente con rete di poliestere. Fornita in rotoli da 25 m.

PVC membrane thickness of 1.5 mm suitable for covering swimming pools, armed internally with polyester mesh. Supplied in rolls of 25 m.

Codice tinta unita h 1,65m	Descrizione
1050700	Alkorplan 1000 celeste chiaro / light blue
1050701	Alkorplan 1000 azzurro / blue
1050703	Alkorplan 1000 bianco / white
1050704	Alkorplan 1000 grigio / grey
1050706	Alkorplan 1000 sabbia / sand

ALKORPLAN TOUCH E VOGUE DISPLAY



Codice/code	Descrizione/description	Dimensioni/size
1041315	Display da tavolo	Alkorplan touch 53x31x12
1041316	Display da terra	Alkorplan touch 111x111x11
1041317	Display da tavolo	Alkorplan vogue 53x31x12

ALKORPLAN VOGUE MEMBRANA IN PVC ARMATO STAMPATA / PRINTED PVC MEMBRANE



Le membrane ALKORPLAN VOGUE e TOUCH non solo sono stampate, ma anche goffrate e incise, ottenendo un effetto tridimensionale. Hanno uno spessore di 2 mm, fornite in rotoli da 21 m.

The membranes Alkorplan Vogue and Touch are not only printed but also embossed and incised, obtaining a tridimensional effect. They have a thickness of 2 mm. Supplied in rolls of 21 m.

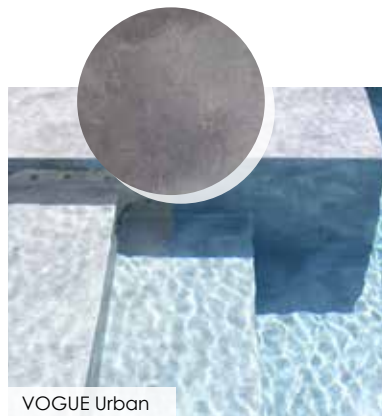

Codice/code	Descrizione/description	Dimensioni/size
1050803	Alkorplan Vogue Vintage	h 165 m
1050805	Alkorplan Vogue Urban	h 165 m
1050806	Alkorplan Vogue Summer	h 165 m

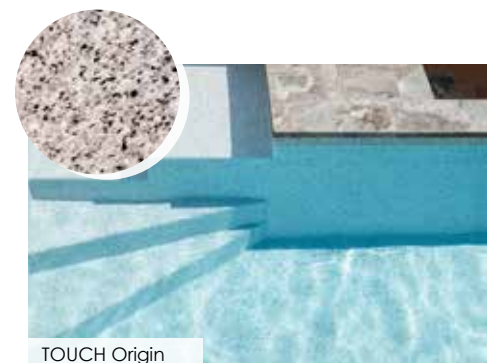

ALKORPLAN TOUCH MEMBRANA IN PVC ARMATO STAMPATA / PRINTED PVC MEMBRANE

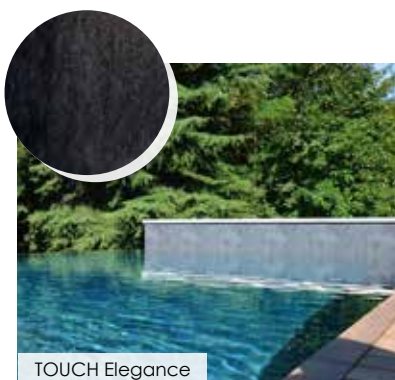



Codice stampato h 1,65	Descrizione/description		
1050757	Alkorplan TOUCH Elegance / Elegance		
1050758	Alkorplan TOUCH Relax / Relax		
1050759	Alkorplan TOUCH Authentic / Authentic		
1050777	Alkorplan TOUCH Vanity / Vanity		
1050778	Alkorplan TOUCH Sublime / Sublime		
1050779	Alkorplan TOUCH Prestige / Prestige		
1050774	Alkorplan TOUCH Origin / Origin		

Codice/code	Descrizione/description
1050870	Fettuccia fissaggio parete TOUCH

FRISE TOUCH

FRISE TOUCH per decorare la piscina con stile unico, con la classe e la qualità della gamma TOUCH. La goffratura classe C conferisce a queste frise la qualità antiscivolo e le dimensioni di 33cmx20m le rendono particolarmente versatili ed applicabili in ogni punto della vasca : bordi, gradini, sfiori o inserti decorativi.

FRISE TOUCH to decorate the pool with a unique style, with the class and quality of the TOUCH range. The C-class embossing gives these frise the non-slip quality and the dimensions of 33cmx20m make them particularly versatile and applicable at any point of the pool: edges, steps, overflows or decorative inserts.



Codice/code	Descrizione/description	Dimensioni	
1050771	Frise TOUCH Prestige / Frise TOUCH Prestige	h33cm x L20m x sp 2 mm	a rotolo/roll
1050773	Frise TOUCH Sublime / Frise TOUCH Sublime	h33cm x L20m x sp 2 mm	a rotolo/roll

ALKORPLAN CERAMICS MEMBRANA IN PVC ARMATO A RILIEVO / IN RELIEF PVC MEMBRANE

Le membrane ALKORPLAN CERAMICS a rilievo, goffrate e armate con rete di poliestere, possiedono l'aspetto estetico del mosaico. Protette con speciale ed esclusiva vernice acrilica multi-strato. Hanno uno spessore di 2 mm, fornite in rotoli da 21 m.

The membranes **Alkorplan Ceramics** in relief, embossed and reinforced with polyester net, have the aesthetic appearance of the mosaic. Protected with special and exclusive acrylic multilayer paint. They have a thickness of 2 mm, supplied in rolls of 21 m.

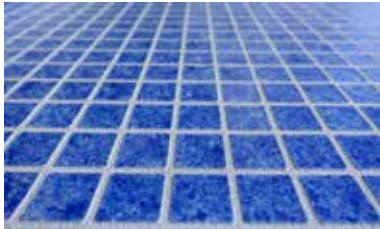

Ceramics Atenea



Ceramics Selene

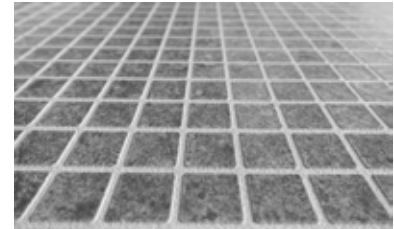

Ceramics Etna

Codice Ceramics h 1,65	Descrizione/description
1050781	Alkorplan CERAMICS Atenea / Atenea
1050782	Alkorplan CERAMICS Selene / Selene
1050783	Alkorplan CERAMICS Etna / Etna

PVC LIQUIDO PER ALKORPLAN / LIQUID PVC FOR ALKORPLAN

Codice/code	Descrizione/description	Barattolo/jar
1050745	Pvc liquido Alkorplan celeste / light blue liquid pvc	0,9 kg
1050746	Pvc liquido Alkorplan azzurro / blue liquid pvc	0,9 kg
1050747	Pvc liquido Alkorplan verde Caraibi / green liquid pvc	0,9 kg
1050748	Pvc liquido Alkorplan bianco / white liquid pvc	0,9 kg
1050749	Pvc liquido Alkorplan grigio / grey liquid pvc	0,9 kg
1050750	Pvc liquido Alkorplan grigio scuro / dark grey liquid pvc	0,9 kg
1050752	Pvc liquido Alkorplan sabbia / sand liquid pvc	0,9 kg
1050753	Pvc liquido Alkorplan trasparente / transparent liquid pvc	0,9 kg
1050851	Pvc liquido Alkorplan elegance / elegance liquid pvc	0,9 kg
1050852	Pvc liquido Alkorplan relax / relax liquid pvc	0,9 kg
1050853	Pvc liquido Alkorplan authentic / authentic liquid pvcg	0,9 kg
1050864	Pvc liquido Alkorplan vanity / vanity liquid pvc	0,9 kg
1050865	Pvc liquido Alkorplan sublime / sublime liquid pvc	0,9 kg
1050866	Pvc liquido Alkorplan prestige / prestige liquid pvc	0,9 kg
1050878	Pvc liquido Alkorplan origin / origin liquid pvc	0,9 kg
1050744	Pvc liquido Alkorplan Ceramics bianco / ceramics white liquid pvc	0,9 kg
1050807	Pvc liquido Alkorplan Vogue Vintage	0,9 kg
1050808	Pvc liquido Alkorplan Vogue Urban	0,9 kg
1050809	Pvc liquido Alkorplan Vogue Summer	0,9 kg
1050534	Flacone + tappo per l'applicazione del PVC liquido / Bottle + cap for the application of liquid PVC	

RIVESTIMENTO XTREME / MEMBRANE XTREME

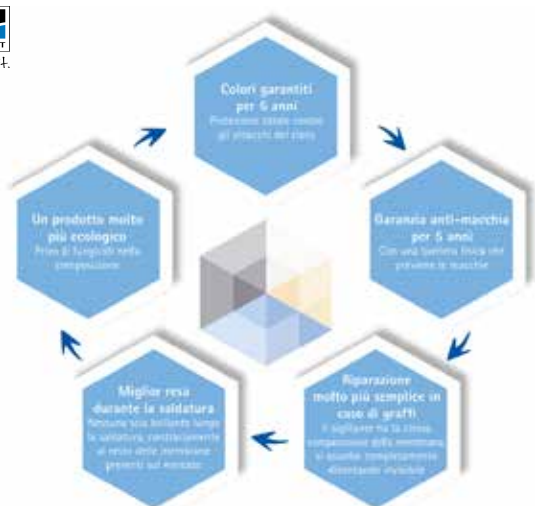

Membrana PVC spessore 1,5 mm idonea per il rivestimento piscine, calandrata in cloruro di vinile flessibile (PVC-P) e rinforzata con una rete di poliestere. Protetta da una innovativa ed esclusiva formulazione altamente resistente al cloro e ai raggi UV. Fornita in rotoli da 25 m / antisdrucciolo 10 m spessore 1,8 mm.

PVC membrane thickness 1,5 mm suitable for coating swimming pools, calendered in polyvinyl chloride flexible (PVC-P) and reinforced with a polyester mesh. Protected by an innovative and exclusive formulation highly resistant to chlorine and UV rays. Supplied in rolls of 25 m / non-slip 10 m thickness 1,8 mm.



Codice tinta unita h1,65 h 1,65	Codice antisdrucciolo h1,65	Descrizione
1050874	1050875	Alkorplan Xtreme ice / ice
1050788	1050794	Alkorplan Xtreme sahara / sahara
1050789	1050795	Alkorplan Xtreme celeste / blue fresh
1050790	1050796	Alkorplan Xtreme azzurro / azure
1050791	1050797	Alkorplan Xtreme silver / silver
1050792	1050798	Alkorplan Xtreme volcano / volcano
1050793	1050799	Alkorplan Xtreme onyx / onyx

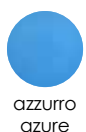

XTREME ANTISDRUCCILOLO / ANTISLIP XTREME

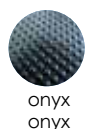

PVC LIQUIDO ALKORPLAN XTREME / XTREME SAHARA LIQUID PVC

Codice/ code	Descrizione/description	Barattolo/can
1050876	Pvc liquido Alkorplan Xtreme ice / Xtreme ice liquid pvc	barattolo 0,9 kg
1050856	Pvc liquido Alkorplan Xtreme sahara / Xtreme sahara liquid pvc	barattolo 0,9 kg
1050857	Pvc liquido Alkorplan Xtreme celeste / Xtreme light blue liquid pvc	barattolo 0,9 kg
1050858	Pvc liquido Alkorplan Xtreme azzurro / Xtreme blue liquid pvc	barattolo 0,9 kg
1050859	Pvc liquido Alkorplan Xtreme silver / Xtreme silver liquid pvc	barattolo 0,9 kg
1050862	Pvc liquido Alkorplan Xtreme volcano / Xtreme volcano liquid pvc	barattolo 0,9 kg
1050863	Pvc liquido Alkorplan Xtreme onyx / Xtreme onyx liquid pvc	barattolo 0,9 kg



ALKORPLAN BIO-PISCINE NATURAL SWIMMING POND ALKORPLAN

Membrana impermeabile in PVC-P rinforzata in poliestere, spessore 1,5 mm, appositamente creata per le bio-piscine e i laghetti ad uso privato. Il rivestimento Alkorplan BIO-PISCINE rispetta e non danneggia pesci e piante. Fornita in rotoli da 20 m.

CARATTERISTICHE TECNICHE:

- atossico per pesci e piante acquatiche
- resistente alla rottura e al rigonfiamento
- alta resistenza alla perforazione
- resistenza alla penetrazione delle radici
- saldabile facilmente ad aria calda



Waterproofing membranes of flexible polyvinyl chloride (PVC-P) with a polyester reinforcing, 1,5 mm thick. Designed for natural swimming. RENOLIT ALKORPLAN natural swimming pool liner is fish and plant friendly. Supplied in rolls of 20 m

TECHNICAL FEATURES:

- pools and small swimming ponds for private use
- non-toxic for fish and aquatic plants
- resistant to swelling and rotting
- high resistance to puncturing
- root resistance
- very easy to weld with hot air

COLORI DISPONIBILI / AVAILABLE COLOURS



Verde Oliva
Olive Green



Grigio Scuro
Dark Grey

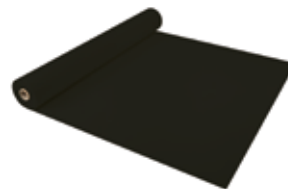

Nero
Black

il COLORE NERO
permette un
riscaldamento più veloce
dell'acqua.

The black colour makes
the water warm up faster



Codice/ code	Descrizione/description	
1050871	Alkorplan BIO PISCINE - grigio scuro / dark grey	€/ m2
1050872	Alkorplan BIO PISCINE - verde oliva / olive green	€/ m2
1050873	Alkorplan BIO PISCINE - nero / black	€/ m2





ALKORPLAN LINEA IDRAULICA HYDRAULIC LINE

Alkorplan 35052 manto sintetico in PVC-P omogeneo atossico non resistente ai raggi UV. Idoneo alla realizzazione di vasche, bacini per accumulo di acqua potabile. Colore grigio chiaro, spessore 1,5 mm, altezza 2,15 m, rotolo da 15 metri.

Synthetic membrane in PVC-P homogeneous non-toxic, not UV resistant. Suitable for the construction of basins for the accumulation of drinking water. Color light grey, thickness 1.5 mm, height 2.15 m, 15 meters rolls.

Alkorplan 35254 manto sintetico in PVC-P omogeneo resistente ai raggi UV. Idoneo alla realizzazione di canali, bacini, lagunaggi, laghetti ornamentali. Colore grigio zinco, spessore 1,5 mm, altezza 2,15 m, rotolo da 20 metri.

Synthetic membrane in PVC-P homogeneous, UV resistant. Suitable for the construction of canals, lagoons, ornamental lakes. Color zinc grey, thickness 1.5 mm, height 2.15 m, 20 meters rolls.

Codice/ code	Descrizione/description	
1050860	Alkorplan 35052 grigio chiaro / light grey	€/ m2
1050861	Alkorplan 35254 grigio zinco / zinc grey	€/ m2

PRODOTTI PER ALKORPLAN / PRODUCTS FOR ALKORPLAN

Alkorplus Sanitized: Prodotto ideale per prevenire la proliferazione di microorganismi e funghi nell'area tra la parete della piscina e la membrana Alkorplan. *The ideal product to prevent the proliferation of microorganisms and fungi in the area between the pool wall and membrane Alkorplan.*

Alkorplus anti-macchia: Prodotto minerale, concentrato al 30%, neutralizza diversi ioni metallici tra i quali rame, piombo, cadmio, argento, riduce la presenza di metalli dissolti nell'acqua della piscina che potrebbero causare macchie o scolorimento della membrana. *Mineral product, concentrated to 30%, neutralizes various metal ions including copper, lead, cadmium, silver, reduces the presence of dissolved metals in pool water that could cause staining or discoloration of*

the membrane. **Alkorclean sgrassante:** Prodotto per la periodica pulizia dei depositi di grasso e sporco sulla linea d'acqua.

Produced for the periodic cleaning of grease and dirt deposits on the water line.

Lamiera plastificata: Lamiera in acciaio zincato da 0,63 mm rivestita con una membrana Alkorplan da 0,8 mm. Per fissare la membrana Alkorplan alle pareti della piscina. *Galvanized steel sheet, 0.63 mm coated with a membrane of 0.8 mm Alkorplan. To attach the membrane to the walls of the pool.* **Striscia di collegamento:** consente la saldatura testa a testa delle membrane Touch tramite accostamento di due estremità di queste. *Backing strip that allows the welding head to head of membranes TOUCH joining the two hems of them.* **Alkorplus**

tessuto non tessuto: in polipropilene azzurro chiaro trattato con additivi antibatterici naturali a base di ioni metallici, per una costante azione antibatterica. Peso 400 gr/m *Fleece membrane in polypropylene light blue treated with natural antibacterial additives based on metal ions. Weight 400 gr/m2*

Alkorfix: sigillante adesivo a base di silano modificato, sviluppato appositamente per impermeabilizzare e rifinire la saldatura tra il bordo perimetrale e la membrana in PVC. Consente ugualmente di eseguire piccole riparazioni temporanee sott'acqua. *Modified silane-based adhesive sealant, specially developed for waterproofing and finish the weld between the perimeter edge and the PVC membrane. It also allows to make small temporary repairs under water.*



cod.1050435

Codice/ code	Descrizione/description	
1050760	Solvente THF - barattolo da 1 l / Solvent jar 1 l	
1050762	Alkorplus Sanitized - flacone da 1 l / Jar 1 l	
1050763	Alkorplus antimacchia - flacone da 1 l / Stain jar 1 l	
1050775	Alkorclean sgrassante - flacone da 1 l / Degreasing jar 1 l	
1050776	Lamiera plastificata colore azzurro spess. mm.1,4 - largh. m 1,00 -lungh. m 2,00 / Plastic-coated sheet metal	al pz
1050764	Lastra PVC colore azzurro spess. mm.2 - largh. m 1,30 - lungh. m 1,50 / Blue PVC sheet	al pz
1050435	Profilo angolare colore azzurro a 90° spess. mm.2 - largh. cm 5x5 - lungh. m 2,00 / Blue 90° angle profile	al pz
1050765	Segnacorsie spess. mm1,5 - largh. cm 25 - lungh. m 25 nero / Mark lanes	al m
1050854	Striscia collegamento saldatura Alkorplan Touch spess.1,5mm - largh. cm 15 - rotolo m.20 / Backing strip	al rotolo
1050880	Alkorfix grigio scuro 300 ml / Alkorfix dark grey 300 ml	
1050881	Alkorfix sabbia 300 ml / Alkorfix sand 300 ml	
1050882	Alkorfix bianco 300 ml / Alkorfix white 300 ml	
1050884	Alkorfix grigio chiaro 300 ml / Alkorfix light grey 300 ml	

ALKORPLUS 81006

Tessuto non tessuto di polipropilene con trattamento anti-microorganismi. *Non-woven polypropylene fabric with anti-microbe treatment.*

Codice/ code	Descrizione/description	
1050428	Materassino di protezione Alkorplus 1,50 x 50 m	al rotolo
1050429	Materassino di protezione Alkorplus 2,00 x 50 m	al rotolo

GAMMA ELBTAL RANGE ELBTAL



ELBTAL 150/100

Il rivestimento Elbtal, prodotto tedesco, è una membrana in PVC plastificato (PVC-P) rinforzato con fibra, spessore 1,5 mm. È disponibile in tinta unita e stampato. Disponibile in 8 colorazioni.

The Elbtal coating, a German product, is a plasticized PVC membrane (PVC-P) reinforced with fiber, 1,5 mm thick. It is available in plain colours and printed. Available in 8 colours.



ROYAL

è una membrana armata impermeabilizzante e antiscivolo (PVC-P) di spessore 2 mm. La lussuosa ottica marmorea in 3D si unisce ad un'eccellente finitura superficiale. Disponibile in 3 colorazioni.

Elbtal Royal is a 2mm thick reinforced waterproofing and anti-slip membrane (PVC-P). The luxurious 3D marble optic combines with an excellent surface finish. Available in 3 colours.



ELITE

La membrana rinforzata ha una protezione superficiale molto speciale, che impedisce la penetrazione di creme solari, cosmetici e cloro. Disponibile in 5 colorazioni.

The reinforced membrane has a very special surface protection, which prevents the penetration of sun cream, cosmetics and chlorine. Available in 5 colours



ISLAND DREAMS

È una membrana in PVC rinforzato con fibra di spessore 2 mm. La goffatura della membrana crea una texture che ricorda le spiagge sabbiose più famose: Fiji, Aruba, Santorini e Maui. Disponibile in 4 colorazioni.

It's a PVC membrane reinforced with 2 mm thick fiber. The embossing of the membrane creates a texture reminiscent of the most famous sandy beaches: Fiji, Aruba, Santorini and Maui. Available in 4 colours.



PEARL

PEARL è una membrana rinforzata con rivestimento perlescente con una protezione superficiale speciale e di alta qualità contro le macchie e lo scolorimento. Disponibile in 4 colori.

PEARL is a pearlescent coated reinforced swimming pool membrane with a high-quality and special surface protection against stains and discoloration. Available in 4 colours.



ELBTAL 150/100 - MEMBRANA IN PVC ARMATO TINTA UNITA, SPESSORE 1,50 MM
ELBTAL 150/100 - SOLID COLOR OR PRINTED PVC MEMBRANE 1,5 MM

CARATTERISTICHE TECNICHE: resistente ai raggi UV, resistente al freddo ed agli agenti atmosferici, buona saldabilità, privo di metalli pesanti e fisiologici ineccepibili secondo la norma EN 71 / 3, resistente a tutti i prodotti chimici usuali per il trattamento dell'acqua nelle piscine, disponibile anche nella versione antisdrucciolo nello spessore di 2,00 mm.

The coating Elbtal, German product, is a plasticized membrane in PVC (PVC-P) reinforced with fiber. It's available in plain and printed. SPECIFICATIONS: UV-resistant, cold resistant and weatherproof, good weldability, free of heavy and physiological metals unobjectionable according to EN 71/3, resistant to all usual chemicals for water treatment in swimming pools, also available in slip thickness of 2.00 mm.



Codice tinta unita h1,65x25m	Codice antisdrucciolo h1,65x10m	Codice tinta unita h2,00x25m	Descrizione
1050605	1050615	1050610	Elbtal celeste chiaro / light blue
1050606	1050616	1050611	Elbtal azzurro / blue
1050607	1050617	1050612	Elbtal bianco / white
1050627	1050628	-	Elbtal grigio / grey
1050609	1050619	-	Elbtal verde Caraibi / green
1050608	1050618	1050613	Elbtal sabbia / sand
1050629	1050645	-	Elbtal nero / black
1050646	1050604	-	Elbtal grigio antracite / dark grey

ELBTAL ROYAL - SUPERFICIE 3D
ELBTAL ROYAL - 3D SURFACE



CARATTERISTICHE TECNICHE: elevata resistenza all'invecchiamento, resistente ai raggi UV, all'acqua clorata, alghe e microrganismi, al freddo ed agli agenti atmosferici. Buona saldabilità, privo di metalli pesanti e fisiologici ineccepibili secondo la norma EN 71/3. Royal può essere utilizzata anche come membrana antisdrucciolo con livello di protezione B. Da utilizzarsi con PVC liquido nel colore bianco (1050622).

The coating Elbtal Royal is a reinforced waterproofing and anti-slip membrane (PVC-P) 2 mm thick. The luxurious 3D marble optics is combined with an excellent surface finish. TECHNICAL FEATURES: high resistance to aging, UV-resistant, chlorinated water, algae and microorganisms, to cold and atmospheric agents. Good weldability, free of heavy and physiological metals unobjectionable according to EN 71/3. Royal can also be used as an anti-slip membrane serving the anti-slip protection level B.

To be used with liquid PVC in colour white (1050622).

Codice h 1,65	Membrana Rotolo spessore 2 mm x larghezza 1,65m x lunghezza 20m - 33 m ² Roll thickness 2 mm x width 1,65m x length 20m - 33 m ²	Prezzo al m ² h1,65
1050681	Elbtal ROYAL - Victoria / Victoria	53,40 €
1050682	Elbtal ROYAL - Elisabeth / Elisabeth	53,40 €



Victoria



Elisabeth

ELBTAL ELITE - MEMBRANA DI RIVESTIMENTO RINFORZATA ELBTAL ELITE - REINFORCED MEMBRANE



CARATTERISTICHE TECNICHE:

Resistente contro le Creme Solari: test dimostrano una resistenza alle macchie del 300% rispetto ad un telo standard. Resistente alle macchie linea di galleggiamento: la membrana rinforzata impedisce la penetrazione di creme solari, cosmetici e altre sostanze chimiche che scoloriscono la membrana o ne causano le macchie, in particolare sulla linea di galleggiamento sotto l'effetto delle radiazioni UV, permettendo un mantenimento della pulizia della piscina più semplice.

Resistente ai raggi UV. Resistente alle sostanze chimiche come il cloro, una delle cause di scolorimento dei teli.

The reinforced membrane Elbtal Elite has a special acrylic surface coating, that is produced without phthalate, making it the healthiest swimming pool membrane on the market.

SPECIFICATION:

Stain Resistance: the reinforced membrane prevents the penetration of sun cream, cosmetics and other chemicals, e.g. chlorine, that discolor the membrane or cause stains, especially on the waterline under the effect of UV radiation. That makes Elite easy to clean. UV Radiation Resistance.

Chlorine Discoloration: typically occurring over time. The durable elite membrane strongly resists chemical substances such as chlorine.

RESISTENTE*
ALLE MACCHIE
5 ANNI
garanzia

RESISTENTE*
AL CLORO
5 ANNI
garanzia

* Vedere la nostra garanzia e le guide sul trattamento dell'acqua

* See our warranty and water treatment guides.



COLORI DISPONIBILI/AVAILABLE COLOURS



Bianco ghiaccio
Arctic White



Sabbia
Sand Beach



Azzurro
Blue Sky



Blu
Deep Sea



Grigio Chiaro
Grey Rock



Codice h1,65	Membrana Rotolo spessore 1,5 mm x larghezza 1,65m x lunghezza 25m - 41,25 m2 Roll thickness 1,5 mm x width 1,65m x length 25m - 41,25 m2
1050664	Elbtal ELITE - Bianco ghiaccio / Arctic White
1050665	Elbtal ELITE - Sabbia / Sand Beach
1050666	Elbtal ELITE - Azzurro / Blue Sky
1050667	Elbtal ELITE - Blu / Deep Sea
1050668	Elbtal ELITE - Grigio chiaro / Grey Rock

Codice antisdrucchiolo h1,65	Antisdrucchiolo Rotolo spessore 1,5 mm x larghezza 1,65m x lunghezza 10m - 16,50 m2 Roll thickness 1,5 mm x width 1,65m x length 10m - 16,50 m2
1050669	Elbtal ELITE - Bianco ghiaccio / Arctic White
1050670	Elbtal ELITE - Sabbia / Sand Beach
1050671	Elbtal ELITE - Azzurro / Blue Sky
1050672	Elbtal ELITE - Blu / Deep Sea
1050673	Elbtal ELITE - Grigio chiaro / Grey Rock

Codice/code	PVC Liquido - Barattolo da/Can 0,9 l
1050674	Elbtal ELITE - Bianco ghiaccio / Arctic White
1050675	Elbtal ELITE - Sabbia / Sand Beach
1050676	Elbtal ELITE - Azzurro / Blue Sky
1050677	Elbtal ELITE - Blu / Deep Sea
1050678	Elbtal ELITE - Grigio chiaro / Grey Rock

ELBTAL ISLAND DREAMS - MEMBRANA DI RIVESTIMENTO RINFORZATA
ELBTAL ISLAND DREAMS - REINFORCED MEMBRANE



Resistente ai raggi UV, resistente al freddo ed agli agenti atmosferici, buona saldabilità, privo di metalli pesanti e fisiologici ineccepibili secondo la norma EN 71/3, resistente ai prodotti chimici usuali per il trattamento dell'acqua nelle piscine. Island Dreams può essere utilizzata anche come membrana antiscivolo con livello di protezione C. Si adatta perfettamente e può essere combinato alle membrane standard così come al PVC liquido nei colori nero (1050626), grigio (1050625), sabbia (1050623) e bianco (1050622).

The coating Elbtal island dreams, is a PVC membrane reinforced with 2 mm thick fiber. By embossing the structure the texture recalls the most famous sandy beaches : Fiji, Aruba, Santorini and Maui. TECHNICAL FEATURES: UV-resistant, cold and weather resistant, good weldability, free of heavy and physiological metals unobjectionable according to EN 71/3, resistant to all usual chemicals for water treatment in swimming pools. Island Dreams can also be used as an anti-slip membrane serving the anti-slip protection level C. It fits perfectly and can be combined with standard membranes as well as with liquid PVC in colours black (1050626), grey (1050625), sand (1050623) and white (1050622).

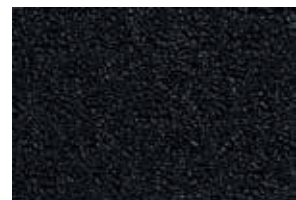

Island dreams Fiji
cod. 1050847

Island dreams Aruba
cod. 1050848

Island dreams Santorini
cod. 1050849

Island dreams Maui
cod. 1050877

Codice/ code	Membrana Rotolo spessore 2 mm x larghezza 1,60 m x lunghezza 20m - 32m2 Roll thickness 2 mm x width 1,60 m x length 20 m - 32 m2
1050847	Elbtal ISLAND DREAMS - Fiji
1050848	Elbtal ISLAND DREAMS - Aruba
1050849	Elbtal ISLAND DREAMS - Santorini
1050877	Elbtal ISLAND DREAMS - Maui



ELBTAL PEARL160/100 - MEMBRANA IN PVC ARMATO STAMPATA PRINTED AND LAQUERED PVC PEARL

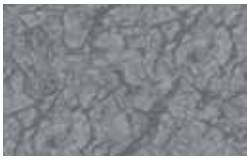

nero perla
pearl black

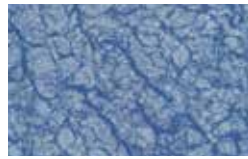

blu perla
pearl blu



bianco perla
pearl white



blu Lagoon
blue Lagoon



Codice/code stampato h1,65x25m	Descrizione/description Rotolo spessore 2 mm x larghezza 1,60 m x lunghezza 20m - 32m2 Roll thickness 2 mm x width 1,60 m x length 20 m - 32 m2 MEMBRANA STAMPATA E LACCATA EFFETTO MADREPERLA / PEARL EFFECT
1050823	Elbtal nero perla / pearl black
1050824	Elbtal blu perla / pearl blue
1050825	Elbtal bianco perla / pearl white
1050832	Elbtal silver Lagoon / silver Lagoon

PVC LIQUIDO PER ELBTAL / LIQUID PVC FOR ELBTAL

Codice/ code	Descrizione/description	Barattolo / Can
1050620	Pvc liquido Elbtal celeste / light blue liquid pvc	barattolo 1 kg
1050621	Pvc liquido Elbtal azzurro / blue liquid pvc	barattolo 1 kg
1050622	Pvc liquido Elbtal bianco / white liquid pvc	barattolo 1 kg
1050625	Pvc liquido Elbtal grigio / grey liquid pvc	barattolo 1 kg
1050624	Pvc liquido Elbtal verde Caraibi / green liquid pvc	barattolo 1 kg
1050623	Pvc liquido Elbtal sabbia / sand liquid pvc	barattolo 1 kg
1050626	Pvc liquido Elbtal nero / black liquid pvc	barattolo 1 kg
1050650	Pvc liquido Elbtal grigio antracite / dark grey liquid pvc	barattolo 1 kg
1050651	Pvc liquido Elbtal trasparente / trasparent liquid pvc	barattolo 1 kg
1050534	Flacone + tappo per l'applicazione del PVC liquido / bottle + cap for the application of liquid PVC	

ELBTAL WBT - MEMBRANA DI RIVESTIMENTO PER LAGHETTI ELBTAL WBT - MEMBRANE FOR ARTIFICIAL LAKE



ELBTAL WBT membrana di rivestimento per laghetti, corsi d'acqua artificiali, adatto per pesci.
Colore nero, spessore 1,00 mm, altezza 2,00 m, rotolo da 20 metri.

ELBTAL WBT membrane for ponds, artificial streams, suitable for fishes.
Colour black, thickness 1.0 mm, height 2.00 m, 20 meter roll.

Codice/ code	Descrizione/description
1050841	ELBTAL WBT nero/ black

ULTIMATE BORDER

Codice / code	Descrizione /description	Dimensioni/dimensions	
1050329	Ultimate border BLU SURF / Ultimate border BLUE SURF	h25cm x L27,5m x sp 1,2mm	a rotolo/roll
1050330	Ultimate border MOSAICO BLU / Ultimate border MOSAIC BLUE	h26cm x L25m x sp 1,2mm	a rotolo/roll
1050331	Ultimate border MOSAICO TERRACOTTA / MOSAIC terracotta	h26cm x L25m x sp 1,2mm	a rotolo/roll
1050332	Ultimate border BIANCO / WHITE	h26cm x L25m x sp 1,2mm	a rotolo/roll
1050333	Ultimate border SABBIA / SAND	h26cm x L25m x sp 1,2mm	a rotolo/roll
1050334	Ultimate border AZZURRO / LIGHT BLUE	h26cm x L25m x sp 1,2mm	a rotolo/roll
1050335	Ultimate border GRIGIO CHIARO / LIGHT GREY	h26cm x L25m x sp 1,2mm	a rotolo/roll
1050336	Ultimate border nastro per montaggio / mounting Tape	h50cm x L100m	a rotolo/roll



cod. 1050333

cod. 1050330

cod. 1050334

cod. 1050331



cod. 1050335



cod. 1050332



cod. 1050336

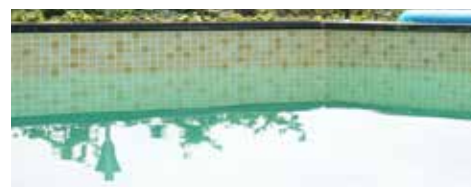

LINERLOCK PROFILO DI RIFINITURA / LINER FINISHING PROFILE LINERLOCK

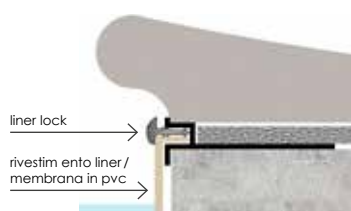
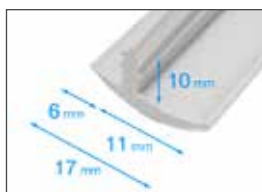

liner lock

rivestim ento liner /
membrana in pvc



bianco
white



grigio
grey



grigio scuro
dark grey



sabbia
sand



celeste
light blue



azzurro
blue



nero
black

Codice / code	Descrizione /description	
1050410	LINERLOCK profilo di rifinitura liner bianco/ Linerlock profile of finishing liner white	al rotolo da 50m/roll 50 m
1050470	LINERLOCK profilo di rifinitura liner celeste/ Linerlock profile of finishing liner light blue	al rotolo da 50m/roll 50 m
1050471	LINERLOCK profilo di rifinitura liner azzurro/ Linerlock profile of finishing liner blue	al rotolo da 50m/roll 50 m
1050473	LINERLOCK profilo di rifinitura liner sabbia/ Linerlock profile of finishing liner sand	al rotolo da 50m/roll 50 m
1050474	LINERLOCK profilo di rifinitura liner grigio/ Linerlock profile of finishing liner grey	al rotolo da 50m/roll 50 m
1050475	LINERLOCK profilo di rifinitura liner grigio antracite/ Linerlock profile of finishing liner dark grey	al rotolo da 50m/roll 50 m
1050476	LINERLOCK profilo di rifinitura liner nero/ Linerlock profile of finishing liner black	al rotolo da 50m/roll 50 m

GUIDA DI AGGANCIAMENTO PER LA POSA DEL LINER COUPLING GUIDE TO FIX LINER



cod. 1050402



cod. 1050403



cod. 1050399

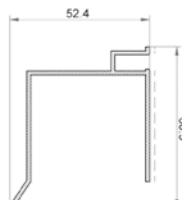

cod. 1050396



cod. 1050412



cod. 1050414

Codice /code	Descrizione /description
1050412	Guida alluminio 43 mm diritta, barre da 3 m / straight aluminum guide 43 mm, bars 3 m
1050413	Guida alluminio 43 mm forma libera, barre da 3 m / free-shape aluminum guide 43 mm, bars 3m
1050402	Guida alluminio 100 mm diritta, barre da 3 m / straight aluminum guide 100 mm, bars 3 m
1050403	Guida alluminio 100 mm forma libera, barre da 3 m / free-shape aluminum guide 100 mm, bars 3 m
1050399	Guida alluminio 100 mm diritta con aletta, barre da 3 m / straight aluminum guide 100 mm with fin bars 3
1050398	Guida alluminio 100 mm forma libera con aletta, barre da 3 m / free-shape aluminum guide 100 mm with fin, bars 3 m
1050396	Guida alluminio diritta U, barre da 3 m / U straight aluminum guide, bars 3 m
1050397	Guida alluminio forma libera U, barre da 3 m / U free-shape aluminum guide, bars 3 m
1050414	Guida sottobordo in alluminio per Safety Cover / Aluminum underboard guide for Safety Cover



cod. 1050404



cod. 1050422



cod. 1050405



cod. 1065211



cod. 1050423

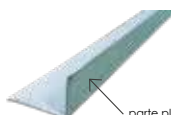

cod. 1050424

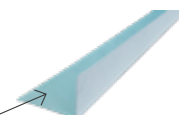

cod. 1050432



cod. 1050407



cod. 1050540

Codice /code	Descrizione /description	Dimensione /dimensions
1050404	Guida PVC, sotto il bordo / pvc guide, under edge	32x8 mm - barre/bars 2,50 m
1050422	Guida PVC bianca diritta / white straight pvc guide	50 mm -barre/bars 2,00 m
1050405	Guida PVC a L per sfioro / L pvc guide, for overflow	25x25 mm - barre/bars 2,50 m
1065211	Profilo per supporto griglia in PVC / support grid in pvc	25x35 mm - barre/bars 2,50 m
1050423	Guida alluminio piattina plastificata per parete / flat aluminum plasticized guide	30 mm - barre/bars 2,00 m
1050424	Guida alluminio piattina a L plastificata esternamente per parete / flat aluminum plasticized internalguide	30x20 mm - barre/bars 2,00 m
1050432	Guida alluminio piattina a L plastificata internamente per parete / flat aluminum plasticized internalguide	30x20 mm - barre/bars 2,00 m
1050433	Guida in PVC posa-telo colore azzurro / blue sheet-laying pvc guide	50 mm - sp. 2 mm -barre/bars 1,50 m
1050407	Tasselli fissaggio rapido zincato 6/40 / galvanized quick fixing anchors 6/40- box with 200 pieces	scatola/box 200 pz
1050409	Tasselli fissaggio rapido inox 6/40 / inox quick fixing anchors 6/40- box 200 pieces	scatola/box 200 pz
1050540	Bordino pvc bianco a saldare - rotolo 50 m / pvc white border to be welded - roll 50 m	9x3 mm - al m /per meter

PRODOTTI PER IL LINER PRODUCTS FOR LINER

BIOTEX

Materassino di protezione in tessuto non tessuto.

Protective mattress non-woven fabric.

ALKORPLUS 81006

Tessuto non tessuto di polipropilene con trattamento anti-microrganismi.

Non-woven polypropylene fabric with anti-microbe treatment.

APC system

Sistema brevettato protegge l'intervallo critico esistente tra gli angoli di una piscina dallo sviluppo e dalla proliferazione dei micro-organismi. Fabbricato a partire da fibre compresse, l'APC system riceve un trattamento biocida preventivo.

Patented system protects the critical range between the angles of a swimming pool by the development and proliferation of micro-organisms. Made from compressed fibers, the APC system receives a biocide treatment.



Codice/ code	Descrizione/description
1050416	Rotolo materassino protezione 1,20x30 m Roll protective mattress
1050417	Rotolo materassino protezione 1,60x30 m Roll protective mattress
1050418	Rotolo materassino protezione 2,00x30 m Roll protective mattress



Codice/ code	Descrizione/description		
1050428	Rotolo materassino di protezione Alkorplus Roll protective mattress	1,50x50 m	al rotolo
1050429	Rotolo materassino di protezione Alkorplus Roll protective mattress	2,00x50 m	al rotolo

Codice/ code	Descrizione/description
1050420	"APC system" angolo in feltro, trattato biocida lotto da 18 lunghezze da 2 m Corner in felt, biocide treatment, lot of 18 lengths from 2 m



Codice/ code	Descrizione/description
	COLLA "BIOCOL" ANTI-BATTERI PER FELTRI / ANTI-BACTERIA GLUE "BIOCOL" FOR FELT
1050421	Barattolo da 5 kg di colla Biocol / ar of 5 kg of glue Bioco

MATERASSINO PE ESPANSO MONVISO CON ADESIVO FOAM PE MATTRESS MONVISO WITH ADHESIVE

Polietilene espanso reticolato a cella chiusa tipo TR 35 kg/m³, spessore 5 mm, colore bianco.

Adesivo supporto film PE. Rotolo da 30 m h x 1,50 m.

Cross-linked foam polyethylene with closed cell TR 35 kg/m³, thickness 5 mm, colour white.

PE film adhesive support. Roll of 30 mxh1.50 m.



Codice / code	Descrizione /description
1050430	Rotolo Monviso, materassino polietilene espanso con adesivo film PE h 1,50 x 30 m / Roll Monviso, foam PE with adhesive PE film h1,50x30 mal rotolo

ASPIRATORE Q-VAC III PER LA POSA DEL LINER Q-VAC III ASPIRATOR TO FIX LINER



Silenzioso, sistema di raffreddamento del motore, attacco aspirazione di 10 cm, manico per il trasporto.

Silent cooling system of the engine, aspiration connect of 10 cm, carrying handle.

Codice/code	Descrizione/description
1050431	Aspiratore Liner Q-VAC III / Liner aspirator

CHIODI AD ESPANSIONE / EXPANSION BOLTS



Codice/code	Descrizione/description	Scatola/ box
1050539	Chiodi ad espansione mm.15 / Bolts 15 mm, box 100 pieces	100 pz
1050570	Chiodi ad espansione mm.25 / Bolts 25 mm, box 100 pieces	100 pz

SOLVENTE E COLLA / SOLVENT AND GLUE



Codice/code	Descrizione/description	Confezione/ package
1050535	Solvente THF / Solvent THF	3 L
1050534	Flacone + tappo per l'applicazione del PVC liquido Bottle + cap for the application of liquid PVC	
1050767	Colla per membrana ALKORGLUE Glue for membrane ALKORGLUE	5 L
1050761	Colla a contatto per membrana ALKORGLUE, idonea all'esecuzione dei dettagli Contact glue for membrane ALKORGLUE, suitable for the execution of the details	5 L
1050770	Colla a contatto per membrana ALKORGLUE, idonea all'esecuzione dei dettagli Contact glue for membrane ALKORGLUE, suitable for the execution of the details	20 L
1050578	Colla per la membrana FLEXOCOL V Glue for membrane FLEXOCOL V	5 kg

MESSICANI / MEXICANS



Codice/ code	Descrizione/description
1050521	Messicani anti-rigurgito in PVC 80 mm / Mexican anti regurgitation in pvc 80 mm
1050522	Messicani anti-rigurgito in PVC 100 mm / Mexican anti regurgitation in pvc 100 mm

PROTECT LINER



Agente microbiodica molto potente: riduce la proliferazione dei microrganismi sotto i rivestimenti. Da applicare preventivamente sui muri della piscina, prima della posa del liner o della membrana PVC, polverizzandolo. 5 l di Protect liner permettono di trattare circa 100 m².

Powerful microbiocidal agent: it reduces the growth of microorganisms in the coatings. Applied in advance on the walls of the pool, before laying the liner or PVC membrane, pulverizing. 5 l of Protect Liner treat about 100 square meters.

Codice/code	Descrizione/description	Confezione/package
1050451	Protect Liner	5 L

LEISTER

LEISTER TRIAC ST é un apparecchio per saldare ad aria calda, indispensabile per la posa dei rivestimenti. Di grande aiuto nei lavori idraulici, per centinare un tubo PVC o riparare un incollaggio difettoso.

Leister Triac ST is a hot air welding equipment, essential for the laying of membranes. It helps you in plumbing for PVC pipe or repair a defective bonding.



cod. 1050630



cod. 1050642



cod. 1050684



cod. 1050686



cod. 1050633



cod. 1050648



cod. 1050691



cod. 1050649



cod. 1050653



cod. 1050654

Codice/ code	Descrizione/description
1050630	LEISTER TRIAC ST 230V-1600 W per ugello ad innesto LEISTER TRIAC ST 230V-1600 W for plug-in nozzle
1050642	LEISTER TRIAC AT 230V-1600 W c/indicazione digitale della temperatura per ugello ad innesto LEISTER TRIAC AT 230V-1600 W c/digital temperature display for plug nozzle
1050684	Uniroof 300, 230V/3450W, 30 mm, EU PLUG
1050686	Hot Jet S 230V/460W con spina Euro
1050633	Rullo di pressione 22D - 40 mm Pressure roller 22D - 40 mm
1050648	Rullo di pressione 21 Pressure roller 21
1050691	Uncino per prove di saldatura Hook for welding tests
1050649	Leister cutter con 2 diverse forme di lama Leister cutter with two different blade shapes
1050653	Lama uncinata per cutter Leister - scatola da 10 lame Hooked blade for Leister cutter - box with 10 blades
1050654	Lama diritta per cutter Leister Straight-edge blade for Leister cutter

LEISTER

LEISTER TRIAC AT è dotato di display con indicazione digitale della temperatura. La sonda termina a monte della resistenza garantendo temperature regolate in modo preciso. Possibilità di regolare la portata d'aria in modo indipendente. Massima pulizia e protezione.

Leister Triac AT is equipped with digital display of the temperature. The sensor ends upstream of the resistance, that guarantees adjusted temperatures in a precise way. Possibility to adjust the air flow independently. Maximum cleaning and protection.



cod. 1050634



cod. 1050635



cod. 1050637



cod. 1050647



cod. 1050687



cod. 1050688



cod. 1050689



cod. 1050690



cod. 1050685



cod. 1050692



cod. 1050693

Codice /code	Descrizione /description
1050634	Ugello 30 A3- 20 mm curvato 60 Curved nozzle
1050635	Ugello 30 A1- 20 mm Nozzle
1050637	Ugello saldatura rapida 30B8 - 12 mm Speed welding nozzle
1050647	Ugello 31 A - 5 mm tondo applicabile a innesto Round push-fit nozzle
1050687	Ugello a fessura larga 20 mm, inseribile Wide slot nozzle 20 mm, insertable
1050688	Ugello a fessura larga 20 mm, con angolo Wide slot nozzle 20 mm with angle
1050689	Ugello a tubo ø 5mm inseribile a innesto Tubular nozzle
1050690	Ugello di saldatura rapida per nastro da 8mm su ugello a tubo Speed welding nozzle
1050693	Premitelo "Kehlfix" per angolo interno
1050685	Prolunga cavo pur 3x2,5 mm ² L=15m Extension cable
1050692	Forbici universali 260 mm Utility scissors

**PAVIMENTI ESTERNI E BORDI PISCINE
OUTDOOR FLOORS AND POOL EDGES**



I bordi e le piastrelle per la piscina donano eleganza e un tocco di personalità. Raffinata ed accurata nei dettagli, la pavimentazione riproduce in modo realistico le caratteristiche della pietra naturale con un aspetto pulito ed unico, evitando di scaldarsi col sole e gelare con il freddo.

The edges and tiles for the pool lend elegance and a touch of personality to the pool. Flooring refined and accurate in detail, realistically representing the characteristics of natural stone with a clean and unique, avoiding heat up with the sun and freeze in the cold.

BORDO PISCINA ROSALIND ANTISCIVOLO / ROSALIND POOL EDGE ANTI-SLIP



Bordo in agglomerato cemento graniglia 50 x 31 x spessore 3 cm
Agglomerated concrete edge pool 50 x 31 x thickness 3 cm

DISPONIBILE IN / AVAILABLE IN



sabbia/sand

Codice/ code	Descrizione/description
1020540	Bordo Rosalind sezione diritta 50 x 31 / Straight section 50 x 31
1020541	Bordo Rosalind sezione angolo retto / 90° section
1020542	Bordo Rosalind sezione angolo interno rovescio / Internal reverse angle
1020543	Bordo Rosalind sezione angolo interno scala Romana / Internal angle Roman ladder
1020722	Bordo Rosalind sezione a raggio / Radius section
1020737	Bordo Rosalind sezione a raggio rovescio / Radius reverse section
1020517	Kit bordo Rosalind scala Romana 2,00 m / Kit with Roman ladder 2,00 m
1020513	Kit bordo Rosalind scala Romana 2,50 m / Kit with Roman ladder 2,50 m
1020515	Kit bordo Rosalind scala Romana 3,00 m / Kit with Roman ladder 3,00 m
1020524	Kit bordo Rosalind scala in opera raggio 1,50 m / Kit ladder 1,50 m radius

Bordo Rosalind SABBIA disponibile nei seguenti RAGGI: / Rosalind sand radius section

Codice	1020722	1020723	1020724	1020725	1020726	1020727	1020728	1020729	1020730	1020731	1020733
Raggio	0,75	1,00	1,40	1,50	1,75	2,00	2,50	3,00	3,50	4,00	8,00

Bordo Rosalind SABBIA disponibile nei seguenti RAGGI A ROVESCIO: / Rosalind sand radius section

Codice	1020737	1020738	1020739
Raggio [m]	2,00	3,00	3,50



BORDO PISCINA LISCIO / SMOOTH POOL EDGE



Bordo in agglomerato cemento graniglia 60x31,5 cm, spessore 3,0 cm.
Smooth agglomerated concrete grit 60x31,5 cm, thickness 3,0 cm.

Raccomandato trattamento antiscivolo



bianco liscio / smooth white edge



grigio liscio / smooth grey edge

Codice bianco/code white	Codice grigio/code grey	Descrizione/description
1020001	1020870	Bordo liscio sezione diritta 60x31,5 cm / Smooth streigh section 60x31,5 cm
1020002	1020871	Bordo liscio sezione angolo retto / Smooth 90° section
1020004	1020872	Bordo liscio sezione angolo interno rovescio / Smooth internal angle reverse
1020854	1020873	Bordo liscio angolo dx interno scala romana raggio 1m Smooth internal right angle roman ladder - r1 m
1020855	1020874	Bordo liscio angolo sx interno scala romana raggio 1m Smooth internal left angle roman ladder - r1 m
1020856	1020875	Bordo liscio angolo dx interno sc. romana raggio 1,5m Smooth internal right angle roman ladder -r1,5m
1020857	1020876	Bordo liscio angolo sx interno scala romana raggio 1,5m Smooth internal left angle roman ladder - r1,5m
1020750	1020880	Bordo liscio sezione a raggio / Smooth radius section
1020767	1020896	Bordo liscio sezione a raggio rovescio / Smooth reverse radius section
1020501	1020877	Kit bordo liscio scala Romana 2,00 m / Kit for Roman ladder 2,00 m
1020502	1020878	Kit bordo liscio scala Romana 2,50 m / Kit for Roman ladder 2,50 m
1020504	1020879	Kit bordo liscio scala Romana 3,00 m / Kit for Roman ladder 3,00 m
1020518	1020904	Kit bordo liscio scala in opera raggio 1,50 m / Kit ladder 1,50 m radius

Bordo BIANCO LISCIO disponibile nei seguenti RAGGI: / White smooth radius section

Codice	1020750	1020751	1020752	1020753	1020754	1020755	1020756	1020757	1020758	1020759	1020760	1020761	1020763	1020764	1020765	1020766
Raggio [m]	0,65	0,80	1,00	1,25	1,40	1,50	1,75	2,00	2,50	3,00	3,50	4,00	5,00	6,25	7,00	8,50

Bordo BIANCO LISCIO disponibile nei seguenti RAGGI A ROVESCIO: / White smooth reverse radius section:

Codice	1020767	1020768	1020769	1020770	1020771	1020772	1020773	1020774
Raggio [m]	1,25	1,50	2,00	3,00	3,50	4,00	5,50	6,50

Bordo GRIGIO LISCIO disponibile nei seguenti RAGGI: / Grey smooth radius section

Codice	1020880	1020881	1020882	1020883	1020884	1020885	1020886	1020887	1020888	1020889	1020890	1020891	1020892	1020893	1020894	1020895
Raggio [m]	0,65	0,80	1,00	1,25	1,40	1,50	1,75	2,00	2,50	3,00	3,50	4,00	5,00	6,25	7,00	8,50

Bordo GRIGIO LISCIO disponibile nei seguenti RAGGI A ROVESCIO: / Grey smooth reverse radius section:

Codice	1020896	1020897	1020898	1020899	1020900	1020901	1020902	1020903
Raggio [m]	1,25	1,50	2,00	3,00	3,50	4,00	5,50	6,50

TRATTAMENTO ANTISCIVOLO / ANTI-SLIP TREATMENT



Trattamento antiscivolo, risolve il problema della scivolosità causata dall'acqua. Non altera l'aspetto estetico della superficie trattata, non forma pellicole superficiali, agisce direttamente sul materiale creando una microporosità tale da consentire l'antiscivolo necessario in presenza d'acqua. Resa : 5 lt per 24 mtl. di superficie.

Anti-slip treatment, solves the problem of sliding caused by water. Does not alter the aesthetics of the treated surface, does not form a surface film, acts directly on the material by creating a microporosity to allow for the necessary anti-slip in the presence of water. Consumption: 5 litres for 24 mtl. of surface.

Codice/code	Descrizione/description
9010036	Prodotto antiscivolo 5 lt - non-slip product

BORDO PISCINA ESPACE TRADIZIONALE / ESPACE STANDARD POOL EDGE

Conforme a UNI EN 1345-1/1 per resistenza allo scivolamento



Espace dritto 50 x 33 cm
Straight section 50 x 33 cm



Angolo retto
90° section



Angolo esterno 90°
External angle 90°



Angolo est. scala
romana 90°
External angle 90°



Sezione a raggio
Radius section

Codice sabbia	Descrizione	Misure [cm]	
BORDO TRADIZIONALE ESPACE spessore 2,7 cm / STANDARD ESPACE EDGE thickness 2,7 cm			
1020070	Bordo Espace dritto / Straight section	50 x 33	al pz.
1020072	Bordo Espace angolo retto / 90° section	38 x 38	al pz.
1020074	Bordo Espace a raggio 1,50 m / Radius section 1,50 m	34,8 est. x 28,5 int	al pz.
1020078	Bordo Espace angolo retto esterno 90° / External angle 90°	33 x 33	al pz.
1020092	Bordo Espace angolo esterno destro r 1,50 / External right angle r 1,50	33 x 28,5	al pz.
1020093	Bordo Espace angolo esterno sinistro r 1,50 / External left angle r 1,50	33 x 28,5	al pz.
1021361	Kit bordo Espace scala Romana raggio 1,50 / Edges kit for Roman stair radius 1,50	-	kit

BORDO PISCINA ESPACE PIATTO / ESPACE FLAT POOL EDGE

Conforme a UNI EN 1345-1/1 per resistenza allo scivolamento



Espace dritto piatto 50x33 cm
Straight section 50x33 cm

DISPONIBILE IN / AVAILABLE IN



sabbia / sand grigio / grey bianco / white

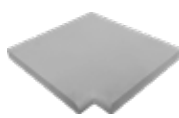

Angolo retto 90° dritto e rovescio
90° section

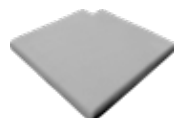

Sezione a raggio
Radius section

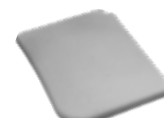

Angolo esterno scala romana dx
External right angle

Codice sabbia	Codice grigio	Codice bianco	Descrizione	Misure [cm]
BORDO PIATTO ESPACE spessore 3,4 cm / ESPACE FLAT EDGE thickness 3,4 cm				
1020089	1020130	1020094	Bordo Espace diritto piatto / Straight flat section	50 x 33
1020097	1020131	1020106	Bordo Espace piatto angolo retto / 90° section	33 x 33
1020102	1020138	1020107	Bordo Espace piatto angolo retto esterno 90° / External angle 90°	33 x 33
1020116	1020133	1020122	Bordo Espace piatto raggio 1,20 m / Radius section 1,20 m	46,9 est. x 36,7 int
1020600	1020134	1020601	Bordo Espace piatto raggio 1,50 m / Radius section 1,50 m	34,8 est. x 28,5 int
1020095	1020135	1020108	Bordo Espace piatto raggio 2,50 m / Radius section 2,50	43,4 est. x 38,3 int
1020183	1020187	1020191	Bordo Espace piatto ang.esterno destro r1,50 / External right ang r1,50	33 x 28,5
1020184	1020188	1020192	Bordo Espace piatto ang.esterno sinistro r1,50 / External left ang r 1,50	33 x 28,5
1020508	1020510	1020193	Kit bordo Espace piatto scala Romana raggio 1,50 Edges kit for Roman stair radius 1,50	

PIASTRELLE E BORDO ESPACE / ESPACE TILES AND EDGE



Sabbiato in agglomerato da esterno, antiscivolo
Rough agglomerated for outdoor, antislip

Conforme a UNI EN 1345-1/1 per resistenza allo scivolamento

DISPONIBILI IN / AVAILABLE IN



sabbia
sand



aquitaine
no bordo tradizionale
aquitaine
no standard edge



grigio
no bordo tradizionale
grey
no standard edge

PIASTRELLE / TILES



BORDI PISCINA / POOL EDGE



bordo tradizionale / standard edge



bordo piatto / flat edge

Codice sabbia	Codice grigio	Codice aquitaine	Descrizione	Misure [cm]
PIASTRELLE ESPACE spessore 2,5 cm / ESPACE TILES thickness 2,5 cm				
1020666	1020668	1020672	Piastrella Espace / Espace tiles	50 x 50 a m2
1020663	1020665	1020679	Piastrella Espace / Espace tiles	50 x 50 a bancale 9 m2

PIASTRELLE E BORDO CASTELLANE / CASTELLANE TILES AND EDGE



In agglomerato da esterno e superficie irregolare
 PIASTRELLE CASTELLANE: spessore 2,5 cm
 BORDO CASTELLANE: spessore 3,3 cm
 Agglomerated for outdoor, irregular surface
 Castellane tiles: thickness 2,5cm
 Castellane edge: thickness 3,3 cm

DISPONIBILE IN / AVAILABLE IN



sabbia / sand



grigio / grey



Codice sabbia	Codice grigio	Descrizione	Misure [cm]	
1020849	1020699	Piastrella Castellane Opus Castellane files	42x28 - 42x42 - 42x56	a bancale 8,5 mq
1020660	1020662	Piastrella Castellane Opus	42x28 - 42x42 - 42x56	a m2
1020160	1020393	Bordo/scalino Castellane sezione dritta 49x33 cm Edge/step straight section 49x33 cm		a pz.
1020161	1020394	Bordo Castellane sezione angolo retto 49x49 cm / 90° section 49x49 cm		a pz.
1020162	1020395	Bordo Castellane sezione a raggio 1,50 m / Radius section 1,50 m		a pz.
1020164	1020397	Bordo Castellane sezione angolo esterno 90° / External angle 90°		a pz.



Scalino sezione dritta 49x33 cm
Straight section 49x33 cm



Angolo retto 90° section



Sezione a raggio 1,50 m
Radius sections 1,50 m



Angolo esterno 90°
External angle 90°



PRODOTTI COMPLEMENTARI / COMPLEMENTARY PRODUCTS

MALTA IMPERMEABILIZZANTE / WATERPROOF MORTAR

Malta impermeabilizzante idrofuga di giuntura disponibile nei colori bianco (per piastrelle colore sabbia), beige (per piastrelle colore aquitaine) e grigio (per piastrelle colore grigio). Preparazione : 5 litri d'acqua per sacco da 25 kg, mescolare fino ad ottenere una pasta omogenea.

Joint waterproofing mortar available in white (for sand tiles), beige (for aquitaine tiles) and grey (for gey tiles) colours. Preparation: 5 liters of water per 25 kg bag, mix until obtaining a homogeneous paste.

MALTA ADESIVA / ADHESIVE MORTAR

Malta adesiva idrofuga per l'incollaggio di pavimentazioni disponibile nel colore beige. Preparazione: da 5,75 a 6,25 litri d'acqua per sacco da 25 kg, impastare usando un miscelatore elettrico (bassa velocità).

Adhesive waterproof mortar for bonding of pavings available in beige colour. Preparation: from 5.75 to 6.25 liters of water per 25 kg bag, knead using an electric mixer (low speed).

STUCCO COLORFILL / COLORFILL PLASTER

Fugante cementizio professionale per la stuccatura di pavimenti e rivestimenti ceramici, vetrosi ed in pietra naturale da 2 a 12 mm.

Consumo in funzione delle dimensioni del giunto. Disponibile nei colori bianco, nero, grigio, ghiaccio, avorio, crema, beige, sabbia, testa di moro, marrone, rosso, arancio, rosa antico, rosso scuro.

Altri colori su richiesta.

Professional cementitious joint sealing for grouting floors and ceramic coatings, vitreous and made of natural stone from 2 to 12 mm. Consumption in function of the size of the joint. Available in white, black, grey, ice, ivory, cream, beige, sand, brown, red, orange, pink, dark red. Other colours on request.

EP LASTIK

Malta elastica bicomponente per l'impermeabilizzazione e la protezione del cemento prima della posa di piastrelle e mosaici in piscina.

Si usa in due mani interponendo una armatura in rete di vetro da 160 gr/m2. Adatto al trattamento delle superfici interne di piscine prima della successiva posa del rivestimento ceramico o vetroso. Consumo impermeabilizzante: 1,7-1,8 kg/m2 per 1 mm di spessore. Per ottenere una impermeabilizzazione con tenuta di colonna d'acqua pari a 1 m è necessario uno spessore minimo di 2 mm.

Two-component elastic mortar for waterproofing and protecting cement before laying tiles and mosaics in the pool. It is used in two coats interposing a 160 gr/m2 glass mesh reinforcement. Suitable for the treatment of the internal surfaces of swimming pools before the subsequent laying of the ceramic or glass coating. Waterproofing consumption: 1.7-1.8 kg/m2 per 1 mm of thickness. A minimum thickness of 2 mm is required to achieve waterproofing with a water column of 1 m.

RASACOLL

Rasante monocomponente in polvere per la rasatura finale di pannelli isolanti in polistirene. Il prodotto va armato con la rete in fibra di vetro. Idoneo all'utilizzo con strutture EPS. Consumo : 1,5 kg/m² per un mm di spessore.

Monocomponent powder smoothing for the final smoothing insulating panels, made of polystyrene. The product is reinforced with fiber glass mesh. Adapt with EPS structures. Consumption: 1,5 kg/m² per 1 mm thickness.

RETE IN FIBRA DI VETRO / REINFORCEMENT FIBER MESH

100% in fibra di vetro per le sue caratteristiche è raccomandata per l'applicazione dell'EP LASTIK. Consigliata per il rinforzo della membrana in strutture esistenti in cls. Larghezza maglia 4,5x5 mm - Grammatura 160 g/m²

100% in fiberglass for its characteristics is recommended for the application of EP LASTIK. Recommended for the reinforcement of membrane of existing concrete structures pools. Width 4,5x5 mm - weight 160 g/m²

BANDELLA RL80S / STRIP RL80S

Bandella sigillante autoadesiva, composta da uno strato viscoelastico e rivestito da tessuto non tessuto.

Self-adhesive sealant strip, composed of a viscoelastic layer and coated by non-woven fabric.

Codice/ code	Modello/model	Colore/color
1020327	Malta impermeabile sacco da 25 kg / Waterproof mortar 25 kg bag	bianco white
1020319	Malta impermeabile sacco da 25 kg / Waterproof mortar 25 kg bag	grigio grey
1020337	Malta impermeabile sacco da 25 kg / Waterproof mortar 25 kg bag	beige beige
1020310	Malta adesiva sacco da 25 kg / Adhesive mortar 25 kg bag	beige beige
1020322	Stucco Colorfill - sacco da 5 Kg / Plaster- bag 5 kg	avorio ivory
1020318	Stucco Colorfill - sacco da 5 Kg / Plaster- bag 5 kg	grigio scuro dark grey
1020317	Impermeabilizzante EP LASTIK - sacco 25 kg e tanica 7,5 l Waterproofing EP LASTIK - bag 25 kg, tank 7,5l	
1020406	Rasante RASACOLL - sacco da 25 kg / RASACOLL - bag 25 kg	
1020417	Rete in fibra di vetro - rotolo da 50 m ² (h1 x 50 m) Reinforcement fiber mesh - roll of 50 m ² - (h1x50m)	
1020418	Bandella sigillante adesiva RL80S - rotolo 10m - scatola da 8 pz Adhesive sealant strip RL80S roll of 10 m box 8 pieces	



cod. 1020327



cod. 1020317

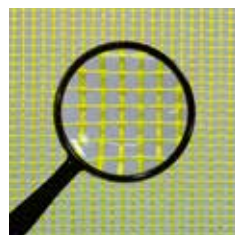

cod. 1020417



cod. 1020418

PULIZIA NORDECAL FORTE / CLEANING STRONG NORDECAL

Disincrostante acido per pietra non lucida, contiene acido cloridrico, leggere attentamente scheda tecnica prima dell'utilizzo.
Consumo medio: 0,2-0,3 litro per m²

Acid descaling for matt stone, contains hydrochloric acid, read carefully technical sheet before using.
Consumption: 0,2-0,3 liter for m²

DETERGENTE DEGERANTE SGRASSANTE / DETERGENT STRIPPER DEGREASER

Diluito in acqua (1:10-1:20), pulisce e sgrassa pavimenti molto sporchi in gres porcellanato, ceramica, pietra naturale, cotto e cemento. Puro, smacchia il gres porcellanato dalle macchie impossibili. È eccellente per il lavaggio di base su pietre non resistenti agli acidi. Ideale per il lavaggio di base del cemento. Deckerante per cere all'acqua, metallizzate e rilucidabili. Elimina il residuo di pretrattamento di gres porcellanato levigato lucido.

Diluted: cleans and removes grease from dirty porcelain stoneware, ceramic, natural stone, brick and concrete. Pure, it removes stains from porcelain stoneware. It is excellent for the basic cleaning of rocks that are not acid resistant. Ideal for basic cleaning of the cement. Wax remover for water based, metal or polishing wax. Eliminates the residual pretreatment of honed polished porcelain stoneware.

**PROTETTIVO PRE-POSA CONTRO LA RISALITA DI SALI E ALTRI AGENTI INQUINANTI
PROTECTIVE PRE-APPLICATION AGAINST THE ASCENT OF SALTS AND OTHER POLLUTANTS**

Protettivo pronto all'uso anti risalita da applicare sul retro di piastrelle o lastre di materiali assorbenti destinate alla posa. Impedisce la risalita di inquinanti dal substrato verso la superficie del materiale (sali, tannino, sostanze ferrose, etc.) evitando la formazione di aloni e/o macchie. Protettivo da applicare prima della posa. Prodotto specifico per pietre naturali, granito, marmo, agglomerati, cotto e materiali assorbenti.

Protective ready to use anti rise to be applied on the back of tiles or slabs of absorbent materials intended for installation. Prevents the rise of pollutants from the substrate to the surface of the material (salts, tannin, ferrous substances, etc.) avoiding the formation of halos and/or stains. Protective product to be applied before laying. Specific product for natural stones, granite, marble, agglomerates, terracotta and absorbent materials.

IDROREPELLENTE TRASPIRANTE / REPELLENT BREATHABLE

Idrorepellente ad effetto naturale pronto all'uso. Impregna il materiale in profondità, conservandone la traspirabilità. Ostacola la crescita di alghe, muffe e licheni. Difende dal degrado causato dagli agenti atmosferici.

Repellent to natural effect. Soak the material in depth, preserving the breathability. It hampers the growth of algae, moss and lichen. It defends from degradation caused by atmospheric agents.

Diluizioni e resa - con un litro di prodotto/acqua:
Dilutions and yield - with a liter:

Manutenzione - maintenance	1:20	200 m ²
Manutenzione - maintenance	1:5	20 m ²
Lav. iniziale pietre - Initial cleaning stones	1:5	30 m ²

Diluizioni e resa - con un litro di prodotto:
Dilutions and yield - with a liter:

	10/15 m ²
--	----------------------

Diluizioni e resa - con un litro di prodotto:
Dilutions and yield - with a liter:

Cotto, mattoni faccia a vista, klinker, pietra, intonaco Tiled, facing bricks, clinker, stone, plaster	10-20 m ²
Cemento - cement	8-10 m ²

Codice/ code	Descrizione/description
1020325	Pulizia Nordecad 5 l / Nordecad cleaning 5 l
1020332	Detergente decerante sgrassante 1 l / Detergent stripper degreaser 1 l
1020335	Detergente decerante sgrassante 5 l / Detergent stripper degreaser 5 l
1020333	Protettivo pre-posa 5 l / Protective pre-application 5 l
1020334	Idrorepellente traspirante 1 l / Repellent breathable 1 l
1020336	Idrorepellente traspirante 5 l / Repellent breathable 5 l



cod. 1020332/1020335



cod. 1020333



cod. 1020334/1020336



Alkorplan TOUCH

MEMBRANA IN PVC ARMATO STAMPATA / PRINTED PVC MEMBRANE



TOUCH Relax



TOUCH Authentic



TOUCH Vanity



TOUCH Sublime



TOUCH Prestige



TOUCH Elegance

Le membrane ALKORPLAN TOUCH non solo sono stampate, ma anche gofrate e incise, ottenendo un effetto tridimensionale. Hanno uno spessore di 2 mm, fornite in rotoli da 21 m.

The membranes Alkorplan Touch are not only printed but also embossed and incised, obtaining a tridimensional effect. They have a thickness of 2 mm. Supplied in rolls of 21 m.