

CPA SRL

CENOVNIK
KATALOG

2024/25



Profesionalna oprema za bazen

SADRŽAJ

SADRŽAJ



www.cpa-piscine.it

Na web mestu CPA možete preuzeti digitalnu verziju cenovnika, koji se uvek ažurira.
Registrirajte se ili prijavite i pregledajte sav sadržaj proizvoda.

STRUKTURA BAZENA

STRUKTURA

SET KOMPONENTI

OPREMA

OPREMA

TEHNIČKE PROSTORIJE

TEHNIČKI BUNKERI

UDOBNI BAZEN

UDOBNOST

JAVNI BAZENI

JAVNI BAZENI

PRIBOR

PREKRIVKE

PUMPE ZA DOZIRANJE

PUMPE ZA DOZIRANJE

ČIŠĆENJE I TRETMAN

NADZEMNI BAZENI

SPA

WELLNESS

CPA^{SRL}

UZ TEBE SVAKI DAN

C.P.A. s.r.l. je jedan od najvećih italijanskih dilera u sektoru bazena. Naša misija je **isporučiti, dizajnirati i proizvesti najbolje komponente za javne i stambene bazene za naše kupce, na italijanskom i evropskom tržištu**. Naše duboko poznavanje sektora omogućava nam da ponudimo proizvode izrađene od visokokvalitetnih materijala i pažljivo dizajniranih kako bi osigurali maksimalnu efikasnost i pouzdanost.

Inovativnost, kontinuirana potraga za najnaprednijim tehnološkim rešenjima i kvaliteta proizvoda oduvek su bile glavne vodeće vrednosti firme, uz veliku predanost stvaranju **ekološki održivog i svesnog pristupa bazenu**. Zapravo, naša vizija je **ponuditi inovativna i održiva rešenja za transformaciju i olakšavanje iskustva naših kupaca u bazenu**. Osim toga, zahvaljujući prisutnosti tima stručnih tehničara, firma je u mogućnosti pružati pomoć, jamčeći svojim kupcima potpunu i pouzdanu uslugu, da bi bili uz njih svaki dan.

Svi materijali koji se koriste za proizvodnju unutar C.P.A. s.r.l. grupe su **isključivo italijanski** materijali. Osim toga, radna snaga je specijalizovana za primene moderne opreme, visoko je kvalifikovana a proizvodni procesi su visoko automatizovani.

Širom **Evrope** postoje i druga **skladišta** u kojima deluju lokalni agenti koji predstavljaju C.P.A. s.r.l. asortiman.

Firma je znači opremljena najsavremenijom **prodajnom i distributivnom organizacijom** koja pruža ne samo tehničku pomoć, već i važnu aktivnost s rezervnim delovima, zahvaljujući širokoj raspoloživosti na zalihama.





ROBNE MARKE GRUPE



C.P.A. s.r.l. OGGI - C.P.A. s.r.l. sada

12.300

ARTIKALA

20

SKLADIŠTA

240

PERSONAL
Osoba

CPA_{SRL} USLUGE -



SKLAPANJE OPREME

SERVISNA I ZA POPRAVKE OPREME
RADIONICA

SERVISNI I CENTAR ZA OPRAVKE
ROBOTA ČISTAČA

TEHNIČKA PODRŠKA

*Aktivnosti koje se vrše u glavnom sedištu u Roddiju (CN)

U ITALIJI - Italija

PIEMONTE - centralno skladište

Via Don Demetrio Castelli 71,
12060 Roddi (CN)
Telefon: +39 0173 615693
cpa@cpa-piscine.it

LOMBARDIA -skladište

Via Michelino Besozzo 3,
20900 Monza (MB)
telefon: +39 0392 840993
cpamonza@cpa-piscine.it

VENETO -skladište

Via Strà 166,
37030 Köln ai colli (VR) tel:
045 6151308
cpacolognola@cpa-piscine.it

TOSCANA -skladište

Via Galileo Galilei, 56040
Lavoria - Crespina Lorenzana
(PI) tel: +39 050 9350003
cpacrespina@cpa-piscine.it

EMILIA ROMAGNA - skladište

Via Cavour 3, 40012
Calderara di Reno
(BO) tel: +39 051
0910601
cpabologna@cpa-piscine.it

LAZIO - skladište

Via Tazio Nuvolari, 8
00019 Tivoli Terme
(RM) tel: + 39 0774
1930002
cpativoli@cpa-piscine.it

PUGLIA - skladište

Via delle Industrie 4,
72017 Ostuni (BR)
Telefon: +39 0831 330452
cpaostuni@cpa-piscine.it

CAMPANIA - skladište

Zona Ind. Nola, Via
Contrada Difesa, snc
Roccarainola (NA) tel: +39
081 19460963
cpacampania@cpa-piscine.it

CALABRIA - skladište

Via Pasquale Cerra 56 , 88046
Lamezia Terme (CZ)
tel: +39 0968 1873070
cpalamezia@cpa-piscine.it

SICILIA -skladište

Via E. Mattei 4/6, Z.I. Calderaro,
93100 Caltanissetta (CL)
Telefon: +39 0934 27928
cpacaltanissetta@cpa-piscine.it

SARDINIJA -skladište

Via Algeria, 4
07026 Olbia (OT)
Telefon: +39 0789 050 019
cpaolbia@cpa-piscine.it

ŠIROM SVETA -

GRČKA – skladište i agent

Thesi 2 Peyka, 19300 - Aspropyrgos
T: +30 693 6460334
info@cpa-greece.gr

FRANCUSKA - skladište

132, Rue de la République 42500
- Le Chambon-Feugerolles
info@cpa-france-piscines.fr

RUMUNIJA

- Skladištenje i proizvodnja

Str Principala nr 357/B jud
Temišvar
deposiz.bucuresti@cpa-piscine.com

SRBIJA - CRNA GORA - BOSNA (ISTOK) -skladište

C.P.A. POOLS D.O.O. - skladište
Zemunska 273, 11277
Ugrinovci, Beograd
T: +381 116240289
cpa@cpa-pools.rs

RUSIJA

- Proizvodnja i skladištenje

Машиностроительный, д.16
г. Ростов-на-Дону, Советский р-н.
T: +7 863 3105110
cpa@cpa-bassejny.ru

HRVATSKA - BOSNA (ZAPAD) -SLOVENIJA -skladište

C.P.A. POOLS d.o.o. - skladište
Žegoti 33, 51215 Kastav, Hrvatska
T: +385 (51) 215713
info@cpa-pools.hr

ALBANIJA -skladište

Rruga Nacionale Tiranë- Shkodër
km 22, Borizane, Kruj

MALTA - Agent

Elgas Srl
Voditelj područja Lucio Esposito
Lavina T: +356 799 99 013
lucioespositolavina@cpa-piscine.com

POLJSKA - agent

Area Manager Pawelo
Leszczuk T: +48 518 061 626
paweloleszczuk@cpa-piscine.com

CPA srl

NAŠA REŠENJA ZA EKOLOŠKI PRIHVATLJIV BAZEN

C.P.A. srl usvaja svestan pristup bazenu, razvijajući i birajući niz ekološki svesnih proizvoda kako bi doživeli jedno ekološki održivije iskustvo u bazenu.

FILTRACIJA -

Sistem filtracije neophodan je za bazen koji je uvek čist i efikasan i danas je konačno moguće stvoriti održiv sistem recirkulacije smanjenjem potrošnje energije i vode. Tehnologija visokoefikasnih pumpi za filtriranje, kao što je **Ambra pumpa**, i tehnologija trajnog magneta kao što je **Serena pumpa**, koja štedi do 85% električne energije u upoređenju s tradicionalnim pumpama s optimiziranom modulacijom brzine. GL **asortiman filtera** sa umetkom smanjuje količinu vode potrebne za pranje filtera, pri istoj brzini protoka s filtrom za masu. Novi mediji nadopunjuju tradicionalne sisteme, kao što je Eco **Filter Glass**, s kojim je moguće uštedeti do 25% vode tokom protivstrujnog pranja filtera.



GREJANJE I PREKRIVKE

Toplotne pumpe jesu najbolje rešenje za regulaciju temperature bazena, osiguravajući visoke performanse u odnosu na nisku potrošnju energije. Toplotne pumpe sa inverter tehnologijom, poput **Indiana Evo-P** i **Indiana Evo-V**, omogućuju smanjenu potrošnju energije u upoređenju s potrošnjom toplotne pumpe ON / OFF i 1/10 električnog ili plinskog grejanja za bazene.

Prekrivka bazena u poliesterskoj ceradi ili šipkama presvučenim PVC-om neophodna je pri zagrevanju bazena ekološki prihvatljivim pristupom: smanjuje disperziju toplote u periodima nekorištenja, blokira isparavanje vode i štiti od prljavštine, što vodi do energetske i hidro uštede, a time i finansijske uštede.



TRETMAN VODE

Zahvaljujući automatskim rešenjima za pročišćavanje vode, obnova bazenske vode se smanjuje i optimizira, kontroliše vodeni ambijent i čini ga stalno zdravim i sigurnim.

Integracija sistema za dezinfekciju visokih performansi, kao što su **UV lampe**, glatka i linearna elektroliza Uniko MG ili niska koncentracija soli **Uniko MG** s magnezijum solima, sanifikacija vode odvija se prirodno, sa umerenim uticajem, uz smanjenje CO₂, zahvaljujući proizvodnji in situ supstanci potrebnih za dezinfekciju na licu mesta.



RASVETA -

LED tehnologija razlikuje se od tradicionalnih lampi sa užarenom niti u pogledu trajnosti, raznolikosti boja i, pre svega, potrošnji energije. Naše **LED lampe troše oko 80% manje energije** od halogenih, s dužim vekom trajanja, u srazmeri 5/6 puta u upoređenju s halogenim lampama. Naš asortiman sastoji se od LED dioda visokih performansi koje su u skladu s evropskim standardima kvaliteta.



Merlino

PAMETAN i koristan



WI-FI veza za jednostavno upravljanje putem telefona



Povezivanje putem APP-a za daljinsko upravljanje bazenom

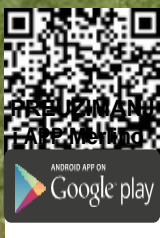

Merlino je elektronski tablet za **kontrolu automatizovanu bazena od kuće**, sposobna upravljati svim njegovim aspektima: filtracijom, obradom vode, grejanjem, rasvetom putem namenske APLIKACIJE. Sistem daljinskog upravljanja omogućava vam **proveru više sistema sa jedne kontrolne table** i primanje obavestjenja u realnom vremenu o radnom statusu svakog od njih. Namenski server cloud omogućuje **pristup podacima i povezanim uređajima, bilo gde u svetu**, gde postoji mogućnost internetske veze. Očitava i upravlja sondama nivoa, za skimer ili prelive, temperaturnu sondu i senzor protoka, napaja direktno ventil za punjenje.

PREDNOSTI - Prednosti

kompletna kontrola bazena direktno s mobilnog telefona

Upravljanje bazenom čak i daljinski autonomno putem besplatne aplikacije za IOS i Android

Ekološki održivo, smanjuje potrošnju energije i hemikalija

Sve funkcije i podaci skupa nadohvat su vam ruke, uvek, čak i daleko od kuće

Upozorenja alarmom u slučaju bilo kakvih problema

Koristite bazen sigurno, podešavanjem tajmera parametara vode

JEDNOSTAVNIM TIPKANJEM U APLIKACIJI MERLINO MOŽETE KONTROLISATI:



RASVETU

Pomoću tajmera svetla možete programirati paljenje svetla, upravljati bojama, naporviti prest, uključiti ih u ritmu muzike!



FILTRACIJU

kontrola vremena filtracije s mogućnošću podešavanja prilagođenih tajmera čak i sezonskii, kontrolisajući do 4 pumpe (jednostruka ili promjenjiva brzina)



TEMPERATURU

Moguće je stalno pratiti temperaturu vode u bazenu. Hlađenjem i/ili zagrevanjem vode, čime se produžuje period korišćenja bazena.



HIDROMASAŽU

Jednostavnom komandom možete uroniti u beskonačan broj mehurića planirajući trenutke čiste blagodeti



DEZINFEKCIJU

Moći ćete proveriti vrednost značajnih parametara nivoa vode kako bi se mogli sprečiti bilo kakvi problemi i osigurati da je voda uvek savršena



ALARME

Upozorenje kad god se generiše alarm. Na primer, ako hemikalije ponestane, ako bi se nivo u kompenzacijskom rezervoaru premnogo spustio ili digao, itd.

MERLINO I PROIZVODI SMART



FILTRACIJA
Serena pumpa



RASVETA
Reflektor Real



Sigurnosna Prekrivka



TRETMAN
Hlorolong i pumpa za doziranje



GREJANJE PUMPA
indiana Evo-V

Uključivanje i isključivanje filtracijskog sistema pomoću **Pumpe Serena**, **REAL reflektora** i toplotnih pumpi **Indiana Evo** može se lako **programirati zahvaljujući Merlinu**. Osim toga pravovremenom i preciznom kontrolom bitnih parametara vode, potrošnja hemijskih proizvoda kao što je **Hlorolong** također će se svesti na ono što je strogo potrebno. Sa Merlinom, **optimizacija i ušteda** su osigurani.



C.P.A. srl povremeno nudi instalaterima bazena, praktične obrazovne kurseve o **proizvodima i tehničko-komercijalnu obuku za prodaju**. Plan obuke koji je izradio C.P.A. srl osmišljen je s ciljem da ponudi raznolik i celovitu ponudu i da kupci: **budu pripremljeni, informisani o najnovijim trendovima, tehnički kompetentni, konkurentni i komercijalno komunikativni kako bi se usredsredili na ciljeve.**

Svaki kurs se održava u učionici, 1 ili 2 uzastopna dana od strane kvalifikovanog nastavnika dostupnog za ažuriranja i produbljivanja argumenata, zavisno od tekućeg kursa, praktičnim vežbama. Posle svakog kursa predaje se potvrda o pohađanju i informativni materijal za konsultaciju.



POSTAVLJANJE I ZAVARIVANJE BAZENSKE MEMBRANE



INSTALACIJA ISOBLOK KOMPLETA



TEMELJNO PROUČAVANJE SISTEMA BAZENA I AŽURIRANJE PROPISA U.N.I



PRODAJA I IZGRADNJA BAZENA
Prodaja i gradnja bazena

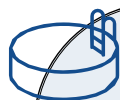

WELLNESS PROGRAM
Wellness program

Putem web stranice www.cpa-piscine.it, u odjeljku "kursevi obuke", moguće je pregledati celi predlog formiranja i registrovati se jednostavnim klikom za željeni konkurs ili zatražiti više informacija na e-mail scuola@cpa-piscine.it.



OTKRIJTE WEB STRANICU cpa-piscine.it



Na web stranici C.P.A. Piscine moguće je pregledavati bezbroj promotivnih i tehničkih sadržaja na našim proizvodima: brošure, **priručnici i tehnički listovi** kako biste uvijek bili informisani i saznali više o svakom detalju.

Jednostavnim **klikom** možete se registrovati, a ulaskom u privatno područje možete:

- Narudžbenicu poslati **automatski**, putem odgovarajućeg obrasca, po povoljnoj ceni
- **Pregledati i preuzimati kataloge proizvoda** i cenovnike rezervnih delova koji se uvijek ažuriraju
- Pristupiti području promocija i **iskoristiti blic ponude i sezonsku rasprodaju**
- **Registrovati CPA uređaje za daljinsku konekciju** kako biste mogli pristupiti namenskim portalima

Kako preuzeti tehnički materijal



1 STVARANJE ACCOUNTA

Registracijom na www.cpa-piscine.it web stranici

Stvorite svoj račun registracijom na web-sajtu www.cpa-piscine.it



2 UĐI U TEHNIČKO PODRUČJE

Naći ćete priručnike, Tehničke šeme, module i brošure



3 PREUZMI DOKUMENTA

Dostupno odmah na tvom PC

SAJMOVI I SKUPOVI



C.P.A. s.r.l. prisutan je na **većim sajmovima iz sektora, u Italiji i inostranstvu**, jer je važno sresti se sa našim kupcima i predstaviti se potencijalnim.

Sajmovi i skupove koje održavamo u našim skladištima prilika su za predstavljanje **najnovijih trendova, inovacija u tehnološkom području i ilustriranje karakteristika naših proizvoda** i njihove funkcionalnosti.



SAJMOVI -iz branše



Eurexpo
Lyon,
Francuska



Bazen i spa sajam
u Bologni sajamski
okrug



Aquaterm
Moskva



Romexpo

SEKTORSKA UDRUŽENJA



#SAFETY FIRST Prekrivka

4

Sigurnosna prekrivka je automatska prekrivka pogodna za većinu postojećih i novih bazena, koja garantuje **sigurnost za celu familiju**. Ova prekrivka je, zapravo, namenski osmišljena kako bi **se sprečilo bilo kakvo upadanje u vodu** zahvaljujući svojoj ceradi visoke čvrstoće od 600 gr / m2 koja se polože na vodu i pušta da klizi niz bočne šine .

Sigurnosna prekrivka **može podneti težinu pri slučajnom padu**. Jednostavnom komandom, automatska prekrivka se odmotava kako bi pokrila bazen i namotava se, nestajući u namenskom tehničkom kućištu, osiguravajući u isto vreme sigurnost i elegantan i diskretan izgled.



Sigurnosna prekrivka u skladu je **sa sigurnosnim standardima** i isporučuje se zajedno s ceradom, ramom, električnim motoreduktorom, vodičama i potopnom pumpom

Standardna cerada:

- Težina 600 g/m2
- Otpornost na toplinu + 70°C
- Otpornost na hladnoću - 30°C



6 RAZLOGA ZA ODABIR SIGURNOSNE PREKRIVKE

SIGURNOST I ZAŠTITA

Jednostavna za otvaranje i zatvaranje , u skladu je s evropskim (NF P90-308) i američkim (ASTM F1346-91) sigurnosnim standardima.



UŠTEDA ENERGIJE I TROŠKOVA

- Sprečava isparavanje vode
- Održava temperaturu dugo vremena
- Duži vek trajanja bazena



BAZEN ČIST I SPREMAN ZA UPOTREBU

Zahvaljujući hermetičkom zatvaranju koje blokira ulazak prašine, lišća i insekata i sprečava stvaranje algi i mikroorganizama.



IZOLACIJA

Korištenje ojačane PVC cerade povećava izolaciju za 25% u upoređenju s tradicionalnim ceradama.



IZDRŽLJIV I DUGOTRAJAN

Testirane, izdržljive i dugotrajne komponente. Minimalno održavanje.



SVESTRAN

Ugrađuje se na bazene svih oblika, zakrivljenih ili kvadratnih, novih ili postojećih



SAVRŠENA ZA SVE NOVE ILI POSTOJEĆE BAZENE



Automatska prekrivka 4 godišnja doba **odgovara** većini **postojećih ili bazena u izgradnji**.

Za one koji već postoje , vođice su smeštene na pod uz ivicu i motorizovani valjak mora biti umetnut u kućište koje je smešteno na jednoj strani bazena. **Za novoizgrađene bazene** šine su umetnute u profil vođice dok je motorizovani valjak smešten u posebnom kućištu. Svi sistemi su dizajnirani i proizvedeni kako bi postigli **pouzdan i kvalitetan sistem prekrivke stavlajući vašu sigurnost i sigurnost vaše familije na prvo mesto**.

REAL

NOVI ASORTIMAN ABS PRIBORA prema STANDARDIMA EU-A



Iz kontinuiranog procesa istraživanja i razvoja proizvoda za tržište bazena rođen je **Real**: novi asortiman ABS komponenti koje je u potpunosti dizajniralo tehničko odeljenje C.P.A. srl koji osigurava visok standard kvaliteta.

Usis za hidromasažnu opremu GM-9

Pribor koji se zida omogućava protok i dotok vode, optimizirajući njene tokove, zbog čega ga je važno pažljivo odabrati.

Naš asortiman sastoji se od ABS-a s anti-UV tretmanom i u skladu je s evropskim standardima (zavisno od modela): UNI EN 13451-1, UNI EN 13451-3, UNI EN 16582-1, UNI EN 16713-2.



PRELIVNI SKIMERLX7



GM-12 MLAZNICE
POVRATNE ARMATURE GM-12



USISNA MLAZNICA SA
ČEPEM GM-21



GM-15 MLAZNICE



GM-18 MLAZNICE
POVRATNE ARMATURE GM-18



USISNA MLAZNICA SA
ČEPEM GM-27



USISNA MLAZNICA SA
ČEPEM GM-24



SLIVNICI PODA RAVNE
REŠETKE GM-30



T-VENTURI ZA
HIDROMASAŽNE INSTALACIJE

Odaberite između skimera, mlaznica, donjih odvoda, t-venturi, pribora koji najbolje odgovara bazenu, bez obzira na vrstu (bazen sa lajnerom, betonskim, monoblok, fiberglas ili panelni bazeni). Svaki pribor dostupan u 5 boja.



svetloplava



plavi



sivi



pesak



antracit

NOVITETI -



MERLINO

je elektronska ploča za kontrolu kućne automatizacije bazena, sposobna upravljati svim aspektima: filtracijom, obradom vode, grejanjem, rasvetom putem namenske APLIKACIJE.



SERENA PUMPA

Pumpa s trajnim magnetom, promjenjive brzine za bazene, štedi do 85% električne energije u upoređenju s konvencionalnim pumpama s optimiziranom modulacijom brzine.



INDIANA EVO-V

Tehnološki unapređena toplotna pumpa s Wi-Fi kontrolom putem APP-a i kontrolom temperature putem ekrana. Zahvaljujući rotacionom inverter kompresoru, omogućava značajnu uštedu energije u upoređenju s tradicionalnim pumpama.

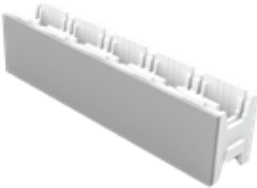

W.DENSITY. K80

Lagan, robustan i toplotno izolacioni stiropor blok, W.DENSITY. K80 je najinovativniji iz našeg asortimana: omogućuje jednostavnu, brzu i ekonomičnu montažu strukture bazena.



HIDROMASAŽNA MLAZNICA

Hidromasažna mlaznica s efektom blastera, s fiksnom glavom i mešanjem vazduha i vode za venturi efekt, garantuje snažnu i intenzivnu masažu.

REAL



PUMPA ARCA

Centrifugalna pumpa s uređajem za drenažu za hidromasažu s motorom s kontinuiranim radom i IP55 zaštitom. Telo sa usisnim i ispusnim nosačima u polipropilenu i motornim vratilom od nerđajućeg čelika AISI 420.



FILTER COLORADO

Filter s prozirnim poklopcem, manometrom, sistemom za recirkulaciju sa rukama i gornjim difuzorom s brzim rastavljanjem kako bi se olakšala radnja održavanja.



PODOVI: MEMBRANA ZA PODOVE BAZENA

Fleksibilna PVC ojačana membrana, namenski dizajnirana za oblaganje površina zona oko bazena, vodenih parkova, svlačionica i tuš prostora.



SPA DUETTO

Duetto je profesionalni SPA, izrađen u Italiji, osmišljena za naknadnu ugradnju u wellness okruženja, jedinstveno rešenje koje uklanja arhitektonske barijere. Idealno za ugradnju u istorijskim i zavisnim kontekstima.



TOP SUPER 3000 GLAVČINA

Robotski čistač programiran za čišćenje, automatsko usisavanje prljavštine i ostataka s dna i zidova. Potpuno čisti stambene bazene. Može se upravljati direktno sa telefona pomoću personalizirane aplikacije.



UV-C LAMPA 4 ALL

UV-C svjetiljke su izdržljive, održive i jednostavne za ugradnju. UV-C 4ALL sadrži Duplex kućište s visokom otpornošću na koroziju, što ga čini pogodnim i za bazene sa sistemima elektrolize soli.



SAUNA INFRACRVENI SOLE

Kabina od jele s upravljačkom pločom, prozirnim vratima i prozorima od kaljenog stakla, LED rasvetom i MP3 s Bluetoothom.



UNIKO

Uniko Mg je inovativni sistem za pročišćavanje vode koji se temelji na mešavini magnezijum soli koje donose benefite koži.



DECLO-R-APID

Komplet za dehlorisanje/tretman vode, na jednostavan i neposredan način, pomoću senzora protoka: sistem je dostupan u dve verzije, s elektromagnetskom pumpom od 5 l/h ili s peristaltičkom pumpom od 2 l/h.

SADRŽAJ

STRUKTURA BAZENA

Izoblok stiropor blokovi/	22
EPS BLOK / EPS BLOK	31
Bazen Twenty /	34
Ego čelični bazeni	39
Garden mini bazen	40
Liberty mini bazen	42
Tirrena mini bazen	44
Samostojeći bazen Mediterranea i Adriatica	46
Prelivne ivice i pribori i kompenzacione kade	50
Akrilne stepenice	58
Stepenice ispod lajnera	61
Prekrivke	68
Pločice i bordure	91
Proizvodi za pločice i bordure	98

SET KOMPONENTI BAZENA

SET pribora za zidanje	102
Komplet za filtriranje	103
Set fittinga i cevi	104
Set fittinga i ventila	108
Set za čišćenje i hemikalije	110

OPREMA BAZENA

Pribor za zidanje	116
Filteri	155
Pumpe	165
Protivstrujno plivanje i pribor	180
Hidromasaža i pribor	181
Kompletni hidromasažni setovi	193
Fitinzi I cevi	195
Električne table	211

TEHNIČKA KUĆIŠTA

Mašinski prostori	234
Filtrirajući zidovi	247
Monoblok postolje	248

COMFORT POOL

Toplotne pumpe	256
Izmjenjivači toplote	265
Električni grejači	271
Solarni paneli	274
Odvlaživači vazduha	278
Elektroliza soli i doziranje pH vrednosti / Elektroliza soli i pH doza	281
Dezinfekcija vode / Dezinfekcija vode	285

JAVNI BAZENI

Filteri	300
Pumpe	309
Predfilteri	314
Upravljačke ploče	315
Pribor za zid	316
Instrumenta	317
Pribori	318
Fizioterapeutski bazeni	324
Hidraulični i električni podizači pacijenata	324
Spora plovna reka Rio Grande	325

SADRŽAJ

PRIBOR ZA BAZEN

Solarni tuševi / Solarni tuševi	330
Kadice za pranje nogu / Umivaonici za pranje nogu	337
Podne i plutajuće fotelje / Po podu ili plutajućim foteljama	338
Tobogani i igre od fiberglasa / Tobogani i igre u stakloplastici	338
Sigurnosni uređaji / Sigurnosni uređaji	339
Stepenice i rukohvati / Ljestve i rukohvati	346
Skakaonice / Daske za ronjenje	348
Mlazevi i vodopadi	349
Fizioterapeutsko sedište / Fizioterapijsko sjedalo	356
Krevetci od inox čelika / Ležaljke od nehrđajućeg čelika	357
Hidromasaža / Hidromasažom	358

PREKRIVKE

Roletna prekrivke	364
Automatske prekrivke	391
Prekrivke sa šipkama	393
Zimske prekrivke	397
Protivmrazni proizvodi	400
Letnje izotermičke prekrivke	401
Motalice	402

DOZIRNE PUMPE

Pumpe za doziranje	406
Sastavljene paneli za doziranje	410
Oprema za elektrolizu	413
Dozatori tableta hlora i broma	413
Kontejner za skladištenje	413
Pribor pumpe za doziranje	414

ČIŠĆENJE I TRETMAN

Hidraulični i na baterije čistači	422
Automatski čistači	424
Automatska sredstva za čišćenje velikih bazena	426
Pribor za održavanje	427
Tester	434
Hemikalije	440

NADZEMNI BAZENI

Rondò bazeni / Rondò bazeni	452
Nadzemni od drveta i pribor / Drveni nadzemni i pribor	456
Nadzemni samostojeći/ Samonosivi iznad zemlje	460
Dodatna oprema za nadzemne bazene / Dodatna oprema za nadzemne bazene	465
Peščani filteri / Filtri za pijesak	468
Sistemi protiv komaraca / Sustavi protiv komaraca	469

WELLNESS - WELLNESS

Liberty SPA	476
Yui SPA	478
Tirrena mini bazen	482
Samostojeći bazen Adriatica	484
Duetto SPA	487
Hidromasaža Spa	488
Klasične saune i pribor	509
Infracrvene saune	510
Profesionalne saune	512
Vrtne saune	513
Bačvaste saune	514
Peći	517
Turska kupatila i pribor	520
Tuš kabina	525

Struktura

STRUKTURA

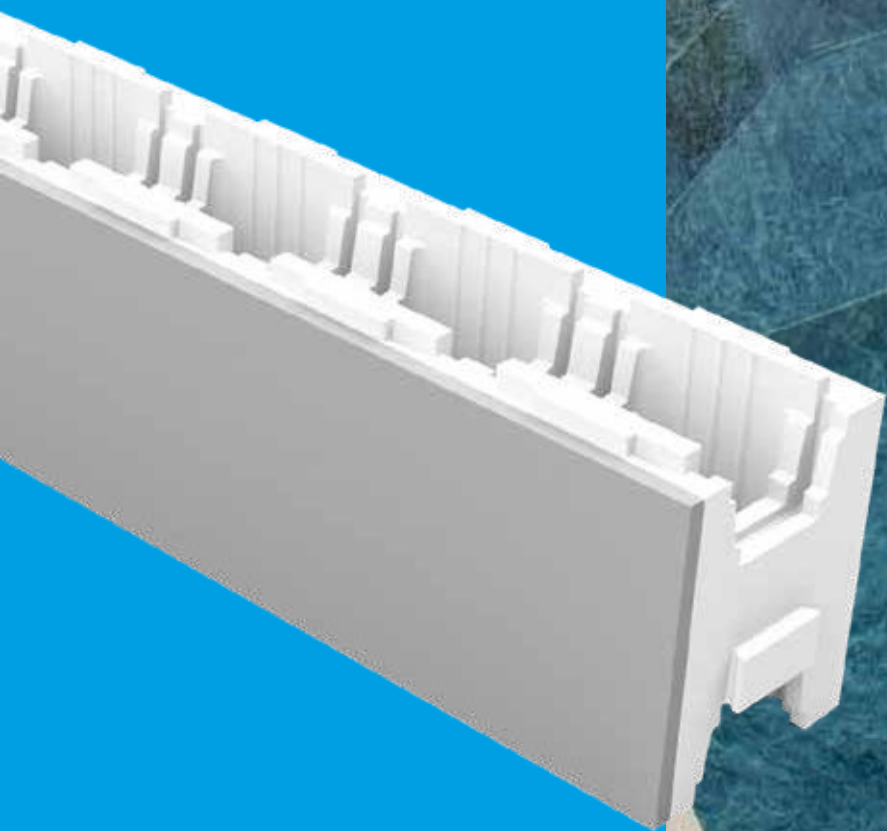

1



Sadržaj

	ISOBLOK STIROPOR BLOKOVI
22	TEHNIČKE KARAKTERISTIKE
26	ISOBLOK KS SERIJA
30	KOMPLET ACQUAFORM BAZENA
31	EPS BLOK
33	W.DENSITY. K80
	PANELI TWENTY
34	ČELIČNI PANELI OBOSTRANO PLASTIFICIRANI
36	SET BAZENA TWENTY
39	EGEO ČELIČNI PANELI MINI BAZENI
41	GARDEN
42	LIBERTY
44	TIRRENA
	SAMOSTOJEĆI BAZEN MEDITERRANEA
46	MEDITERRANEA
48	ADRIATICA PRELIVNI
	PRELIVNE IVICE
50	STANDARDNE IVICE FINSKE I PLAŽA
51	REŠETKE
53	UGAONE PLOČE
55	KOMPENZACIJSKE KADE
	STEPENICE
58	AKRILNE STEPENICE
60	STEPENICE REZERVNI DELOVI
61	ISPOD LAJNERA STEPENICE
62	STEPENICE S KLUPOM SA HIDROMASAŽNIM KOMPLETOM
65	VODOOTPORNE BOJE I SILIKONI
	OBLOGE
68	AQUALINER 75/100 I LAJNER U JEDNOJ BOJI PVC ILI ŠTAMPANI
70	DELIFOL ASORTIMAN
71	RENOLIT ASORTIMAN
78	PROIZVODI ZA ALKORPLAN
79	ELBTAL ASORTIMAN
85	ZAVARIVE TRAKE I LINERLOCK
86	VODICE, TIPLE I PROFILI
87	PROSTIRKE I KOMPLEMENTI ZA LAJNER
89	LEISTER
	PLOČICE I IVICE
91	IVICA BAZENA PISCINA ROSALIND PROTIVKLIZNA
92	IVICA BAZENA BAZENA GLATKA
92	PROTIVKLIZNI TRETMAN
93	IVICA ESPACE
95	IVICA CASTELLANE
96	MEMBRANA ZA PODOVE
	ZAŠTITA I NEGA
97	PROIZVODI ZA ZAŠTITU I NEGU

ISOBLOK STIROPOR BLOKOVI

Konstruktivni sistem za armiranobetonske bazene s dvostruko izoliranim zidovima.

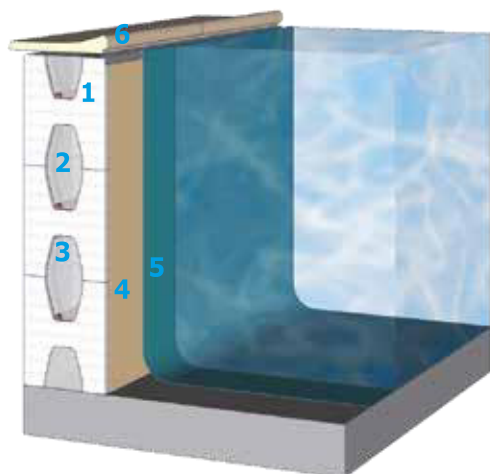

SASTAV

- 1 ISOBLOK
- 2 ARMATURNI GVOŽĐE
- 3 BETON
- 4 ZAŠTITNA *PODLOGA*
- 5 PVC LINER
- 6 ALUMINIJSKA VOĐICA ZA OBLAGANJE



TEHNIČKE KARAKTERISTIKE

C.P.A. srl je direktni proizvođač ISOBLOK sistema, preoblikovanog vodootpornog stiropor sistema, jednostavnog i brzog za izlivanje betonskih bazena.

Zahvaljujući svojoj lakoći i kompaktnosti, proizvod se isporučuje sa sigurnosnom ambalažom za transport. ISOBLOK je jednostavan i bez napora za sastavljanje, osiguravajući čisto gradilište, bez upotrebe teške opreme.

Njegovo vodootporno svojstvo omogućuje bazenu da duže održava temperaturu koju voda doseže u letnjim mjesecima i smanjuje potrošnju energije sistema grejanja uz podršku odgovarajuće nepromočive prekrivke.

ISOBLOK proizvodi C.P.A. Proizvodna linija uključuje 3 vrste BLOKOVA u 3 različite veličine. 7 linija štancovanja

ISOBLOK 1250

Za pravougaone oblike, mm 1250x275x250

ISOBLOK 2000

Za slobodne oblike, u dimenzijama mm 1250x275x250

ISOBLOK 300KS

Za pravougaone oblike, mm 1250x300x250

ISOBLOK 301KS

Za slobodne oblike, u dimenzijama mm 1250x300x250

SASTAV

Isoblok je:

- Prozračan, ali vodootporan
- netoksičan, inertan
- Kompatibilan s cementom, betonom, zidovima, cementnim malterima, vodootpornim / bitumenskim membranama, vodootpornim malterima za ugradnju mozaika / pločica
- Pogodan za širok raspon primena
- Jednostavan za transport, uskladištenje, instalaciju
- Samogasiv
- 100% se može reciklirati
- Prilagodljiv bilo kojoj podlozi
- Ne deformiše se

Isoblok ima:

- Izvanredne tehničke karakteristike
- Izvrsna svojstva toplotne izolacije
- Vodootpornost
- Nizak rizik od toksičnosti u slučaju požara
- Homologacija klase I
- Mogućnost vremenske konzervacije

Osim toga , Isoblok:

- ne topi se u vodi
- s vremenom se ne može razgraditi
- ne podržava rast gljivica, buđi, bakterija
- ne sadrži hlorofluorokarbure niti hidrohlorofluoro karbure
- ne ispušta toksične gasove
- ne predstavlja opasnost po zdravlje
- ne zagađuje okolinu
- ne stvara nered i prljavštinu

GLAVNE FAZE UGRADNJE



KORAK 1

Bazen se trasira na terenu i napravi se iskop željenim dimenzija. Potom se postavlja temelje.



KORAK 2

Postavljaju je zatim blokovi stiropora sa ugradnjom gvozdene armature i na kraju se ugrađuju svi delovi za zidanje.



KORAK 3

Beton se izlije Pomoću pumpe ova se operacija provodi jednostavnim punjenjem ISOBLOK-a betonom .



KORAK 4

Postavljaju se lajsne i PVC membrana sa umetanjem priрубnica i opreme. Na kraju se bazen puni pijaćom vodom.



PETI KORAK

Pustite mašti na volju prigodnim uređenjem ambijenta koji okružuje bazen (popločavanjem kamenom, drvenim podovima itd.).

PRIMERI OBLIKA ZA REALIZACIJU SA ISOBLOKOM
EXAMPLES OF SHAPES ACHIEVABLE WITH ISOBLOK



KLASIČAN



RUBIN



PORTOFINO



RELAX

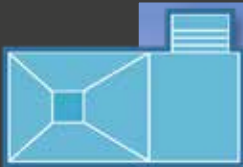

BEACH
TIME



TAORMINA



SORRENTO



FIRENZE





AMALFI

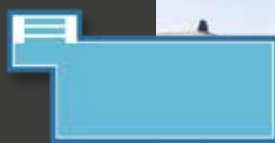

CARAIBI



ELBA

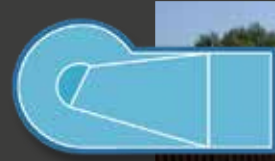

ISCHIA

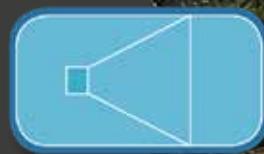

MONTECARLO

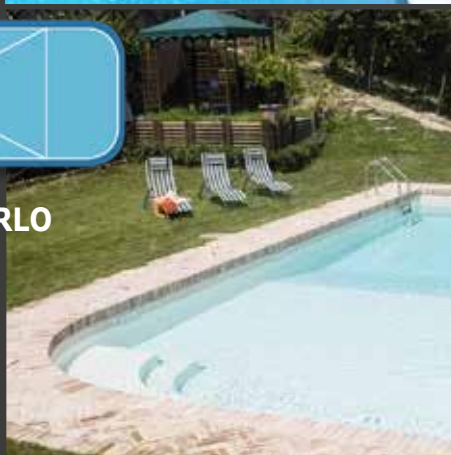

SEABEACH



TROPEA



SLOBO
DNI
OBLIK



ISOBLOK KS SERIJA

Novi stiropor blokovi serije Isoblok 300KS - 301KS zadržava iste karakteristike kao i serija ISOBLOK 1250, ali sa sledećim prednostima:

- Visina bloka 30 cm
- Povećana elastičnost za zakrivljene zidove
- Štancovanje u polistirenu visoke gustine za pravougaone i zidove slobodnog oblika
- Odlivak betona, fino doziranje, gustoća C25/30

Šifre	Opis	Dimenzije	Cena
1063000	ISOBLOK 300KS – pravougaoni zid	1250x300x250	21,00 € ukj.
1063001	ISOBLOK 301KS – zid slobodnog oblika	1250x300x250	22,90 € ukj.

Šifre	Opis/opis	Cena
1063002	Čep za zatvaranje uglova	1,50 €
1063003	Čep za zakrivljene stiropor blokove Ref.A	1,65 €
1063004	Čep za zakrivljene stiropor blokove Ref.B	1,65 €
1063005	Čep za zakrivljene stiropor blokove Ref.C	1,65 €
1063006	Čep za zakrivljene stiropor blokove Ref.D	1,65 €
1063007	Čep za zakrivljene stiropor blokove Ref.E	1,65 €
1063008	Čep za zakrivljene stiropor blokove Ref.F	1,65 €
1063009	Čep za zakrivljene stiropor blokove Ref.G	1,65 €
1063010	Čep za zakrivljene stiropor blokove Ref.H	1,65 €



TAGLILOK ZA REZANJE I OBRADU ISOBLOKA

Šifra	Opis	Cena
1050640	Taglioblok	960,00 €
1050641	Rezervna žica	8,00 €



KOMPLET ACQUAFORM BAZENA



**Mod.
CLASSICA**



KOMPONENTE SETA

Dim. u m			Sup m ²	Zapremina m ³				Dubina				Mašin ski prosto r	Usis	Protok	SK	BC	PS	PF	Filter	HP pum pa	Brzina proto ka m ³ /h
U	B	C		FP	FT	FP	FT	FP	FT	FP	FT										
7	3	-	21	25	28	31,5	34	1,20	1,80	1,50	2,00	Big Mac	n°2 Ø50	n°1 Ø50	1	2	-	2	Medit.500	0,75	10
8	4	-	32	38	43	48	52	1,20	1,80	1,50	2,00	Big Mac	n°2 Ø50	n°1 Ø50	1	2	-	2	Medit.500	0,75	10
9	3	-	27	32	36	40,5	44	1,20	1,80	1,50	2,00	Big Mac	n°2 Ø50	n°1 Ø50	1	2	-	2	Medit.500	0,75	10
9	4	-	36	43	48	54	58	1,20	1,80	1,50	2,00	Big Mac	n°2 Ø50	n°1 Ø50	1	2	-	2	Medit.500	0,75	10
10	4	-	40	48	56	60	65	1,20	1,80	1,50	2,00	Sedici	n°4 Ø50	n°3 Ø50	2	3	1	2	Medit.650	1	16
10	5	-	50	60	71	75	83	1,20	1,80	1,50	2,00	sedici	n°4 Ø50	n°3 Ø50	2	3	1	2	Medit.650	1	16
11	5	-	55	66	78	82,5	91	1,20	1,80	1,50	2,00	sedici	n°4 Ø50	n°3 Ø50	2	3	1	2	Medit.650	1	16
12	5	-	60	72	85	90	99	1,20	1,80	1,50	2,00	sedici	n°4 Ø50	n°3 Ø50	2	3	1	2	Medit.650	1	16
12	6	-	72	86	102	108	119	1,20	1,80	1,50	2,00	Comodo	n°4Ø50-n°1Ø63	n°3 Ø50	3	4	1	2	Medit.750	2	23
13	6	-	78	94	110	117	129	1,20	1,80	1,50	2,00	Comodo	n°4Ø50-n°1Ø63	n°3 Ø50	3	4	1	2	Medit.750	2	23
14	5	-	70	84	99	105	116	1,20	1,80	1,50	2,00	Comodo	n°4Ø50-n°1Ø63	n°3 Ø50	3	4	1	2	Medit.750	2	23
14	6	-	84	101	119	126	139	1,20	1,80	1,50	2,00	Comodo	n°4Ø50-n°1Ø63	n°3 Ø50	3	4	1	2	Medit.750	2	23
14	7	-	98	118	138	147	162	1,20	1,80	1,50	2,00	Comodo alto	n°4Ø50-n°1Ø63	n°3 Ø50	3	5	1	2	Medit.900	3	30
15	7	-	105	126	147	157,5	172	1,20	1,80	1,50	2,00	Comodo alto	n°4Ø50-n°1Ø63	n°3 Ø50	3	5	1	2	Medit.900	3	30
16	7	-	112	134	158	168	185	1,20	1,80	1,50	2,00	Comodo alto	n°4Ø50-n°1Ø63	n°3 Ø50	4	5	1	2	Medit.900	3	30
16	8	-	128	154	181	192	211	1,20	1,80	1,50	2,00	Globo	n°5 Ø50	n°4 Ø50	4	6	1	2	n°2 Medit.750	1,5	42
18	9	-	162	194	228	243	267	1,20	1,80	1,50	2,00	Globo	n°5 Ø50	n°4 Ø50	6	8	1	2	n°2 Medit.750	1,5	42
20	10	-	200	240	282	300	329	1,20	1,80	1,50	2,00	Master	n°4 Ø50	n°5 Ø50	8	10	1	2	n°2 Medit.750	3	54

**Legenda unosa
tablice**

Riv = obloga

L = lajner

M =membrana

Asp = Dotok

Mand= Protok

SK= skimer

BC = mlaznice

PS = usisna mlaznica sa čepom

PF = podni slivnik



CENE KOMPLETA

U	Dim u m		Komplet bazena 1.20 ravno dno		Komplet bazena 1.20 kupanja u jami		Komplet bazena 1.50 ravno dno		Peskarjena bela ivica		Ivica Rosalind		Izotermni poklopac tinjca Ljetno plava		Zimska prekrivka + cevi	
	B	C	Šifra	€	Šifra	€	Šifra	€	Šifra	€	Šifra	€	Šifra	€	Šifra	€
7	3	-	2120025	10.088,00	2122015	10.088,00	2150020	10.395,00	1021118	1.252,00	1021518	1.190,00	1061019	357,00	1063019	620,00
8	4	-	2120026	10.351,00	2122016	10.351,00	2150021	10.891,00	1021119	1.444,00	1021519	1.401,00	1061020	544,00	1063020	773,00
9	3	-	2120027	10.351,00	2122017	10.351,00	2150022	10.891,00	1021120	1.444,00	1021520	1.401,00	1061021	459,00	1063021	737,00
9	4	-	2120028	10.614,00	2122018	10.614,00	2150023	12.441,00	1021121	1.571,00	1021521	1.532,00	1061022	612,00	1063022	835,00
10	4	-	2120029	13.372,00	2122019	13.372,00	2150024	14.145,00	1021122	1.666,00	1021522	1.637,00	1061023	680,00	1063023	904,00
10	5	-	2120030	13.605,00	2122020	13.605,00	2150025	14.377,00	1021123	1.762,00	1021523	1.743,00	1061024	850,00	1063024	1.009,00
11	5	-	2120031	14.062,00	2122021	14.062,00	2150026	14.900,00	1021124	1.921,00	1021524	1.848,00	1061025	935,00	1063025	1.086,00
12	5	-	2120032	14.386,00	2122022	14.386,00	2150027	16.611,00	1021125	2.017,00	1021525	1.953,00	1061026	1.020,00	1063026	1.155,00
12	6	-	2120033	17.718,00	2122023	17.718,00	2150028	18.789,00	1021126	2.113,00	1021526	2.058,00	1061027	1.223,00	1063027	1.282,00
13	6	-	2120034	17.982,00	2122024	17.982,00	2150029	18.819,00	1021127	2.240,00	1021527	2.164,00	1061028	1.325,00	1063028	1.359,00
14	5	-	2120035	17.982,00	2122025	17.982,00	2150030	18.819,00	1021128	2.240,00	1021528	2.164,00	1061029	1.190,00	1063029	1.301,00
14	6	-	2120036	18.245,00	2122026	18.245,00	2150031	19.083,00	1021129	2.336,00	1021529	2.269,00	1061030	1.427,00	1063030	1.443,00
14	7	-	2120037	19.408,00	2122027	19.408,00	2150032	21.764,00	1021130	2.431,00	1021530	2.374,00	1061031	1.665,00	1063031	1.577,00
15	7	-	2120038	20.958,00	2122028	20.958,00	2150033	22.028,00	1021131	2.559,00	1021531	2.480,00	1061032	1.784,00	1063032	1.668,00
16	7	-	2120039	21.434,00	2122029	21.434,00	2150034	22.504,00	1021132	2.654,00	1021532	2.585,00	1061033	1.903,00	1063033	1.752,00
16	8	-	2120040	26.805,00	2122030	26.805,00	2150035	27.875,00	1021133	2.750,00	1021533	2.690,00	1061034	2.175,00	1063034	1.907,00
18	9	-	2120041	29.199,00	2122031	29.199,00	2150036	30.501,00	1021134	3.068,00	1021534	3.032,00	1061035	2.752,00	1063035	2.260,00
20	10	-	2120042	39.607,00	2122032	39.607,00	2150037	40.975,00	1021135	3.387,00	1021535	3.348,00	1061036	3.398,00	1063036	2.648,00



Klasičan

KOMPLET ACQUAFORM BAZENA

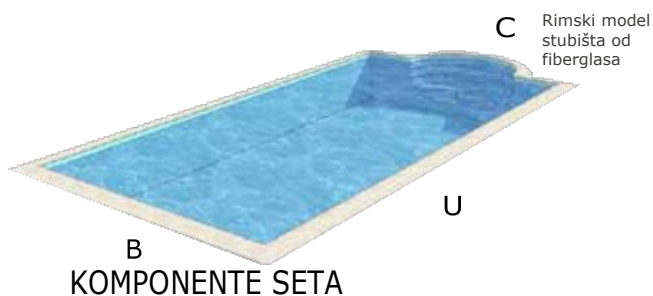
Mod.
RELAX

KOMONENTE SETA

Dimenzije [m]			Sup [m ²]	Zapremina [m ³]				Dubina [m]				Mašinski prostor	Dotok	Protok	SK	BC	PS	PF	Filter model	Pumpa [KS]	Brzina protok [m ³ /h]
U	B	C		FP 1,20	FT 1,20	FP 1,50	FT 1,50	FP 1,20	FT 1,20	FP 1,50	FT 1,50										
8,75	3,5	2,5	29	35	39	43	46	1,20	1,80	1,50	2,00	Big Mac	n°2 Ø50	n°1 Ø50	1	2	-	2	Medit. 500	0,75	10
9,75	4	2,5	37	44	49	55	59	1,20	1,80	1,50	2,00	Big Mac	n°2 Ø50	n°1 Ø50	1	2	-	2	Medit. 500	0,75	10
10,5	4	2,5	40	48	53	60	64	1,20	1,80	1,50	2,00	Big Mac	n°2 Ø50	n°1 Ø50	1	2	-	2	Medit. 500	0,75	10
11	4,5	3	47	56	64	70	77	1,20	1,80	1,50	2,00	Sedici	n°4 Ø50	n°3 Ø50	2	3	1	2	Medit. 650	1	16
12	5,5	3	62	74	83	93	100	1,20	1,80	1,50	2,00	Sedici	n°4 Ø50	n°3 Ø50	2	3	1	2	Medit. 650	1	16
13,5	6	3	76	92	102	114	124	1,20	1,80	1,50	2,00	Comodo	n°4Ø50-n°1Ø63	n°3 Ø50	3	4	1	2	Medit. 750	2	23
14,5	6	3	82	99	112	123	134	1,20	1,80	1,50	2,00	Comodo	n°4Ø50-n°1Ø63	n°3 Ø50	3	4	1	2	Medit. 750	2	23
16	6	3	91	110	123	137	148	1,20	1,80	1,50	2,00	Comodo alto	n°4Ø50-n°1Ø63	n°3 Ø50	3	5	1	2	Medit. 900	3	30

CENE KOMPLETA

U	B	C	Komplet bazena 1.20 ravno dno		Alat bazen 1,20 za skok jama		Komplet bazena 1.50 ravno dno		Peskarena bela ivica		Ivica Rosalind		Izoterm.Prekrivka Letnja plava		Zimska prekrivka + cevi	
			Šifra	€	Šifra	€	Šifra	€	Šifra	€	Šifra	€	Šifra	€	Šifra	€
8,75	3,5	2,5	2120077	12.537,00	2122067	12.537,00	2150072	12.889,00	1021165	1.570,00	1021765	1.565,00	1061068	771,00	1063068	914,00
9,75	4	2,5	2120078	12.811,00	2122068	12.811,00	2150073	13.396,00	1021166	1.729,00	1021766	1.723,00	1061069	854,00	1063069	984,00
10,5	4	2,5	2120079	12.842,00	2122069	12.842,00	2150074	13.426,00	1021167	1.793,00	1021767	1.802,00	1061071	1.146,00	1063071	1.106,00
11	4,5	3	2120080	16.285,00	2122070	16.285,00	2150075	17.003,00	1021168	1.955,00	1021768	1.955,00	1061072	1.250,00	1063072	1.313,00
12	5,5	3	2120081	16.548,00	2122071	16.548,00	2150076	17.499,00	1021169	2.178,00	1021769	2.166,00	1061073	1.354,00	1063073	1.392,00
13,5	6	3	2120082	20.410,00	2122072	20.410,00	2150077	21.426,00	1021170	2.401,00	1021770	2.377,00	1061074	1.604,00	1063074	1.543,00
14,5	6	3	2120083	20.673,00	2122073	20.673,00	2150078	21.689,00	1021171	2.529,00	1021771	2.482,00	1061075	1.729,00	1063075	1.642,00
16	6	3	2120084	22.099,00	2122074	22.099,00	2150079	23.347,00	1021172	2.688,00	1021772	2.640,00	1061076	1.916,00	1063076	1.779,00



Relax

KOMPLET ACQUAFORM BAZENA



**Mod.
RUBINO**



KOMPONENTE SETA / KIT COMPONENTS

Dimenzije [m]			Sup [m ²]	Zapremina [m ³]				Dubina [m]				Mašinski prostor	Dotok	Protok	SK	BC	PS	PF	Filter model	Pumpa [KS]	Brzina protoka [m ³ /h]
U	B	C		FP 1,20	FT 1,20	FP 1,50	FT 1,50	FP 1,20	FT 1,20	FP 1,50	FT 1,50										
8,20	4,0	3,0	28,5	34	37	43	45	1,20	1,80	1,50	2,00	Big Mac	n°2 Ø50	n°1 Ø50	1	2	-	2	Medit. 500	0,75	10
9,20	4,0	3,0	28,5	34	37	43	45	1,20	1,80	1,50	2,00	Big Mac	n°2 Ø50	n°1 Ø50	1	2	-	2	Medit. 500	0,75	10
10,60	5,0	4,0	44,0	53	58	66	70	1,20	1,80	1,50	2,00	Sedici	n°4 Ø50	n°3 Ø50	2	3	1	2	Medit. 650	1	16
10,90	5,0	4,0	45,0	54	60	67,5	72	1,20	1,80	1,50	2,00	Sedici	n°4 Ø50	n°3 Ø50	2	3	1	2	Medit. 650	1	16
12,50	6,0	5,0	62,5	75	83	94	101	1,20	1,80	1,50	2,00	Sedici	n°4 Ø50	n°3 Ø50	2	3	1	2	Medit. 650	1	16

CENE KOMPLETA

U	Dim u m	B	C	Komplet bazena 1.20 Ravno dno		Komplet bazena 1.20 za skok jama		Komplet bazena 1.50 Ravno dno		Peskarena bela ivica		Ivica Rosalind		Izotermni poklopac tinjca Ljetno plava		Zimska prekrivka + cev	
				Šifra	€	Šifra	€	Šifra	€	Šifra	€	Šifra	€	Šifra	€	Šifra	€
8,2	4	3	2120085	10.773,00	2122075	10.773,00	2150080	11.454,00	1021177	1.670,00	1021577	1.848,00	1061082	604,00	1063082	810,00	
9,2	4	3	2120086	10.814,00	2122076	10.814,00	2150081	11.497,00	1021178	1.741,00	1021578	2.025,00	1061083	500,00	1063083	846,00	
10,6	5	4	2120087	14.162,00	2122077	14.162,00	2150082	14.872,00	1021179	1.990,00	1021579	2.310,00	1061084	917,00	1063084	1.078,00	
10,9	5	4	2120088	14.232,00	2122078	14.232,00	2150083	15.188,00	1021180	2.061,00	1021580	2.345,00	1061085	1.104,00	1063085	1.111,00	
12,5	6	5	2120089	14.794,00	2122079	14.794,00	2150084	17.224,00	1021181	2.239,00	1021781	2.665,00	1061086	1.354,00	1063086	1.407,00	



Rubino

Za ostale modele pogledajte cenovnik Seta-a

EPS BLOK

EPS BLOK je novi izotermički sistem stiropor blokova preformiranih oblikovan u pravim i već zakrivljenim oblicima, jednostavan i brz za odlivke betonskih bazena. Zahvaljujući svojoj lakoći i spojevima za lakše slaganje, EPS BLOK omogućuje jednostavan transport, a takođe ima:

- izotermna svojstva koja omogućuju vodi da duže održava temperaturu koja se postigne
- Lakša montaža zakrivljenih zidova
- Polistirensko štancovanje visoke gustine za ravne i unapred zakrivljene zidove
- betonski odlivak za fino doziranje gustine C25/30

EPS BLOK 1000 PRAVOUGAONI OBLIK

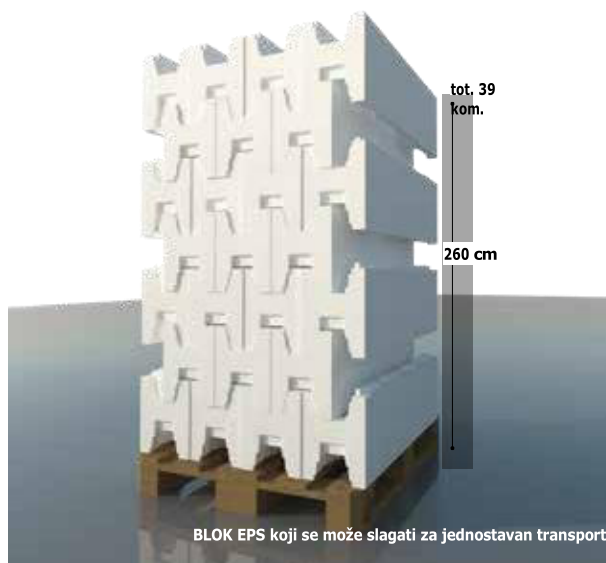
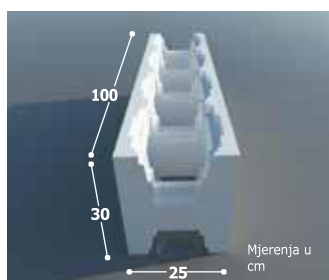
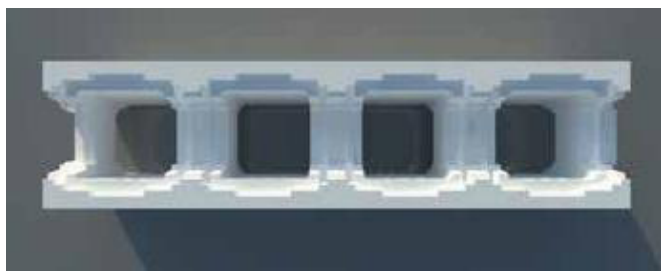

Šifre	Opis	Cena
1064000	EPS BLOK 1000 ravno u paletama od 39 kom. Svaki	16,70 €
1064007	EPS BLOK 1000 ravno u pakiranjima od 9 kom. svaki	16,90 €

ČEPOVI ZA ZATVARANJE UGLOVA



Zatvaranje ugla čepom

Šifre	Opis	Cena
1064001	Kutija čepova za zatvaranje uglova A + B (25 kom A + 25 kom B)	80,00 €

EPS BLOK KRIVINA 90°

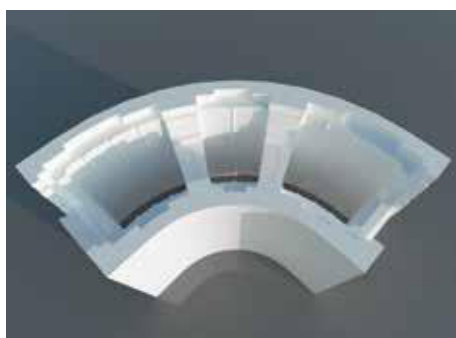
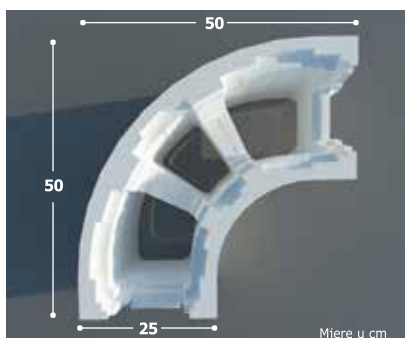

Šifre	Opis	Cena
1064002	EPS BLOK angulo 90° curvo / 90° zakrivljeni kut EPS BLOK	13,50 €

EPS BLOK UNAPRED ZAKRIVLJENI MODULI

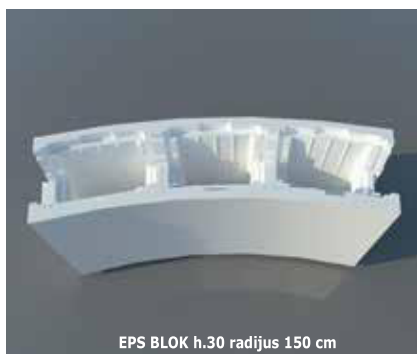

EPS BLOK h.30 radijus 150 cm

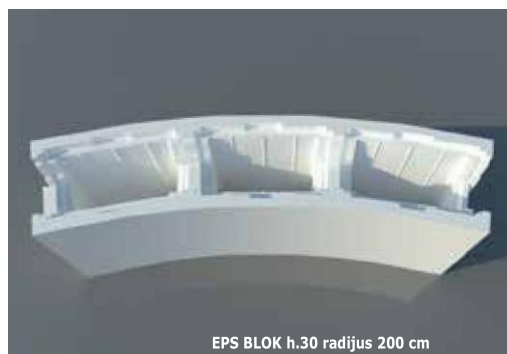

EPS BLOK h.30 radijus 200 cm



Šifre	Opis/opis	Cena
1064003	EPS BLOK unapred zakrivljeni radijus 150	16,30 €
1064004	EPS BLOK unapred zakrivljeni radijus 200	20,90 €

NEKI OSTVARIVI OBLICI U EPS BLOKU

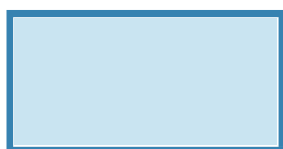

Pravougaoni EPS BLOK + tampon čepovi



Pravougaoni EPS BLOK + tampon čepovi



Pravougaoni i unapred zakrivljeni EPS BLOK (radijus 150/200cm) + tampon čepovi

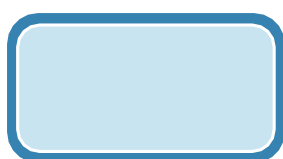

EPS BLOK pravougaoni + EPS BLOK 90° krivina
Pravokutni EPS BLOK + EPS BLOK u obliku 90°



Ravni EPS BLOK + Unapred zakrivljeni EPS BLOK (radijus 150/200cm)
Pravokutni EPS BLOK + unaprijed postavljene EPS BLOK (radijus 150/200cm)

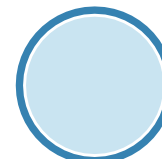

Unapred zakrivljeni EPS BLOK (radijus 150/200cm)
Unaprijed postavljene EPS BLOK (radijus 150/200cm)

W.DENSITY.K80

NEW



Stiropor blok duple gustine W. DENSITY.K80 najnoviji je iz našeg asortimana stiropor blokova: njegova unutrašnja strana visoke gustine karakteriše velika mehanička otpornost protiv slučajnih udara na gradilištu i izvanredan je za realizaciju bazena kako ukopanih tako i nadzemnih. Lak, čvrst i termički izolovan stiropor blok W.DENSITY.K80. omogućava jednostavnu, brzu i jeftinu montažu strukture bazena do dubine od 2,1 m.

The double-density formwork W. DENSITY. K80 is the most innovative in our range of formwork. Its very high density inner face characterizes its high mechanical resistance against accidental impacts on the construction site and is perfect for the construction of in-ground or above-ground swimming pools. Lightweight, strong and insulating, the W. DENSITY. K80 enables simple, quick and economical assembly of the pool structure up to a depth of 2,1 m.

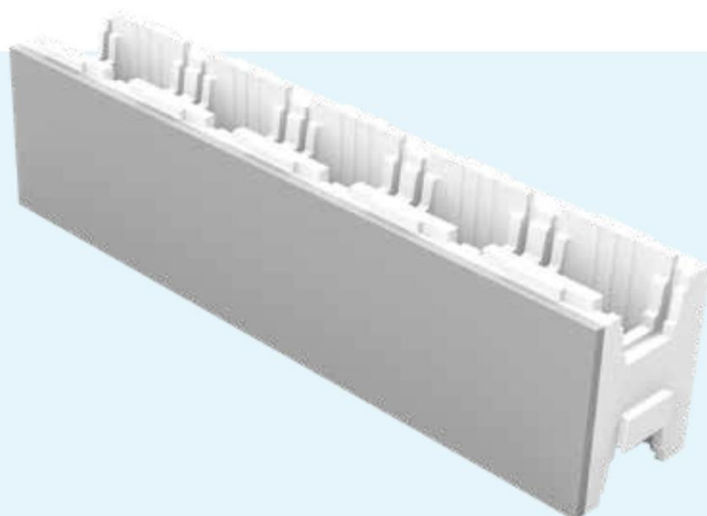

ČVRST



EKOLOŠKI ODRŽIV

PRILAGODLJIV
I BRZTERMO
IZOLACIONI**KARAKTERISTIKE W.DENSITY.K80**

- Omogućava samovezeuju strukturu bez potrebe za dodatnim vezivnim elementima
- Unutrašnja površina vrlo visoke gustine
- Čvrstina i brza instalacija
- Velika mehanička otpornost za prijem faze livenja i izrade.
- Optimalna izolacija sa smanjenje potrebe za grejanjem i potrošnje.
- Malo rezova i maloškarta za čisto gradilište
- Laka i brza instalacija opreme za bezen

THE CHARACTERISTICS OF W. DENSITY. K80

Allows the creation of a self-bonding structure without the need for additional constraining elements; Very high density inner surface; Robustness and speed of installation; High mechanical strength to support the casting and construction phase; Optimal insulation to limit heating requirements and consumption; Few cuts and little waste for a clean construction site; Easy and fast installation of tank accessories.

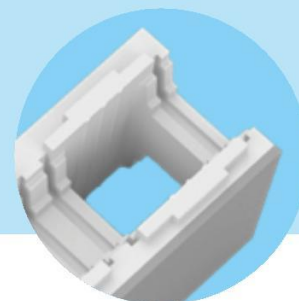

Za tampon čepove imati u vidu str. 31 / Refer to p. 31 for plugging keys.

ZA INFORMACIJE I CENE KONTAKTIRAJTE NAS / FOR INFO AND PRICES CONTACT US

**KONSTRUKCIONI SISTEM ČELIČNIH PLASTIFICIRANIH PANELA
PLASTIFICATI CONSTRUCTION SYSTEM IN BIPLASTIFIED STEEL**

PANELS

Panel za skimer/mlaznica MT3/MT14 Panel za skimer/mlaznica MT3/MT14	Visina 1,20 m		Visina 1,50 m	
	ŠIFRA	CENA	ŠIFRA	CENA
Panel ŠIRINA da 0 a 1 m pieno panel width from 0 to 1 m solid	4020200	256,70 €	4020300	317,90 €
Panel širine da 0 a 1 m za mlaznicu MT3 panel width from 0 to 1 m for return fitting MT3	4020201	260,90 €	4020301	322,10 €
Panel širine da 0 a 1 m za skimer MT3 panel width from 0 to 1 m for skimmer MT3	4020202	265,30 €	4020302	326,50 €
Panel širine od 0 a 1 m za projektor MT3 panel width from 0 to 1 m for projector MT3	4020203	265,30 €	4020303	326,50 €
Panel largo da 0 a 1 m pieno pretagliato flessibile panel width from 0 to 1 m solid pre-cut flexible	4020204	328,70 €	4020304	437,50 €
Pannello largo da 0 a 1 m za mlaznicu MT3 pretagliato flessibile panel width from 0 to 1 m for return fitting MT3 pre-cut flex	4020205	333,70 €	4020305	442,50 €
Panel širine od 0 a 1 m za skimer MT3 unapred rezan fleksibilni panel width from 0 to 1 m for skimmer MT3 pre-cut flex	4020206	338,80 €	4020306	447,80 €
Panel širine od 0 do 1 m za reflektor MT3 unapred rezan fleksibilni panel width from 0 to 1 m for projector MT3 pre-cut flex	4020207	338,80 €	4020307	447,80 €
Panel širine od 0 a 1 m puni zakrivljeni panel width from 0 to 1 m solid curved	4020208	442,50 €	4020308	531,50 €
Panel širine od 0 do 1 m za mlaznicu MT3 zakrivljen panel width from 0 to 1 m for return fitting MT3 curved	4020209	447,60 €	4020309	536,80 €
Panel širine od 0 do 1 m za skimer MT3 zakrivljen panel width from 0 to 1 m for skimmer MT3 curved	4020210	452,90 €	4020310	541,90 €
Panel širine od 0 do 1 m za reflektor MT3 c panel width from 0 to 1 m for projector MT3 curved	4020211	452,90 €	4020311	541,90 €

PANEL TWENTY/SEKCIJE I UKLAPAJUĆA AKSONOMETRIJA

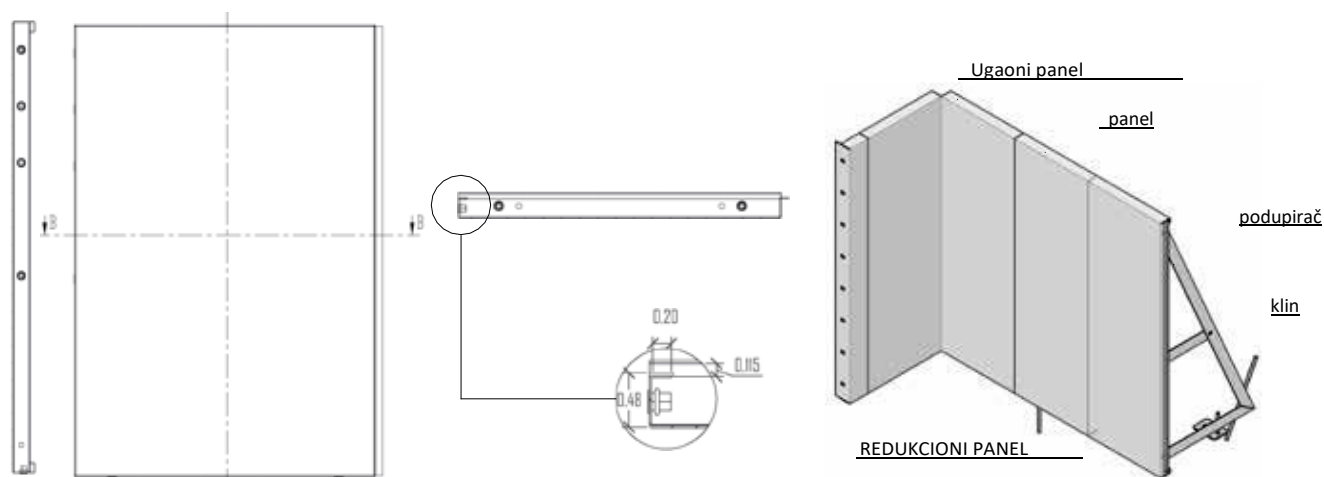

Panel za skimer/mlaznica REAL	visina 1,20 m		Visina 1,50 m	
	šifra	cena	šifra	cena
Panel širine od 0 a 1 m za mlaznicu REAL ili projektor panel width from 0 to 1 m for return fitting REAL or projector	4020252	260,90 €	4020366	298,10 €
Panel širine od 0 a 1 m za skimer REAL panel width from 0 to 1 m for skimmer REAL	4020254	260,90 €	4020367	298,10 €
Panel širine od 0 do 1 m prethodno izrezan fleksibilan za mlaznicu REAL ili projektor panel width from 0 to 1 m pre-cut flex for return fitting REAL or projector	4020255	333,70 €	4020368	413,80 €
Panel širine od 0 do 1 m prethodno izrezan fleksibilan za skimer REAL panel width from 0 to 1 m pre-cut flex for skimmer REAL	4020256	333,70 €	4020369	413,80 €
Panel širine od 0 do 1 m krivi za mlaznicu REAL ili projektor panel width from 0 to 1 m curved for return fitting REAL or projector	4020258	447,60 €	4020370	503,90 €
Panel širine od 0 do 1 m krivi za skimer REAL panel width from 0 to 1 m curved for skimmer REAL	4020259	447,60 €	4020371	503,90 €

Panel za skimer/mlaznica	visina 1,20 m		visina 1,50 m	
	šifra	cena	šifra	Cena
Panel širine od 0 do 1 m za skimer panel width from 0 to 1 m for skimmer	4020236	265,30 €	4020336	302,50 €
Panel širine od 0 do 1 m za skimer prethodno rezan fleksibilni panel width from 0 to 1 m skimmer pre-cut flex	4020237	338,80 €	4020337	419,10 €
Panel širine od 0 do 1 m za skimer krivi panel width from 0 to 1 m for skimmer curved	4020238	452,90 €	4020338	508,90 €
Panel širine od 0 do 1 m za skimer LX7 panel width from 0 to 1 m for skimmer LX7	4020239	265,30 €	4020339	302,50 €
Panel širine od 0 do 1 m za skimer LX7 prethodno rezan fleksibilan panel width from 0 to 1 m for skimmer LX7 pre-cut flex	4020240	338,80 €	4020340	419,10 €
Panel širine od 0 a 1 m za skimer LX7 krivi panel width from 0 to 1 m for skimmer LX7 curved	4020241	452,90 €	4020341	508,90 €

Panel ugaoni i special/Corner panel and special	h120		h150	
	šifra/ code	Cena/price	šifra/ code	Cena/ price
Ugaoni panel 50x50 / panel corner 50x50	4020212	275,30 €	4020312	312,50 €
Specijalni panel za spoj stepenica od fiberglasa special panel for connecting fiberglass stairs	4020213	340,70 €	4020313	385,30 €
Profil spajanja uglova/ profile corners junction	4020214	31,70 €	4020314	35,40 €
Podupirač + podesivi nogar / buttress + adjustable foot	4020215	48,60 €	402031	51,70 €
Ankeri / anchoring pegs	4020108	2,80 €	4020108	2,80 €
Šrafovi D 12x30 / screws D 12x30	1035831	0,54 €	1035831	0,54 €

PRELIVNA IVICA TWENTY NISKA TWENTY LOW OVERFLOW EDGE

šifra/ code	Opis/description	Cena/ price
4020401	Prelivna ivica niska, prava / low overflow edge straight	129,50 €
4020402	Niska prelivna ivica sečena za slobodan oblik / low overflow edge cut for free form	169,10 €
4020403	Niska prelivna ivica ugao 50x50 / corner 50x50 low overflow edge	283,00 €
4020404	Pravougaoni držač / support bracket	17,90 €
4030101	Spojnica za prelivne ivice / overflow edge joint	8,10 €
4020111	Komplet spojnih šrafova za prerlivnu ivicu	3,40 €

KOMPLET PANELA TWENTY - BAZEN KEROS / CRETA TWENTY PANELS KIT - KEROS / CRETA POOL

Mod. KEROS/ CRETA

SET KEROS SERIJE 40 U SASTAVU

Struktura kompletna od čeličnih panela, odgovarajućim bočnim pojačanjima, pričvrstnim nosačima i šarafima. Unutrašnja obloga lajner od PVC. Filtrirajući zid IKARUS već montiran i spreman za upotrebu, ne zahteva hidraulične intervencije; kompletan sa skimerom, mlaznicama za dotok vode, filter, pumpa, fitinzi i cevi. Električna kutija sa satom za programiranje, stepenice od čelika inox sa 3 protivklizna stepenika.

KEROS KIT 40 SERIES COMPLETE OF

Structure complete with steel panels, side reinforcements, mounting brackets and bolts to complete. Liner in PVC. Filtering wall IKARUS already assembled and ready to operate, requires no plumbing, complete with skimmer, inlets water, filter, pump, pipe for the skimmer, fittings and pipes. Electrical panel with clock programming, stainless steel staircase with three anti-slip steps.

SERIE 40	Dim m		Set bazena 1,20 ravno dno		set bazena 1,20 jama skok		Set pbazena 1,50 ravno dno		Bela peskirana ivica		Ivica Rosalind	
	A	B	cod	€	cod	€	cod	€	cod	€	cod	€
	6	3	4020519	12.742,00 €	4020525	12.742,00 €	4020531	13.488,00 €	1021117	1.158,00 €	1021517	1.111,00 €
7	3	4020520	13.449,00 €	4020526	13.449,00 €	4020532	14.286,00 €	1021118	1.286,00 €	1021518	1.216,00 €	
8	4	4020521	14.834,00 €	4020527	14.834,00 €	4020533	15.850,00 €	1021119	1.477,00 €	1021519	1.426,00 €	
9	3	4020522	14.834,00 €	4020528	14.834,00 €	4020534	15.850,00 €	1021120	1.477,00 €	1021520	1.426,00 €	
9	4	4020523	15.656,00 €	4020529	15.656,00 €	4020535	16.761,00 €	1021121	1.605,00 €	1021521	1.584,00 €	
10	4	4020524	16.219,00 €	4020530	16.219,00 €	4020536	18.380,00 €	1021122	1.700,00 €	1021522	1.689,00 €	

Set CRETA SERIE 50 u sastavu / CRETA KIT 50 SERIES COMPLETE OF

- Struktura kompletna sa čeličnim panelima, bočna odgovarajuća pojačanja, pričvrstni nosači.
- Šarafi u kompletu.
- Unutrašnja obloga membrana od PVC.
- Aluminjumska vodica za kačenje obloge.
- Mašinski prostor od fiberglasa spremna za upotrebu, Peščani filter sa šestopoložajnim ventilo, monofazna elektropumpa sa predfilterom povezne cevi, , kuglasti ventili i fitting za kompletiranje.
- Set poveznih cevi, fitting i lepak.
- Skimer, usisni uz pumpu sa korpicom za otpadak, plutajućem preklopom, priključak za prepunjenost. Potisne mlaznice bazena.
- Električna kutija sa satom za programiranje vremena filtriranja
- pumpe, povezne kablo, spoljne kablo sa utičnicom Schuko.
- Structure complete with steel panels, side reinforcements, fixing brackets.
- Bolts to complete.
- Inner coating in PVC membrane.
- Aluminium guide for hooking coating.
- Technical housing in fiberglass, ready to use, sand filter with six-way valve, single-phase electric pump with pre-filter, connecting pipes, ball valves and fittings to complete.
- Kit of connecting pipes, fittings and glue.
- Suction skimmer complete of basket, fin floating, overflow attack.
- Inlet fittings water in the pool.
- Electrical panel with clock for time programming filtration pump, connecting cable, external cable with Schuko plug.

SERIE 50	Dim u m			Komplet bazena 1,20 ravno dno		Set bazena 1,20 skok jama		Set bazena 1,50 ravno dno		Bela ivica peskirana		Ivica Rosalind	
	A	B	C	cod	€	cod	€	cod	€	cod	€	cod	€
	8	4	-	4020410	14.802,00 €	4020427	14.802,00 €	4020444	15.879,00 €	1021119	1.477,00 €	1021519	1.426,00 €
9	3	-	4020411	14.802,00 €	4020428	14.802,00 €	4020445	15.879,00 €	1021120	1.477,00 €	1021520	1.426,00 €	
9	4	-	4020412	18.323,00 €	4020429	15.510,00 €	4020446	16.677,00 €	1021121	1.605,00 €	1021521	1.584,00 €	
10	4	-	4020413	17.943,00 €	4020430	17.943,00 €	4020447	19.193,00 €	1021122	1.700,00 €	1021522	1.689,00 €	
10	5	-	4020414	18.851,00 €	4020431	18.851,00 €	4020448	20.680,00 €	1021123	1.762,00 €	1021523	1.742,00 €	
11	5	-	4020415	20.041,00 €	4020432	20.041,00 €	4020449	21.478,00 €	1021124	1.921,00 €	1021524	1.847,00 €	
12	5	-	4020416	20.749,00 €	4020433	20.749,00 €	4020450	22.265,00 €	1021125	2.017,00 €	1021525	1.952,00 €	
12	6	-	4020417	23.715,00 €	4020434	23.715,00 €	4020451	25.331,00 €	1021126	2.113,00 €	1021526	2.057,00 €	
13	6	-	4020418	24.432,00 €	4020435	24.432,00 €	4020452	26.138,00 €	1021127	2.240,00 €	1021527	2.163,00 €	
14	5	-	4020419	24.432,00 €	4020436	24.432,00 €	4020453	26.138,00 €	1021128	2.240,00 €	1021528	2.163,00 €	
14	6	-	4020420	25.623,00 €	4020437	25.623,00 €	4020454	27.419,00 €	1021129	2.336,00 €	1021529	2.268,00 €	
14	7	-	4020421	26.871,00 €	4020438	27.354,00 €	4020455	29.239,00 €	1021130	2.431,00 €	1021530	2.373,00 €	
15	7	-	4020422	28.544,00 €	4020439	28.544,00 €	4020456	30.520,00 €	1021131	2.559,00 €	1021531	2.478,00 €	
16	7	-	4020423	29.355,00 €	4020440	29.387,00 €	4020457	31.903,00 €	1021132	2.654,00 €	1021532	2.583,00 €	
16	8	-	4020424	34.066,00 €	4020441	34.548,00 €	4020458	36.703,00 €	1021133	2.750,00 €	1021533	2.689,00 €	
18	9	-	4020425	38.965,00 €	4020442	38.965,00 €	4020459	41.614,00 €	1021134	3.068,00 €	1021534	3.004,00 €	
20	10	-	4020426	49.196,00 €	4020443	49.196,00 €	4020460	52.235,00 €	1021135	3.387,00 €	1021535	3.320,00 €	

SET PANELA TWENTY - BAZEN LIPARI / JAMAICA TWENTY PANELS KIT - LIPARI / JAMAICA POOL



Mod. LIPARI/ JAMAICA

SET LIPARI SERIJE 40 U SASTAVU

Struktura kompletna čeličnim panelima, bočna odgovarajuća pojačanja, pričvrtni nosači i šrafovi za kompletiranje. Unutrašnja obloga lajner PVC. Filtrirajući zid Ikarus već montiran i spreman za upotrebu, ne zahteva hidraulične intervencije; u kompletu sa skimerom, mlaznicama za dotok vode, filterom, pumpom, fittingom i cevima. Električna tabla sa satom za programiranje, čelične stepenice inox sa 3 protivklizna stepenika.

LIPARI KIT SERIES 40 COMPLETE OF

Structure complete with steel panels, side reinforcements, fixing brackets and bolts. Inner lining in PVC. IKARUS filter wall already assembled and ready to operate, it does not require hydraulic interventions; complete with skimmer, water inlet fittings, filter, pump, fittings and pipelines. Electric panel with programming clock, stainless steel staircase with three anti-slip steps.

SERIE 40	Dim in m			Kit piscina 1,20 fondo piano		Kit piscina 1,20 fossa tuffi		Kit piscina 1,50 fondo piano		Bordo Bianco sabbiato		Bordo Rosalind	
	A	B	scala	cod	€	cod	€	cod	€	cod	€	cod	€
	6,75	3	200		14.403,00 €		14.403,00 €	4020545	14.799,00 €	1021204	1.340,00 €	1021704	1.378,00 €
	7,75	3	200		15.146,00 €		15.146,00 €	4020546	15.968,00 €	1021205	1.435,00 €	1021705	1.346,00 €
	8,95	4	250/300		16.736,00 €		16.736,00 €	4020547	16.107,00 €	1021206	1.662,00 €	1021706	1.814,00 €
	9,95	4	250/300		17.623,00 €		17.627,00 €	4020548	18.663,00 €	1021207	1.790,00 €	1021707	1.945,00 €

*Prevedere scala Romana da 3,00 h.1,50 / *Provide Roman stair 3,00 h.1,50

SET JAMAICA SERIJE 50 U SASTAVU / KIT COMPLETE OF

- Kompletna struktura čeličnih panela, odgovarajuća bočna pojačanja, pričvrtni nosači.
- Šrafovi za kompletiranje.
- Unutrašnja obloga membrana PVC.
- Aluminijumska vodica za spajanje obloge.
- Mašinska prostorija od fibreglasa spremna za upotrebu, Peščani filter sa 6 položajnim ventilom, monofazna elektropumpa sa predfilterom, povezne cevi, kuglasti ventili i fitting za kompletiranje.
- Set povezanih cevi, fitting i lepak.
- Skimer, na usisu pumpe kompletirana korpicom za otpad, plutajućim poklopcem, priključkom za prelivanje.
- Mlaznice za dovod vode u bazen.
- Električna kutija sa satom za programiranje vremena filtracije pumpe, povežno kablo, spolno kablo sa utičnicom Schuko.
- Structure complete with steel panels, side reinforcements, fixing brackets.
- Bolts made to complete the structure.
- Inner lining in PVC membranwe.
- Aluminium guide for securing the covering.
- Ready to use technical housing in fiberglass, sand filter with six-way valve, single-phase electric pump with pre-filter, connecting pipes, ball valves and fittings.
- Kit of connecting pipes, fittings and glue.
- Skimmer, for pump suction complete with basket to collect impurities, floating wing, connection for overflow.
- Water inlet fittings in the swimming pool.
- Electric panel with clock to program the pump filtration, connecting cable, external cable with Schuko plug.

SERIE 50	Dim u m			Set bazena 1,20 ravno dno		Set bazena 1,20 skok jama		Set bazena 1,50 ravno dno		Bela peskirana ivica		Ivica Rosalind	
	A	B	Sa stepenicama	šifra	€	šifra	€	šifra	€	šifra	€	šifra	€
	6,75	3	200		13.957,00 €		13.957,00 €		14.510,00 €	1021204	1.340,00 €	1021704	1.378,00 €
	7,75	3	200		14.691,00 €		14.691,00 €		15.334,00 €	1021205	1.435,00 €	1021705	1.346,00 €
	9,39	4	250		16.820,00 €		16.820,00 €		17.895,00 €	1021206	1.662,00 €	1021706	1.814,00 €
	10,39	4	250		17.441,00 €		17.441,00 €		18.620,00 €	1021207	1.790,00 €	1021707	1.945,00 €
	11,25	5	300		21.377,00 €		21.377,00 €		22.848,00 €	1021208	1.907,00 €	1021708	2.059,00 €
	11,39	4	250		20.469,00 €		20.469,00 €		21.720,00 €	1021209	1.886,00 €	1021709	2.059,00 €
	12,25	5	300		21.999,00 €		21.999,00 €		23.560,00 €	1021210	2.226,00 €	1021710	2.366,00 €
	13,25	6	300		25.924,00 €		25.924,00 €		27.619,00 €	1021211	2.258,00 €	1021711	2.419,00 €
	14,25	6	300		26.642,00 €		26.642,00 €		28.427,00 €	1021212	2.386,00 €	1021712	2.524,00 €
	15,25	6	300		27.349,00 €		27.349,00 €		29.224,00 €	1021213	2.482,00 €	1021713	2.629,00 €
	17,25	6	300		29.411,00 €		29.411,00 €		31.556,00 €	1021214	2.705,00 €	1021714	2.840,00 €

SET PANELA TWENTY - BAZEN IDRA / JAKE TWENTY PANELS KIT - IDRA / JAKE POOL

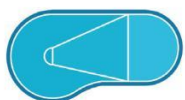

Mod.
IDRA/
JAKE

SET IDRA SERIE 40 U KOMPLETU SA / KIT COMPLETE OF

Struktura kompletna sa čeličnim panelima, odgovarajućim bočnim pojačanjima, pričvrtnim nosačima i šrafovim za kompletiranje. Unutrašnje oblaganje liner di PVC. Filtrirajući zid Ikarus već montiran i spreman za upotrebu, ne zahteva hidraulične intervencije ; sa skimerom, potisnim mlaznicama, filterom, pumpom, fittingom i cevima. Električna tabla sa satom za programiranje, inox čelične stepenice sa 3 protivklizna stepenika.

IDRA KIT SERIES 40 COMPLETE OF

Structure complete with steel panels, side reinforcements, mounting brackets and bolts to complete. Liner in PVC. Filtering wall IKARUS already assembled and ready to operate, requires no plumbing, complete with skimmer, inlets water, filter, pump, pipe for the skimmer, fittings and pipes. Electrical panel with clock programming, stainless steel staircase with three anti-slip steps.

SERIE 40	Dim u m			Set bazena 1,20 ravno dno		Set bazena 1,20 skok jama		Set bazena 1,50 ravno dno		Peskirana bela ivica		Ivica Rosalind	
	A	B	C	cod	€	cod	€	cod	€	cod	€	cod	€
	6,45	3,5	3	4020549	15.564,00 €	4020554	15.564,00 €	4020559	16.605,00 €	1021155	1.285,00 €	1021562	1.826,00 €
7,5	4	3	4020550	16.271,00 €	4020555	16.271,00 €	4020560	17.403,00 €	1021163	1.340,00 €	1021555	1.888,00 €	
8,5	4	3	4020551	16.967,00 €	4020556	16.967,00 €	4020561	18.189,00 €	1021156	1.519,00 €	1021563	1.993,00 €	
9,5	4	3	4020552	17.644,00 €	4020557	17.644,00 €	4020562	18.955,00 €	1021157	1.611,00 €	1021564	2.098,00 €	
10,5	5	4	4020553	20.763,00 €	4020558	20.763,00 €	4020563	22.332,00 €	1021158	1.753,00 €	1021565	2.401,00 €	

KIT JAKE SERIE 50 U SASTAVU / JAKE KIT SERIES 40 COMPLETE OF

- Struktura kompletna sa čeličnim panelima, odgovarajućim bočnim ojačanjima, pričvrtnim nosačima.
- Šrafovi za kompletiranje.
- Unutrašnja obloga PVC membrana.
- Vođica aluminijumska za spajanje obloge.
- Mašinski prostor od fiberglasa spremna za rad, Peščani filter sa 6 položajnim ventilom, monofazna elektropumpa sa prefilterom, cevi za povezivanje, kuglasti ventili i fitting za kompletiranje.
- Set cevi za povezivanje, fitting i lepak.
- Skimer, usisni pri pumpi kompletan sa korpicom za nečistoće, plutajući poklopac, priključak za prelivanje.
- Mlaznice za dovod vode u bazen.
- Električna tabla sa satom za programiranje vremena filtracije pumpe, kablo za povezivanje, spoljno kablo sa utičnicom Schuko.
- Complete structure with steel panels, side reinforcements, mounting brackets.
- Bolts to completion.
- Inner coating in PVC membrane.
- Aluminium guide for hooking coating.
- Technical housing in fiberglass, sand filter with six-way valve, single-phase electric pump with pre-filter, connecting pipes, ball valves and fittings to completion.
- Kit of connecting pipes, fittings and glue.
- Suction skimmer complete of basket, fin floating, overflow attack.
- Inlet fittings water in the pool.
- Electrical panel with clock for time programming filtration pump, connecting cable, external cable with Schuko plug.

SERIE 50	Dim in m			Set bazena 1,20 ravno dno		Set bazena 1,20 skok jama		Set bazena 1,50 ravno dno		Peskirana bela ivica		Ivica Rosalind	
	A	B	C	cod	€	cod	€	cod	€	cod	€	cod	€
	6,25	3,5	3	4020494	14.609,00 €	4020503	15.619,00 €	4020511	16.670,00 €	1021155	1.285,00 €	1021562	1.826,00 €
8,25	4	3	4020495	17.040,00 €	4020504	17.040,00 €	4020512	18.323,00 €	1021156	1.519,00 €	1021563	1.993,00 €	
9,5	4	3	4020496	17.717,00 €	4020505	17.717,00 €	4020513	19.090,00 €	1021157	1.611,00 €	1021564	2.098,00 €	
10,5	5	4	4020497	22.322,00 €	4020506	22.322,00 €	4020514	23.954,00 €	1021158	1.753,00 €	1021565	2.401,00 €	
12	7	5	4020498	23.268,00 €	4020507	25.286,00 €	4020515	28.226,00 €	1021159	2.115,00 €	1021566	2.883,00 €	
13	7	5	4020499	28.733,00 €	4020508	28.733,00 €	4020516	30.797,00 €	1021160	2.243,00 €	1021567	3.015,00 €	
16	9	7	4020501	34.818,00 €	4020509	34.818,00 €	4020517	38.344,00 €	1021161	2.768,00 €	1021568	3.586,00 €	

KONSTRUKCIONI SISTEM OD ČELIČNIH POCINKOVANIH PANELA GALVANIZED STEEL PANEL CONSTRUCTION SYSTEM



Šifra/code	Opis/description Visina/height 120	Cena/price
4020104	Podupirač (2 kom) za panel h 120 + nogar za regulaciju	37,90 €
4020100	Panel Egeo Steel pilastrino h120	24,50 €
4020021	Panel Egeo Steel h 120 L=100 cm	189,30 €
4020702	Panel Egeo Steel h 120 L=100 cm Mlaznica Real	196,30 €
4020704	Panel Egeo Steel h 120 L=100 cm Reflektor mlaznica Real	196,30 €
4020066	Panel Egeo Steel h 120 L=100 cm Skimer LX7 / Senior	196,30 €
4020022	Panel Egeo Steel h 120 L=135 cm	265,90 €
4020023	Panel Egeo Steel h 120 L=150 cm	248,10 €
4020024	Panel Egeo Steel h 120 L=200 cm	315,60 €
4020708	Panel Egeo Steel h 120 L=200 cm Mlaznica Real	322,50 €
4020710	Panel Egeo Steel h 120 L=200 cm reflektor mlaznica Real	322,50 €
4020096	Panel Egeo Steel h 120 L=200 cm Skimer LX7 / Senior	322,50 €
4020020	Panel Egeo Steel h 120 L=50 cm	114,40 €
4020198	Panel Egeo Steel h 120 L=50x50 pregib 270°	263,70 €
	Visina/height 135	
4020739	Podupirač (2 kom) per panel h 135 + nogar za regulaciju	39,80 €
4020738	Panel Egeo Steel pilastrino h135	26,80 €
4020718	Panel Egeo Steel h 135 L=100 cm	220,20 €
4020748	Panel Egeo Steel h 135 L=100 cm Mlaznica Real	227,20 €
4020750	Panel Egeo Steel h 135 L=100 cm Reflektor mlaznica Real	227,20 €
4020725	Panel Egeo Steel h 135 L=100 cm Skimer LX7 / Senior	227,20 €
4020719	Panel Egeo Steel h 135 L=150 cm	250,90 €
4020720	Panel Egeo Steel h 135 L=200 cm	321,10 €
4020754	Panel Egeo Steel h 135 L=200 cm Mlaznica Real	328,10 €
4020756	Panel Egeo Steel h 135 L=200 cm Reflektor mlaznica Real	328,10 €
4020735	Panel Egeo Steel h 135 L=200 cm Skimer LX7 / Senior	328,10 €
4020716	Panel Egeo Steel h 135 L=50 cm	134,90 €
4020745	Panel Egeo Steel h 135 L=50x50 pregib 270°	294,60 €
	Visina/height 150	
4020105	Podupirač (2 kom) per panel h 150 + nogar za regulaciju	39,80 €
4020041	Pannel Egeo Steel h 150 L=100 cm	220,20 €
4020712	Panel Egeo Steel h 150 L=100 cm Mlaznica Real	227,20 €
4020714	Panel Egeo Steel h 150 L=100 cm reflektor mlaznica Real	227,20 €
4020131	Panel Egeo Steel h 150 L=100 cm Skimer LX7 / Senior	227,20 €
4020042	Panel Egeo Steel h 150 L=135 cm	296,10 €
4020040	Panel Egeo Steel h 150 L=50 cm	134,90 €
4020199	Panel Egeo Steel h 150 L=50x50 pregib 270°	294,60 €
4020101	Panel Egeo Steel stubić h150	26,80 €
4020102	Panel Egeo Steel zakrivljen širok 1 m do h 150	425,00 €
	Accessori/accessories	
4020110	Vijci Ø12x30 + Navrtka M12 + Podloške M12	0,90 €
4020108	Kočiči za ankerisanje	2,80 €

**PANELI SAMONOSEĆI EGEO STEEL
SELF-SUPPORTING PANELS EGEO STEEL**

Šifra/code	Opis/description	cena/price
4020019	Panel Egeo Steel Samonoseći zakrivljen 1 m fino a h 150	315,60 €
4020011	Pannelo Egeo Steel Samonoseći h 120 L=100 cm	189,30 €
4020010	Pannel Egeo Steel Samonoseći h 120 L=50 cm	114,40 €
4020008	Pannel Egeo Steel Samonoseći h 135 L=100 cm	372,80 €
4020007	Pannel Egeo Steel Samonoseći h 135 L=50 cm	222,20 €
4020017	Pannel Egeo Steel Samonoseći h 150 L=100 cm	248,10 €
4020016	Pannel Egeo Steel Samonoseći h 150 L=50 cm	265,90 €
4020405	Pocinkovana spona za nadzemne bazene do h 150	134,90 €
OPREMA/ACCESSORIES		
4020112	VijciØ12x60 + Navrtka M12 + Podloške M12	1,05 €
4020108	Kočiči za ankerisanje	2,80 €

**PRELIVNA IVICA EGEO STEEL
OVERFLOW EDGE EGEO STEEL**

Šifra/code	Opis/description	cena/price
4030290	Ugao 270° za prelivnu ivicu	223,80 €
4030289	Ugao 90° za prelivnu ivicu	223,80 €
4030101	Spojni ugao za prelivnu ivicu	8,10 €
4030106	Prelivna ivica	81,50 €
4030108	Prelivna ivica sa odvodom	81,50 €
4030109	Prelivna preformirana ivica	121,10 €
4030112	Prelivna preformirana ivica sa odvodom	121,10 €
4030107	Potporni ugao prelivne ivice	12,90 €

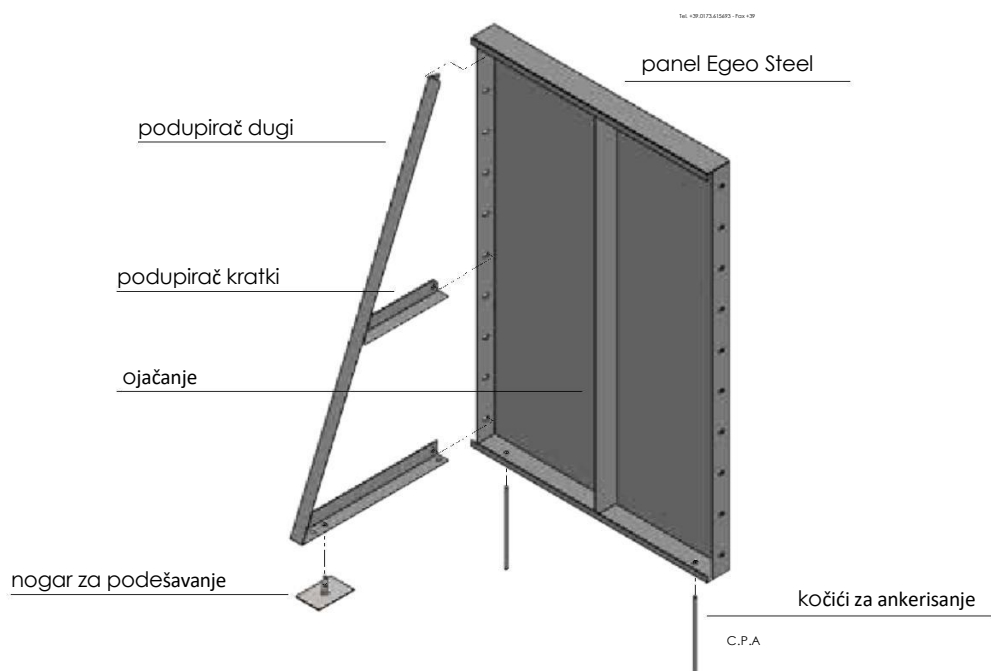

GARDEN



Bazen od fiberglasa idealan za male prostore ili unutrašnje.

Isporučuje se u kompletu sa mašinskim prostorom MAC 6 sa:

- 1 pumpa filtraciona 0,37 kW monofazna
- 1 peščani filter
- 1 komandna tabla sa planiranjem vremena filtracije
- 1 skimer, 2 potisne mlaznice, 1 lampa led beli.
- Set za protivstrujno plivanje za verziju PRESTIGE

Fiberglass pool ideal for small spaces or indoors. It is supplied complete with technical housing MAC 6 with:

- 1 filtration pump 0,37 kW mono-phase
- 1 sand filter
- 1 control panel with planning filtration slots
- 1 skimmer, 2 return fitting, 1 led white projector
- swimming against current KIT for PRESTIGE VERSION



Rasveta led
led lighting



protivstrujno plivanje
(ver. PRESTIGE)
counter-current swimming
(PRESTIGE ver.)

DIMENZIJE / DIMENSIONS:

- Unutrašnja dužina: 4,66 m
- Unutrašnja širina: 2,10 m
- Spoljna dužina: 5,04 m
- Spoljna širina: 2,40 m
- Visina: 1,39 m
- Internal length: 4,66 m
- Internal width: 2,10 m
- External length: 5,04 m
- External width: 2,40 m
- Height: 1,39 m

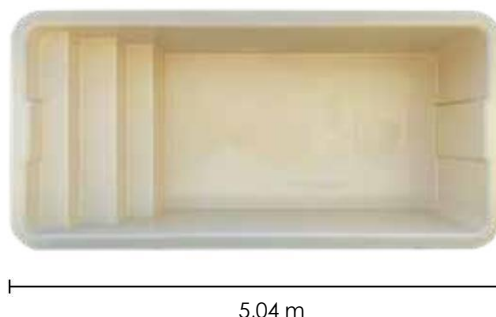

BOJE / COLOURS

- Siva Grey
- Pesak Sand
- Bela White
- Svetlo plava Light blue

Šifra / code	Opis /description	Cena / price
8200141	Garden – ne opremljena / Garden - not equipped	10.095,00 €
8200142	Garden standard (kompletna maš.prostorija, skimer, mlaznice, lampa)	12.080,00 €
8200143	Garden prestige (kompletna) / Garden prestige (full optional)	14.700,00 €
OPCIJA / OPTIONS		
8200125	Set ravnih ivica Espace boje pesak / Espace flat edges kit sand colour	1.143,00 €
8200126	Set ravnih ivica Espace sive boje / Espace flat edges kit grey colour	1.143,00 €
8200145	Izotermička prekrivka sa mehurima / Bubble cover	212,50 €
8200146	Zimska prekrivka sa perimetralnim ušicama I elastičnim kanapom / Winter cover with perimeter eyelets and elastic cord	194,70 €

LIBERTY SPA



Liberty SPA savršeno prilagodljiv malim prostorima. Njegove kompaktne dimenzije olakšavaju njegovu integraciju i instalaciju kako u otvorenim tako i zatvorenim prostorima, zadržavajući prednosti tradicionalnog bazena. Liberty SPA je koncentrat tehnologije, opremljen za vaše ugodno osećanje sa:

- Protivstrujnim plivanjem
- 2 hidromasažna sedišta
- 2 hidromasažne ležaljke
- Automatski sistem grejanja
- Nominalne dimenzije: 2,28 x 4,94 x 1,34 m

Liberty SPA perfectly adapts to small spaces. Its compact dimensions facilitate its integration and installation outside as inside, while maintaining the advantages of a traditional swimming pool. Liberty SPA is a combination of technology, equipped for your well-being with:

- Counter-current swimming
- 2 hydromassage seats
- 2 hydromassage chaise longue
- Automated heating system
- Nominal size: 2,28 x 4,94 x 1,34 m



sedišta
seats



ležaljka
lounger

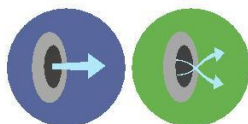

mlazevi vode
water jets



mlaznice
air jets



protivstrujno plivanje
counter-current swimming

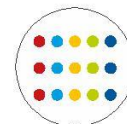

rasveta led
led lighting



Slike služe samo u ilustrativne svrhe
The images have illustration purpose only

Šifra/ Code	Opis/Descrizione	Cena/Price
8200151	Liberty SPA prestige - Kompletna (vd. Tabelu opreme) / Full optional (see equipment table)	30.440,00 €
8200254	Liberty SPA sa oblogama / Liberty SPA with panelling	33.090,00 €
OPZIONI / options		
8200193	Tvrda prekrivka SPA Liberty / Hard cover SPA Liberty	1.200,00 €

OPREMA / EQUIPMENT	
HIDROMASAŽA-PROTIVSTRUJNO PLIVANJE / HYDROMASSAGE COUNTER-CURRENT SWIMMING	
2 Hidromasažna sedišta / 2 hydromassage seats 2 Ležaljke vazdušne masaže / 2 air massage loungers	
2 Hidromasažne pumpe 2 cv 2 hydromassage pumps 2 cv	
1 pumpa NCC 3 cv, 40 m³/h 1 counter-current pump 3 cv, 40 m³/h	
1 kompresor 0,9 kW 1 vazdušnamasaža blower 0,9 kW air massage	
FILTRACIJA / FILTRATION	
1 skimer, 2 mlaznice / 1 skimmer, 2 return fittings	
1 mašinska prostorija / 1 technical housing	
1 filtraciona pumpa / 1 filtration pump	
1 Ketrđž filter / 1 cartridge filter	
1 Komandna tabla sa planiranjem vremenske filtracije sa električnim grejačem 1 control panel with planning filtration slots with electrical heater	
1 Komandna tabla / 1 control panel	
OPREMA/ ACCESSORIES	
1 Projektor LED / 1 LED projector	
POTROŠNJA / power consumption	
Napajanje monofazno ili trofazno po zahtevu / Single-phase or three-phase power on request	
Filtracija i grejanje [kW] Filtration and heating	4,1
Hidromasaža / Hydromassage [kW]	6,2
Max [kW]	6,2

BOJE / COLOURS

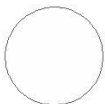

Belo
White



Tvrdi poklopac SPA Liberty
Hard cover for SPA Liberty
code 8200193



MINI BAZEN TIRRENA / MINI POOL TIRRENA

NEW



Male dimenzije čine TIRRENA najboljim rešenjem za male Unutrašnje prostore i spoljne manje prostore. Zahvaljujući svojoj posebnoj završnoj obradi, omogućava Intimnu i opuštajuću atmosferu. To je model koji najbolje omogućava personalna rešenja i u estetskom smislu. Standardna isporuke uključuje noseću strukturu, preformirani ram, skimer, oblogu dna e i obodne ivične jastuke.

Urađene standardne rupe za opremu koja se koristi.

Its small size makes TIRRENA the best solution for small indoor spaces and outdoor areas. Thanks to its special finishes, it is able to give an intimate and relaxing atmosphere. It is the model that best lends itself to customizations, including aesthetic ones. Standard supply includes the supporting structure, pre-assembled frame, skimmer, bottom infill and perimeter edge cushions. Standard drilling included for accessories used.

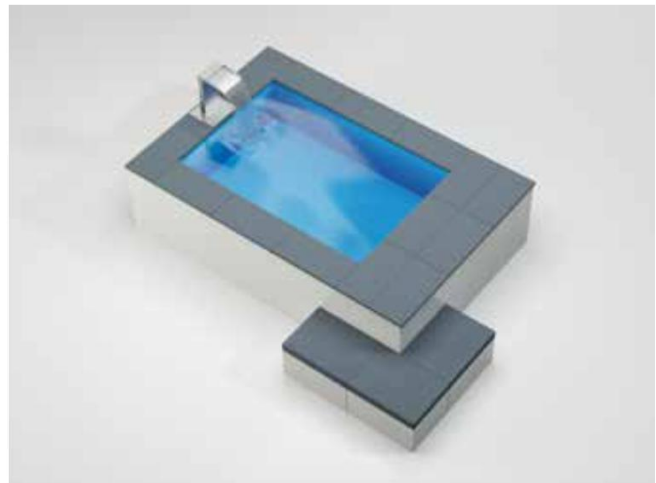

STRUKTURA / STRUCTURE

Struktura se sastoji od stubova, perimetralnog oblaganja dna, ploča za podešavanje, skimmer, unutrašnjih panela, korišćeni materijal je strukturalni čelik S280 vruće pocinčani Z275 i obostrano plastificiran konstrukcijski čelik, obrađen laserskim rezanjem i savijanjem.

The structure consists of footings, perimeter bottom plugging, adjustment plates, skimmers, internal panels, the material used is Z275 hot-dip galvanized S280 structural steel and bi-plasticized, processed by laser cutting and bending.

TEHNIČKI PODACI / TECHNICAL DATA

Nivo vode/ Water height: 70 cm
Spoljna visina sa ramom/ External height with frame: 100 cm
Modularnost unutrašnjih panela/ Modularity of interior panels: da 80cm
Otisak podne konstrukcije plus 80 cm/ Floor structure footprint

JASTUCI PERIMETRALNOG OBODA/ PERIMETER EDGE PILLOWS



Vodootporni jastuci od sunđera spolja presvučeni nautičkom kožom

Boje na raspolaganju:
Royal Plava i tamno siva.



Royal Blue



Dark Grey

SPOLJNE PRESVLAKE I OPREMA/ EXTERIOR COVERINGS AND ACCESSORIES

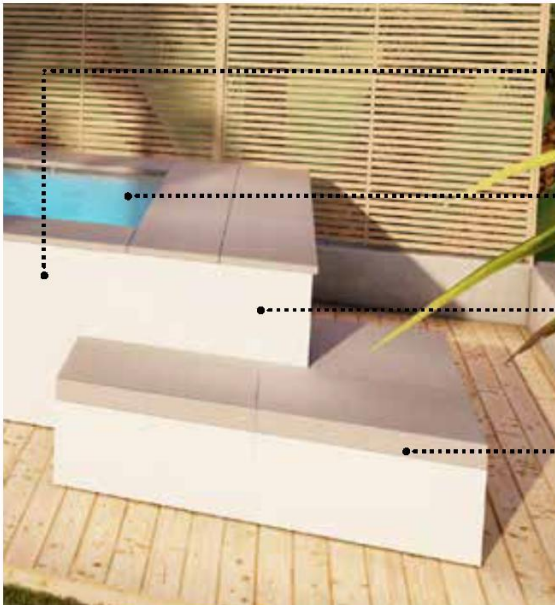

Ploče od pocinčanog čelika sa tri vrste finiša: plastificirane, pocinkovane, pocinkovano farbane. Boje farbe potražite u tabeli RAL.

Unutrašnja klupa u standardnom formatu ili po meri na zahtev kupca.

Prostor sa jastucima

Pouf sa podesivim jastukom

DIMENZIJE NA RASPOLAGANJU/ AVAILABLE DIMENSIONS



Šifra code	Spoljne dimenzije External dimensions [m]		Unutrašnje dimenzije Internal dimensions [m]			Oprema Equipment
	A	B	A	B	Visina Height [m]	Rupa Lampe [n°]
4030518	3,2	4	2,4	3,2	0,8	1
4030519	3,2	4,8	2,4	4	0,8	1
4030520	3,2	5,6	2,4	4,8	0,8	1
4030521	3,2	6,4	2,4	5,6	0,8	1
4030522	4	4	3,2	3,2	0,8	1
4030523	4	4,8	3,2	4	0,8	1
4030524	4	5,6	3,2	4,8	0,8	1
4030525	4	6,4	3,2	5,6	0,8	1

Cena po upitu - prices on request

NEZAVISNI BAZEN MEDITERRANEA INDEPENDENT MEDITERRANEA POOL



MEDITERRANEA JE NEZAVISNI BAZEN KOJI:

- Zahvaljujući svojoj modularnoj strukturi omogućava instalaciju koja odgovara svakoj vrsti zemljišta.
- Realizovana modularnim sistemom pocinkovanih čeličnih panela ; ima unapred zavarenu PVC oblogu koji garantuje trajanje u godinama i savršeni estetski fini.
- Posедуje kompletni mašinski prostor unapred opremljen, pozicioniran pri uzglavlju bazena
- Moguće je opremiti je sa kompletom za protivstrujno plivanje, rasvetnim sistemom LED RGB
- U isporuci kompleta Mediterranea ivice nisu uključene

MEDITERRANEA the new INDEPENDENT pool that:

- thanks to its structure allows an easy installation on all types of ground, without structural work
- it's made with a modular galvanized steel panels system and a PVC coating welded in place that guarantees the duration and a perfect aesthetic finish
- it is equipped with a complete and pre-equipped technical room positioned in the head of the pool
- it can be equipped with counter-current swimming kit and LED RGB lighting system
- in the supply of the Mediterranean kit the edges are excluded



NEZAVISTAN
INDEPENDENT



BEZ STRUKTURALNIHRADOVA



LAKO SE MONTIRA
EASY TO INSTALL

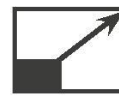

POGODAN ZA SVAKO ZEMLJIŠTE
EASY TO FIX ON EVERY GROUND



LIČNO OBELEŽJE
CUSTOMIZABLE

SET ISPORUČEN U KOMPLETU SA OPREMOM, PRIBOROM I ELEKTRIČNOM TABLOM COMPLETE KIT WITH POOL EQUIPMENT, ACCESSORIES AND ELECTRICAL PANEL



Set isporučen u kompletu sa opremom, priborom i električnom tablom

Ovaj bazen je presvučen s polja toplo farbanim limom: Otporan je na bilo kakvu spoljnu agresiju: onih prorodnih kao što su insekti, termiti, gljivice i drugi mikroorganizmi, kiša, grad, sneg UV zraci. Basen zahvaljujući pre zavarenoj oblozi u PVCimun je na razredene kiseline i sone i hlorne rastvore. Nema potrebu za održavanjem tokom vremena.

Complete Kit with pool equipment, accessories and electrical panel.

This pool has an external coating in hot-painted sheet. It's absolutely immune to any type of external aggression: from natural ones such as insects, termites, fungi and other microorganisms, rain, hail, snow and UV rays. The basin, thanks to the pre-welded PVC coating, is immune to diluted acids and saline or chlorinated solutions. It does not need maintenance over time.

BOJE LINER / LINERS COLOURS



Svetlo plava
light blue

pesak
sand

plavo
blue

belo
white

sivo
grey

antracite
anthracite

BOJE BOČNIH PANELA / SIDE PANELS COLOURS



Belo 9010 - SET STANDARD
White - STANDARD KIT

RAVNI REFLEKTOR / FLAT PROJECTOR

Na upit
on request



Šrafi se na mlaznicu. Telo projektor realizovano od polikarbonata i ABS sa velikom otpornošću na udar, toplotu i hemijsku agresiju proizvoda za tretman vode.

To be screwed on a return fitting. Projector-body made of polycarbonate and ABS with high resistance to shock, heat and chemical attack of water treatment products.



Cod. 1070229



Cod. 1070227



Cod. 1070228



Cod. 1070226



Cod. 1070211

Na upit
on request

STEPENICE

Cod. 1025100 - scala Duple stepenice
Cod. 1025100 - Double ladder



Proizvedene od čeličnih cevi
inox 304 - prečnik Ø 43 mm.
Made with tube Ø 43 mm in stainless
steel 304.

DIMENZIJE NA RASPOLAGANJU



Unutrašnje dimenzije Internal dimensions [m]		Spoljne dimenzije External dimensions [m]			Oprema Equipment			
A	B	A	B	Visina Height [m]	Lampa Lamp [n°]	Peščani filter Sand Filter [mm]	Pumpa Pump [hp]	Obloge Membrane
3	3	3,60	4,10	1,25	1	Ø 500	0,5	Liner
3	4,5	3,60	5,60	1,25	1	Ø 500	0,5	Liner
3	6	3,60	7,10	1,25	1	Ø 500	0,5	Liner
3	7,5	3,60	8,60	1,25	1	Ø 500	0,5	Liner
3	9	3,60	10,10	1,25	1	Ø 500	0,5	Liner
3	10,50	3,60	11,60	1,25	1	Ø 500	0,5	Liner
4	3	4,60	4,10	1,25	1	Ø 500	0,5	Liner
4	4,5	4,60	5,60	1,25	1	Ø 500	0,5	Liner
4	6	4,60	7,10	1,25	1	Ø 500	0,5	Liner
4	7,5	4,60	8,60	1,25	1	Ø 500	0,5	Liner
4	9	4,60	10,10	1,25	1	Ø 500	0,5	Liner
4	10,50	4,60	11,60	1,25	1	Ø 500	0,5	Liner

Za cenu bazena Mediterranea uzeti u obzir namenski cenovnik
For the Mediterranea quotation please refer to the dedicated price list

BAZEN ADRIATICA PRELIVNI/ADRIATICA OVERFLOW POOL

NEW

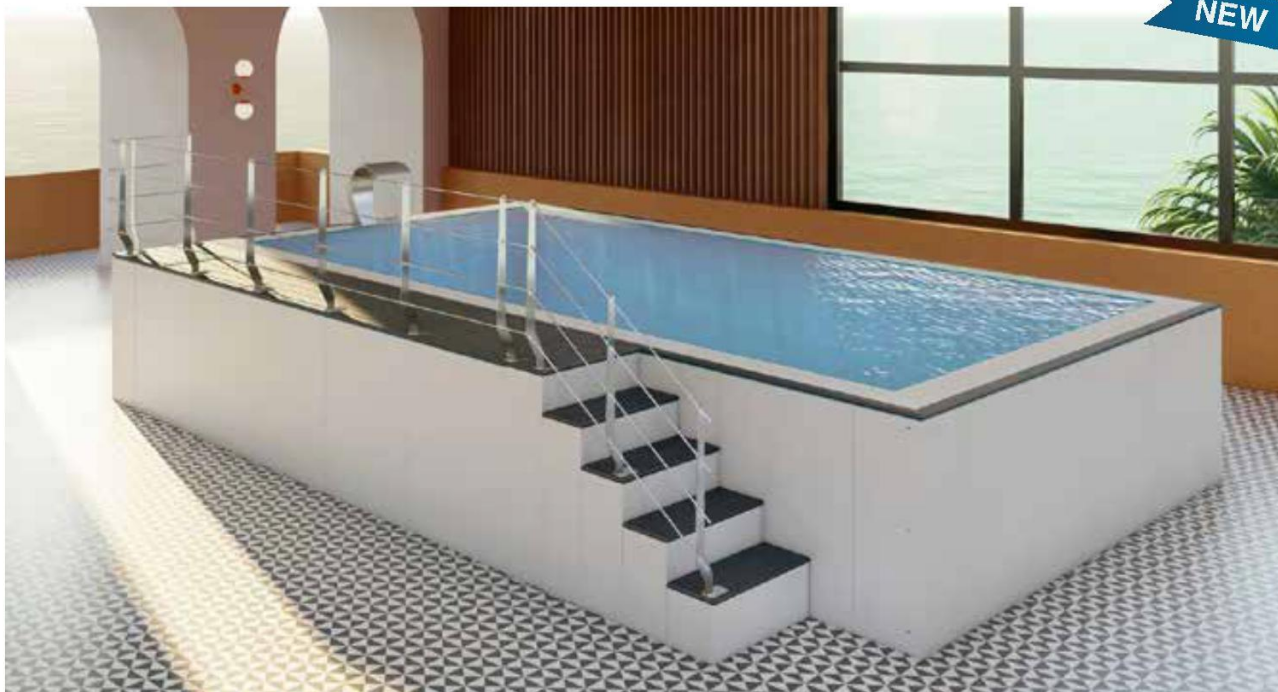

ADRIATICA je neuporedivo nadzemno rešenje prelivnih ivica sa modularnom, samonosivom metalnom konstrukcijom. Čiste linije lično obeležje zahvaljujući raznoj opremi, **ADRIATICA se može** postaviti o bilo kojem kontekstu bez pribegavanju ovlašćenjima i strukturalnim radovima, drastično smanjujući vreme i troškove realizacije. Unapred montirani ram, dostupan kao opcija, omogućava ugradnju bazena direktno na neravnom terenu i ne zahteva nikakvu vrstu betonske ploče. Kompenzacioni rezervoar integrisan direktno u konstrukciju, nema potrebu za spoljnom tehničkom prostorijom, optimizirajući vreme ugradnje i osiguravajući bolje korišćenje prostora uz bazen. Standardni Prorezi se podrazumevaju za korišćenu opremu.

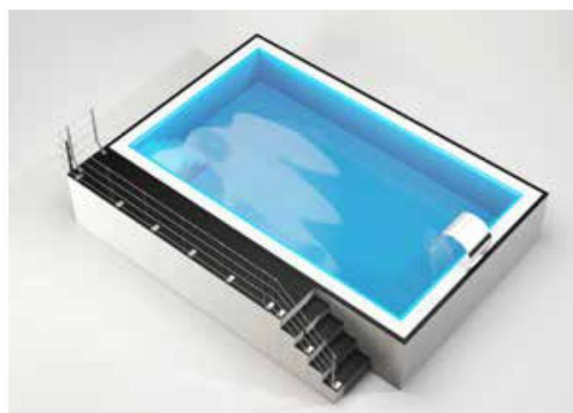

ADRIATICA is the unparalleled overflow edge above-ground solution with a modular, self-supporting metal structure. Clean lines, customizations thanks to a variety of accessories, ADRIATICA can be placed in any context without the need for permits and construction work, drastically reducing the time and cost of implementation.

The pre-assembled frame, available additionally, allows the pool to be installed directly on uneven terrain and does not require any type of concrete slab. The compensation tank integrated directly into the structure avoids the need for an external technical room, optimizing installation time and ensuring better use of space adjacent to the pool. Standard borings included for accessories used.



Prelivna ivica
Blowing edge



Pogodna za sve terene
Easy to fix on every ground



Brza montaža
Fast assembly

TEHNIČKI PODACI / TECHNICAL DATA

Nivo vode 120 cm / Water height: 120cm
Spoljna visina bez rama 127 cm/ External height without frame: 127cm
Spoljna visina sa ramom 137 cm/ External height with frame: 137cm
Modularnost unutrašnjih panela od 90 cm/ Modularity of interior panels: da 90cm
Gabarit podne strukture plus 80 cm/ Floor structure footprint: più 80cm

STRUKTURA / STRUCTURE

Struktura se sastoji od zidova, perimetralnih obloga dna, ploča za podešavanje, unutrašnjih panela. Korišćeni materijal je konstrukcijski čelik S280 presvučen Magnelisom i farban prahom obrađen laserskim rezanjem i savijanjem.

The structure consists of posts, bottom perimeter infill, adjustment plates, and interior panels. The material used is structural steel S280 coated with Magnelis and powder coated, processed by laser cutting and bending.

Ploča za podešavanje kanala
Channel adjustment plate
Zid
Upright
Podešavajuće ploče
Adjustment plates

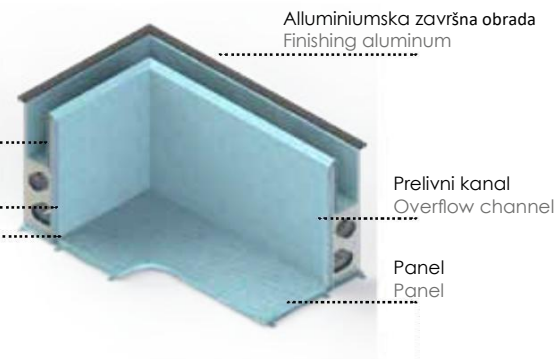

Pocinkovane

čelične ploče sa 3 vrste završne obrade: plastificirano, pocinkovano, obojeno pocinkovano. Boje farbe potražite u RAL tabeli

Dizajn parapeta od čelika inox uparići sa stepenicama sa stazom. Pozicija rukohvata (desna ili leva) zavisi od pozicioniranja stepenica.

Spoljne stepenice od pocinkovanog čelika, koriste oblogu bazena i opremljene su gornjom WPC završnom obradom. Unutrašnji prostor staze može se koristiti kao tehnički prostor.

DIMENZIJE NA RASPOLAGANJE / AVAILABLE DIMENSIONS



Šifra code	Spoljne dimenzije External dimensions [m]		Unutrašnje dimenzije Internal dimensions [m]			Oprema Equipment
	A	B	A	B	Visina Height [m]	Lampa Lamp [n°]
4030500	3,5	5,3	2,7	4,5	1,2	1
4030501	3,5	6,2	2,7	5,4	1,2	1
4030502	3,5	8	2,7	7,2	1,2	1
4030503	3,5	8,9	2,7	8,1	1,2	1
4030504	3,5	9,8	2,7	9	1,2	1
4030505	3,5	11,6	2,7	10,8	1,2	1
4030506	4,4	5,3	3,6	4,5	1,2	1
4030507	4,4	6,2	3,6	5,4	1,2	1
4030508	4,4	8	3,6	7,2	1,2	1
4030509	4,4	8,9	3,6	8,1	1,2	1
4030510	4,4	9,8	3,6	9	1,2	1
4030511	4,4	11,6	3,6	10,8	1,2	1
4030512	5,3	5,3	4,5	4,5	1,2	1
4030513	5,3	6,2	4,5	5,4	1,2	1
4030514	5,3	8	4,5	7,2	1,2	1
4030515	5,3	8,9	4,5	8,1	1,2	1
4030516	5,3	9,8	4,5	9	1,2	1
4030517	5,3	11,6	4,5	10,8	1,2	1

Cene po upitu - prices on request

PRELIVNA IVICA STANDARD / STANDARD OVERFLOW EDGE



Šifra/ Code	Opis/Descrizione	Cena/ Price
1020590	Prelivna ivica prava sekcija / Overflow edge straight section	111,70 €
1020591	Prelivna ivica prava sekcija sa odvodom Ø100 / Overflow edge straight section with drain	214,20 €
1020685	Prelivna ivica prava sekcija sa terminalom / Overflow edge straight section with terminal	153,80 €
1020592	Prelivna ivica sekcija sa pravim uglom / Overflow edge section	182,30 €
1020593	Prelivna ivica pravi obrnuti ugao / Overflow edge section 90° backhand	222,80 €

Prelivna ivica **radijus sekcija/overflow edge radius section:**

Opis/Descrizione								Cena/ Price
Prelivna ivica sekcija radijus / Overflow edge radius section								153,80 €
Šifra	1020610	1020611	1020612	1020613	1020614	1020615	1020686	1020697
Radijus	1,50	2,00	2,50	3,00	4,00	5,00	6,00	7,00



Opis/Descrizione								Cena/ Price
Prelivna ivica radijus sekcija sa odvodom / Overflow edge radius section with drain								254,10 €
Šifra	1020618	1020619	1020620	1020621	1020622	1020623	1020687	1020698
Radijus	1,50	2,00	2,50	3,00	4,00	5,00	6,00	7,00

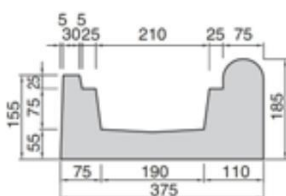

Opis		Cena/ Price
Prelivna ivica sekcija obrnuti radijus / Overflow edge radius section backhand		153,80 €
Šifra	1020688	1020689
Radijus	1,00	3,50

FINSKA PRELIVNA IVICA / FINNISH OVERFLOW EDGE

Za optimalni preliv obavezno zaravnati gornji deo
For an optimal overflow it is mandatory to shave the top



Šifra/ Code	Opis	Cena/ Price
1020597	Prelivna finska ivica prava sekcija / Finnish overflow edge straight section	169,40 €
1020598	Finska prelivna ivica prava sekcija sa odvodom Ø100 / Straight section with drain	249,80 €
1021610	Finska prelivna ivica prava sekcija sa terminalom/Finnish overflow edge straight section with terminal	189,00 €
1020599	Finska prelivna ivica sekcione pravi ugao / Edge section 90°	217,60 €
1020562	Finska prelivna ivica sekcija obrnuti pravi ugao / Section 90° backhand	257,80 €

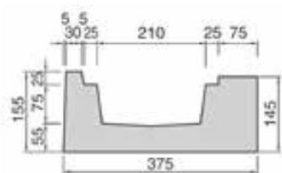

Opis								Cena/ Price
Finska prelivna ivica sekcija radijus / Radius section								209,00 €
Šifra	1020632	1020633	1020634	1020635	1020636	1020637	1020703	1020702
Radijus	1,50	2,00	2,50	3,00	4,00	5,00	6,00	7,00

Opis/Descrizione								Cena/ Price
Finska prelivna ivica radijus sekcija sa odvodom / Radius section with drain								289,70 €
Šifra	1020640	1020641	1020642	1020643	1020644	1020645	1020704	1020705
Radijus	1,50	2,00	2,50	3,00	4,00	5,00	6,00	7,00

Opis/Descrizione		Cena/ Price
Finska prelivna ivica sekcija obrnuti radijus / Radius section backhand		209,00 €
Codice	1020741	1020742
Radijus	1,00	3,50

**PRELIVNA IVICA PLAŽA
BEACH OVERFLOW EDGE**

Aglomerat betonskog granulata širine 38 cm, dužine 50 cm, visina 16 cm.
In agglomerated cement grit width 38 cm, length 50 cm, height 16 cm.

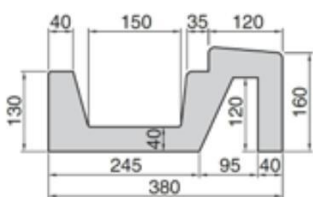

Šifra/ Code	Opis/Descrizione	Cena/ Price
1020743	Prelivna ivica Spiaggia prava sekcija Beach overflow edge straight section	105,00 €
1020744	Prelivna ivica Spiaggia prava sekcija sa odovodom Beach overflow edge straight section with drain	148,50 €
1020745	Prelivna ivica Spiaggia prava sekcija sa terminalom Beach overflow edge straight section with terminal	144,90 €
1020746	Prelivna ivica Spiaggia sekcija pravi ugao Beach overflow edge section 90°	217,30 €
1020747	Prelivna ivica Spiaggia sekcija obrnuti pravi ugao Beach overflow edge section 90° backhand	217,30 €
1020748	Prelivna ivica Spiaggia sekcija obrnuti radijus sekcija / Beach overflow edge section radius / backhand radius	241,20 €
1020749	Prelivna ivica Spiaggia sekcija radijus sa odovodom/ Beach overflow edge section radius / backhand radius w/drain	283,00 €

REŠETKA MASTER - PRAVA I ZAKRIVLJENA / MASTER GRID - STRAIGHT AND CURVED



Šifra/ code	Opis/description	Cena/ price
1065200	rešetka Master prava od polipropilena šir.247,5 mm -sp 25 mm Straight grid in PP width 247.5 mm -sp 25 mm al m	51,20 €
1065201	Rešetka Master zakrivljena od polipropilena šir.247,5 mm -sp 25 mm Curved grid in PP width 247.5 mm -sp 25 mm al m	51,20 €

REŠETKA ABS ZAKRIVLJENA / CURVED GRID IN ABS



Šifra/ Code	Opis	Cena/ Price
1065238	Rešetka ABS zakrivljena širina 245 mm - sp 30 mm Grid in ABS curved po m	53,60 €
1065240	Rešetka ABS zakrivljena širina 295 mm - sp 30 mm Grid in ABS curved al m	64,40 €

REŠETKA OD POLIPROPILENA ZAKRIVLJENA

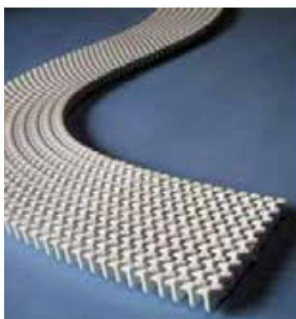

Cod.1065312-1065313-1065314-1065315



Cod. 1065317

Poštujte standarde UNI EN 13451-1 (8 mm) / La GR47
MOže se uraditi u boji po zahtevu: minimalna količina
50 m, uvećanje cene 20%, termin isporuke
30 dana.

Complies the UNI EN 13451-1 (8mm) rules GR47 one can
be colored on request: minimum quantity 50 meters,
20% price increase, delivery time 30 days.

Šifra/code	Opis/description		Cena/price
1065312	Zakrivljena rešetka GR47 od polipropilena šir. 180 mm - sp 25 mm Curved grid in PP	po m	59,10 €
1065313	Zakrivljena rešetka GR47 od polipropilena šir. 200 mm - debljina 25 mm Curved grid in PP	po m	66,70 €
1065317	Zakrivljena rešetka GR90 od polipropilena šir. 245 mm - debljina 22 mm Curved grid in PP	po m	77,60 €
1065314	Zakrivljena rešetka GR47 polipropilen šir. 250 mm - debljina 25 mm Curved grid in PP	po m	77,60 €
1065315	Zakrivlj. rešetka GR47 od polipropilena šir. 300 mm - debljina 25 mm Curved grid in PP	po m	102,30 €

PEŠKIRANA REŠETKA / SANDBLASTED GRID



Za ispravno polaganje i korišćenje neophodno je tretirati impregniranim
zaštitnim tretmanom

Šifra BELS/ code WHITE	Šifra ŽUTA/code YELLOW	Opis/description	Cena Belo/ price WHITE	Cena žuta/price YELLOW
1020045	1020552	Peskirana rešetka 50x24,9 cm* / Blast grid 50 cm*	82,90 €	85,30 €
1020043	1020566	Ugaona peskirana rešetka* / Blast edge grid*	165,70 €	171,30 €
1020569	1020567	Radiusna peskirana rešetka* / Blast radius grid*	165,70 €	171,30 €

*Pri narudžbi specificirati traženi model: A, B o C

*Specify the required model when ordering: A, B or C

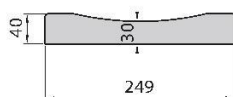

A – prelivni plaža
A - beach overflow
± Kg 9,00

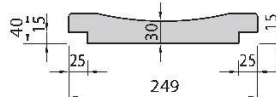

B – prelivni standard/visoki
B - standard overflow/high
± Kg 8,50

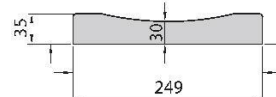

C – srednji preliv
C - medium overflow
± Kg 9,00

UGAONE PLOČE ZA REŠETKE / CORNER PLATES FOR GRID

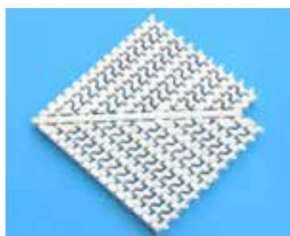

Šifra/ code	Opis/description	Cena/ price al pz
1065320	Ugaona ploča 90° širina 195 mm – sp 22 mm / Angle 90°	53,60 €
1065206	Ugaona ploča 90° širina 245 mm – sp 22 mm / Angle 90°	66,00 €
1065322	Ugaona ploča 90° širina 295 mm – sp 22 mm / Angle 90°	84,30 €
1065338	Ugaona ploča 90° širina 195 mm – sp 35 mm / Angle 90°	53,00 €
1065241	Ugaona ploča 90° širina 245 mm – sp 35 mm / Angle 90°	67,50 €
1065243	Ugaona ploča 90° širina 295 mm – sp 35 mm / Angle 90°	82,00 €
1065340	Ugaona ploča 90° širina 335 mm – sp 35 mm / Angle 90°	98,40 €
1065330	Ugaona ploča 45° širina 195 mm – sp 22 mm / Angle 45°	42,20 €
1065209	Ugaona ploča 45° širina 245 mm – sp 22 mm / Angle 45°	49,50 €
1065332	Ugaona ploča 45° širina 295 mm – sp 22 mm / Angle 45°	59,10 €
1065339	Ugaona ploča 45° širina 195 mm – sp 35 mm / Angle 45°	41,70 €
1065333	Ugaona ploča 45° širina 245 mm – sp 35 mm / Angle 45°	48,40 €
1065334	Ugaona ploča 45° širina 295 mm – sp 35 mm / Angle 45°	55,90 €
1065335	Ugaona ploča 45° širina 335 mm – sp 35 mm / Angle 45°	66,90 €

UGAONE PLOČE ZA REŠETKU FS47 E FS90
CORNER PLATES FOR FS47, FS90 GRID

Cod. 1065318 - 1065319 - 1065311

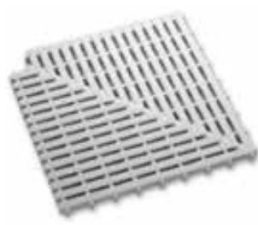

Cod. 1065236

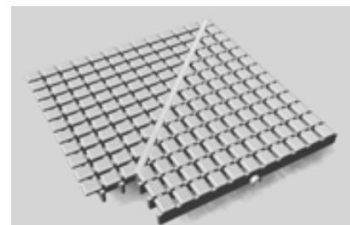

Cod. 1065316

Šifra/code	Opis/description	Cena/price al pz
1065318	Rešetkasta ugaona ploča GR47 da 18 cm - sp 25 mm / Angle 90° for grid GR47 18 cm	66,50 €
1065319	Rešetkasta ugaona ploča GR47 da 20,5 cm - sp 25 mm / Angle 90° for grid GR47 20,5 cm	73,50 €
1065311	Rešetkasta ugaona ploča GR47 da 25 cm - sp 25 mm / Angle 90° for grid GR47 25 cm	84,00 €
1065236	Ugaona ploča 90° da 261 mm a 370 mm - sp 25 mm	91,50 €
1065316	Ugaona ploča 90° GR90 da 24,5 cm - sp 22 mm / Angle 90° for grid GR90 24,5 cm	84,00 €

*Odgovara rešetki FS47 širina 300 mm / *Suitable for FS47 grid width 300 mm



KOMPENZACIONI REZERVOAR I OPREMA / OVERFLOW TANKS AND ACCESSORIES



KOMPENZACIONI REZERVOAR
ATLANTIC
dim. 2,36x2,46x1,60h m



KOMPENZACIONI REZERVOAR
GLOBO
dim. 2,24x1,88x1,15h m

Šifra/ code	Opis/description	Cena/ price al pz
1065110	Kompensacioni rezervoar mod. GLOBO X4000LT. Dimenzije kompencacionog rezervoara: 2,24x1,88x1,15h. sa poklopcem sa potpunim otvaranjem in na dve tačke radi lakšeg čišćenja. Tabla sa sondama na tri nivoa, elektroventil 24 V Ø1", prodor VDL preliivanja 63x75x2"1/2, prijemni prolazni prelivni kanali vode 90x110, dva ulaza pumpe Ø63	4.037,00 €
1065111	Kompensacioni rezervoar mod. ATLANTIC - kapaciteta 8.5 m3. Dimenzije kompencacionog rezervoara: 2,36x2,46x1,60h. Kompletna sa poklopcem potpunog otvaranja u dve tačke radi lakšeg čišćenja. Panel sa sondama na tri nivoa elektroventilem 24 V Ø1", prodor VDL prelivni 63x75x2"1/2, prijemni prolazni prelivni kanali vode 90x110, dva ulaza pumpe Ø63	5.988,00 €

Šifra/ code	Opis/description	Cena/ price
1041330	Modul sonde nivoa vode sa 3 elektrode / Sensor module water level with 3 electrodes	401,80 €
1041335	Elektroventil 1" - 24 VAC sa regulatorom protoka / Solenoid valve 1" with flow - 24 VAC	48,70 €
1041336	Elektroventil 1" ½ - 24 VAC sa regulatorom protoka / Solenoid valve 1 ½ " with flow - 24 VAC	148,50 €
1041337	Elektroventil 2" - 24 VAC sa regulatorom protoka / Solenoid valve 2" with flow - 24 VAC	148,80 €
1070058	Mlaznica sa rešetkom 2" Ø63 con 30 cm cev za preliv / Plate with grid 2" Ø63 with 30 cm of overflow pipe	31,40 €
OPREMA PRE - SASTAVLJENA		
1070081	Slivnik poda antivortex c/tubo flessibile Ø50 Ground drainage antivortex c/flexible pipe Ø50	86,30 €
1070082	Slivnik poda antivortex c/fleksibilna cev Ø63 Ground drainage antivortex c/flexible pipe Ø63	101,30 €

SET STUBA KONTROLE NIVOVA KOMPENZACIONOG REZERVOARA Ø 63

Šifra/ code	Opis/description	Cena/ price
1041325	Kompletna sa 2 m di providne cevi + 1 usisna mlaznica RL-319 + 1 koleno + T žens. + 1 kapica žens. + kuglasti ventil + 2 obujmice/ Complete with 2 m of transparent hose + 1 outlet RL-319-1 + elbow + T female + female cap + ball valve + 2 collars	299,10 €

AKRILNE STEPENICE - ACRYLIC STAIRS



STEPENICA ROMANA
ROMAN STAIR



SCALA BALNEO
BALNEO STAIR



STEPENICA OPERA
OPERA STAIR



STEPENICA SOFA
SOFA STAIR

STEPENICE ISPOD LAJNERA - UNDER LINER STAIR



STEPENICA ROMANA
ROMAN STAIR



STEPENICA RELAX
RELAX STAIR

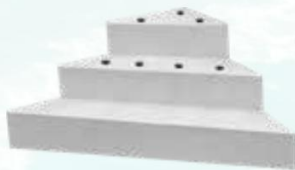

UGAONE STEPENICE
ANGLED STAIR



UGAONE STEPENICE
SA SEDIŠTEM
ANGLED STAIRS
WITH SEAT



KRUŽNE STEPENICE
ROUND STAIR

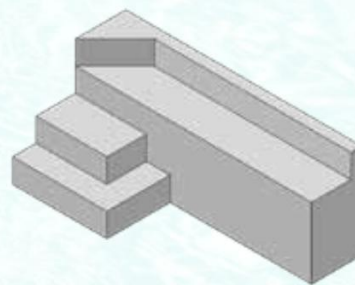
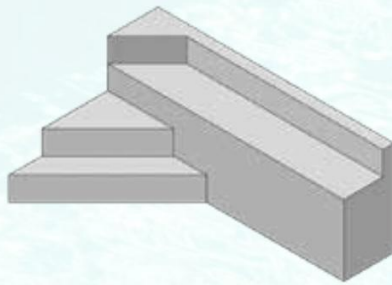

STEPENICE SA KLUPOM SA HIDROMASAŽNIM KOMPLETOM
STAIRS WITH SITTING COMPLETE WITH HYDROMASSAGE JETS KIT

ASORTIMAN AKRILNIH STEPENICA
RANGE OF ACRYLIC STAIRS



Stepenice
Romana



Scala Sofa



Scala Opera

BOJE / COLOURS



Siva
Grey



Plava
Blue



Svetlo plava
Light blue

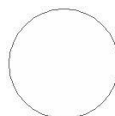

Bela
White



Pesak
Sand

STEPENICE ROMANA



ŠIFRA 1030220 -1030290



ŠIFRA 1030239

Šifra/ code	Opis/description	Širina spoljna	Visina	Broj stepenika	Cena/price
1030220	Stepenice Romana plava / blue stair	2	1,2	3	1.881,00 €
1030221	Stepenice Romana bela / white stair	2	1,2	3	1.881,00 €
1030222	Stepenice Romana sv.plava / light blue	2	1,2	3	1.881,00 €
1030290	Stepenice Romana siva / grey stair	2	1,2	3	1.881,00 €
1030225	Stepenice Romana plava / blue stair	2,5	1,2	4	2.214,00 €
1030226	Stepenice Romana bela / white stair	2,5	1,2	4	2.214,00 €
1030227	Stepenice Romana sv.plava / light blue st	2,5	1,2	4	2.214,00 €
1030228	Stepenice Romana pesak / sand stair	2,5	1,2	4	2.214,00 €
1030229	Stepenice Romana siva / grey stair	2,5	1,2	4	2.214,00 €
1030230	Stepenice Romana plava / blue stair	3	1,2	3	2.659,00 €
1030231	Stepenice Romana bela / white stair	3	1,2	3	2.659,00 €
1030232	Stepenice Romana sv. plava / light blue	3	1,2	3	2.659,00 €
1030233	Stepenice Romana pesak / sand stair	3	1,2	3	2.659,00 €
1030234	Stepenice Romana siva / grey stair	3	1,2	3	2.659,00 €
1030236	Stepenice Romana bela / white stair	3	1,5	4	2.820,00 €
1030237	Stepenice Romana sv.plava / light blue st	3	1,5	4	2.820,00 €
1030238	Stepenice Romana pesak / sand stair	3	1,5	4	2.820,00 €
1030239	Stepenice Romana siva / grey stair	3	1,5	4	2.820,00 €

STEPENICA SOFA / SOFA STAIR



šifra.1030314

ŠIFRA/ code	Opis/description	Širina esterna	Visina	Broj stepenika	Cena/ price
1030311	Stepenice Sofa plava / blue stair	3	1,2	3	2.661,00 €
1030312	Stepenice Sofa bela / white stair	3	1,2	3	2.661,00 €
1030314	Stepenice Sofa pesak / sand stair	3	1,2	3	2.661,00 €
1030315	Stepenice Sofa siva / grey stair	3	1,2	3	2.661,00 €

STEPENICA OPERA / OPERA STAIR



cod.1030303

Šifra/ code	Opis/description	Širina esterna	Visina	Broj stepenika	cena/ price
1030301	Stepenice Opera 150 bela/ white stair	2,5	1,5	4	2.254,00 €
1					
1030303	Stepenice Opera 150 pesak / sand stair	2,5	1,5	4	2.254,00 €
1030304	Stepenice Opera 150 siva / grey stair	2,5	1,5	4	2.254,00 €



STEPENICE BALNEO
BALNEO STAIR

Opis	Spoljna širina	visina	N° stepenik a	Šifra scala + mlaznice	Cena scala + mlaznice	šifra scala +mlaznica+ Set pumpe	Cena scala + mlaznice + set pumpe
Stepenice Balneo plava/ blue stair	3	1,2	3	1030316	3.858,00 €	1030321	5.825,00 €
Stepenice Balneo bela / white stair	3	1,2	3	1030317	3.858,00 €	1030322	5.825,00 €
Scala Balneo pesak / sand stair	3	1,2	3	1030319	3.858,00 €	1030324	5.825,00 €
Scala Balneo siva / grey stair	3	1,2	3	1030320	3.858,00 €	1030325	5.825,00 €

- Može primiti više osoba
- Sedište prostorno i udobno
- Rotirajuće i podesive mlaznice
- Daje benefite hidroterapije
- Can welcome several persons
- Roomy and comfortable seat
- Rotary and adjustable nozzles
- Enjoy real hydrotherapy

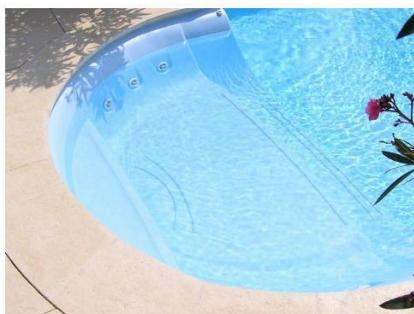

REZERVNI DELOVI ZA STEPENICE

Šifra/ code	Opis/description	Cena/ price
1030330	Prirubnica stepenica 2,00-2,50 / Flange for stairs	184,80 €
1030331	Prirubnica stepenica 3,00 / Flange for stair	200,70 €
1030332	Prirubnica stepenica Rivage / Flange for stairs Rivage	235,00 €
1030333	Horizontalna prirubnica / Horizontal flange	116,20 €
1030334	Vertikalna prirubnica / Vertical flange	100,30 €
1030335	Poklopac prirubnice stepenica 2,00-2,50*	100,30 €
1030336	Poklopac prirubnice scale 3,00* / Flange cover for stairs 3,00	116,20 €
1030337	Poklopac prirubnice scale Rivage* / Flange cover for stairs Rivag	129,40 €
1030338	Poklopac prirubnice horizontalan* / Horizontal flange cover	79,20 €
1030339	Poklopac-prirubnice vertikalni* / Vertical flange cover	42,30 €
1030340	Zaptivka stepenica 2,00-2,50 / Gasket for stairs 2,00-2,50	44,90 €
1030341	Zaptivka stepenica 3,00 / Gasket for stairs 3,00	50,20 €
1030342	Zaptivka stepenica Rivage / Gasket for stairs Rivage	50,20 €
1030343	Vijci stepenica 2,00 / Screws for stairs 2,00	7,90 €
1030344	Vijci stepenica 3,00 / Screws for stairs 3,00	18,70 €
1030345	Vijci stepenica 2,50 e Rivage / Screws for stairs 2,50 and Rivage	15,90 €

*Na raspolaganju boje plava, bela, sv.plava, pesak i siva / *Available in colours blue, white, light blue, sand and grey

STEPENICE ISPOD LAJNERA

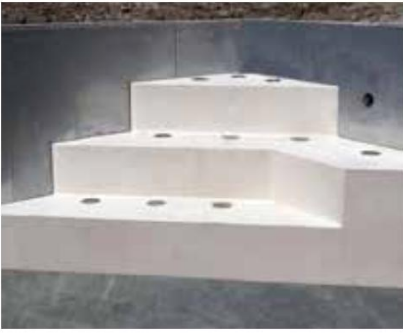

Ugaone stepenice postavljeni liner - Corner stairs laying of the liner



Ugaone stepenice - Corner stairs



Stepenice sa klupom - Stairs with sitting



Sve stepenice ispod lajnera se isporučuju sa setom podrške
All interior under liner stairs are delivered with support kit

STEPENICE ROMANA / ROMAN STAIRS



Šifra/ code	Opis/description	Dužina	visina [m]	br° stepenika	Cena/ price
1030250	Stepenice romana/Roman sta	2,50 m	1,20	3	959,00 €
1030273	Scala romana/Roman stair	3,00 m	4	1.514,00 €	

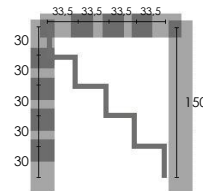
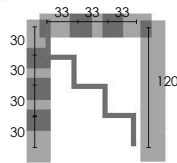

UGAONE STEPENICE / ANGLED STAIRS



Šifra/ code	Opis/description	širina interna [m]			visina [m]	Broj stepenika	Cena/ price
		A	B	C			
1030253	Ugaone stepenice Angled stair	2,4	1,7	1,7	0,9	3	852,00 €
1030276	Ugaone stepenice Angled stair	2,5	1,77	1,77	1,2	4	1.132,00 €

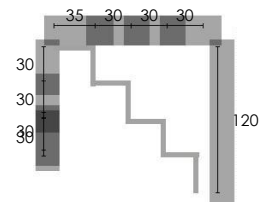
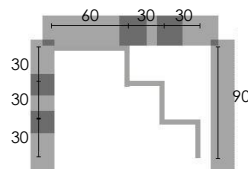
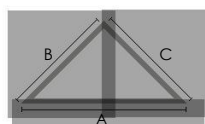

STEPENICE SA KLUPOM SA HIDROMASAŽNIM SETOM
STAIRS WITH SITTING COMPLETE WITH HYDROMASSAGE JETS KIT

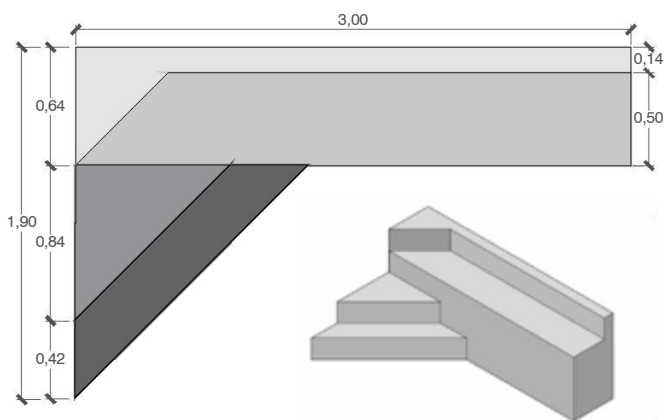

šifra.1030410 (br.2 stepenika) - šifra. 1030413 (br.1 stepenika)

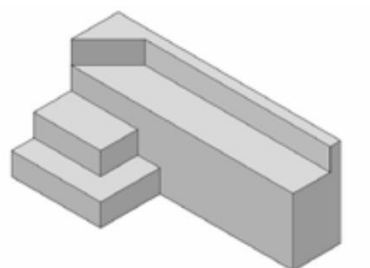
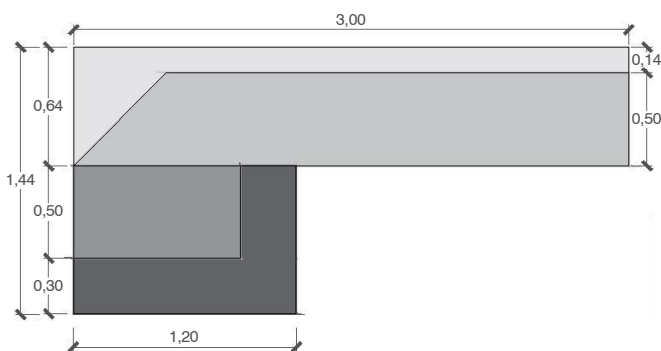

šifra1030412 (N°2 stepenika) - šIFRA. 1030415 (N°1 stepenika)



Šifra/code	Model	Visina totale [cm]	N° stepenika total	Cena/price
	VISINA SEDIŠTA 90 cm- UKUPNA DUŽINA 300 cm - sitting height 90 cm - total length 300 cm			
1030410	Ugaone stepenice sa klupom / Corner stair with sitting	120	4	2.660,00 €
1030412	Ugaone stepenice sa klupom/ Square corner stair with sitting	120	4	2.667,00 €
	VISINA SEDIŠTA SA KLUPOM 60 cm- UKUPNA DUŽINA 300 cm - sitting height 60 cm -			
1030413	Ugaone stepenice sa klupom / Corner stair with sitting	90	3	2.247,00 €
1030415	Ugaone stepenice sa klupom / Square corner stair with sitting	90	3	2.266,00 €
	MODUL PRODUŽETKA KLUPE - BENCH EXTENSION MODULE			
1030420	Modul produžetka klupe - H 60 cm / Bench extension module - H 60 cm	po m		575,00 €
1030421	Modul produžetka klupe - H 90 cm / Bench extension module - H 90 cm	po m		654,00 €

SPOJIVI HIDROMASAŽNI SET (MONOFAZNI) combinable hydromassage kits	Hidro set 4 mlaznice		Set hidro 8 mlaznica		Set hidro 10 mlaznica	
	šifra	cena	šifra	cena	šifra	cena
A – Set hidro mlaznica i fitting A - Hydromassage jets, fittings and pipes	1030417	691,00 €	1030418	944,00 €	1030419	1.091,00 €
B -Komplet opreme za hidromasažu (kompresor,panel,pumpa,bez mašinskog prostora) B - Hydromassage system kit (blower, panel, pump, no tech	1030422	2.295,00 €	1030423	2.768,00 €	1030424	2.814,00 €
C -Set hidromas.opreme (kompresor,panel,pumpa sa mašinskim prostorom od fbg) c -Hydromassage system kit (blower, panel,pump,with technical housing)	1030425	3.246,00 €	1030426	3.739,00 €	1030427	3.858,00 €



download.htm

26

UGAONE STEPENICE SA SEDIŠTEM / ANGLED STAIRS WITH SEAT



Šifra	Opis	Širina unutrašnja [m]			Visina [m]	Br. stepenika	cena
		A	B	C			
1030367	Ugaone Stepenice sa sedištem Corner stair with seat	2,4	1,7	1,7	0,9	3	941,00 €
1030368	Ugaone stepenice sa sedištem Corner stair with seat	2,5	1,79	1,79	1,2	4	1.215,00 €

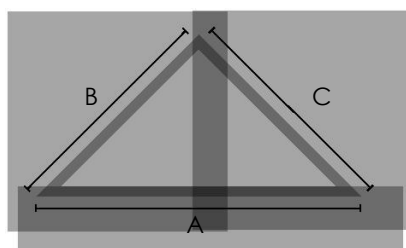

KRUŽNE STEPENICE / ROUND STAIRS

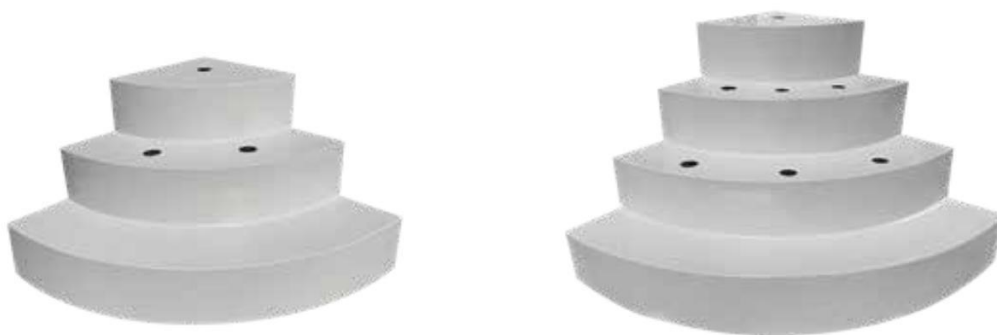

Šifra	Opis	R Spoljni radijus [mm]	Visina [m]	Broj stepenika	Cena
1030272	Kružne stepenice Round stair	1300	0,9	3	780,00 €
1030257	Kružne stepenice Round stair	1600	1,2	4	969,00 €

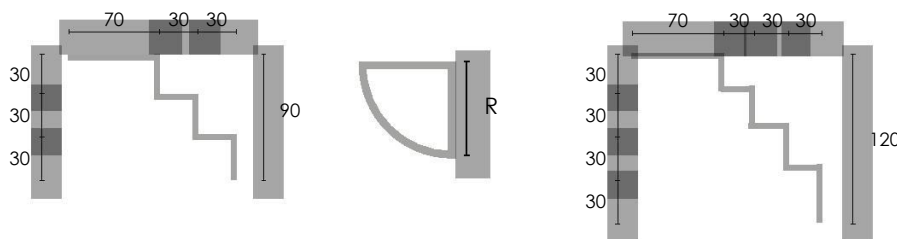

STEPENICE RELAX SA SEDIŠTEM

NEW
NUOVA CONFIGURAZIONE



Šifra/ code	Opis/ description	Duž./ length	Visina/ height [m]	Br. stepenika	cena/ price
1030271	Stepenice relax / Relax	0,5 m	0,9	3	357,00 €
1030270	Stepenice relax / Relax	1,00 m	0,9	3	714,00 €
1030361	Stepenice relax / Relax	2,00 m	0,9	3	1.428,00 €
1030362	Stepenice relax / Relax	2,50 m	0,9	3	1.785,00 €
1030363	Stepenice relax / Relax	3,00 m	0,9	3	2.142,00 €
1030278	Stepenice relax / Relax	0,5 m	1,2	4	439,00 €
1030475	Stepenice relax / Relax	1,00 m	1,2	4	878,00 €
1030364	Stepenice relax / Relax	2,00 m	1,2	4	1.756,00 €
1030365	Stepenice relax / Relax	2,50 m	1,2	4	2.195,00 €
1030366	Stepenice relax / Relax	3,00 m	1,2	4	2.434,00 €

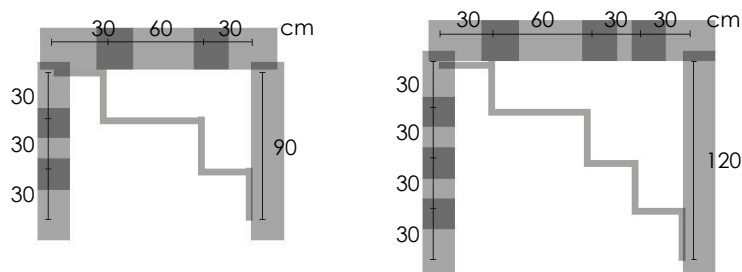

VODOOTPORNE I PROZRAČNE BOJE WATERPROOF AND BREATHABLE PAINT

Vodootporne i prozračne, prijanjaju svakoj površini, starijoj i novoj, obojenoj i ne. Njena svojstva su potpuna nepromočivost i otpornost na vodu, posle nanosa ističe se dobrom hemijskom i na UV zrake otpornošću održavajući bez promena svoje karakteristike za dobar vremenski period. Nanošenje je praktično i brzo a vreme sušenja varira od 30 do 60 minuta (savetuje se ipak da se sačeka bar 3-4 dana pre punjenja bazena).

Waterproof and breathable, the paint adheres to all funds, new and old, painted and not. Its properties are the total impermeability and resistance to water, after film formation is distinguished by a good chemical resistance and UV rays, keeping unchanged its characteristics for a good period of time. Installation is quick and convenient and the drying time varies from 30 to 60 minutes (it is advisable to wait at least 3-4 days before filling the pool). Consumption: 0,10-0,15 kg/m².

Rastvori i iskorišćenje – sa litrom razređivača za boju
Dilutions and yield - with a liter of paint thinner:

Razređivač - Paint thinner	1 : 5
Potrošnja - Consumption	0,10-0,15 kg/m²

Šifra/ code	Opis/description	Cena/ price
1020400	Svetlo plava boja za bazen/ Light blue paint for pool	Limenka / 5 l 285,20 €
1020403	Boja peska z abazen / Sand paint for pool	Limenka / 5 l 285,20 €
1020401	Razređivač boje / Paint thinner	Limenka / 1 l 18,00 €
1020402	Razređivač boje / Paint thinner	Limenka / 5 l 83,70 €

TEČNI SILIKON LIQUID SILICONE

Šifra/ code	Opis/description	Cena/ price
1020440	Vodootporni tečni silikion kg.1 / Waterproof liquid silicone kg.1	68,90 €
1020441	Vodootporni tečni silikon kg.5 / Waterproof liquid silicone kg.5	275,80 €



JEDINSTVENA OBLOGA

Membrane za oblaganje su pametna alternativa tradicionalnim završnim obradama, kao što su pličice ili boje.

Njihov ekskluzivni lak nudi izvrsnu zaštitu od svakodnevnog habanja i prolaska vremena. Brzo i jednostavno se postavljaju prolagođavaju svakom obliku i dizajnu te se lako održavaju. Sistem ojačane membrane ima mnogo prednosti:

- Bolje tehničko i dekorativno rešenje za izgradnju bazena
- Zagarantovana nepromočivost
- Optimalna završna obrada za nove i obnova već postojećih
- Brza i jednostavna instalacija
- Prilagodljiva svim vrstama oblika i dizajna
- Jeftinija od tradicionalnih završnih obrada

A UNIQUE MEMBRANE

Reinforced membranes are the intelligent alternative to traditional finishes, such as tiles or paint.

Their exclusive lacquer affords outstanding protection against everyday wear and tear and the passage of time. They are easy and quick to install, adapt to any shape and design and are effortless to maintain.

The reinforced membrane system has many advantages:

- The best technical and decorative solution for the construction of swimming pools
- Guaranteed watertightness
- The optimum finish for new pools and the renovation of existing ones
- Fast and easy installation
- Adapts to all kinds of shapes and designs
- Less expensive than traditional pool finishes



SAVRŠENA VODONEPROPUSNOST *Watertightness*

Jedinstvena svojstva pružaju najviši nivo sigurnosti i zaštite bazena kao i zaštitu od estetske degradacije, atmosferskog uticaja i habanja. Jednostavna za instalaciju, lako održiva i prilagodljiva svakom nacrtu.

The exclusive properties provide the highest level of security and protection for swimming pools, as well as protecting it from aesthetic deterioration, atmospheric agents and usury. Easy to install, simple to maintain and adaptable to any design.

ZAŠTITA *Protection*

Čuva i štiti vaš bazen baš kao i vašu kožu

Ne samo da pruža najbolju zaštitu od UV zraka, fleka, ogrebotina i biorazgradnje, već je otporan na svakodnevno habanje i dugotrajnu upotrebu.

It safeguards and protects your swimming pool - just like your own skin. Not only does it provide the best protection against UV rays, stains, scratches and biodegradation, but endures against everyday wear and tear and long-term use.

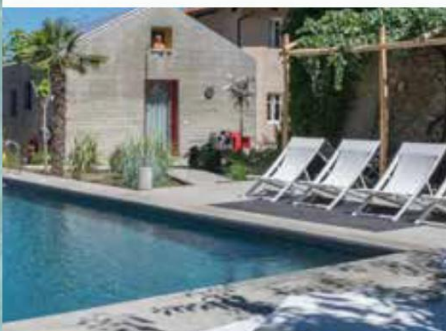



OBNAVLJANJE
Renovation

Membrane za oblaganje garantuju zaštitnu oblogu za vaš bazen bez obzora na njegov oblik i dimenzije. Koristi se u izgradnji i renoviranju javnih i privatnih bazena jer se može postaviti na sve vrste postojećih površina kao što su pločice, mozaik, beton i poliester

Lining membranes guarantee a protective liner for your pool, regardless of its form, shape or size. It is widely used in construction, public and private pools restructuring, as it can be installed over all manner of existing surfaces, including tile, mosaic, cement and polyester.



ŠIROK IZBOR
Selection

Nudi se veoma širok asortiman membrani i lajnera, razložen u dopadljivim rešenjima za vodonepropustivosti bazena. Boje, teksture i inovativni dizajn tako su osmišljeni da daju veoma savremen izgled bazenu.

We offer a wide range of membranes and liners, diversified in pleasant solutions for the waterproofing of the pool. Colours, textures and innovative designs have been conceived to give a very contemporary look to the pool.



**AQUALINER 75/100 E LINER IN PVC JEDNOBOJNI ILI ŠTAMPANI
PVC LINER IN SOLID COLOURS OR PRINTED**

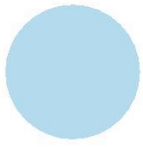

svetlo plava
light blue



pesak
sand

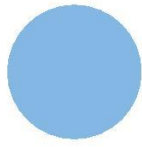

plava
blue

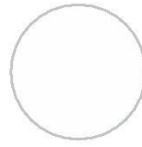

bela
white

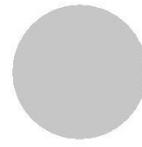

siva
grey

TRAJNOST
10 GODINA
garancije



ardesia
slate



granit pesak
granite sand



granito siva
granite grey



granit zelena
granite green

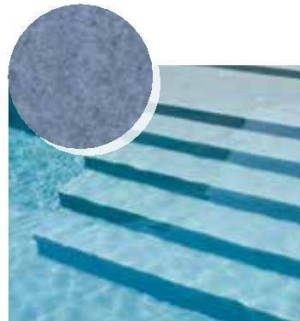

granit plava
granite blue

TRAJNOST
10 GODINA
garancije

PROTIV-FLEKA
3 GODINE
garancije

Opis /description	cena jednobojna/ price solid color	Cena štampani/ price printed shade
Aqualiner 75/100 – pravougaoni bazeni, ravno dno - po m ² Aqualiner 75/100 - rectangular swimming pools, flat bottom - per m ²	26,90 €	34,30 €

Per altre forme di piscina e altri tipi di fondo contattateci / For other shapes of swimming pool and other types of bottoms please contact us

	JEDNOBOJNI					ŠTAMPANI				
Šifra	1050580	1050581	1050582	1050583	1050584	1050940	1050941	1050942	1050943	1050944
Boja	Svetla plava	pesak	plava	bela	siva	ardesia	granit pesak	granit plava	granit siva	granit zelena

Određiti pri narudžbi po davanju šifre vrstu kačenja: Hung, Overlap / Specify when ordering the type of hooking: Hung, Overlap
Ako je aqualiner < a 25 m² nadmera od 10% / If the aqualiner is < than 25 m² plus-value of 10%

VRSTE KAČENJA: HUNG, OVERLAP LINER LOCKING TRACK: HUNG, OVERLAP

2 VRSTE KAČENJA

Svi naši Aqualiner mogu biti isporučeni sa dve vrste kačenja: KAČENJE HUNG - KAČENJE OVERLAP.

Our Aqualiner can be finished with any of the two types of liner locking track configurations: HUNG AND OVERLAP.



Nikakav vidljivi var, nikakva razlika u boji
No visible weld, no colour difference



Boja ili štampa savršeno homogeni,
ispoštovan štampani motiv
Homogenous colour or pattern, pattern
respected



- KAČENJE HUNG / HUNG LINER LOCKING TRACK
- Višegodišnja pouzdanost
- Bez vidljivog vara ns gornjem kraju lajnera I,

- Nikakva vidljiva razlika u boji, između membrane i profila kačenja lajnera
- Jednoobrazno starenje membrane
- Kompletna otpornost na mikroorganizme i U.V. zracima
- Savršeno homogena boja
- Poštovanje crteža u slučaju pojaseva ili štampane membrane

- *Ultra-annual reliability*
- *No visible welds around the upper periphery of the liner, guaranteeing an incomparable aesthetic*
- *No visible colour difference between the liner and the liner locking track*
- *Uniform ageing of the membrane*
- *Resistant to attack from micro-organisms and UV radiation*
- *Perfectly homogenous colour*
- *The design of patterned liners and tile bands is respected*



- KAČENJE OVERLAP / OVERLAP LINER LOCKING TRACK
- Ova vrsta kačenja omogućava regulisanje visine lajnera u momentu njegovog polaganja na gradilištu. Lajner mora biti upakovan sa dodatnom visinom od cca 10 cm, omogućavajući regulisanje ovakvog podešavanje. Pojedine konstrukcije su opremljene aluminijumskom vodičom Overlap. Po zahtevu možemo upakovati lajner sa ovakvom vrstom kačenja, u tom slučaju biće dobro predvideti visinu zida veću od 10cm nad postavljenim lajnerom.

- *With this type of liner locking track, the height of the liner can be adjusted on site. The liner must be an additional 10 cm high to allow for this adjustment. Some constructions are fitted with alluminium Overlap tracks. We can manufacture liners with this type of liner locking track on request, do not forget to add an additional 10 cm to the height of the finished liner..*

FLAGON MEMBRANA ZA OBLAGANJE ZA VEŠTAČKA JEZERA / MEMBRANE FOR ARTIFICIAL LAKE

FLAGON CSL obložna membrana za jezercer, siva boja, debljine 1,5 mm, visina 2,10 m, rolna od 20 m.

FLAGON AT membrana obložna netoksična za prehrambene bazene (bela boja) ili za ribe (tamno siva boja) debljine 1,5 mm, visina 2,10 m, rolna od 20 m.

CSL Flagon membrane for ponds, color grey, thickness 1.5 mm, height 2.10 m, 20 m roll.

AT Flagon non-toxic membrane for food reservoir (white) or fish (dark grey) thickness 1.5 mm, height 2.10 m, 20 m roll.

Šifra/ code	Opis/description	cena/price m ²
1050560	Flagon CSL siva / grey	31,40 €
1050561	Flagon AT bela prehrana / food reservoir (white)	32,20 €
1050562	Flagon AT ribe tamno sivi / fish (dark grey)	32,20 €

INDIKATOR TRAKA / MARK LANES

ŠIFRA/ code	Opis/description	Cena/ price m
1050516	Indikator traka debljine 1,5 mm - širina 25 cm - dužina 25 m crno / mark lane thick.1,5mm - width 25 cm - length 25 m	12,90 €



ASORTIMAN RENOLIT RANGE RENOLIT



Tamno siva / dark grey



2000
Collection



Tamno siva / dark grey



RELIEF
Collection

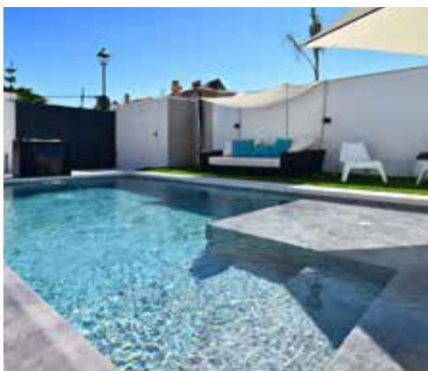

Tamno siva / dark grey



RENOLIT ALKORPLAN
VOGUE



Touch Elegance

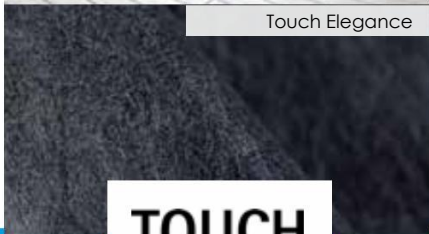

TOUCH
Collection



Natural Pool zelena lakirana



RENOLIT ALKORPLAN
NATURAL POOL
Bio-piscine



ALIVE Chandra

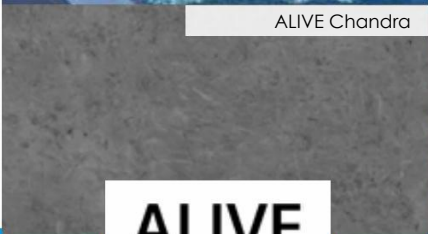

ALIVE
Collection

ALKORPLAN 1000 MEMBRANA OD PVC ARMIRANOG JEDNOBOJNA / PVC MEMBRANE IN SOLID COLORS

Membrana PVC deblj. 1,5 mm pogodna za oblaganje bazena, armirana iznutra sa poliestere. Isporuka u rolnama od 25 m.
 PVC membrane thickness of 1.5 mm suitable for covering swimming pools, armed internally with polyester mesh. Supplied in rolls of 25 m.

Šifra jednobojne h 1,65m	opis	cena po m ² jedna boja h 1,65m
1050700	Alkorplan 1000 svetlo plava / light blue	24,00 €
1050701	Alkorplan 1000 plava / blue	24,00 €
1050703	Alkorplan 1000 bela / white	24,00 €
1050704	Alkorplan 1000 siva / grey	24,00 €
1050706	Alkorplan 1000 pesak / sand	24,00 €

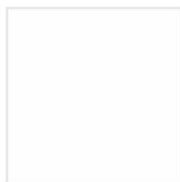

bela/white



svetlo plava/light blue



plava/blue



pesak/sand



siva/grey

ALKORPLAN T2000 - MEMBRANA od PVC ARMIRANOG JEDNOBOJNA / PVC MEMBRANE IN SOLID COLORS

Membrana PVC debljine 1,5 mm pogodna za oblaganje bazena, sačinjena od dva presovana sloja u polihloruru fleksibilnog vinila (PVC-P) i ojačana mrežom poliestera. Polaganje putem varenja toplim vazduhom (termofuzija). Boja acrilina zaštitina. Isporuka u rolnama od 25 m.
 PVC membrane thickness 1,5 mm suitable for coating swimming pools, made up of two layers of polyvinyl chloride calendered flexible (PVC-P) and reinforced with a polyester mesh. Assembled by hot air welding (hot melt). Acrylic paint protection. Supplied in rolls of 25 m.

Šifra jednobojne h 1,65	Šifra jednobojne h 2,05	Opis	Cena pom ² Jednobojna h 1,65	cena po m ² jednobojna h 2,05
1050720	1050728	Alkorplan T2000 svetlo plava / light blue	36,80 €	36,80 €
1050721	1050729	Alkorplan T2000 plava / plava	36,80 €	36,80 €
1050722	1050732	Alkorplan T2000 zelena Caraibi / zelena	36,80 €	36,80 €
1050723	1050772	Alkorplan T2000 bela / bela	36,80 €	36,80 €
1050724	1050730	Alkorplan T2000 siva / siva	36,80 €	36,80 €
1050725	1050733	Alkorplan T2000 tamno siva / tamno siva	36,80 €	36,80 €
1050727	1050731	Alkorplan T2000 pesak / pesak	36,80 €	36,80 €
1050754	-	Alkorplan T2000 crna / crna	36,80 €	-



Svetlo plava/light blue



pesak/sand

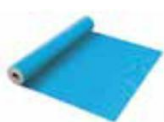

plava/blue

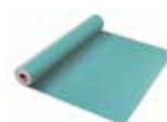

zelena Caraibi/green



bela/white



siva/grey



tamno siva/dark grey



tamno siva / dark grey



svetlo plava



plava / blue

ALKORPLAN RELIEF PROTIVKLIZNA - MEMBRANA OD PVC ARMIRANOG / NON-SLIP PVC MEMBRANE

Membrana PVC debljina 1,8 mm sa površinskim protivkliznim reljefnim presovanjem, pogodna za oblaganje bazena, sastavljena od dva presovana sloja od vinilskog fleksibilnog polihluora (PVC-P) i pojačana mrežom poliestera. Polaganje putema vara na topli vazduh (termofuzijom). Zaštitna akrilna boja. Isporuka u rolnama od 5 do 25 m.

PVC membrane thickness 1,8 mm with non-slip surface embossing, suitable for coating swimming pools, made up of two layers of polyvinyl chloride calendered flexible (PVC-P) and reinforced with a polyester mesh. Assembled by hot air welding (hot melt). Acrylic paint protection. Supplied in rolls of 25 m.

Šifra rolne da 5 m - 8,25 m ²	Šifra po m ² 25x1,65 m	Opis	NEW	
			Cena rolne da 5 m - 8,25 m ²	Cena po m ² 25x1,65 m
1050833	1050483	Alkorplan Relief protivklizna belo/white	376,20 €	41,40 €
1050834	1050484	Alkorplan Relief protivklizna plavo/blue	376,20 €	41,40 €
1050835	1050485	Alkorplan Relief protivklizna zelena caraibi/green	376,20 €	41,40 €
1050836	1050486	Alkorplan Relief protivklizna svetlo plava/light blue	376,20 €	41,40 €
1050837	1050487	Alkorplan Relief protivklizna pesak/sand	376,20 €	41,40 €
1050838	1050488	Alkorplan Relief protivklizna siva/grey	376,20 €	41,40 €
1050839	1050489	Alkorplan Relief protivklizna tamno siva/dark grey	376,20 €	41,40 €
1050840	1050741	Alkorplan Relief protivklizna crna/black	376,20 €	41,40 €



bianco/white



celeste/light blue



azzurro/blue



sabbia/sand



grigio/grey



grigio scuro/dark grey

ALKORPLAN ALIVE MEMBRANA IN PVC-P / PVC-P MEMBRANE ALKORPLAN ALIVE

ALIVE
Collection

Membrana presovana u fleksibilnom polivinilnom hloruru PVC-P i armirana sa poliesterskom mrežom pogodnom za nepromočivost bazena. Zaštićena specijalnom i eskluzivnom akrilskom bojom. Iporučena u rolnama od 25 m.

Flexible PVC-P polyvinyl chloride calendered membrane reinforced with polyester mesh suitable for waterproofing swimming pools. Protected with special, unique acrylic paint. Supplied in rolls of 25 m.

Šifra h 1,65 cm	Opis	NEW	
		Cena po m ² h.1,65 m	
1050810	Alkorplan Alive PRANA	48,30 €	
1050811	Alkorplan Alive DHYANA	48,30 €	
1050812	Alkorplan Alive CHANDRA	48,30 €	



ALIVE Prana



ALIVE Chandra

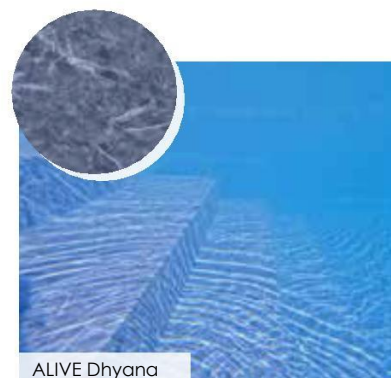

ALIVE Dhyana

ALKORPLAN VOGUE MEMBRANA OD PVC ARMIRANOG ŠTAMPANOG / PRINTED PVC MEMBRANE

Membrane ALKORPLAN VOGUE e TOUCH nisu samo štampane, već reljefno presovane i urezane, dobijajući trodimenzionalni efekat. Imaju debljinu od 2 mm, isporučene u rolnama od 21 m.

The membranes Alkorplan Vogue and Touch are not only printed but also embossed and incised, obtaining a tridimensional effect. They have a thickness of 2 mm. Supplied in rolls of 21 m.

Šifra/code	Opis/description	Dimenzije/size	Cena po m2/price at m2
1050803	Alkorplan Vogue Vintage	h 165 m	63,90 €
1050805	Alkorplan Vogue Urban	h 165 m	63,90 €
1050806	Alkorplan Vogue Summer	h 165 m	63,90 €
1050801	Alkorplan Vogue Tropical	h 165 m	63,90 €

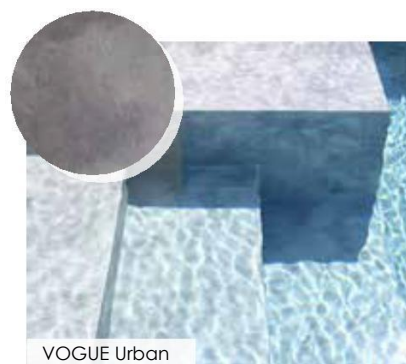

ALKORPLAN TOUCH E VOGUE DISPLAY

Šifra/code	Opis/description	Dimenzije/size	Cena/price
1041315	Display stoni	Alkorplan touch 53x31x12	120,50 €
1041317	Display stoni	Alkorplan vogue 53x31x12	120,50 €

ALKORPLAN TOUCH
MEMBRANA OD PVC ARMIRANOG ŠTAMPANA / PRINTED PVC MEMBRANE

TOUCH
Collection

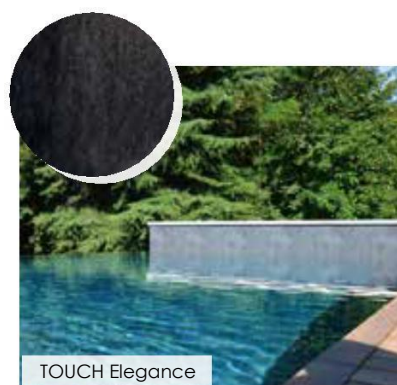

Šifra štampana h 1,65	Opis	Cena po m ² štampano h1,65
1050757	Alkorplan TOUCH Elegance / Elegance	63,90 €
1050758	Alkorplan TOUCH Relax / Relax	63,90 €
1050759	Alkorplan TOUCH Authentic / Authentic	63,90 €
1050777	Alkorplan TOUCH Vanity / Vanity	63,90 €
1050778	Alkorplan TOUCH Sublime / Sublime	63,90 €
1050779	Alkorplan TOUCH Prestige / Prestige	63,90 €
1050774	Alkorplan TOUCH Origin / Origin	63,90 €

Šifra	Opis	Cena
1050870	Tračica fiksiranje na zid TOUCH debljine 1,5 mm - širine. 9 mm - dužina 25 m	36,70 €

FRISE TOUCH

FRISE TOUCH za dekoraciju bazena jedinstvenim stilom, sa klasom i kvalitetom asortimana TOUCH. Reljefno presovanje Klase C dodeljuje ovim frizama protivklizni kvalitet i dimenzije 33cmx20m prave ih posebno prilagodljivim i podesivim na svakoj tački : ivica, stepenica, preliva ili dekorativnih umetaka.

FRISE TOUCH to decorate the pool with a unique style, with the class and quality of the TOUCH range. The C-class embossing gives these frise the non-slip quality and the dimensions of 33cmx20m make them particularly versatile and applicable at any point of the pool: edges, steps, overflows or decorative inserts.



IVICE



STEPENICE



UMETCI

Šifra/ code	Opis/description	Dimenzije		Cena/ price
1050771	Frise TOUCH Prestige / Frise TOUCH Prestige	h33cm x L20m x sp 2 mm	po rolni/roll	596,70 €
1050773	Frise TOUCH Sublime / Frise TOUCH Sublime	h33cm x L20m x sp 2 mm	po rolni/roll	596,70 €

PVC TEČNI ZA ALKORPLAN / LIQUID PVC FOR ALKORPLAN

Šifra/ code	Opis/description	Limenka/jar	Cena/price
1050745	Pvc tečni Alkorplan sv.plavi / light blue liquid pvc	0,9 kg	52,20 €
1050746	Pvc tečni Alkorplan plavi / blue liquid pvc	0,9 kg	52,20 €
1050747	Pvc tečni Alkorplan zeleni Caraibi / green liquid pvc	0,9 kg	52,20 €
1050748	Pvc tečni Alkorplan beli / white liquid pvc	0,9 kg	52,20 €
1050749	Pvc tečni Alkorplan sivi / grey liquid pvc	0,9 kg	52,20 €
1050750	Pvc tečni Alkorplan tamno sivi / dark grey liquid pvc	0,9 kg	52,20 €
1050752	Pvc tečni Alkorplan pesak / sand liquid pvc	0,9 kg	52,20 €
1050753	Pvc tečni Alkorplan providni / transparent liquid pvc	0,9 kg	52,20 €
1050751	Pvc tečni Alkorplan crni / black liquid pvc	0,9 kg	52,20 €
1050851	Pvc tečni Alkorplan elegance / elegance liquid pvc	0,9 kg	84,00 €
1050852	Pvc tečni Alkorplan relax / relax liquid pvc	0,9 kg	84,00 €
1050853	Pvc tečni Alkorplan authentic / authentic liquid pvc	0,9 kg	84,00 €
1050864	Pvc tečni Alkorplan vanity / vanity liquid pvc	0,9 kg	84,00 €
1050865	Pvc tečni Alkorplan sublime / sublime liquid pvc	0,9 kg	84,00 €
1050866	Pvc tečni Alkorplan prestige / prestige liquid pvc	0,9 kg	84,00 €
1050878	Pvc liquido Alkorplan origin / origin liquid pvc	0,9 kg	84,00 €
1050807	Pvc tečni Alkorplan Vogue Vintage	0,9 kg	84,00 €
1050808	Pvc tečni Alkorplan Vogue Urban	0,9 kg	84,00 €
1050809	Pvc tečni Alkorplan Vogue Summer	0,9 kg	84,00 €
1050802	Pvc tečni Alkorplan Vogue Tropical	0,9 kg	84,00 €
1050813	Pvc tečni Alkorplan Alive Prana	0,9 kg	52,20 €
1050814	Pvc tečni Alkorplan Alive Dhyana	0,9 kg	52,20 €
1050815	Pvc tečni Alkorplan Alive Chandra	0,9 kg	52,20 €
1050534	Bočica + čep za aplikaciju tečnog PVC/ Bottle + cap for the application of liquid PVC		12,10 €

ALKORPLAN BIO-BAZENI ALKORPLAN NATURAL POOL

Nepromočiva membrana od PVC-P ojačana u poliesteru, debljine 1,5 mm, namenski kreirana za bio-bazene i jezera privatne upotrebe. Obloga Alkorplan BIO-BAZENI poštuje i ne šteti ribama i biljkama. Isporuka u rolnama od 20 m.

TEHNIČKE KARAKTERISTIKE:

- Netoksične za ribe i vodene biljke
- Otporan na pucanje i oticanje
- Velika otpornost na bušenje
- Otporan na penetraciju korenja
- Lako se vari toplim vazduhom

Waterproofing membranes of flexible polyvinyl chloride (PVC-P) with a polyester reinforcing, 1,5 mm thick. Designed for natural swimming. RENOLIT ALKORPLAN natural swimming pool liner is fish and plant friendly. Supplied in rolls of 20 m

TECHNICAL FEATURES:

- *pools and small swimming ponds for private use*
- *non-toxic for fish and aquatic plants*
- *resistant to swelling and rotting*
- *high resistance to puncturing*
- *root resistance*
- *very easy to weld with hot air*

BOJE NA RASPOLAGANJU / AVAILABLE COLOURS



Zelena lakirana
Lacquered green



Tamno siva
Dark Grey



Crna
Black



CRNA BOJA omogućava brže zagrevanje vode.

The black colour makes the water warm up faster

Šifra/ code	Opis/description		Cena/ price h 2,05
1050879	Alkorplan BIO BAZENI – lakirana zelena / lacquered green	NEW	€/ m2 32,90 €
1050871	Alkorplan BIO BAZENI – tamno sivo / dark grey		€/ m2 29,60 €
1050873	Alkorplan BIO BAZENI - crna / black		€/ m2 29,60 €

ALKORPLAN HIDRAULIČNA LINIJA HYDRAULIC LINE

Alkorplan 35052 sintetički pokrivač u PVC-P homogen netoksičan Neotporan na UV zrake . Pogodan za realizaciju bazena , akumulacionih bazena pitke vode. Siva otvorena boja, debljine 1,5 mm, visina 2,15 m, rolna od 15 metara.

Synthetic membrane in PVC-P homogeneous non-toxic, not UV resistant. Suitable for the construction of basins for the accumulation of drinking water. Color light grey, thickness 1.5 mm, height 2.15 m, 15 meters rolls.

Alkorplan 35254 sintetički pokrivač od PVC-P homogen otporan na UV zrake. Pogodan za frealizaciju kanala, basena, uvalica, ukrasnih malih jezera. Boja siva cink, debljina 1,5 mm, visina 2,15 m, rolne od 20 metara.

Synthetic membrane in PVC-P homogeneous, UV resistant. Suitable for the construction of canals, lagoons, ornamental lakes. Color zinc grey, thickness 1.5 mm, height 2.15 m, 20 meters rolls.

Šifra/ code	Opis/description		cena/ price
1050860	Alkorplan 35052 svetlo siva / light grey	€/ m2	28,10 €
1050861	Alkorplan 35254 cink siva / zinc grey	€/ m2	23,20 €

PROIZVODI ZA ALKORPLAN / PRODUCTS FOR ALKORPLAN

Alkorplus Sanitized: Idealan proizvod za prevenciju širenja mikroorganizama i gljivica u prostoru između zida i membrane Alkorplan.

The ideal product to prevent the proliferation of microorganisms and fungi in the area between the pool wall and membrane Alkorplan.

Alkorplus protiv-fleka: Mineralni proizvod, koncentrat od 30%, neutralizuje razne metalne jone među kojima bakar, olovo, kadmijum, srebro, smanjuje prisustvo rastopljenih metala u vodi koja bi mogli prouzrokovati fleke ili diskoloraciju membrane.

Mineral product, concentrated to 30%, neutralizes various metal ions including copper, lead, cadmium, silver, reduces the presence of dissolved metals in pool water that could cause staining or discoloration of the membrane.

Alkorclean odmašćivač: Preparat za periodično čišćenje naslaga masnoće i prljavštine na površini vode.

Produced for the periodic cleaning of grease and dirt deposits on the water line

Šifra/ code	Opis/description		cena/ price
1050760	Rastvarač THF – limenka od 1 l / Solvent jar 1 l		48,40 €
1050762	Alkorplus Sanitized -bočica od 1 l / Jar 1 l		77,00 €
1050763	Alkorplus protiv fleka - bočica od 1 l / Stain jar 1 l		86,40 €
1050775	Alkorclean odmašćivač - bočica od 1 l / Degreasing jar 1 l		27,10 €
PRIBORI/ACCESSORIES			
1050776	Plastificirani lim plave boje debljine mm.1,4 - šir. m 1,00 -duž. m 2,00 / Plastic-coated sheet met	al pz	169,20 €
1050435	Ugaoni profil plave boje a 90° deb. mm.2 - šir. cm 5x5 - duž. m 2,00 / Blue 90° angle profile	al pz	34,70 €
1050765	Indikator traka deblj. mm1,5 - šir. cm 25 - duž. m 25 crna / Mark lanes	al m	17,30 €
1050854	Povezna traka var Alkorplan Touch deblj. 1,5mm - širina. cm 15 - rolna m.20 / Backing strip	al rotolo	439,60 €

ALKORPLUS 81006

Alkorplus TNT: od polipropilene svitlo plavi tretiran sa prirodnim antibakterijskim aditivima na bazi metalnih jona, za konstantno antibakterijsko dejstvo. Težina 400 gr/m

Fleece membrane in polypropylene light blue treated with natural antibacterial additives based on metal ions. Weight 400 gr/m²

Šifra/ code	Opis/description		Cena/ price
1050428	Zaštitna prostirka Alkorplus 1,50 x 50 m	Po rolni	888,60 €
1050429	Zaštitna prostirka Alkorplus 2,00 x 50 m	Po rolni	1.184,70 €

ASORTIMAN ELBTAL



pesak / sand



pesak / sand



pesak / sand



Pure Terra Sand



Island dreams Aruba



Blu Perta



ELBTAL 150/100 - MEMBRANA PVC ARMIRANI JEDNOBOJNA, DEBLJINE 1,50 MM
ELBTAL 150/100 - SOLID COLOR OR PRINTED PVC MEMBRANE 1,5 MM



TEHNIČKE KARAKTERISTIKE: otporna na UV zrake, otporna na hladnoću i atmosferski uticaj, lako se vari, bez Teških i fizioloških metala, besprekorna po stanfordima EN 71 / 3, otporna na sve uobičajene hemijske proizvode za tretman vode u bazenima, na raspolaganju i protivklizna verzija u debljini od 2,00 mm.

The coating Elbtal, German product, is a plasticized membrane in PVC (PVC-P) reinforced with fiber. It's available in plain and printed. SPECIFICATIONS: UV-resistant, cold resistant and weatherproof, good weldability, free of heavy and physiological metals unobjectionable according to EN 71/3, resistant to all usual chemicals for water treatment in swimming pools, also available in slip thickness of 2.00 mm.



Šifra bela boja h1,65x25m	Šifra protivklizna h1,65x10m	Šifra jednobojna h2,00x25m	Opis	Cena po m2 h1,65x25m	Cena po m2 protivklizna h1,65x10m	Cena po m2 h2,00x25m
1050605	1050615	1050610	Elbtal svetlo plava / light blue	24,10 €	35,00 €	24,10 €
1050606	1050616	1050611	Elbtal plava / blue	24,10 €	35,00 €	24,10 €
1050607	1050617	1050612	Elbtal bela / white	24,10 €	35,00 €	24,10 €
1050627	1050628	-	Elbtal siva / grey	24,10 €	35,00 €	-
1050609	1050619	-	Elbtal zelena Caraibi / green	24,10 €	35,00 €	-
1050608	1050618	1050613	Elbtal sabbia / sand	24,10 €	35,00 €	24,10 €
1050629	1050645	-	Elbtal crna / black	24,10 €	35,00 €	-
1050646	1050604	-	Elbtal siva antracite / dark grey	24,10 €	35,00 €	-

ELBTAL ELITE MOTION - MEMBRANA SA OJAČANOM OBLOGOM RELJEFNA 3D
ELBTAL ELITE MOTION - REINFORCED MEMBRANE WITH 3D RELIEF

Membrane Elite Motion poseduju sve tehničke karakteristike kao Elite, kao što je ogromna otpornost na hlor, na fleke, diskoloraciju, UV zrake a nude i vizuelni, opipni i funkcionalni jedinstveni doživljaj. Zahvaljujući reljefu 3D i zagarantovanoj protivkliznoj površini (klasifikacije klasa C), Elite Motion garantuje maksimalnu sigurnost na stepenicama, nizbrdicama i ulaznim površinama svakog bazena.

Nudi takođe kompletnu zaštitu protiv prljavštine duž površinske linije.
 Raspoložive debljine 1,8 mm, širina 165 cm i dužina rolne 5,25 m o 21 m.

Elite Motion membranes possess all the technical properties of Elite, such as extreme resistance to chlorine, staining, discoloration and UV rays, and offer a unique visual, tactile and functional experience. Thanks to its 3D relief and certified anti-slip surface (Class C classification), Elite Motion provides maximum safety on steps, slopes and entry areas of any pool. It also offers complete protection against dirt along the waterline.
 Available in 1.8 mm thickness, 165 cm width and 5 or 21 m roll length.



Šifra rolne da 5,25 m - 8,65 m ²	Šifra po m ² 21x1,65 m	Opis	cena rolne od 5,25 m - 8,65 m ²	Cena po m ² 21x1,65 m
1050933	1050927	Elbtal Elite Motion- Bela led / Arctic White	394,00 €	41,30 €
1050934	1050928	Elbtal Elite Motion - Pesak / Sand Beach	394,00 €	41,30 €
1050935	1050929	Elbtal Elite Motion - Plava / Blue Sky	394,00 €	41,30 €
1050936	1050930	Elbtal Elite Motion - Plava / Deep Sea	394,00 €	41,30 €
1050937	1050931	Elbtal Elite Motion – Svetlo siav / Grey Rock	394,00 €	41,30 €
1050938	1050932	Elbtal Elite Motion - Antracite / Anthracite	394,00 €	41,30 €

ELBTAL ELITE - MEMBRANA ZA OBLAGANJE OJAČANA ELBTAL ELITE - REINFORCED MEMBRANE



TEHNIČKE KARAKTERISTIKE:

Otporna na Creme Solari: testovi pokazuju otpor na fleke od 300% u poređenju sa nekim standardnim platnom. Otporan na površinske fleke: ojačana membrana onemogućava penetraciju solarnih krema, kozmetici i ostale hemijske supstance koje skidaju boju membrani ili je flekaju, naročito površinski nivo pod efektom UV radijacija, omogućavajući lakše održavanje čistoće bazena. Otporan na UV zrake. Otporan na hemijske proizvode kao hlor, jedan od razloga diskoloracije cerada.

The reinforced membrane Elbtal Elite has a special acrylic surface coating, that is produced without phthalate, making it the healthiest swimming pool membrane on the market.

SPECIFICATION:

Stain Resistance: the reinforced membrane prevents the penetration of sun cream, cosmetics and other chemicals, e.g. chlorine, that discolor the membrane or cause stains, especially on the waterline under the effect of UV radiation. That makes Elite easy to clean. UV Radiation Resistance. Chlorine Discoloration: typically occurring over time. The durable elite membrane strongly resists chemical substances such as chlorine.

OTPORAN*
NA FLEKE
5 GODINA
garancije

OTPORAN*
NA HLOR
5 GODINA
garancije

* Vedeti našu garanciju
i priručnike za tretman vode

* See our warranty and water
treatment guides.



RASPOLOŽIVE BOJE/AVAILABLE COLOURS



Bela led
Arctic White



Pesak
Sand Beach



Svetlo plava
Blue Sky



Plava
Deep Sea



Svetlo siva
Grey Rock



Šifra h1,65	Membrana Rolna debljine 1,5 mm x širina 1,65m x dužina 25m - 41,25 m2 Roll thickness 1,5 mm x width 1,65m x length 25m - 41,25 m2	cena al m2 h1,65
1050664	Elbtal ELITE – Bela led / Arctic White	36,30 €
1050665	Elbtal ELITE - Pesak / Sand Beach	36,30 €
1050666	Elbtal ELITE - Plava / Blue Sky	36,30 €
1050667	Elbtal ELITE – Tamno plava/ Deep Sea	36,30 €
1050668	Elbtal ELITE – Svetlo siva / Grey Rock	36,30 €
1050696	Elbtal ELITE – Tamno siva / Black stone	36,30 €

Šifra protivklizna h1,65	Protivklizna Rolna debljine 1,5 mm x širina 1,65m x dužina 10m - 16,50 m2 Roll thickness 1,5 mm x width 1,65m x length 10m - 16,50 m2	Cena po m2 protivklizna h1,65
1050669	Elbtal ELITE – Bela led / Arctic White	51,90 €
1050670	Elbtal ELITE - Pesak/ Sand Beach	51,90 €
1050671	Elbtal ELITE - Plava / Blue Sky	51,90 €
1050672	Elbtal ELITE – Tamno plava / Deep Sea	51,90 €
1050673	Elbtal ELITE – Svetlo plava / Grey Rock	51,90 €
1050697	Elbtal ELITE – Tamno siva / Black stone	51,90 €

Šifra/code	PVC Tečni - Limenka od/Can 0,9 l	Prezzo/priče m2
1050674	Elbtal ELITE – Bela led / Arctic White	59,10 €
1050675	Elbtal ELITE - Pesak / Sand Beach	59,10 €
1050676	Elbtal ELITE - Plava / Blue Sky	59,10 €
1050677	Elbtal ELITE – Tamno plava / Deep Sea	59,10 €
1050678	Elbtal ELITE – Svetlo siva / Grey Rock	59,10 €
1050698	Elbtal ELITE – Tamno siva / Black stone	59,10 €

ELBTAL PURE POOL PASSION- MEMBRANA ZA OBLAGANJE PRIRODNIH BOJA
ELBTAL PURE POOL PASSION - COATING MEMBRANE IN NATURAL COLOURS



Membrana armirana (PVC-P) sa površinom 3D i zaštitnim lakom, za unutrašnje i spoljne bazene. Pure Pool Passion je otporna na UV zrake, hlor, bakterije, ogrebotine. Njena tekstura pravi dopadljiv efekat 3D u prirodni bojama Terra Sand i Ocean Grey. Laka za polaganje sa tehnikom sučeonog vara i minimalnog dimljenja, proizvedena je po standardima EN 15836-2.

Reinforced membrane (PVC-P) with 3D surface and protective lacquer, for indoor and outdoor pools. Pure Pool Passion is UV-, chlorine-, bacteria- and scratch-resistant. Its texture creates a pleasant 3D effect in the natural colours Terra Sand and Ocean Grey. Easy to install with the head-to-toe welding technique and minimal smoke development, it is manufactured according to EN 15836-2.

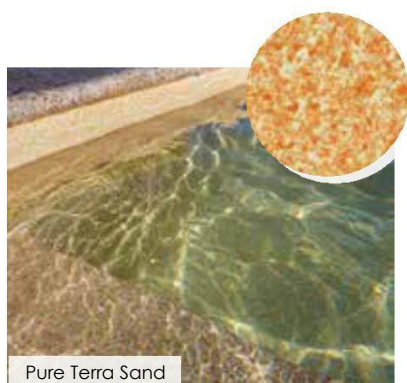

Pure Terra Sand



Pure Ocean Grey

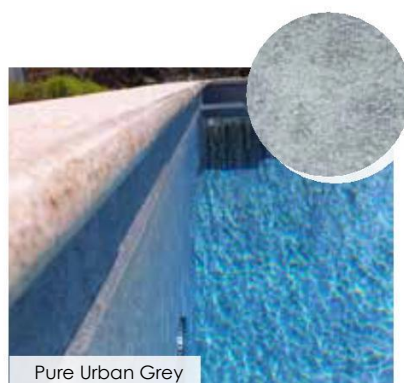

Pure Urban Grey



Pure Mountain Blue



Pure Sand Stone



Pure Indian Marble

Šifra/code	Membrana		Cena/price m ²
	Rolna debljine 1,8 mm x širina 1,65 m x dužina 21 m - 32m ² Roll thickness 1,8 mm x width 1,65 m x length 21 m - 32 m ²		
1050600	Elbtal PURE TERRA SAND		47,90 €
1050601	Elbtal PURE OCEAN GREY		47,90 €
1050558	Elbtal PURE URBAN GREY		47,90 €
1050559	Elbtal PURE MOUNTAIN BLUE		47,90 €
1050568	Elbtal PURE SAND STONE		47,90 €
1050569	Elbtal PURE INDIAN MARBLE		47,90 €



ELBTAL ISLAND DREAMS - MEMBRANA ZA OBLAGANJE OJAČANA ELBTAL ISLAND DREAMS - REINFORCED MEMBRANE



Otporna na UV zrake, otporna na hladnoću i atmosferskim uticajima, lako se vari, bez teških i fizioloških metala, besprekorna, po standardima EN 71/3, otporna na uobičajene hemijske proizvode za tretman vode u bazenima. Island Dreams se može koristiti i kao protivklizna membrana sa nivoom zaštite C.

Savršeno prijanja i može se kombinovati sa standard membranama kao i tečnom PVC u crnoj boji (1050626), sivoj (1050625), pesak(1050623) i beloj (1050622).

The coating Elbtal island dreams, is a PVC membrane reinforced with 2 mm thick fiber. By embossing the structure the texture recalls the most famous sandy beaches : Fiji, Aruba, Santorini and Maui. TECHNICAL FEATURES: UV-resistant, cold and weather resistant, good weldability, free of heavy and physiological metals unobjectionable according to EN 71/3, resistant to all usual chemicals for water treatment in swimming pools. Island Dreams can also be used as an anti-slip membrane serving the anti-slip protection level C. It fits perfectly and can be combined with standard membranes as well as with liquid PVC in colours black (1050626), grey (1050625), sand (1050623) and white (1050622).



Šifra/ code	Membrana		cena/ price m2
	Rolna debljine 2 mm x širina 1,60 m x dužina 20m - 32m2 Roll thickness 2 mm x width 1,60 m x length 20 m - 32 m2		
1050847	Elbtal ISLAND DREAMS - Fiji		57,10 €
1050848	Elbtal ISLAND DREAMS - Aruba		57,10 €
1050849	Elbtal ISLAND DREAMS - Santorini		57,10 €
1050877	Elbtal ISLAND DREAMS - Maui		57,10 €

**ELBTAL PEARL160/100 - MEMBRANA U PVC ARMIRANOM ŠTAMPANA
PRINTED AND LAQUERED PVC PEARL**

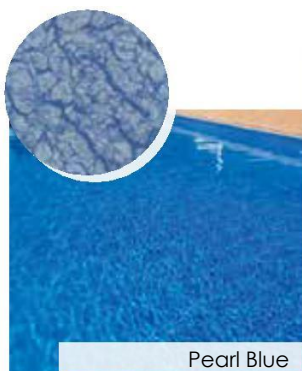
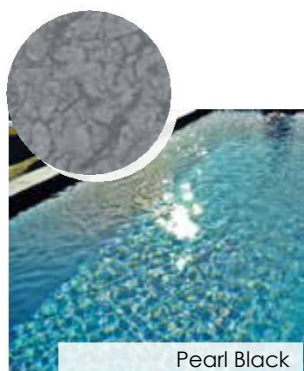

Šifra/code stampato h1,65x25m	Opis/description Rolna debljine 2 mm x širina 1,60 m x dužina 20m - 32m2 Roll thickness 2 mm x width 1,60 m x lenght 20 m - 32 m2 MEMBRANA ŠTAMPANA LAKIRANA EFEKAT SEDEFA / PEARL EFFECT	cena/price m2 h1,65x25m
1050823	Elbtal nero perla / pearl black	51,20 €
1050824	Elbtal blu perla / pearl blue	51,20 €
1050825	Elbtal bianco perla / pearl white	51,20 €
1050832	Elbtal silver Lagoon / silver Lagoon	51,20 €

PVC TEČNI ZA ELBTAL / LIQUID PVC FOR ELBTAL

Šifra/ code	Opis/description	Limenka / Can	cena/ price
1050620	Pvc tečni Elbtal sv.plava / light blue liquid pvc	limenka 1 kg	44,20 €
1050621	Pvc tečni Elbtal plava / blue liquid pvc	limenka 1 kg	44,20 €
1050622	Pvc tečni Elbtal beli / white liquid pvc	limenka 1 kg	44,20 €
1050625	Pvc tečni Elbtal sivi / grey liquid pvc	limenka 1 kg	44,20 €
1050624	Pvc tečni Elbtal zelena Caraibi / green liquid pvc	limenka 1 kg	44,20 €
1050623	Pvc tečni Elbtal pesak / sand liquid pvc	limenka 1 kg	44,20 €
1050626	Pvc tečni Elbtal crna / black liquid pvc	limenka 1 kg	44,20 €
1050650	Pvc tečni Elbtal sivo antracite / dark grey liquid pvc	limenka 1 kg	44,20 €
1050651	Pvc tečni Elbtal providna / transparent liquid pvc	limenka 1 kg	44,20 €
1050534	Bočica + čep za aplikaciju tečnog PVC / bottle + cap for the application of liquid PVC		12,10 €

**ELBTAL WBT - MEMBRANA ZA OBLAGANJE ZA MALA JEZERA
ELBTAL WBT - MEMBRANE FOR ARTIFICIAL LAKE**

ELBTAL WBT membrana za oblaganje malih jezera, vodenih veštačkih tokova, pogodnih za ribe. Crna boja, debljine 1,00 mm, visine 2,00 m, rolna od 20 metara.

ELBTAL WBT membrane for ponds, artificial streams, suitable for fishes. Colour black, thickness 1.0 mm, height 2.00 m, 20 meter roll.

Šifra/ code	Opis/description	Cena/ price € / m2
1050841	ELBTAL WBT nero/ black	10,80 €

LINERLOCK PROFIL ZAVRŠNE OBRADE / LINER FINISHING PROFILE LINERLOCK

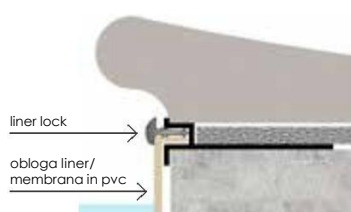

Šifra/ code	Opis/description		cena/ price
1050410	LINERLOCK profil završne obrade liner beli/ Linerlock profile of finishing liner white	Po rolni od 50m/roll 50 m	66,10 €
1050470	LINERLOCK profil završne obrade liner sv.plavi/ Linerlock profile of finishing liner light blue	Po rolni od 50m/roll 50 m	66,10 €
1050471	LINERLOCK profil završne obrade liner plavi/ Linerlock profile of finishing liner blue	Po rolni od 50m/roll 50 m	66,10 €
1050473	LINERLOCK profil završne obrade liner pesak/ Linerlock profile of finishing liner sand	Po rolni od 50m/roll 50 m	66,10 €
1050474	LINERLOCK profil završne obrade liner sivi/ Linerlock profile of finishing liner grey	Po rolni od 50m/roll 50 m	66,10 €
1050475	LINERLOCK profil završne obrade liner sivi antracite/ Linerlock profile of finishing liner dark grey	Po rolni od 50m/roll 50 m	66,10 €
1050476	LINERLOCK profil završne obrade liner crni/ Linerlock profile of finishing liner black	Po rolni od 50m/roll 50 m	94,70 €

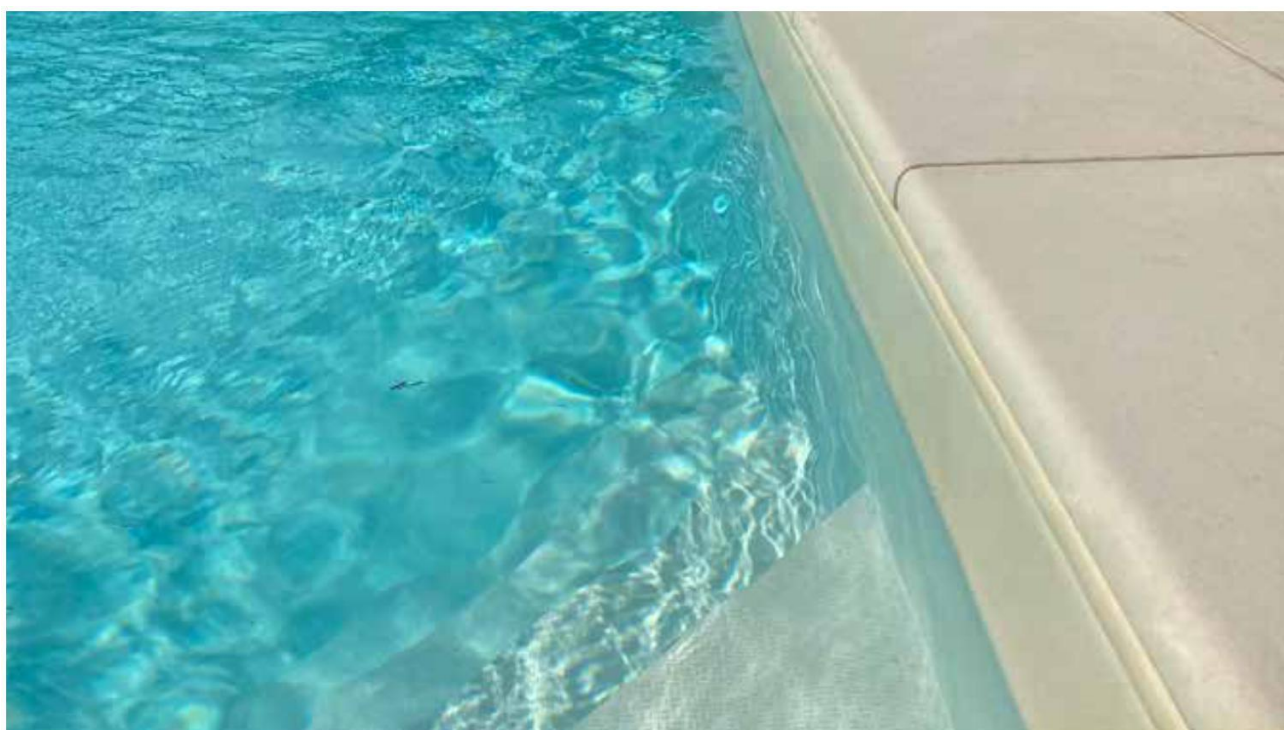

VOĐICA ZA KAČENJE ZA POSTAVLJANJE LAJNERA / COUPLING GUIDE TO FIX LINER

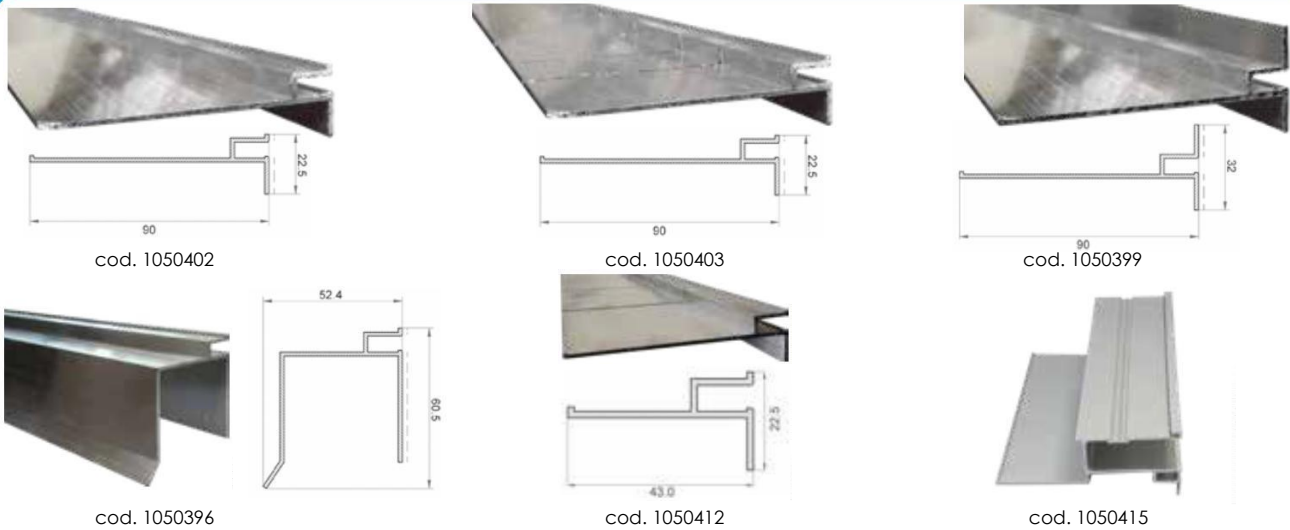

Šifra / code	Opis/description		Cena/ price
1050412	Aluminijum vođica 43 mm prava, šipke od 3 m / straight aluminum guide 43 mm, bars 3 m	al m	5,50 €
1050413	Aluminijum vođica 43 mm slobodnog oblika, šipke od 3 m / free-shape aluminum guide 43 mm, bars 3 m	al m	7,50 €
1050402	Aluminijum vođica 100 mm diritta, šipke od 3 m / straight aluminum guide 100 mm, bars 3 m	al m	8,80 €
1050403	Aluminijum vođica 100 mm slobodnog oblika, šipke od 3 m / free-shape aluminum guide 100 mm, bars 3 m	al m	10,80 €
1050400	Aluminijum vođica 100 mm prava, šipke od 1,5 m / straight aluminum guide 100 mm, bars 1,5 m	al m	9,70 €
1050401	Aluminijum vođica 100 mm slobodnog oblika, šipke od 1,5 m / free-shape aluminum guide 100 mm, bars 1,5 m	al m	11,70 €
1050399	Aluminijum vođica 100 mm prava sa krilcem, šipke od 3 m / straight aluminum guide 100 mm with fin bars 3 m	al m	9,40 €
1050398	Aluminijum vođica 100 mm slobodnog oblika +krilce, šipke od 3 m / free-shape aluminum guide 100 mm with fin, bars 3 m	al m	11,40 €
1050396	Aluminijum vođica prava U, šipke od 3 m / U straight aluminum guide, bars 3 m	al m	11,20 €
1050397	Aluminijum vođica slobodnog oblika U, šipke od 3 m / U free-shape aluminum guide, bars 3 m	al m	13,20 €
1050415	Vođica ispod spuštene ivice od aluminijuma za Safety Cover / Aluminum underboard guide for Safety Cover	al m	23,00 €

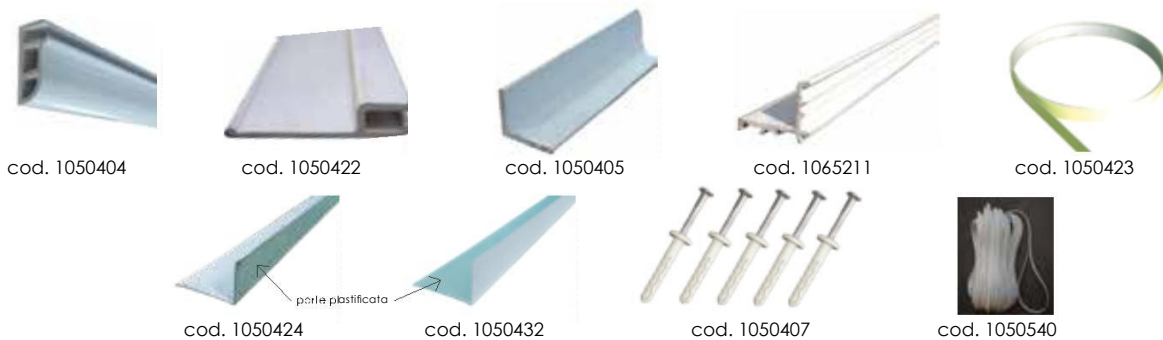

Šifra / code	Opis/description	Dimenzije/dimensions		cena/ price
1050404	Vodica PVC, ispod ivice / pvc guide, under edge	32x8 mm - šipke/bars 2,00 m	al m	9,20 €
1050422	Vodica PVC bela prava / white straight pvc guide	50 mm - šipke/bars 2,50 m	al m	5,60 €
1050405	Vodica PVC a L za preliv / L pvc guide, for overflow	25x25mm-sp.2mm-šipke/bars2,50m	al m	7,40 €
1065211	Profil kao oslonac rešetke od PVC / support grid in pvc	25x35 mm - šipke/bars 2,50 m	al m	11,20 €
1050423	aluminium vodica pljosnata plastificirana za zid / flat aluminum plasticized guide	30 mm - šipke/bars 2,00 m	al m	4,70 €
1050424	Pljosnata alum.vodica L plastificirana spolja za zid / flat aluminum plasticized internalguide	30x20 mm -šipke/bars 2,00 m	al m	7,90 €
1050432	Aluminijumska pljosnata vodica L iznutra plastificirana za zid / flat aluminum plasticized internalguide	30x20 mm - šipke/bars 2,00 m		7,90 €
1050433	Vodica PVC polaganje cerade plave boje / blue sheet-laying pvc guide	50 mm - sp. 2 mm -šipke/bars 1,50 m		7,50 €
1050407	Podloške za brzo fiksiranje pocinkovani 6/40 -	kutija/box 200 pz		60,00 €
1050409	Podloške za brzo fiksiranje inox 6/40 / inox quick fixing anchors 6/40- box 200 pieces	kutija/box 200 kom		111,10 €
1050540	zatezna ivica pvc bela na var -rolna 50m / pvc white borderto be welded-roll50m	9x3 mm - po m /per meter		1,30 €

PROIZVODI ZA LINER / PRODUCTS FOR LINER

BIOTEX

Zaštitna prostirka u TNT.

Protective mattress non-woven fabric.

ALKORPLUS 81006

TNT polipropilene sa tretmanom protiv-mikroorganizama.

Non-woven polypropylene fabric with anti-microbe treatment.

APC system

Patentirani sistem štiti kritični međuprostor između uglova bazena od razvoja i širenja mikroorganizama. Proizveden od presovanih vlakana, l'APC prima biocidni preventivni tretman.

Patented system protects the critical range between the angles of a swimming pool by the development and proliferation of micro-organisms. Made from compressed fibers, the APC system receives a biocide treatment.



ŠIFRA/ code	Opis/description	Cena/ price
1050416	Rolna zaštitne prostirke 1,20x30 m Roll protective mattress	204,10 €
1050417	Rolna zaštitne prostirke 1,60x30 m Roll protective mattress	272,20 €
1050418	Rolna zaštitne prostirke 2,00x30 m Roll protective mattress	340,20 €



Šifra/ code	Opis/description			Cena/ price
1050428	Rolna zaštitne prostirke Alkorplus Roll protective mattress	1,50x50 m	al rotolo	888,60 €
1050429	Rolna zaštitne prostirke Alkorplus Roll protective mattress	2,00x50 m	al rotolo	1.184,70 €

Šifra/ code	Opis/description	cena/ price
1050420	"APC system" Filcovani ugao, sa biocidnim tretmanom lot od 18 dužina od 2 m Corner in felt, biocide treatment, lot of 18 lengths from 2 m	7,40 €



Šifra/ code	Opis/description	Cena/ price
	LEPAK "BIOCOL" PROTIV BAKTERIJA ZA FILC/ "BIOCOL" FOR FELT	
1050421	Limenka od 5 kg lepka Biocol / ar of 5 kg of glue Biocol	100,30 €

PROSTIRKA PE PENASTI MONVISO SA LEPKOM FOAM PE MATTRESS MONVISO WITH ADHESIVE

Polietilene penasti mrežast zatvorene ćelije tipa TR 35 kg/m³, debljine 5 mm, bele boje.

Lepljivi sloj PE u podlošci. Rolna od 30 m h x 1,50 m.

Cross-linked foam polyethylene with closed cell TR 35 kg/m³, thickness 5 mm, colour white.

PE film adhesive support. Roll of 30 mxh1.50 m.



Šifra / code	Opis /description	Cena/ price
1050430	Rolna Monviso, prostirka polietilene penasti sa lepkom i slojem PE h 1,50 x 30 m rolna	587,50 €

USISIVAČ Q-VAC III ZA POLAGANJE LAJNERA Q-VAC III ASPIRATOR TO FIX LINER



Tih, sistemhlađenja motora, priključak usisa od 10 cm, rukohvat za transport.

Silent cooling system of the engine, aspiration connect of 10 cm, carrying handle.

Šifra/code	Opis/description	cena/price
1050431	Usisivač Liner Q-VAC III / Liner aspirator	1.550,00 €

EKSPANZIONI EKSERI / EXPANSION BOLTS



Šifra/code	Opis/description	Kutija/box	cena/price
1050539	Ekspanzioni ekseri mm.15 / Blots 15 mm, box 100 pieces	100 kom	53,30 €
1050570	Ekspanzioni ekseri mm.25 / Blots 25 mm, box 100 pieces	100 kom	61,40 €

RASTVARAČ I LEPAK / SOLVENT AND GLUE



Šifra/code	Opis/description	Pakovanje/package	Cena/price
1050534	Bočica + čep za aplikaciju tečnog PVC Bottle + cap for the application of liquid PVC		12,10 €
1050767	Lepak za membranu ALKORGLUE Glue for membrane ALKORGLUE	5 L	185,30 €
1050761	Kontakt lepak za membranu ALKORGLUE, pogodna za izradu detalja Contact glue for membrane ALKORGLUE, suitable for the execution of the details	5 L	199,60 €
1050770	Kontakt lepak za membranu ALKORGLUE, pogodna za izradu detalja Contact glue for membrane ALKORGLUE, suitable for the execution of the details	20 L	606,90 €

MEKSIKANSKI / MEXICANS



Šifra/code	Opis/description	cena/price
1050521	Meksikanci protiv prolivanja PVC 80 mm / Mexican anti regurgitation in pvc 80 mm	22,50 €
1050522	Messicani protiv prolivanja PVC 100 mm / Mexican anti regurgitation in pvc 100 mm	25,30 €
1050523	Messicani protiv prolivanja in PVC 125 mm / Mexican anti regurgitation in pvc 125 mm	30,20 €

ZAŠTITNA SREDSTVA ZA INSTALACIJU MEMBRANA I LAJNERA



PROTECT LINER: smanjuje razmnožavanje mikroorganizama ispod obloga. Preventivno se aplicira na zidove bazena, pre postavljanja lajnera ili PVC membrane, raspršujući ga. 5 l Protect liner omogućavaju tretman cca 100 m².

It reduces the growth of microorganisms in the coatings. Applied in advance on the walls of the pool, before laying the liner or PVC membrane, pulverizing. 5 l of Protect Liner treat about 100 square meters.

ALKORPLUS SANITIZED: idealni proizvod za prevenciju širenja mikroorganizama i gljivica u prostoru između zida bazena i membrane Alkorplan.

The ideal product to prevent the proliferation of microorganisms and fungi in the area between the pool wall and membrane Alkorplan.

Šifra/code	Opis/description	Pakovanje/package	cena/price
1050451	Protect Liner	5 L	63,70 €
1050762	Alkorplus Sanitized	1 L	77,00 €

LEISTER

LEISTER TRIAC ST je aparat za varenje toplim vazduhom, neophodan za polaganje obloga. Od velike pomoći u hidrauličnim radovima, za ojačanje cevi PVC ili popravku neispravnog lepljenja .

Leister Triac ST is a hot air welding equipment, essential for the laying of membrane. It helps you in plumbing for PVC pipe or repair a defective bonding.



cod. 1050630



cod. 1050642



cod. 1050684



cod. 1050686



cod. 1050633



cod. 1050648

cod. 1050691



cod. 1050649

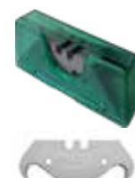

cod. 1050653



cod. 1050654

Šifra/ code	Opis/description	Cena/ price
1050630	LEISTER TRIAC ST 230V-1600 W za ugradnu mlaznicu LEISTER TRIAC ST 230V-1600 W for plug-in nozzle	948,60 €
1050642	LEISTER TRIAC AT 230V-1600 W c/indikator digitalni temperature za ugradnu mlaznicu LEISTER TRIAC AT 230V-1600 W c/digital temperature display for plug nozzle	1.267,20 €
1050684	Uniroof 300, 230V/3450W, 30 mm, EU PLUG	9.711,60 €
1050686	Hot Jet S 230V/460W sa utikačem Euro	1.329,90 €
1050633	Valjak pritiska 22D - 40 mm Pressure roller 22D - 40 mm	136,10 €
1050648	Valjak pritiska 21 Pressure roller 21	81,70 €
1050691	Kuka za proveru vara Hook for welding tests	51,90 €
1050649	Leister cutter sa 2 različita oblika sečiva Leister cutter with two different blade shapes	98,20 €
1050653	Kukičasto sečivo za cutter Leister - kutija od 10 sečiva Hooked blade for Leister cutter - box with 10 blades	20,30 €
1050654	Sečivo pravo za cutter Leister - kutija od 10 sečiva Straight-edge blade for Leister cutter - box with 10 blades	14,60 €

LEISTER

LEISTER TRIAC AT raspolaže ekranom sa digitalnim prikazivanjem temperature. Termička sonda velike otpornosti garantujući regulisanje temperature na precizan način. Mogućnost regulisanja dotok vazduha na nezavisan način. Maksimalna čistoća i zaštita.

Leister Triac AT is equipped with digital display of the temperature. The sensor ends upstream of the resistance, that guarantees adjusted temperatures in a precise way. Possibility to adjust the air flow independently. Maximum cleaning and protection.



cod. 1050634



cod. 1050635



cod. 1050637



cod. 1050647



cod. 1050687



cod. 1050688



cod. 1050689



cod. 1050690



cod. 1050685



cod. 1050692



cod. 1050693

Šifra / code	Opis /description	Cena/price
1050634	Mlaznica 30 A3- 20 mm curvato 60 Curved nozzle	106,30 €
1050635	Mlaznica 30 A1- 20 mm Nozzle	106,30 €
1050637	Mlaznica brzi var 30B8 - 12 mm Speed welding nozzle	177,90 €
1050647	Mlaznica 31 A - 5 mm okrugla aplicira se spojem Round push-fit nozzle	107,70 €
1050687	Mlaznica sa širokim prorezom 20 mm, ugradljiva Wide slot nozzle 20 mm, insertable	106,30 €
1050688	Mlaznica sa širokim prorezom 20 mm, sa uglom Wide slot nozzle 20 mm with angle	223,20 €
1050689	Mlaznica za cev ø 5mm na spajanje Tubular nozzle	106,30 €
1050690	Mlaznica brzog vara za traku od 8mm na cevnoj mlaznici Speed welding nozzle	269,70 €
1050693	Pritiskač cerade "Kehlfix" za unutrašnji ugao	160,50 €
1050685	Produžni kabl pur 3x2,5 mm ² L=15m Extension cable	217,40 €
1050692	Univerzalne makaze 260 mm Utility scissors	67,00 €

SPOLJNI PODOVI I IVICE BAZENA OUTDOOR FLOORS AND POOL EDGES



Ivice i pločice bazena daju eleganciju i primesu ličnoga. Rafinisana i brižljiva za detalje, oblaganje patosa na realan način reprodukuje karakteristike prirodnog kamena sa jedinstvenim i čistim izgledom, izbegavajući da se zagreva sa suncem i leđi pri hladnoći.

The edges and tiles for the pool lend elegance and a touch of personality to the pool. Flooring refined and accurate in detail, realistically representing the characteristics of natural stone with a clean and unique, avoiding heat up with the sun and freeze in the cold.

IVICA BAZENA ROSALIND PROTIVKLIZNA / ROSALIND POOL EDGE ANTI-SLIP



Ivica od betonskog peskiranog aglomerata
50 x 31 x debljine 3 cm
Agglomerated concrete edge pool 50 x
31 x thickness 3 cm

**NA RASPOLAGANJU / AVAILABLE
IN**

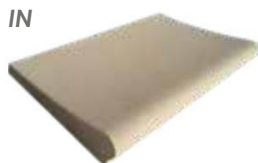

pesak/sand

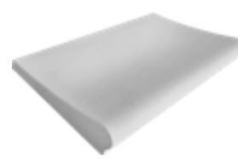

bela/white

Šifra pesak/ code sand	Šifra belo/ code white	Opis/description	cena pesak/ price sand	Cena belo/ price white
1020540	1020545	Ivica Rosalind prava sekcija 50 x 31 / Straight section 50 x 31	26,30 €	26,30 €
1020541	1020546	Ivica Rosalind sekcija pravi ugao / 90° section	27,80 €	27,80 €
1020542	1020547	Ivica Rosalind sekcija unutrašnji obrnuti ugao / Internal reverse angle	27,80 €	27,80 €
1020543	1020548	Ivica Rosalind sekcija unutrašnji ugao scala Romana / Internal angle Roman ladder	65,20 €	65,20 €
1020722	1020710	Ivica Rosalind Radijus sekcija / Radius section	43,20 €	43,20 €
1020737	1020734	Ivica Rosalind sekcija obrnutog radijusa / Radius reverse section	43,20 €	43,20 €
1020517	1020512	Set ivica Rosalind scala Romana 2,00 m / Kit with Roman ladder 2,00 m	346,40 €	346,40 €
1020513	1020514	Set ivica Rosalind scala Romana 2,50 m / Kit with Roman ladder 2,50 m	389,60 €	389,60 €
1020515	1020516	Set ivica Rosalind scala Romana 3,00 m / Kit with Roman ladder 3,00 m	519,20 €	519,20 €
1020524	1020522	Set ivica Rosalind scala Opera 1,50 m / Kit with Opera ladder 1,50 m radius	617,20 €	617,20 €

Ivica Rosalind **PESAK** raspoloživa u sledećim RADIJUSIMA: / *Rosalind sand radius section*

Šifra	1020722	1020723	1020724	1020725	1020726	1020727	1020728	1020729	1020730	1020731	1020733
Radius	0,75	1,00	1,40	1,50	1,75	2,00	2,50	3,00	3,50	4,00	8,00

Ivica Rosalind **BELA** raspoloživa u sledećim radijusima: / *Rosalind sand radius section*

Šifra	1020710	1020711	1020712	1020713	1020714	1020715	1020716	1020717	1020718	1020719	1020721
Radius	0,75	1,00	1,40	1,50	1,75	2,00	2,50	3,00	3,50	4,00	8,00

Ivica Rosalind **PESAK** raspoloživa u sledećim OBRNUTIM RADIJUSIMA: / *Rosalind sand radius section*

Šifra	1020737	1020738	1020739
Radius [m]	2,00	3,00	3,50

Ivica Rosalind **BELA** raspoloživa u sledećim OBRNUTIM RADIJUSIMA: / *Rosalind white radius section*

Šifra	1020734	1020735	1020736
Radius [m]	2,00	3,00	3,50



IVICA BAZENA PESKIRANA/ SANDBLASTED POOL EDGE



Ivica od betonskog peskiranog aglomerata 60 x 31,5 cm, debljine 3,0 cm.
Rough agglomerated concrete grit 60 x 31,5 cm, thickness 3,0 cm.



belo/white

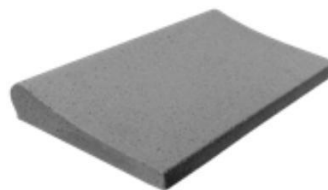

sivo/grey

Šifra belo/code white	Šifra sivo/code grey	Opis/description	Cena belo/price white	Cena sivo/price grey
1020015	1020870	Peskirana ivica pravi profil / Sandblasted streigh section	31,90 €	37,40 €
1020016	1020871	Peskirana ivica pravougaoni profil / Sandblasted 90° section	34,30 €	37,40 €
1020018	1020872	Peskirana ivica profil unutarnji obrnuti ugao / Sandblasted internal angle reverse	34,30 €	37,40 €
1020858	1020873	Peskirana ivica unutrašnji dx ugao scala romana radijus 1m Sandblasted internal right angle roman ladder - r1 m	83,70 €	101,20 €
1020859	1020874	Peskirana ivica unutarnji lx ugao scala romana radijus 1m Sandblasted internal left angle roman ladder - r1 m	83,70 €	101,20 €
1020860	1020875	Peskirana ivica unutrašnji dx ugao sc. romana radijus 1,5m Sandblasted internal right angle roman ladder -r1,5m	83,70 €	101,20 €
1020861	1020876	Peskirana ivica unutrašnji lx interno scala romana raggio 1,5m Sandblasted internal left angle roman ladder - r1,5m	83,70 €	101,20 €
1020775	1020880	Peskirana ivica profil radijus / Sandblasted radius section	35,50 €	40,80 €
1020792	1020896	Peskirana ivica profil obrnuti radijus / Sandblasted reverse radius section	35,50 €	40,80 €
1020506	1020877	Set peskirana ivica scala Romana 2,00 m / Kit for Roman ladder 2,00 m	309,40 €	365,60 €
1020503	1020878	Set peskirana ivica scala Romana 2,50 m / Kit for Roman ladder 2,50 m	344,90 €	406,40 €
1020505	1020879	Set peskirana ivica scala Romana 3,00 m / Kit for Roman ladder 3,00 m	302,70 €	488,00 €
1020519	1020904	Set peskirana ivica scala Opera radijus 1,50 m / Kit ladder 1,50 m radius	388,10 €	442,00 €

Ivica BELA PESKIRANA raspoloživa u sledećim RADIJUSIMA: / White sandblasted radius section

Codice	1020775	1020776	1020777	1020778	1020779	1020780	1020781	1020782	1020783	1020784	1020785	1020786	1020788	1020789	1020790	1020791
Radijus [m]	0,65	0,80	1,00	1,25	1,40	1,50	1,75	2,00	2,50	3,00	3,50	4,00	5,00	6,25	7,00	8,50

Ivica BELA PESKIRANA raspoloživa u sledećim obrnutim radijusima: / White sandblasted reverse radius section:

Codice	1020792	1020793	1020794	1020795	1020796	1020797	1020798	1020799
Radijus [m]	1,25	1,50	2,00	3,00	3,50	4,00	5,50	6,50

Ivica SIVA PESKIRANA raspoloživa u sledećim RADIJUSIMA: / Grey sandblasted radius section:

Šifra	1020880	1020881	1020882	1020883	1020884	1020885	1020886	1020887	1020888	1020889	1020890	1020891	1020892	1020893	1020894	1020895
Radijus [m]	0,65	0,80	1,00	1,25	1,40	1,50	1,75	2,00	2,50	3,00	3,50	4,00	5,00	6,25	7,00	8,50

Ivica SIVA PESKIRANA raspoloživa u sledećim OBRNUTIM RADIJUSIMA: / Grey sandblasted reverse radius section:

Šifra	1020896	1020897	1020898	1020899	1020900	1020901	1020902	1020903
Radijus [m]	1,25	1,50	2,00	3,00	3,50	4,00	5,50	6,50

PROTIVKLIZNI TRETMAN / ANTI-SLIP TREATMENT



Protivklizni tretman, rešava problem klizavosti prouzrokovan vodom. Ne remeti estetski izgled tretirane površine, ne formira površinske slojeve, dejstvuje direktno na materijal kreirajući mikroporoznost takvu da omogućuje protivkliznost u prisustvu vode. Potrošnja : 5 lt za 24 mtl. površine.

Anti-slip treatment, solves the problem of sliding caused by water. Does not alter the aesthetics of the treated surface, does not form a surface film, acts directly on the material by creating a microporosity to allow for the necessary anti-slip in the presence of water. Consumption: 5 litres for 24 mtl. of surface.

Šifra/code	Opis/description	Cena/price
9010036	Protivklizni proizvod 5 lt - non-slip product	162,10 €

IVICA BAZENA ESPACE TRADICIONALNI / ESPACE STANDARD POOL EDGE



Espace pravi 50 x 33 cm
Straight section 50 x 33 cm



Pravi ugao
90° section



Spoljni ugao 90°
External angle 90°



Ugao ist. scala
romana 90°
External angle 90°



Sekcija sa radijusom
Radius section

Šifra sabbia	Opis	Mere [cm]	cena/price
TRADICIONALNA IVICA ESPACE debljine 2,7 cm / STANDARD ESPACE EDGE thickness 2,7 cm			
1020070	Ivica Espace prava / Straight section	50 x 33	Po kom. 26,20 €
1020072	Ivica Espace pravi ugao / 90° section	38 x 38	Po kom. 81,80 €
1020074	Ivica Espace sa radijus 1,50 m / Radius section 1,50 m	34,8 est. x 28,5 int	po kom. 50,70 €
1020078	Ivica Espace spoljni pravi ugao 90° / External angle 90°	33 x 33	Po kom. 81,80 €
1020092	Ivica Espace spoljni desni ugao r 1,50 / External right angle r 1,50	33 x 28,5	Po kom. 98,60 €
1020093	Ivica Espace spoljni levi ugao r 1,50 / External left angle r 1,50	33 x 28,5	Po kom. 98,60 €
1021361	Ivica bordo Espace scala Romana radijus 1,50 / Edges kit for Roman stair radius 1,50	-	set 907,00 €

IVICA BAZENA ESPACE RAVNI / ESPACE FLAT POOL EDGE



Espace pravi ravni 50x33 cm
Straight section 50x33 cm

RASPOLOŽIV / AVAILABLE IN



sabbia / sand grigio / grey bianco / white



Pravi ugao 90° prav i obrnut
90° section



Radijus profil
Radius section



Spoljni ugao scala romana dx
External right angle

Šifra sabbia	Šifra grigio	Codice bianco		Mere [cm]	cena
IVICA RAVNA ESPACE debljine 3,4 cm / ESPACE FLAT EDGE thickness 3,4 cm					
1020089	1020130	1020094	Ivica Espace prava ravna / Straight flat section	50 x 33	Po kom. 31,40 €
1020097	1020131	1020106	Ivica Espace ravna pravi ugao / 90° section	33 x 33	Po kom. 81,50 €
1020102	1020138	1020107	Ivica Espace ravna spoljni pravi ugao 90° / External angle 90°	33 x 33	Po kom. 81,50 €
1020116	1020133	1020122	Ivica Espace ravna radijus 1,20 m / Radius section 1,20 m	46,9 est. x 36,7 int	Po kom. 56,30 €
1020600	1020134	1020601	Ivica Espace ravna radijus 1,50 m / Radius section 1,50 m	34,8 est. x 28,5 int	Po kom. 56,30 €
1020095	1020135	1020108	Ivica Espace ravna radijus 2,50 m / Radius section 2,50	43,4 est. x 38,3 int	Po kom. 56,30 €
1020183	1020187	1020191	Ivica Espace ravna spoljni desni ugao r1,50 / External right ang r1,50	33 x 28,5	Po kom. 103,00 €
1020184	1020188	1020192	Ivica Espace ravna spoljni levi ugao r1,50 / External left ang r 1,50	33 x 28,5	Po kom. 103,00 €
1020508	1020510	1020193	Set ivica Espace ravna scala Romana radijus 1,50 Edges kit for Roman stair radius 1,50		set 994,20 €

PLOČICE I IVICE ESPACE / ESPACE TILES AND EDGE



SPOLJNI PESKIRANI AGLOMERAT, protivklizni
Rough agglomerated for outdoor, antislip

NA RASPOLAGANJU / AVAILABLE IN

-  pesak
sand
-  bela
white
-  siva
ne tradicionalna ivica
grey
no standard edge

PLOČICE / TILES

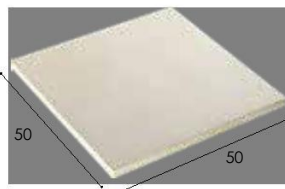

IVICE BAZENA / POOL EDGE

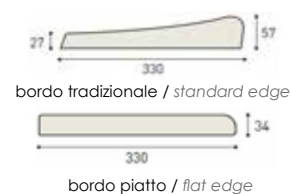

Šifra pesak/ Code sand	Šifra sivo/ Code grey	Šifra belo/ Code white	Opis	Mere measures [cm]	cena/ price
PLOČICE ESPACE debljine 2,5 cm / ESPACE TILES thickness 2,5 cm					
1020666	1020668	1020700	Pločica Espace / Espace tiles	50 x 50 a m2	69,30 €
1020663	1020665	1020862	Pločica Espace / Espace tiles	50 x 50 a bancale 9 m2	573,00 €

PLOČICE I IVICA CASTELLANE / CASTELLANE TILES AND EDGE



Aglomerat spoljni i površina nepravilna
 PLOČICE CASTELLANE: debljine 2,5 cm
 IVICA CASTELLANE: debljina 3,3 cm

Agglomerated for outdoor, irregular surface
 Castellane tiles: thickness 2,5cm
 Castellane edge: thickness 3,3 cm

NA RASPOLAGANJU / AVAILABLE IN



pesak / sand



sivo / grey

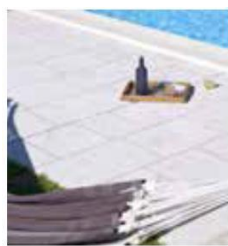

Šifra pesak	Šifra siva	Opis	Mere [cm]		Cena/price
1020849	1020699	Pločica Castellane Opus Castellane tiles	42x28 - 42x42 - 42x56	Po paleti 8,5 mq	816,70 €
1020660	1020662	Pločica Castellane Opus	42x28 - 42x42 - 42x56	po m2	104,60 €
1020160	1020393	Ivica/stepenik Castellane pravi profil 49x33 cm Edge/step straight section 49x33 cm		po kom.	54,20 €
1020161	1020394	Ivica Castellane profil pravi ugao 49x49 cm / 90° section 49x49 cm		Po kom.	110,90 €
1020162	1020395	Ivica Castellane radijalni profil 1,50 m / Radius sec- tion 1,50 m		Po kom.	72,70 €
1020164	1020397	Ivica Castellane profil spoljni ugao 90° / External angle 90°		Po kom.	140,20 €



Stepenik profil pravi 49x33 cm
Straight section 49x33 cm



Pravi ugao
90° section



Profil radijus 1,50 m
Radius sections 1,50 m



Spoljni ugao 90°
External angle 90°

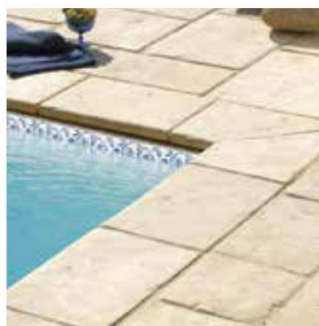
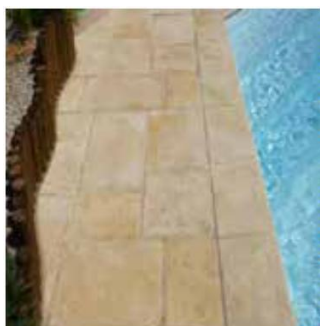

DECKING: MEMBRANA ZA OBLAGANJE PODA BAZENA DECKING: MEMBRANE FOR POOL FLOORING

NEW

Armirana membrana od fleksibilnog PVC, namenski dizajnirana za oblaganje površina zona oko bazena, vodo parkova, svlačionica i tuš zona. Pogodna za oblaganje podova iznutra i spolja, predviđena i za novu izgradnju kao i za obnovu postojećih podova. Polaže se na betonskim površinama, pločicama ili drvetu, formirajući kontinuirani patos, potpuno nepromočiv sa sigurnosnim protivkliznim finišom, testirana secondo la norma EN 1 4041

1 Zaštita protiv fleka, habanja i UV zraka. Sadrži usporavajuće aditive plamena daudovolji i prevaziđe zahteve.

Debljina 2 mm, širina 1,65 m, dužina 21 m.

Flexible PVC reinforced membrane specially designed to cover surfaces of areas around swimming pools, water parks, locker rooms and shower areas. Suitable for indoor and outdoor flooring, designed for both new construction and renovation of existing flooring. Installs on concrete, tile or wood surfaces, forming a continuous, totally waterproof floor with non-slip safety finish, tested to EN 14041. Protection against stains, abrasion and UV rays. Contains flame retardant additives to meet or exceed requirements. Thickness 2 mm, width 1.65 m, length 21 m.



Svetlo siva/Light grey



Pesak/Sand



Siva/Grey



Šifra/code	Opis/description	cena/price Po m ²
1050816	Alkorplan Decking svetlo siva/ light grey	68,90 €
1050817	Alkorplan Decking pesak / sand	68,90 €
1050818	Alkorplan Decking siva / grey	68,90 €

Šifra/code	Opis/description	cena/price
ACCESSORI/ACCESSORIES		
1050819	Zaštitna prostirka DECKING - rolna 1,50x50 m / DECKING protective mattress - roll 1,50x50 m	11,90 €
1050829	Alkorglue DECKING 20L – bez rastvarača / Alkorglue DECKING 20L - zero solvents	289,70 €
1050854	Traka povezivanje vara deblj.1,5mm - šir. cm 15 - rolna m.20 / Backing strip	408,60 €
1050760	Rastvarač THF limenka 1 L / THF solvent can 1 L	48,40 €

DOPUNSKI PROIZVODI/ COMPLEMENTARY PRODUCTS

VODOOTPORNI MALTER / WATERPROOF MORTAR

Malta impermeabilizzante idrofuga di giuntura disponibile nei colori bianco (per piastrelle colore sabbia), beige (per piastrelle colore aquitaine) e grigio (per piastrelle colore grigio). Preparazione : 5 litri d'acqua per sacco da 25 kg, mescolare fino ad ottenere una pasta omogenea.

Joint waterproofing mortar available in white (for sand tiles), beige (for aquitaine tiles) and grey (for gey tiles) colours. Preparation: 5 liters of water per 25 kg bag, mix until obtaining a homogeneous paste.

LEPLJIVI MALTER / ADHESIVE MORTAR

Malta adesiva idrofuga per l'incollaggio di pavimentazioni disponibile nel colore beige. Preparazione: da 5,75 a 6,25 litri d'acqua per sacco da 25 kg, impastare usando un miscelatore elettrico (bassa velocità).

Adhesive waterproof mortar for bonding of pavings available in beige colour. Preparation: from 5.75 to 6.25 liters of water per 25 kg bag, knead using an electric mixer (low speed).

GIPS COLORFILL / COLORFILL PLASTER

Profesionalna betonska fug masa za fugovanje podova i prekrivnih pločica, staklenih i od prirodnog kamena od 2 do 12 mm.

Potrošnja zaviso od veličine fuge. Na raspolaganju boje, crna, siva, led, slonova kost, krem, bež, pesak, tamno braon, braon, crvenoj, narandžastoj, ružičastoj, tamno crvenoj. Druge boje po zahtevu.

Professional cementitious joint sealing for grouting floors and ceramic coatings, vitreous and made of natural stone from 2 to 12 mm. Consumption in function of the size of the joint. Available in white, black, grey, ice, ivory, cream, beige, sand, brown, red, orange, pink, dark red. Other colours on request.

EP LASTIK

Malta elastica bicomponente per l'impermeabilizzazione e la protezione del cemento prima della posa di piastrelle e mosaici in piscina.

Si usa in due mani interponendo una armatura in rete di vetro da 160 gr/m². Adatto al trattamento delle superfici interne di piscine prima della successiva posa del rivestimento ceramico o vetroso. Consumo impermeabilizzante: 1,7-1,8 kg/m² per 1 mm di spessore. Per ottenere una impermeabilizzazione con tenuta di colonna d'acqua pari a 1 m è necessario uno spessore minimo di 2 mm.

Two-component elastic mortar for waterproofing and protecting cement before laying tiles and mosaics in the pool. It is used in two coats interposing a 160 gr/m² glass mesh reinforcement. Suitable for the treatment of the internal surfaces of swimming pools before the subsequent laying of the ceramic or glass coating. Waterproofing consumption: 1.7-1.8 kg/m² per 1 mm of thickness. A minimum thickness of 2 mm is required to achieve waterproofing with a water column of 1 m.

RASACOLL

Jednokomponentna glet masa u prahu za finalno gletovanje izolir panela od polistirena. Il proizvod se armira mrežicom od staklenog vlakna.

Pogodan za upotrebu u EPS strukturama. Potrošnja : 1,5 kg/m² za jedan mm debljine.

Monocomponent powder smoothing for the final smoothing insulating panels, made of polystyrene. The product is reinforced with fiber glass mesh. Adapt with EPS structures. Consumption: 1,5 kg/m² per 1 mm thickness.

MREŽA OD STAKLENOG VLAKNA / REINFORCEMENT FIBER MESH

100% od staklenog vlakna zbog svojih osobina preporučuje se za aplikaciju EP LASTIK. Preporučuje se za ojačanje membrane u postojećim betonskim strukturama. Širina mreže 4,5x5 mm - Gramaža 160 g/m²

100% in fiberglass for its characteristics is recommended for the application of EP LASTIK. Recommended for the reinforcement of membrane of existing concrete structures pools. Width 4,5x5 mm - weight 160 g/m²

TRAKA RL80S / STRIP RL80S

Samolepljiva zaptivna traka, sastavljena od viskoelastičnog sloja i presvučena TNT.

Self-adhesive sealant strip, composed of a viscoelastic layer and coated by non-woven fabric.

Codice/ code	Modello/model	Colore/color	Prezzo/ price
1020327	Vodootporni malter džak od 25 kg / Waterproof mortar 25 kg bag	beli white	77,20 €
1020319	Vodootporni malter džak od 25 kg / Waterproof mortar 25 kg bag	grigio grey	77,20 €
1020337	Vodootporni malter džak od 25 kg / Waterproof mortar 25 kg bag	beige beige	77,20 €
1020310	Lepljivi malter džak od 25 kg / Adhesive mortar 25 kg bag	beige beige	78,10 €
1020322	Gips Colorfill – džak od 5 Kg / Plaster- bag 5 kg	avorio ivory	18,00 €
1020318	Gips Colorfill – džak od 5 Kg / Plaster- bag 5 kg	grigio scuro dark grey	18,00 €
1020317	Vodonepropustivi EP LASTIK – vreća od 25 kg i kanta 7,5 l Waterproofing EP LASTIK - bag 25 kg, tank 7,5l		233,10 €
1020406	Glet masa RASACOLL – džak od 25 kg / RASACOLL - bag 25 kg		44,20 €
1020417	Mreža od staklenog vlakna - rotolo da 50 m ² (h1 x 50 m) Reinforcement fiber mesh - roll of 50 m ² - (h1x50m)		295,00 €
1020418	Samolepljiva zaptivna traka RL80S – rolna od 10m - kutija od 8 kom. Adhesive sealant strip RL80S roll of 10 m box 8 pieces		92,00 €



cod. 1020327



cod. 1020317

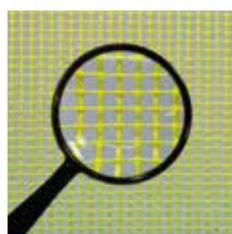

cod. 1020417



cod. 1020418



RED-DET: DETERDŽENT KONCENTRAT ODMAŠČIVAČ ZA SVE POVRŠINE

Deterdžent sa koncentrat razblaživom formulom u vodi , pogodan za dubinsko čišćenje bilo koje površine od tvrdih materijala, porcelanski gres, aglomerat smole, terakota, beton. RED-DET topi na efikasan način masne supstance ulja, prljavštinu zbog gaženja, atmosfersku prljavštinu, dimska zagađenja, ostatke prehrambenih supstanci. Deterdžent odmašćuje dubinski bez uticaja na površinu i ako je glatka, posebno je preporučljiv za mat površine/neobrađene .
 POTROŠNJA: 50 m² po 1 kg

DEGREASER CLEANER CONCENTRATED FOR ALL SURFACES

Concentrated detergent, dilutable in water, suitable for the deep cleaning of any surface in stone, porcelain stoneware, agglomerated, terracotta, cement. RED-DET effectively dissolves greasy substances, oils, trampling dirt, atmospheric dirt, smoke blackening, food residues. Our detergent deeply degreases without damaging the surfaces even if they are shiny, it is particularly suitable for matt / rough finishes.
 USE: 50 m² for 1 kg



RED-GRIP: PROTIVKLIZNI TRETMAN ZA BETONSKE PROIZVODE

Specifične formule za protivklizni tretman utrošnih i spoljnih površina betonskih elemenata, kao što su: ivice bazena i elemenata opremanja. Il proizvod rešava problem klizavosti prouzrokovane vodom, ne remeti estetski izgled tretirane površine, ne pravi površinske slojeve,direktno deluje na materijal kreirajući takvu mikroporoznost koji omogućava potrebno protivklizno prijanjanje u prisustvu vode.
 POTROŠNJA: 30 m² po 1 kg

ANTI-SLIP TREATMENT FOR CONCRETE PRODUCTS

Specific formulation for the anti-slip treatment of internal and external surfaces in concrete elements, such as: pool edges and furnishing elements. The product solves the problem of slipperiness caused by water, does not alter the aesthetic appearance of the treated surface, does not form surface films, acts directly on the material, creating a microporosity that allows the anti-slip grip necessary in the presence of water.
 USE: 30 m² for 1 kg



RED-NETSTONE: DETERDŽENT NA BAZI KISELINE ZA ČIŠĆENJE POVRŠINA PRIRODNOG KAMENA

Deterdžent KISEONI za čišćenje površina od kamena, unutrašnjih i spoljnih, neobrađenog finiša . Proizvod se preporučuje i za čišćenje prefabrikovanih panela, ne ostavlja tragove. RED-NETSTONE ne proizvodi neprijatne mirise ili opasan dim i rastvoriv je u vodi. Proizvod je na kiseonoi bazi: preporučuje se tako upotreba kod mermera i kretnjačkog kamena poliranog ili brušenog.
 RESA: 30 m² per 1 kg

ACID BASED CLEANER FOR CLEANING OF NATURAL STONE SURFACES

Acid detergent for cleaning stone surfaces with a rough finish laid internally and externally. The product is also recommended for cleaning prefabricated panels, it leaves no residue. RED-NETSTONE does not produce unpleasant odors or dangerous fumes and is dilutable in water. The product is acid-based: therefore it is not recommended to use it on polished or brushed marble and limestone.
 USE: 30 m² for 1 kg



RED-PROTECT: TRETMAN PROTIV FLEKA NA BAZI VODE ZA POROZNE POVRŠINE

Protiv fleka na vodenoj bazi pogodan za zaštitu i konsolidovanju površina materijala od kamena, terakote, betona. I pored svojih osobina totalne kompatibilnosti sa vodom savetuje se da se ne aplicira RED-PROTECT na preferano okvašenim podlogama jer, iako se ne bi poništio efekat tretmana, ne bi bio preferano dugotrajn.
 POTROŠNJA: 40 m² po 1 kg

STAIN RESISTANT TREATMENT WATER BASED FOR POROUS SURFACES

Water-based stain-resistant product suitable for the protection and consolidation of surfaces in stone, terracotta and concrete materials. Despite its characteristics of total compatibility with water, it is advisable not to apply RED-PROTECT on excessively wet substrates which, while not nullifying the effectiveness of the treatment, would make it less valid as it lasts over time.
 USE: 40 m² for 1 kg

Šifra/code	Opis/description	Cena/price
9030048	RED-DET odmašćivač 1lt /RED-DET degreaser 1lt	28,40 €
9030049	RED-GRIP protivklizni 5 kg / RED-GRIP antislip 5 kg	27,30 €
9030050	RED-NETSTONE deterdžent kiseoni 1 lt / RED-NETSTONE acid detergent 1 lt	18,20 €
9030051	RED-PROTECT protiv fleka 1 lt / RED-PROTECT stain resistant 1 lt	51,10 €



STIROPOR BLOK DUPLJE GUSTINE/ DOUBLE-DENSITY FORMWORK

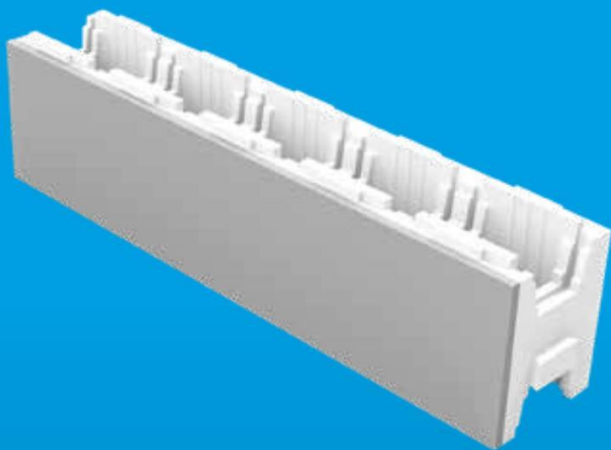

Stiropo blok duple gustine W. DENSITY.K80 je najnoviji iz našeg asortimana stiropor blokova: unutrašnjost **izuzetno velike gustine**, karakteriše velika mehanička otpornost protiv slučajnih udara na gradilištu a idealan je za realizaciju ukopanih I nadzemnih bazena.

The double-density formwork W. DENSITY. K80 is the most innovative in our range of formwork. Its very high density inner face characterizes its high mechanical resistance against accidental impacts on the construction site and is perfect for the construction of in-ground or above-ground swimming pools.



ČVRST
SOLID



ECO-ODRŽIV
ECO-SUSTAINABLE



PRILAGODLJIV
I BRZ
ADAPTABLE AND QUICK



TERMO
IZOLANT
THERMO INSULATING

pag. 33

W. DENSITY. K80

Kit of components

SET KOMPONENTI



2





Sadržaj

SET KOMPONENTI BAZENA / POOL COMPONENTS KIT

- 102 SET OPREME REAL / ACCESSORIES REAL KIT
- 102 SET REFLEKTORA SA TRANSFORMATOROM / PROJECTOR KIT WITH TRANSFORMER

FILTRACIONI SET / FILTRATION KIT

- 103 FILTRACIONI SET SA FILTEROM MEDITERRANEO / FILTRATION KIT WITH MEDITERRANEO FILTER
- 103 FILTRACIONI SET SA FILTEROM RIVALTA / FILTRATION KIT WITH RIVALTA FILTER

SET ZA KONEKCIJU / CONNECTION KIT

- 104 SET FITINGA I CEVI/ FITTINGS AND PIPES KIT
- 106 SET FITINGA I CEVI OPREME MT3 / FITTINGS AND PIPES KIT ACCESSORIES MT3
- 108 SET FITINGA I VENTILA ZA JAVNE BAZENE / FITTINGS AND VALVES KIT FOR PUBLIC POOLS
- 109 SET FITINGA I VENTILA / FITTINGS AND VALVES KIT

SET ZA ČIŠĆENJE/CLEANING KIT

- 110 SET ZA ČIŠĆENJE/CLEANING KIT
- 111 SET HEMIJSKIH PROIZVODA/CHEMICAL PRODUCTS KIT

**SET ZIDNE OPREME REAL
WALL-ACCESSORIES REAL KIT**



3 SETA PO IZBORU:

- Set br. 1: za sve bazene do 8x4 m
- Set br. 2: za sve bazene od 56 m³ do 10x5 m
- Set br. 3: za sve bazene od 91 m³ do 12x6 m
- Kit n. 1: for pools up to 8x4 m
- Kit n. 2: for pools from 56 m³ to 10x5 m
- Kit n. 3: for pools from 91 m³ to 12x6 m

Šifra/ code	Opis/description	Cena/ price
1070018	Set zidni komadi n°1 / Wall-accessories kit n°1	333,00 €
1070019	Kit zidni komadi n°2 / Wall-accessories kit n°2	556,00 €
1070020	Kit zidni komadi n°3 / Wall-accessories kit n°3	779,00 €

Sastav kompleta	Set n° 1 Količina	Set n° 2 Količina	Set n° 3 Količina
Skimer prelivni LX 7 sa umetcima od mesinga za membranu i liner / Overflow skimmer LX 7 with brass inserts for membrane and liner pools	1	2	3
Slivnik dna od ABS antivortex / Main drain in ABS with brass inserts antivortex	1	1	1
Mlaznica GM-12 bela sa prodorom od 250 mm / Return fitting GM-12 white colour with throughwall 250 mm	2	3	4
Usisna mlaznica sa čepom GM-21 bela sa prodorom / External threaded wall white vacuum point with through-wall	1	1	1

**SET REFLEKTOR SA TRANSFORMATOROM
PROJECTOR KIT WITH TRANSFORMER**



3 SETA PO IZBORU:

- Set n. 1: za 1 reflektor led beli
- Set n. 2: za 2 reflektora led beli
- Kit n. 1: for 1 light with white led
- Kit n. 2: for 2 lights with white led

Šifra/ code	Opis/description	Cena/ price
1040402	Set n. 1 / Kit n. 1	401,20 €
1040403	Set n. 2 / Kit n. 2	664,40 €

Sastav kompleta	Set n° 1 Količina	Set n° 2 Količina
Reflektor led beli serije CPA / White led projector CPA series	1	2
Razvodna kutija / Junction box	1	2
Transformator u kutiji beli sa prekidačem ON/OFF 100 VA White transformer in box with ON / OFF 100 VA	Transformatore 100 V	Transformator 100 VA

KOMPLET ZA FILTRACIJU SA FILTEROM RIVALTA



3 SETA po izboru:

Set br. 1: za sve bazene do 55 m³
 Set br. 2: za sve bazene od 56 m³ do 90 m³
 Set. Br.3: za sve bazene od 91 m³ do 120 m³
 Kit n. 1: for pools up to 55 m³
 Kit n. 2: for pools from 56 m³ to 90 m³
 Kit n. 3: for pools from 91 m³ to 120 m³

Šifra / code	Opis /description	cena / price
1080001	Set za filtraciju br. 1 10 m ³ /h monofazni Filtration set br.1-12 m ³ /h one-phase	1.518,00 €
1080002	Set za filtraciju n. 1 10 m ³ /h trofazni Filtration kit n.1-12 m ³ /h three-phase	1.591,00 €
1080003	Set za filtraciju br. 2 16 m ³ /h monofazni Filtration kit n.2-16 m ³ /h one-phase	1.775,00 €
1080004	Set za filtraciju br. 2 16 m ³ /h trifaze Filtration kit n.2-16 m ³ /h three-phase	1.803,00 €
1080005	Set za filtraciju br. 3 22 m ³ /h monofaze Filtration kit n.3-22 m ³ /h one-phase	2.226,00 €
1080006	Set za filtraciju br. 3 22 m ³ /h trifaze Filtration kit n.3-22 m ³ /h three-phase	2.249,00 €

Sastav kompleta	Set br. 1 Količina	Set br. 2 Količina	Set br 3 Količina
Filter RIVALTA od laminirane smole Rivalta filter in laminate resin	FS-500	FS-650	FS-760
Džak peska od 25 kg Sand bag 25 kg	4	9	12
Pumpa sa predfilterom mono/trofazni Pump with pre-filter one-three phase	Mod. Ambra hp 0,75-mc/h 10	Mod. Ambra hp 1,00-mc/h16	Mod. Ambra hp 1,50-mc/h 22
Komandna tabla POOL CONTROL Cabinet Pool Control	Pool control	Pool control	Pool control

**KOMPLET ZA FILTRACIJU SA FILTEROM MEDITERRANEO
 FILTRATION KIT WITH MEDITERRANEO FILTER**



2 SETA PO IZBORU:

Set br 1: za sve bazene do 50 m³
 Set br. 2: za sve bazene od 51 m³ do 80 m³
 Kit n. 1: for pools up to 50 m³
 Kit n. 2: for pools from 51 m³ to 80 m³

Šifra / code	Opis /description	cena / price
1080007	Set za filtraciju br. 1 10 m ³ /h monofazni Filtration kit n.1-10 m ³ /h one-phase	1.468,00 €
1080008	Set za filtraciju br. 1 10 m ³ /h trofazni Filtration kit n.1-10 m ³ /h three-phase	1.541,00 €
1080009	Set za filtraciju br.2 16 m ³ /h monofazni Filtration kit n.2-16 m ³ /h mono-phase	1.742,00 €
1080010	Set za filtraciju br. 2 16 m ³ /h trofazni Filtration kit n.2-16 m ³ /h three-phase	1.803,00 €

Sastav kompleta	Set br. 1 Količina	Set br. 2 Količina
Filter MEDITERRANEO namotani visoke gustine sa bočnim ventilom Mediterraneo filter, coiled high-density with side valve	SIDE-500	SIDE-650
Peščani pesak od 25 kg / Sand bag 25 kg	4	7
Pumpa sa predfilterom AMBRA Pump AMBRA with pre-filter one-phase	Mod. Ambra - hp 0,75-mc/h 12	Mod. Ambra - hp 1,00-mc/h16
Komandna tabla POOL CONTROL / Cabinet Pool Control	Pool control	Pool control

KIT COMPONENTI/
KIT OF COMPONENTS

KOMPLET FITINGA I CEVI ZA UKOPANU STANDARD OPREMU
 FITTINGS AND PIPES KIT FOR STANDARD UNDERGROUND SYSTEM



Šifra/code	Opis/description	Cena/price
3000200	SET 1 cevi ukopana oprema od 6x2 M do 8x4 M KIT 1 for system from 6x2 M a 8x4 M	244,80 €
3000201	SET 2 oprema od 9x4 M do 11x5 M KIT 2 for system from 9x4 M a 11x5 M	560,20 €
3000202	SET 3 oprema od 12x5 M do 14x6 M KIT 3 for system from 12x5 M to 14x6 M	1.000,00 €
3000206	Opcional set 1 za povezivanje sa prostorom fbrg Optional kit 1 for connection to local	38,40 €
3000207	Opcional set 2 za povezivanje sa prostorom fbrg Optional kit 2 for connection to local	66,60 €
3000208	Opcional set 3 za povezivanje sa prostoom fbrg Optional kit 3 for connection to local	76,80 €

SASTAV KOMPLETA n°1 (3000200) – DIMENZJE BAZENA OD 6X2 M DO 8X4 M
 KIT COMPOSITION N° 1 (3000200) - SWIMMING POOL DIMENSIONS FROM 6X2 M TO 8X4 M

SPISAK KOMPONENTI BAZENA U SKLOPU SETa br.1:

- 1 skimer
- 2 mlaznice
- 1 podni slivnik
- 1 skimmer
- 2 return fittings
- 1 main drain

Komponente	Količina
Adapter M sa navojem 50x63x2" Threaded adapter 50x63x2 "	1
Tegla antioksidanta za fleksibilnu cev 11 Pickling jar hose 11	1
Lepak POOL-TITE - 250g POOL-TITE glue - 250g	1
Koleno za lepljenje a 90° a 50 Elbow paste at 90 ° to 50	4
koleno MF 50 Elbow MF 50	2
Naglavak Un. Na lepljenje Ø 50 Sleeve F. paste from Ø 50	2
Rolla teflona Teflon da 12 m / Roll of Teflon 12m	1
T ekal un.za lepljenje Ø 50 T equal to glue female Ø 50	1
Cev PVC flex bela IDRO-FLEX Ø50 rolna od 25m White hose	25
cev PVC kruta Ø 50 mm 10 bar Rigid PVC pipe Ø 50 mm 10 bar	1

OPCIONAL SET 1 (3000206): FITING PRIKLJUČNI POD PRITISKOM ZA POVEZIVANJE NA MAŠINSKI PROSTOR

Komponente	Količina
Sn koleno polietilene 90° Ø50x1 1/2 Elbow M PE	2
Sn spojnica polietilene Ø50x1 1/2 Joint M PE	2

SASTAV SETA n°2 (3000201) – DIMENZIJE bazena DA 9X4 M A 11X5 M

KIT COMPOSITION N ° 2 (3000201) - SWIMMING POOL DIMENSIONS FROM 9X4 M TO 11X5 M

SPISAK KOMPONENTI BAZENA U SKLOPU SETA br.2:

- 2 skimer
- 3 mlaznice
- 1 slivnik
- 1 vakum usisna mlaznica
- 2 skimmers
- 3 return fittings
- 1 main drain
- 1 vacuum

Komponente	Quantità
Koleno za lepljenje a 90° a 50 Elbow paste at 90 ° to 50	10
Koleno MF 50 90° Elbow MF 50	4
Adapter Msa navojem 50x63x2" M threaded adapter 50x63x2 "	3
Naglavak UN. Na lepljenje Ø 50 Sleeve F paste Ø 50	2
T ekal un za lepljenje Ø 50 T equal to glue female Ø 50	3
Cev PVC tvrda Ø 50 mm 10 bar Rigid PVC pipe Ø 50 mm 10 bar	2
Tegla antioksidanta za fleksibilnu cev I1 Pickling jar hose I1	1
Rolna teflona da 12 m / Roll of Teflon 12 m	2
lepak POOL-TITE - 250g POOL-TITE glue - 250g	1
Cev PVC flex bela IDRO-FLEX Ø50 rotolo da 25ml PVC pipe white flex IDRO-FLEX Ø50 25ml roll	75

OPCIONAL Set 2 (3000207): FITING pod pritiskom za povezivanje NA MAŠINSKI prostor

Komponente	Količina
Sn koleno polietilene 90° Ø 50 x 1 1/2 Elbow M PE	3
Spojnicna Sn polietilene Ø 50 x 1 1/2 Joint M PE	4

SASTAV SETA br.3 (3000202)- DIMENZIJE BAZENA OD 12X5 M DO 14X6 M

COMPOSITION OF KIT N ° 3 (3000202) - SWIMMING POOL DIMENSIONS FROM 12X5 M TO 14X6 M

SPISAK KOMPONENTI BAZENA U SKLOPU SETA br.3:

- 3 skimer
- 4 mlaznice
- 1 podni slivnik
- 1 vakum mlaznica
- 3 skimmers
- 4 return fittings
- 1 main drain
- 1 vacuum

Komponente	Količina
Adapter M sa navojem 50x63x2" / Threaded adapter 50x63x2 "	4
Tegla antioksidanta za fleksibilnu cev I1 / Pickling jar hose I1	1
lepak POOL-TITE - 500g / POOL-TITE glue - 500g	1
Koleno na lepljenje a 90° a 50 / Elbow paste at 90 ° to 50	5
Koleno MF 50 / Elbow MF 50	10
Naglavak UN na lepljenje incollare Ø 50 / Sleeve F. paste	6
Rolna Teflona od 12 m / Roll of Teflon 12 m	3
T EKAL UN na lepljenje Ø 50 / T equal to glue female Ø 50	4
Cev PVC flex bela IDRO-FLEX Ø50 rolina od 25m / White hose	150
cev PVC tvrda Ø 50 mm 10 bar / Rigid PVC pipe Ø 50 mm 10 bar	2

OPCIONAL SET 3 (3000208): FITING POD PRITISKOM ZA POVEZIVANJE MAŠINSKOM PROSTORU

Komponente	Količina
Koleno sn polietilene 90° Ø50x1 1/2 Elbow M PE	4
Spojnicna SN polietilene Ø50x1 1/2 Joint M PE	4

SET FITINGA I CEVI SAMO ZA OPREMU MT3
FITTINGS AND PIPES KIT ONLY FOR ACCESSORIES MT3



Šifra/ code	Opis/description	cena/ price
3 000203	SET 1 oprema do 9 m3/h KIT 1 up to 9 m3 / h	279,50 €
3 000204	SET2 oprema do 16 m3/h KIT 2 up to 16 m3 / h	596,80 €
3 000205	SET 3 oprema do 20 m3/h KIT 3 up to 20 m3 / h	1.051,80 €
3 000206	Optional SET 1 za povezivanje sa prostorom u fibrglas Optional SET 1 for connection to technical housing	38,40 €
3 000207	Optional SET 2 za povezivanje sa prostorom u fibrglas Optional kit 2 for connection to technical housing	66,60 €
3 000208	Optional SET 3 za povezivanje sa prostom u fibrglas Optional kit 3 for connection to technical housing	76,80 €

SASTAV SETa br.1 (3000203) PER MT3

SPISAK KOMPONENTI BAZENA U SKLOPU SETA br.1:

- 1 skimmer
- 2 mlaznice
- 1 podni slivnik
- 1 skimmer
- 2 return fittings
- 1 main drain

Komponente	Količina
Adapter M sa navojem 50x63x2" Threaded adapter 50x63x2 "	1
Adapter M sa navojem 50x63x1 1/2" M threaded adapter 50x63x1 1/2 "	1
Tegla antioksidanta TANGIT REINIGER It.1 / Pickling jar l 1	1
Lepak POOL-TITE - 250g POOL-TITE glue - 250g	1
Koleno na lepljenje a 90° Ø 50 Elbow paste at 90 ° Ø 50	4
Un holender na lepljenje Ø 50 Sleeve F. paste from Ø 50	2
Rollna Tefflona da 12 m Roll of Tefflon 12 m	1
T ekal UN na lepljenje Ø 50 T equal to glue female Ø 50	1
Cev PVC flex bela IDRO-FLEX Ø50 rolna od 25m White hose	25
cev PVC tvrda Ø 50 mm 10 bar Rigid PVC pipe Ø 50 mm 10 bar	1
Zidni prodor dim. 50 F - 2" M / 2" F Through-wall dim. 50 F - 2 "M / 2" F	2

OPTIONAL SET 1 (3000206): FITING POD PRITISKOM ZA POVEZIVANJE NA MAŠINSKI PROSTOR

Komponente	Količina
Koleno sn polietilene 90° Ø 50 x 1" 1/2 Elbow M PE	2
Spojnica sn polietilene Ø 50 x 1" 1/2 Joint M PE	2

SASTAV SETA br. 2 (3000204)

SPISAK KOMPONENTI BAZENA U SKLOPU SETA br. 2:

- 2 skimer
- 3 mlaznice
- 1 podni slivnik
- 1 vakum mlaznica
- 2 skimmers
- 3 return fittings
- 1 main drain
- 1 vacuum

Komponente	Količina
Adapter M sa navojem 50x63x1 1/2" / Threaded adapter 50x63x1 1/2"	2
Adapter M sa navojem 50x63x2" / M threaded adapter 50x63x2"	1
Tegla antioksidant TANGIT REINIGER lt.1 / Pickling jar l 1	1
Lepak POOL-TITE - 250g / POOL-TITE glue - 250g	1
Koleno na lepljenje od 90° Ø 50 / Elbow paste at 90° Ø 50	10
Naglavak UN. Na lepljenje Ø 50 Sleeve F. paste from Ø 50	2
Zidni prodor preč. 50 F - 2" M / 2" F Through-wall dim. 50 F - 2" M / 2" F	4
Rolna Teflon od 12 m / Roll of Teflon 12 m	2
T ekual UN na lepljenje Ø 50 T equal to glue female Ø 50	3
cev PVC flex bela IDRO-FLEX Ø50 rolna od 25m White hose	75
cev PVC tvrda Ø 50 mm 10 bar Rigid PVC pipe Ø 50 mm 10 bar	2

OPTIONAL SET 2 (3000207): FITING POD PRITISKOM ZA POVEZIVANJE NA MAŠINSKI PROSTOR

Komponente	Količina
Koleno sn polietilene 90° Ø 50 x 1 1/2" Elbow M PE	3
Spojnicna sn polietilene Ø 50 x 1 1/2" Joint M PE	4

SASTAV SETA br.3 (3000205)- DIMENZije bazena od 12X5 M DO 14X6 M

COMPOSITION OF KIT N° 3 (3000205) - SWIMMING POOL DIMENSIONS FROM 12X5 M TO 14X6 M

SPISAK KOMPONENTI BAZENA U SKLOPU SETA br.3:

- 3 skimer
- 4 mlaznice
- 1 slivnik
- 1 vakum mlaznica
- 3 skimmers
- 4 return fittings
- 1 main drain
- 1 vacuum

komponente	količina
Adapter M sa navojem 50 x 63 x 1 1/2" / Threaded adapter 50 x 63 x 1 1/2"	3
Adapter M sa navojem 50 x 63 x 2" / M threaded adapter 50 x 63 x 2"	1
Tegla antioksidanta TANGIT REINIGER lt.1 / Pickling jar l 1	1
Lepak POOL-TITE - 500g / POOL-TITE glue - 500g	1
Koleno na lepljenje a 90° Ø 50 / Elbow paste at 90° Ø 50	14
Naglavak un na lepljenje Ø 50	6
Zidni prodor 50F-2" M/2" F	5
Rolna Teflona od 12 m / Roll of Teflon 12 m	2
T ekal UN na lepljenje Ø 50 / T equal to glue female Ø 50	4
Cev PVC flex bela IDRO-FLEX Ø50 rolna od 25m / White hose	150
Cev PVC tvrda Ø 50 mm 10 bar / Rigid PVC pipe Ø 50 mm 10 bar	2

OPTIONAL KIT 3 (3000208): FITING POD PRITISKOM ZA POVEZIVANJE SA MAŠINSKIM PROSTOROM

Komponente	Količina
Koleno sn polietilene 90° Ø 50 x 1 1/2" Elbow M PE	4
Spojnicna sn polietilene Ø 50 x 1 1/2" Joint M PE	4

SET FITINGA I VENTILA ZA **JAVNE BAZENE** SEOSKI TURIZAM/ HOTELI
 FITTINGS AND VALVES KIT FOR PUBLIC POOLS FARMHOUSES/HOTELS

Serie FITINGA i ventila za povezivanje mašinskog prostora javnih bazena sa dva filtera i tri pumpe.
 Series of fittings and valves for technical connection of public swimming pools with two filters and three pumps.



Šifra/ code	Opis/description	cena/ price
1035660	Set br 1 od 2 filtera 500-650, 3 pumpe 1CV Kit n° 1 with 2 filters 500-650 and 3 pumps	1.117,00 €
1035661	Set br.2 od 2 filtera 750/1000, 3 pumpe 2/3CV Kit n° 2 with 2 filters 750/1000 and 3 pumps 2/3 CV	1.856,80 €

SASTAV SETA br. N°1

Komponente	Količina	komponente	količina
koleno 90° Ø 50 / elbow 90° Ø50	12	Povratni ventil preč.63 / check valve Ø63	1
koleno 90° diam.63 / elbow 90° Ø63	10	Spoj 50x1"1/2 / union 50 X 1 1/2	6
Kuglasti ventili preč.63 / ball-valves Ø 63	2	Obujmica sa tiplom preč.50 / pipe clips Ø50	6
Kuglasti ventili preč.50 / ball-valves Ø 50	14	Lepak Tangit 500 gr. / pack of glue 500 g Tangit	2
T reduk. 75x50x75 / reducing tee 75x50x75	12	Tegla antioksidanta Tangit Reiniger / pickling	1
T reduk. 75x63x75 / reducing tee 75x63x75	2	m Cev PVC tvrda preč.75 / m of rigid PVC pipe Ø75	12
T reduk. 90x63x90 / reducing tee 90x63x90	2	m cev PVC tvrda preč.63 / m of rigid PVC pipe Ø63	6
Povratni ventil preč.50 / check valve Ø50	3	m Cev PVC tvrda preč.50 / m of rigid pipe Ø50	18

SASTAV SETA br.2

Komponente	Količina	komponente	količina
Kuglasti ventili preč.63 / ball-valves Ø 63	12	Koleno 90° preč.50 / elbow 90° Ø50	6
Kuglasti ventili preč.50 / ball-valves Ø 50	8	Spoj 63x2" / union 63 X2"	4
Povratni ventil preč.63 / check valve Ø 63	3	Spoj 3 kom preč.63 / union 3 pieces Ø63	2
m cev PVC tvrda preč.90 / m of rigid PVC pipe Ø90	18	Rukav čaura preč.63 / adapter socket Ø63	2
m Cev PVC tvrda preč.63 / m of rigid PVC pipe Ø63	18	Rukav čaura preč..90 / adapter socket Ø90	1
m cev PVC tvrda preč.50 / m of rigid PVC pipe Ø50	6	Reduktor 90x63 / reduction 90x63	2
T reduk. 90x63x90 / reducing tee 90x63x90	12	Obujmica sa tiplom preč.90 / pipe clips Ø90	6
T reduk. 90x50x90 / reducing tee 90x50x90	8	Lepak Tangit 500 gr. / pack of glue 500 g Tangit	2
Koleno 90° preč.90 / elbow 90° Ø90	9	Tegla deoksidanta Tangit Reiniger / pickling	1
koleno 90° preč.63 / elbow 90° Ø63	10	Roleta profesionalne trake / professional roll of tape	6

SET FITINGA I VENTILA MAŠINSKI PROSTOR PUMPE I FILTER
FITTINGS KIT AND TECHNICAL ROOM VALVES FOR PUMPS AND FILTER



Šifra/ code	Opis/description	Cena/ price
3 000209	SET 1 filter 500 i pumpa 10 m3/h / kit 1, filter 500 and pump 10 m3/h	254,50 €
3 000210	SET 2 filter 650 i pumpa 16 m3/h / kit 2, filter 650 and pump 16 m3/h	402,20 €
3 000211	SET 3 filter 750 i pumpa 22 m3/h / kit 3, filter 750 and pump 22 m3/h	525,90 €
3 000212	SET 4 filter 900 i pumpa 30 m3/h / kit 4, filter 900 and pump 30 m3/h	588,40 €

SASTAV SET br.1

Komponente	količina	komponente	Kvalitet
Kuglasti ventili Ø 50 / Ball valves Ø 50	3	Obujmica sa tiplom Ø 50 / Collars with plug Ø 50	4
Te 90° Ø 50 / Te 90° Ø 50	1	Tvrda cev PN 10 Ø 50 / Rigid pipe PN 10 Ø 50	6 m
Spojevi 1 1/2" x 50 / Inlet 1 1/2" X 50	3	Muf čaura na lepljenje Ø 50 / Sleeves paste Ø 50	3
Reduktori Ø 63 - 50 / Reductions Ø 63 - 50	2	Pakovanje lepka od 250 gr. Tangit / Packed with the 250	1
Kolena 90° Ø 50 / 90° elbow Ø 50	8	Konf. deoksidanta 1 l. / Pickling Pack 1 l.	1
Koleno 45° Ø 50 / Elbow 45° Ø 50	1	Roine teflon profesionalne / Rolls Teflon professional	2

SASTAV SETA br.2

Komponente	količina	Komponente	količina
Kuglasti ventili Ø 50 / Ball valves Ø 50	7	Obujmice sa tiplom Ø 50 / Collars with plug Ø 50	8
Te 90° Ø 50 / Te 90° Ø 50	7	Tvrda cev PN 10 Ø 50 / Rigid pipe PN 10 Ø 50	9 m
Spojevi 1 1/2" x 50 / Inlet 1 1/2" X 50	3	Muf čaura na lepljenje Ø 50 / Sleeves paste Ø 50	7
Reduktori Ø 63 - 50 / Reductions Ø 63 - 50	2	Konf. lepka od 250 gr. Tangit / Packed with the 250 gr	1
Kolena 90° Ø 50 / 90° elbow Ø 50	16	Konf. antioksidanta 1 l. / Pickling Pack 1 l.	1
Koleno 45° Ø 50 / Elbow 45° Ø 50	2	Roine teflon profesionalne / Rolls Teflon professional	2

SASTAV SETA br.3

Komponente	količina	Komponente	količina
Kuglasti ventili Ø 50 / Ball valves Ø 50	9	Rukav čaura za lepljenje Ø 50 / Sleeves paste Ø 50	9
T reduk. 63 x 50 x 63 / T reduced 63 x 50 x 63	9	Kape Ø 63 / Caps Ø 63	2
Spojevi 2" x 63 / Inlet 2" X 63	3	Tvrda cev PN10 Ø 50 / Rigid pipe PN10 Ø 50	6 m
Kolena 90° Ø 63 / 90° elbow Ø 63	8	Tvrda cev PN10 Ø 63 / Rigid pipe PN10 Ø 63	3 m
Kolena 45° Ø 63 / 45° elbow Ø 63	2	Konf. lepka od 500 gr. Tangit / Packed with 500 gr. Tangit.	1
Koleno 90° Ø 50 / Elbow 90° Ø 50	12	Konf. antioksidant 1 l. / Pickling Pack 1 l.	1
Obujmice sa tiplom Ø 50 / Collars with plug Ø 50	10	Roine teflon profesionalne / Rolls Teflon professional	2

SATAV SETA br.4

Komponente	količina	komponente	količina
Kuglasti ventili Ø 50 / Ball valves Ø 50	8	Obujmice sa tiplom Ø 63 / Collars with plug Ø 63	2
Kuglasti ventili Ø 63 / Ball valves Ø 63	1	Muf čaura na lepljenje Ø 50 / Sleeves paste Ø 50	8
T reduk. 63 x 50 x 63 / T reduced 63 x 50 x 63	8	Muf čaura na lepljenje Ø 63 / Sleeves paste Ø 63	1
TE Ø 63 / TE Ø 63	1	Kape Ø 63 / Caps Ø 63	1
Spojevi 2" x 63 / Inlet 2" X 63	3	Tvrda cev PN10 Ø 50 / Rigid pipe PN10 Ø 50	6
Kolena 90° Ø 63 / 90° elbow Ø 63	10	Tvrda cev PN10 Ø 63 / Rigid pipe PN10 Ø 63	6
Kolena 45° Ø 63 / 45° elbow Ø 63	2	Konf. lepka od 250 gr. Tangit / Packed with 250 gr. Tangit.	1
Koleno 90° Ø 50 / Elbow 90° Ø 50	18	Tegla antioksidanta 1 l. / Pickling Pack 1 l.	1
Koleno 45° Ø 50 / Elbow 45° Ø 50	2	Roine teflona profesionalne / Rolls Teflon professional	2
Obujmice sa tiplom Ø 50 / Collars with plug Ø 50	9		

SET ZA ČIŠĆENJE/CLEANING KIT



ŠIFRA 105501
kit 1 standard

cod. 1055086
kit 3 mini



cod. 1056000
kit 4 - 7 pezzi

Šifra/ code	Opis/description	cena/ price
1055001	Set 1 Standard	188,30 €
1055002	Set 2 Luxe	235,50 €
1055086	Set 3 Mini	32,00 €
1056000	Set 4 - 7 kom	54,80 €

SET 1 STANDARD U SASTAVU:

- 1 površinska mrežica od PVC
- 1 zidna četka 45 cm in PVC
- 1 usisivač poda sa balastom trouglasti
- 1 plutajuća cev 12 m Ø 38
- 1 teleskopska ručka da 2,40 a 4,80 m
- 1 beli plutajući termometar
- 1 tester set hlora i tečnog pH
- 1 PVC net for surface
- 1 brush for wall 45 cm in PVC
- 1 triangular ballasted draws-bottom
- 1 float pipe 12 m Ø 38
- 1 telescopic handle from 2.40 to 4.80 m
- 1 white floating thermometer
- 1 test kit chlorine and liquid pH

KIT 2 LUXE U SASTAVU:

- 1 površinska mrežica Luxe quadro Al
- 1 mrežica dna Luxe quadro Al
- 1 zidna četka 45 cm sa ojačanjem Al
- 1 četka površine vode
- 1 usisivač poda lux providni trouglasti
- 1 plutajuća cev 12 m Ø 38
- 1 teleskopska ručka da 2,40 a 4,80 m
- 1 beli plutajući termometar
- 1 testera hlora i pH tečnoga
- 1 PVC screen for surface Luxe, Al panel
- 1 net for bottom Luxe, Al panel
- 1 brush for wall 45 cm, Al reinforced
- 1 brush for water-line
- 1 transparent triangular draws-bottom Luxe
- 1 float pipe 12 m Ø 38
- 1 telescopic handle from 2.40 to 4.80 m
- 1 white floating thermometer
- 1 test kit chlorine and liquid pH

SET 3 MINI U SASTAVU:

- 1 usisivač dna liner trouglasti
- 1 zidna četka 26 cm
- 1 površinska mrežica
- 1 termometar jumbo
- 1 triangular draws-bottom
- 1 brush for wall 26 cm
- 1 net for surface
- 1 jumbo thermometer

SET 4 - 7 KOMADA U SASTAVU:

- 1 površinska mrežica od PVC
- 1 mrežica poda od PVC
- 1 zidna četka 45 cm od PVC
- 1 četka za površinu vode
- 1 usisivač poda sa balastom trouglasti
- 1 beli plutajući termometar
- 1 tester hlora i pH tečnog
- 1 PVC net for surface
- 1 PVC net for bottom
- 1 brush for wall 45 cm in PVC
- 1 brush for water-line
- 1 triangular ballasted draws-bottom
- 1 white floating thermometer
- 1 test kit chlorine and liquid pH

SET HEMIJSKIH PROIZVODA/CHEMICAL PRODUCTS KIT



1 kanta od
5 kg Magiclor



1 kanta od 5 kg Clorolong
da 200 g



1 kanta
od 5 kg Redminus



1 kanister
od 5 litara K-3 SUPER



1 konfekcija od 1 kg
deterdženta nivoa vode
LINEAGEL



1 kutija ketridža K-KLARA

KIT COMPONENTI/
KIT OF COMPONENTS

Komplet hemijskih proizvoda sadrži: 1 kantu od 5 kg Magiclor; 1 kantu od 5 kg Clorolong od 200 g; 1 kantu od 5 kg Redminus; 1 kanister od 5 litara K-3 SUPER; 1 kutija ketridža K-KLARA; 1 konfekcija od 1 kg deterdženta površine vode LINEAGEL.

The kit chemical products includes: 1 pail of 5 kg Magiclor, 1 pail of 5 kg Clorolong 200 g, 1 pail of 5 kg Redminus; 1 x 5 liters of Super K-3, 1 box of cartridges K-KLARA, 1 pack of 1 kg detergent from the LINEAGEL water line.

Šifra/ code	Opis/description	Cena/ price
9010000	Set proizvoda za tretman Kit for treatment	157,00 €

Equipment
OPREMA



3



SADRŽAJ

HIDRAULIČNO POSTROJENJE / HYDRAULIC CIRCUIT

ZIDNA OPREMA U ABS / ABS WALL ACCESSORIES

- 120 ZIDNA OPREMA REAL/ REAL WALL ACCESSORIES
- 132 ZIDNA OPREMA STANDARD / STANDARD WALL ACCESSORIES
- 138 REFLEKTORI SERIE STANDARD / UNDERWATER LIGHT STANDARD SERIES
- 139 REFLEKTORI SERIE MT-4 / UNDERWATER LIGHT MT-4 SERIES
- 145 ZIDNA OPREMA SERIE MT-3 / MT-3 SERIE ACCESSORIES
- 151 ZIDNA OPREMA SERIE MT-14 / MT-14 SERIE ACCESSORIES
- 153 OPREMA SERIE W / W SERIES ACCESSORIES
- 155 ZIDNA OPREMA INOX / INOX SERIES ACCESSORIES

FILTRI / FILTERS

- 161 RIVALTA
- 162 MEDITERRANEO
- 164 PANAMA
- 165 TIRRENO
- 166 COLORADO
- 167 FILTER MONOBLOCCO / SAND FILTER SYSTEM
- 169 FILTERI SA ULOŠKOM / CARTRIDGE FILTERS
- 170 FILTRIRAJUĆA PUNJENJA

PUMPE SA PREFILTEROM / PUMPS WITH PREFILTER

- 172 SERIE AMBRA/ AMBRA SERIES
- 174 SERIE SERENA/ SERENA SERIES 176
SERIE BRETON / BRETON SERIE
- 177 SERIE CARRERA / CARRERA SERIES
- 178 SERIE SPECK BADU ENERGY
- 179 BADU ECO TOUCH PRO PROMENLJIVE BRZINE/ BADU ECO VARIABLE SPEED PUMP
- 180 POMPA BADU ECO FLEX PROMENLJIVE BRZINE / BADU ECO FLEX VARIABLE SPEED PUMP
- 181 SERIE E.SWIM PROMENLJIVE BRZINE DAB / E.SWIM SERIES VARIABLE SPEED DAB
- 182 SERIE VIENNA / VIENNA SERIES

PUMPE BEZ PREFILTERA / PUMPS WITHOUT PREFILTER

- 183 SERIE ARCA 750-1500A / ARCA SERIES 750-1500A
- 184 SERIE ADRIA / SERIES ADRIA
- 185 HIDROMASAŽNE PUMPE ZA SPA / HYDROMASSAGE SPA SERIES
- 185 SERIE ARCA PROTIVSTRUJNO PLIVANJE / ARCA SERIES COUNTER CURRENT SYSTEM

PROTIV STRUJNO PLIVANJE / COUNTER CURRENT SYSTEM

- 186 ANGEL, RIVER E GULFSTREAM

HIDROMASAŽA / HYDROMASSAGE

- 187 BADUJET WAVE, BADUJET SMART, NIAGARA, BELLOW JET
- 191 KOMPRESORI I HIDROMASAŽNE MLAZNICE / HYDROMASSAGE BLOWER AND RETURN FITTINGS
- 197 HIDROMASAŽNA OPREMA / HYDROMASSAGE ACCESSORIES

199 SET HIDROMASAŽNIH KOMPLETA / HYDROMASSAGE COMPLETE KIT

202 FITINZI I CEVI

ELEKTRONSKE TABLE

- 218 MERLINO
- 225 POOL CONTROL
- 226 KOMANDNA TABLA SA PNEUMATSKIM TRANSDUKTOROM / POOL CONTROL WITH PNEUMATIC TRANSDUCER
- 227 TABLA SA PIEZOELEKTRIČNIM PREKIDAČEM / POOL CONTROL WITH PIEZOELECTRIC BUTTON
- 229 TRANSFORMATORI / TRANSFORMERS

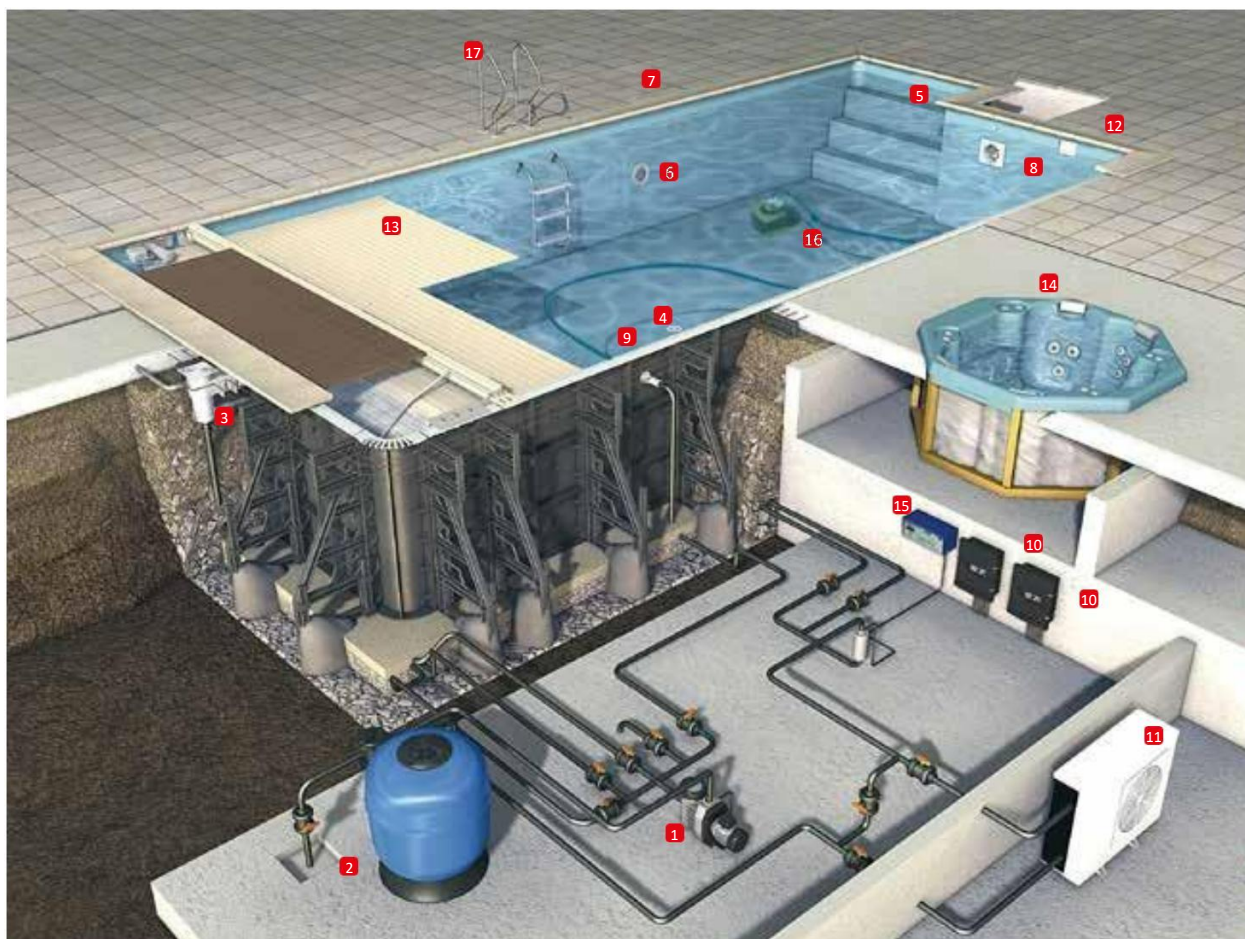

1. Filtraciona pumpa sa predfilterom

1 Pump with prefilter

2. Filter sa šestopoložajnim ventilom

2 Filter with 6-way valves

3. SKIMER sa korpicom za nečistoću i krilcem

3 Skimmer, suction flow rate

4. Podni slivnik sa rešetkom

4 Dual function main drain

3. Dovodne mlaznice sa podesivim difuzorom

5 Return fitting with a directional jet

4. Reflektor, bele boje ili RGB menjač boje

6 Underwater light, color white or RGB

5. Razvodna kutija

7. Deck box

8. Protivstrujno plivanje

8 Counter current system

9. Usisna zidna vakum mlaznica

9. Vacuum point

10. Električna tabla sa satom, tabla sa transformatorom za reflektor

10. Control Panel with time

11. Opcija toplotne pumpe

11. Heat pump option

12. Opcija regulator nivoa

12 Level controller option

13. Automatska potopljena prekrivka

13. Submerged automatic cover

14. SPA

14 Spa

15. Elektroliza soli, generator hlora

15. Chlorine generator

16. Automatski čistač

16. Automatic cleaner

17. Stepenište za pristup

17. Ladder

POZICIONIRANJE ZIDNOG FITINGA
PLACEMENT OF THE POOL FITTINGS

SKIMMER
 SKIMMER

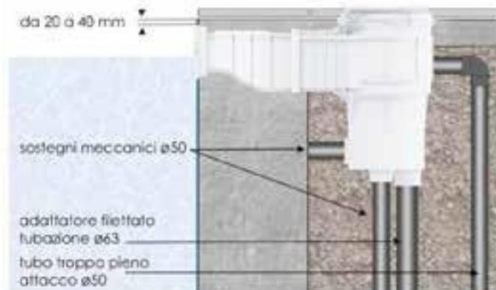

MLAZNICA SA ZIDNIM PRODOROM C-27
 RETURN FITTING C-27



VAKUM TAČKASAPRODOROM
 VACUUM POINT WITH THROUGHWALL

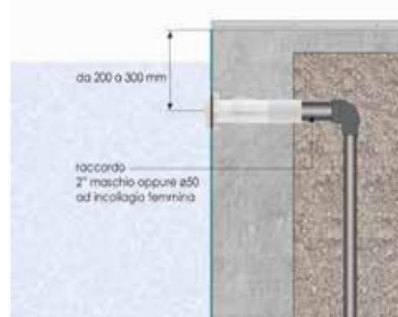

USISNA MLAZNICA ZA HIDROMASAŽU
 SUCTION FOR HYDRO

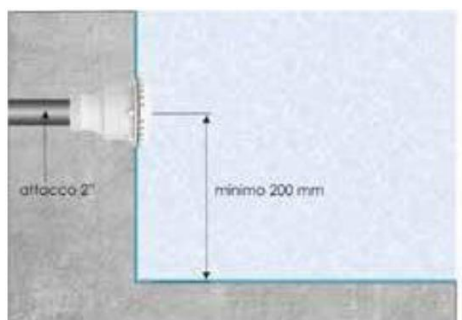

GLAVNI SLIVNIK
 MAIN DRAIN

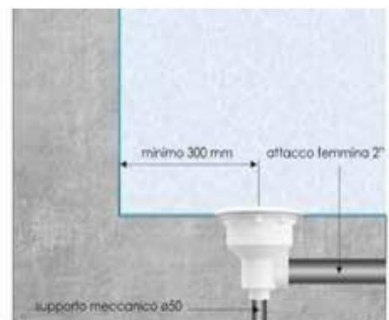

REGULATOR NIVOVA
 LEVEL CONTROLLER

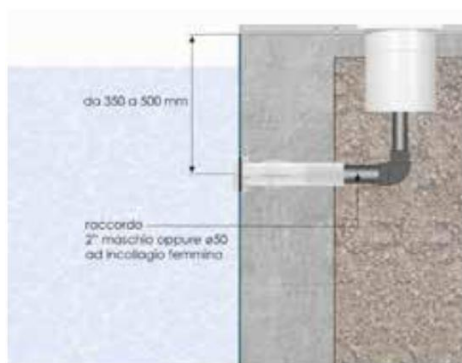

REFLEKTOR
 UNDERWATER LIGHT

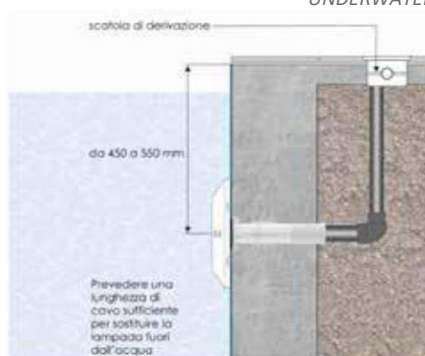

UNI-EN 13451/16582-1/16713-2



REAL

BOJENI

REAL



PRELIVNI SKIMER LX7
SKIMMER OVERFLOW LX7



POTISNE MLAZNICE GM-12



USISNA MLAZNICA GM-21
VACUUM POINT 21



Potisne MLAZNICE GM-15 SA UMETKOM
RETURN FITTING GM-15 WITH INSERT



Potisne MLAZNICE GM-18 BEZ UMETKA
RETURN FITTING GM-18 WITHOUT INSERT



USISNA MLAZNICA GM-27 SA UMETKOM
VACUUM POINT GM-27 WITH INSERT



Usisna MLAZNICA GM-24 S BEZ UMETKA
VACUUM POINT GM-24 WITHOUT INSERT



SLIVNICI ANTIVORTEX
ANTIVORTEX MAIN DRAIN



SLIVNICI SA RAVNIM IZVODOM GM-30
MAIN DRAIN GM-30 FLAT GRIP



USISAVANJE ZA HIDROMASAŽNU INSTALACIJU
GM-9
SUCTION FOR HYDRO INSTALLATIONS GM-9



PRELIVNI SKIMER LX7 OBOJENI
SKIMMER OVERFLOW LX7 COLORED



MLAZNICE GM-12 OBOJENE
RETURN FITTING GM-12 COLORED



ZIDNA USISNA MLAZNICA GM-21 OBOJENA
VACUUM POINT GM-21 COLORED



GLAVNI SLIVNIK ZA BOJENE LAJNERE
MAIN DRAIN FOR LINER COLORED



GLAVNI SLIVNICI SA RAVNIM IZVODOM
GM-30 BOJENI
MAIN DRAIN GM-30 FLAT GRIP COLORED



USISAVANJE ZA HIDROMASAŽNU INSTALACIJU
GM-9 BOJENA SUCTION COLORED FOR HYDRO
INSTALLATIONS

SAVRŠENA HARMONIJA



SKIMER
COLORED SKIMMER



POKLOPAC RAMA SA KRILCEM
COVER FRAME COMPLETE WITH FLAP

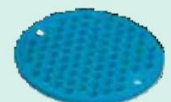

Prirubnica, REŠETKA I zaptivke
MLAZNICA C-319
FLANGES, GRATINGS AND GASKETS
JET C-319



FIKSNI REFLEKTORI
FIXED UNDERWATER LIGHT

STANDARD



SKIMER ABS ZA LAJNER
ABS SKIMMER FOR LINER



SKIMER PRELIVNI ZA PANEL BAZENE
SKIMMER OVERFLOW FOR PANELS



REGULATOR NIVOA
MECHANICAL FLOAT LEVEL CONTROLLER



POTISNE I USISNE MLAZNICE
RETURN FITTING IN ABS FOR LINER



UNIVERZALNI ZIDNI PRODOR



USISNA MLAZNICA SA REŠETKOM



DELOVI MLAZNICA
RETURN FITTING ACCESSORIES



FISKNI REFLEKTORI
FIXED UNDERWATER LIGHT



RAZVODNE UNIVERZALNE KUTIJE
UNIVERSAL DECK BOXES

MT-4



MINI REFLEKTOR
MINI UNDERWATER LIGHT



RAVNI REFLEKTOR
FLAT UNDERWATER LIGHT



MIKRO REFLEKTORI
MICRO PROJECTORS



LED SIJALICA ZA UNIVERZALNI REFLEKTOR
LED LAMP FOR UNDERWATER LIGHT



KOMADNA RADIO KUTIJA
RADIO CONTROL BOX



LED REFLEKTOR INOX
STAINLESS STEEL LED LIGHT



REFLEKTOR NA PUNJENJE,
NEPROMOČIV I POKRETLJIV
LAMP RECHARGEABLE,
WATERPROOF AND MOBILE



LED REFLEKTOR EXTRA RAVAN
EXTRA FLAT LED UNDERWATER LIGHT

MT-3



DONJA MLAZNICA
BOTTOM INLET



USISNA MLAZNICA
VACUUM POINT



POTISNE MLAZNICE
RETURN FITTINGS



DONJI SLIVNICI
MAIN DRAIN



SKIMER ZA LAJNERE
I ZA BETONSKE BAZENE
BAZENESKIMMER FOR LINER
AND FOR CONCRETE POOLS



ZIDNI PRODOR
THROUGH WALL FLANGE



REFLEKTORI
UNDERWATER LIGHT



MINI REFLEKTORI ZA BETONSKE
BAZENE I LAJNER
MINI UNDERWATER LIGHTS
FOR CONCRETE AND LINER POOL



MINI REFLEKTORI ZA BAZENE OD
PANELA I FIBERGLASA
MINI UNDERWATER LIGHTS
FOR PANEL AND FIBERGLASS POOL



RAZVODNA KUTIJA
DECK BOX



SAVITLJIVE CEVI
FOR UNDERWATER LIGHT

MT-14



SKIMMER SERIE IN ABS
PER LINER
SKIMMER IN ABS
FOR LINER



REGULATOR NIVOVA,
MLAZNICA NIVOVA
LEVEL REGULATOR
LEVEL NOZZLE



VAKUM UTIČNICA
VACUUM POINT



ULAZNE MLAZNICE
RETURN FITTING



DONJE MLAZNICE
BOTTOM INLET



PODNI SLIVNICI
MAIN DRAIN



REFLEKTOR SERIE
UNDERWATER LIGHT

WELTICO



SKIMER FILTER



TWINFILTRE

MLAZNICE
NOZZLESLED RAVNI REFLEKTORI
FLAT UNDERWATER LED LIGHTSREFLEKTOR EASYLED
UNDERWATER LED LIGHT EASYLEDUNIVERZALNE SIJALICE
SA BRZOM MONTAŽOM
UNIVERSAL LAMPS EASY TO
INSTALL

INOX

DONJI SLIVNICI
MAIN DRAINČELIČNE INOX MLAZNICE AISI
316
STAINLESS STEEL AISI 316
RETURN FITTINGVAKUM USISNI
NASTAVAK ZA BLATOPOTISNA PODNA MLAZNICA
FLOOR RETURN FITTING

SKIMER INOX

PRIGUŠIVAČ PRELIVA
OVERFLOW SILENCER

INOX REFLEKTORI

MINI REFLEKTOR LED LORY POOL ZA
BAZEN, FIKSNA BOJA E RGB MINI LED
LIGHT LORY POOL,
FIXED COLOR AND RGBMINI REFLEKTOR A LED LUKE
ZA BAZEN, FIKSNA BOJA E RGB MINI
LED LIGHT LUKE POOL,
FIXED COLOR AND RGBREFLEKTORI INOX 316
UNDERWATER LIGHTS INOX 316SIJALICA LED GRETA FIKSNA BOJA
GRETA BULB FIXED COLORREFLEKTOR LED LUCYFLOOR ZA
POD
LED FLOODLIGHT LUCYFLOOR FLOORREFLEKTOR LED CRIS ZA
TURSKO KUPATILO
LED LIGHT TURKISH BATHTRANSFORMATORI -
TRASFORMATORIRAZVODNA KUTIJA
DRIVER DDL FOR RGB

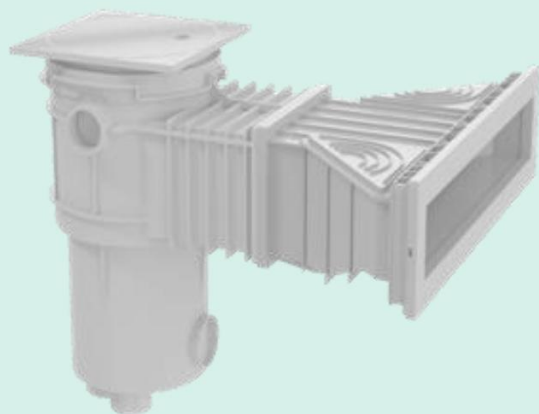

PRELIVNI SKIMER za bazene sa oblogom membrana/liner ili beton sa umetcima od mesinga, navojni priključak 2". Na raspolaganju sendvič dihtunzi za bazene u čeličnim panelima. *Overflow Skimmer for swimming pools with membrane / liner or concrete lining with brass inserts 2" threaded connection. Sandwich gasket for pools in steel panels is available.*

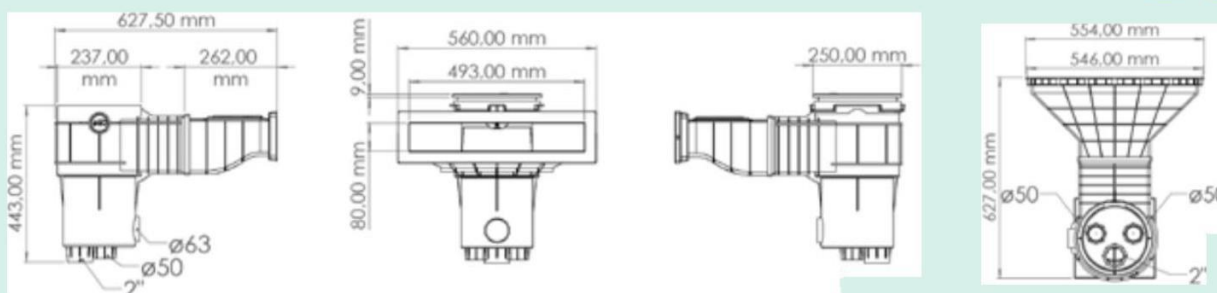

Šifra /code	Opis /description	Cena/price
2220180	Prelivni Skimer LX7 sa mesinganim umetcima za membranailiner Overflowskimmer LX7 with brass inserts for membrane and liner pools	193,40 €
1070811	Sendvič zaptivke za skimer LX7 e LX7 Real Sandwichseal for LX7 and LX7 Real skimmer	22,10 €



Šifra /code	2220181	2220182	2220183	2220184	2220185	Cena/price
Boja/color	sivo grey	antracite greyanthracite	svetlo plava lightblue	plava blue	pesak sand	204,00 €



POTISNE MLAZNICE GM-12 / RETURN FITTINGS GM-12



NEW

Mlaznice sa prolazom od 25 cm i sa podesivim mlazom protiv zaglavljivanja, za betonske obložene liner bazene, sa lepljenim spojem Ø50 mm ili 2" muškim navojnim spojem opremljena navojnim mesinganim umetcima.

Return fitting with 25 cm pass-through and adjustable anti-entrapment jet, for concrete / liner pool, with Ø50 mm glue-in connection or 2" male thread.

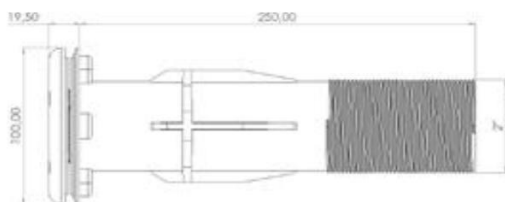

OPREMA

Šifra /code	Opis /description	Cena/price
1072323	Mlaznica GM-12 bela sa prolazom od 250 mm za liner i podesivim mlazom ReturnfittingGM-12whitecolourwiththrogwall250mmforliner,withadjustablejet	29,50 €



Šifra /code	1072324	1072325	1072326	1072327	1072328	Cena/price
Boja/color	svetlo plava blue	plava blue	siva grey	pesak sand	antracite greyanthracite	32,80 €

USISNE MLAZNICE GM-21 / VACUUM POINT GM-21

REAL



NEW



Sa zidno prolaznim priključkom od 250 mm, sa spojem za lepljenje Ø50 mm ili muškim navojnim spojem 2", za bazene obložene liner ili betonske, sa navojnim mesinganim umetcima.

Vacuum point with 250 mm wall pass-through, with Ø50 mm glue connection or 2" male thread, for swimming pools with membrane / liner or concrete, with **threaded brass inserts**.

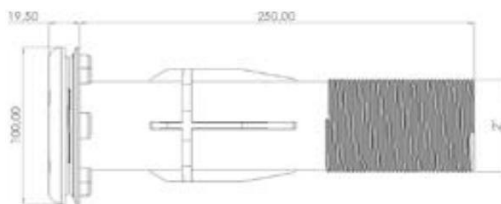

Šifra /code	Opis /description	Cena/price
1034005	Usisna mlaznica sa čepom GM-21 belazidna navoj 2" spoljni - preč. 50 unutrašnji sa prodorom za betonske bazene/liner mlaznica preč. 20 mm external threaded wall white vacuum point GM-21: - internal diam. 50 with pass-through for concrete pools / liner nozzle diam. 20 mm	28,00 €



Šifra /code	1034006	1034007	1034008	1034009	1034010	Cena/price
Boja/color	sv. plav light blue	plava blue	siva grey	pesak sand	antracite grey anthracite	31,30 €



POTISNE MLAZNICE GM-15 / RETURN FITTINGS GM-



Mlaznica, sa poklopcem podesivim protiv zaglavlivanja, pogodna za sve vrste struktura, i za tanke zidove, sa navrtkom za brzo fiksiranje. Za bazene sa oblogama membrane/lajner, od fiberglasa ili betona. Opremljena sa umetcima sa mesinganim navojem za lako i brzo održavanje u vremenu. Lepljeni spoj Ø50 mm ili 2" muški navoj.

Return fitting with adjustable anti-trapping ball, suitable for all types of structures, even thin walls, with quick fixing nut. For swimming pools with membrane / liner, fiberglass and concrete lining. Equipped with brass threaded inserts for easy and quick maintenance over time. Glue-in connection Ø50 mm or 2" male thread.



Šifra /code	Opis /description	Cena/price
-------------	-------------------	------------

1070354	Mlaznica GM-15 bela sa umetcima za lajner sa podesivim mlazom za beton WhiteGM-15returnfittingwithinsertsforlinerwithadjustablejetforconcretewall	19,60 €
---------	--	---------



Šifra /code	1070358	1070359	1070360	1070361	1070362	Cena/price
-------------	---------	---------	---------	---------	---------	------------

Boja/color	sv.plav	plava blue	siva grey	pesak sand	antracite greyanthracite	21,60 €
------------	---------	---------------	--------------	---------------	-----------------------------	---------

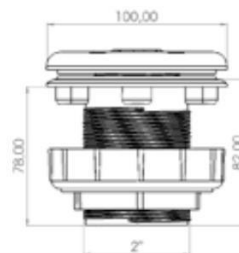

šifra/code	Opis /description	Cena/price
------------	-------------------	------------

1070317	MlaznicaGM-15 bela sa umetcima za lajner sa podesivim mlazom za betoni tanki zid WhiteGM-15returnfittingwithinsertsforlinerwithadjustablejetforconcreteandthinwall	24,40 €
---------	---	---------



Šifra /code	1070318	1070319	1070320	1070321	1070322	Cena/price
-------------	---------	---------	---------	---------	---------	------------

Boja/color	svetlo plava	plavo blue	sivo grey	pesak sand	antracite grey anthracite	26,40 €
------------	-----------------	---------------	--------------	---------------	------------------------------	---------

MLAZNICE GM-18 / RETURN FITTINGS GM-18

REAL



NEW

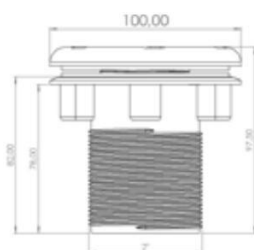

Mlaznica sa krugom podesivim protiv zagljavlivanja, pogodna za sve vrste struktura, takođe za tanke zidove, sa maticom za brzo zatezanje. Za bazene sa oblogama membrana/ liner, fibreglasom i betonom. Spoj na lepljenje Ø50 mm ili muškinavoj od 2". Dupla serija rupa za fiksiranje.

Return fitting with adjustable anti-trapping ball, suitable for all types of structures, even thin walls, with quick fixing nut. For swimming pools with membrane / liner, fiberglass and concrete lining. Glue-in connection Ø50 mm or 2 "male thread. Double series of fixingholes.



šifra /code	Opis/description	Cena/price
1070355	Mlaznica GM-18 bela za liner sa podesivim mlazom za beton WhiteGM-18returnfittingwithinserts forlinerwithadjustablejetforconcretewall	18,00 €



Šifra/code	1070365	1070366	1070367	Cena/price
Boja/color	sivo grey	Pesak sand	antracite sivo anthracite	20,20 €

ZIDNI PRODOR SERIE MT-3 / THROUGH WALL FLANGE MT-3

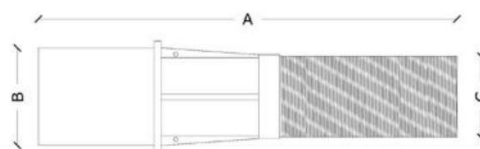

DIMENZIJE / DIMENSIONS

A mm	B mm	C mm
300	63(2")	50

Šifra/code	Opis/description	Cena/price
2220107	Zidni prodor diam. 50 F-2"M / 2"F / through wallflange Ø 50F-2"M / 2"F	9,20 €

USISNA MLAZNICA SA NAVOJEM GM-27 / VACUUM



USISNA mlaznica usisna za blato, pogodna za sve strukture, za tanke zidove, sa maticom za brzo fiksiranje. Za bazene sa oblogama membrana/liner, fiberglas i beton. Spoj lepljenjem Ø50 mm ili muški navoj da 2". Opremljena sa umetcima sa mesinganim navojem.

Vacuum point sucks sludge, suitable for all types of structures, even thin walls, with quick fixing nut. For swimming pools with membrane /liner, fiberglass and concrete lining. Glue-in connection Ø50 mm or 2 "male thread. **Equipped with threaded brass inserts.**



Šifra /code	Opis /description	Cena/price
1070356	Usisna mlaznica GM-27 bela sa umetkom za liner sa podesivim mlazom za beton Vacuumpoint GM-27 with white inserts for liner with swiveling jet for concretewall	18,90 €



Šifra /code	1070368	1070369	1070370	1070371	1070372	Cena/price
Boja/color	sv.plav lightblue	plava blue	siva grey	pesak sand	antracite greyanthracite	22,90 €

Šifra /code	Opis /description	Cena/price
1070329	Usisna mlaznica GM-27 sa umetcimabela za liner sa podesivim mlazom za beton I tanki zid. Vacuum point GM-27 with white inserts for liner with swiveling jet for concrete and thin wall	22,80 €

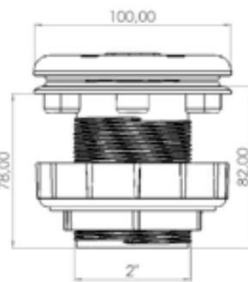

Usisna mlaznica GM-27 sa umetcimabela za liner sa podesivim mlazom za beton I tanki zid. Vacuum point GM-27 with white inserts for liner with swiveling jet for concrete and thin wall

Šifra /code	1070330	1070331	1070332	1070333	1070334	Cena/price
Boja/color	sv.Plav light blue	Plavo blue	sivo grey	pesak sand	antracite sivo anthracite	24,80 €



IMPIANTO/EQUIPMENT



USISNA MLAZNICA GM-24 / VACUUM POINT GM-24

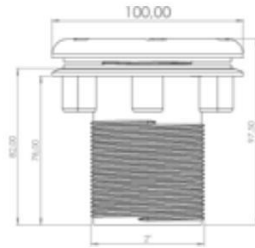

Usisna mlaznica za usisavanje blata, podesiva za svaku strukturu, takođe tanke zidove, sa maticom za brzo zatezanje. Za bazene sa oblaganjem u membrana/liner, fibreglasom i betonom. Spoj na lepljenje Ø50 mm o muški navoj od 2". **Dupla serija rupa za fiksiranje.**

Vacuum point sucks sludge, suitable for all types of structures, even thin walls, with quick fixing nut. For swimming pools with membrane / liner, fiberglass and concrete lining. Glue-in connection Ø50 mm or 2" male thread. **Double series of fixing holes.**



Šifra /code	Opis /description	Cena/price
1070357	Usisna mlaznica GM-24 bela bez umetaka za lajner sa podesivim mlazom za beton VacuumpointGM-27whitewithoutinserts forlinerwithswivelingjetforconcretewall	16,80 €



Šifra /code	1070374	1070375	1070376	1070377	1070378	Cena/price
Boja/color	sv.plav lightblue	plavo blue	sivo grey	pesak sand	antracite greyanthracite	18,80 €

Šifra/code	Opis/description	Cena/price
------------	------------------	------------

1070335

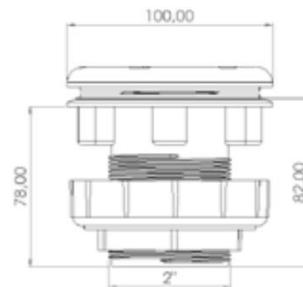

20,40 €

Usisna mlaznica GM-24 senza inserti bianca per liner con getto orientabile per cls e parete sottile
Vacuum point GM-24 without white inserts for liner with swiveling jet for concrete and thin wall



Šifra /code	1070336	1070337	1070338	1070339	1070340	Cena/price
Boja/color	celeste lightblue	azzurro blue	sivo grey	pesak sand	antracite sivoanthracite	22,40 €



600-00501



600-00515



Šifra /code	Opis /description	Cena/price
600-00501	Telo usisne mlaznice sa dodacima / return fitting body with inserts	6,60 €
600-00515	Telo usisne mlaznice bez dodataka / return fitting body without inserts	5,40 €
600-811656	Matica sa navojem 2" / Nut thread 2"	4,50 €
1034011	Set prirubnica, zaptivke i vijci serie REAL ya uklapanje	6,20 €
1034012	Set prirubnica, zaptivki i vijaka serie REAL auto navojne za uklapanje	6,10 €

SET PREKRIVKI PRIRUBNICE I KRUŽNI poklopac

Šifra/code	Opis /description	Cena/price
1034014	Set prekrivki prirubnice i krug serie REAL belo	6,40 €

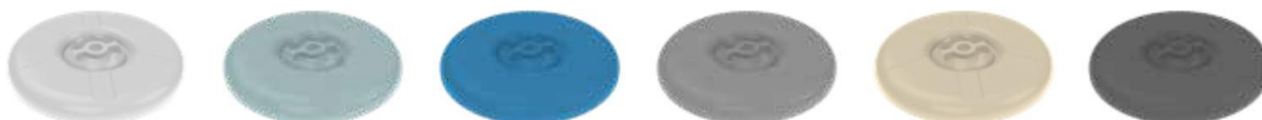

Šifra /code	1034015	1034016	1034017	1034018	1034019	Cena/price
Boja/color	svetlo plava lightblue	plava blue	siva grey	pesak sand	antracite greyanthracite	7,60 €

POKLOPAC OD 1,5"

šifra/code	Opis/description	Cena/price
600-811661	Poklopac 1,5 " bianco	5,40 €



Šifra/code	600-811665	600-811666	600-811667	600-811668	600-811669	Cena/price
Boja/color plava	svetlo lightblue	plava blue	siva grey	pesak sand	antracite sivoanthracite	4,90 €

SLIVNIK ANTIVORTEX / ANTIVORTEX MAIN DRAIN



Podni slivnik saobrazan normativima, prikladan za javne i privatne bazene isporučen sa antivortex rešetkom. Sa mesinganim umetcima sa navojem, u ABS sa tretmanom anti-UV, spoj bočni izlaz 2" ženski. Set rešetke sadrži rešetku, dihtung, flanšu i šrafove.

Main drain compliant with standards, suitable for installations in public and private swimming pools, equipped with anti-vent grid. With threaded brass inserts, in ABS with anti-UV treatment, 2" female side outlet connection.

Grille kit includes grille, gasket, flange and screws.



Šifra /code	Opis /description	Cena/price
1070033	Glavni slivniksa rešetkom ANTIVORTEXbeli zaliner Maindrain withANTIVORTEX white grid for liner	52,60 €



Šifra /code	1070038	1070039	1070042	1070043	1070044	Cena/price
Boja/color	svetlo plava	plava blue	pesak sand	sivo grey	antracite greyanthracite	56,60 €

REZERVNI DELOVI/ SPARE PARTS

SET REŠETKA ZA ANTIVORTEX SLIVNIK

Šifra /code	OPIS /description	Cena/price
1072285	Bela rešetkaza slivnik dnaANTIVORTEX White grid for main drainANTIVORTEX	19,50 €
1072276	Set Bela rešetka za slivnik dna ANTIVORTEX sa dihtunzima,prirubnicom,rešetkom I šrafovima White grid kit for ANTIVORTEX main drain with con gaskets ,flange,grid screws	31,80 €

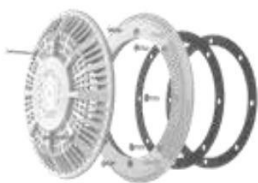

Šifra /code	1072271	1072272	1072274	1072273	1072275	Cena/price
Boja/color	celest lightblue	plava blue	sivo grey	pesak sand	antracite grey anthracite	35,80 €

PODNI SLIVNICI SA RAVNOM REŠETKOM GM-30 MAIN DRAIN GM-30 FLAT GRIP

NEW



Podni slivnik sa ravnom rešetkom*, od ABS sa UV obradom, pogodan za ugradnju u javne i privatne bazene. Sa navojnim mesinganim umetcima, od ABS-a sa anti UV tretmanom. 2" bočni izlazni priključak sa ženskim navojem. Set rešetke uključuje rešetku, dihtung, prirubnicu i šrafove.

*Main drain with flat grid *, in ABS with UV treatment, suitable for installations in public and private swimming pools. With threaded brass inserts, in ABS with anti-UV treatment. 2 "female threaded side outlet connection. Grille kit includes grille, gasket, flange and screws.*



Šifra /code	Opis/description	Cena/price
1070347	Podni slivnik GM-30 belisa ravnom rešetkom za liner*/Whitemain drain GM-30 with flat grid for liner*	42,00 €

** conformità garantita unicamente dall'installazione di due unità in parallelo/ compliance guaranteed only by installing two units in parallel*



Šifra/code	1070348	1070349	1070350	1070351	1070352	Cena/price
Boja/color	sv. plav light blue	plava blue	sivo grey	pesak sand	antracite grey anthracite	46,50 €

IMPIANTO/EQUIPMENT

Rezervni delovi / SPARE PARTS

SET REŠETKA ZA DONJI SLIVNIK GM-30

Šifra /code	Opis /description	Cena/price
1070011	Ravna bela rešetka za podni slivnik/White flat grid for main drain	16,00 €
1070353	Set bela rešetka za podni slivnika sa zaptivkom, prirubnicom, rešetkom i vijcima/White grid kit for main drain with gaskets, flange, grid screws	29,90 €



Šifra /code	1072330	1072331	1072333	1072332	1072334	Cena/price
Boja/color plava	svetlo light blue	plava blue	sivo grey	pesak sand	antracite grey anthracite	34,10

USISAVANJE ZA HIDROMASAŽNI UREĐAJ GM-9 SUCTION
FOR HYDRO INSTALLATIONS GM-9

REAL

NEW



Usisna mlaznica, za zid ili pod, pogodna za sve strukture i obloge, membrana/lajner i beton, sa umetcima od mesinga, priključak za lepljenje od Ø63 mm ili spoljni navoj od 2.5".

Suction, for wall or bottom, suitable for all types of structures and coatings, membrane / liner and concrete, with brass inserts, Ø63 mm bonding connection or 2.5 male thread.



Šifra /code	Opis /description	Cena/price
1070740	Usisna mlaznica bez matice za zatezanje GM-9 bela Suction without tightening nut GM-9 white	29,80 €



Šifra /code	1070741	1070742	1070743	1070744	1070745	Cena/price
Boja/color	Svetlo plave	Plavo blue	sivo grey	pesak sand	antracite grey anthracite	32,80 €

Šifra /code	Opis /description	Cena/price
-------------	-------------------	------------



Usisavanje, za zid ili pod, pogodna za svaku strukturu, čelični panel, kade od fibreglasa i obloge, membrana/lajner i beton, sa mesinganim umetcima, priključak za lepljenje od Ø63 mm ili muški navoj od 2.5".

Suction, for wall or bottom, suitable for any structure, steel panels, fiberglass tanks and coatings, membrane / liner and concrete, with brass inserts, Ø63 mm bonding connection or 2.5 male thread.



Usisavanje sa zateznom maticom GM-9 bela
Suction without tightening nut GM-9 white

32,80 €



Šifra/code	1070342	1070343	1070344	1070345	1070346	Cena/price
Boja/color	sv.plav lightblue	plavo blue	sivo grey	pesak sand	antracite grey anthracite	37,60 €

REZERVNI DELOVI ZA USISAVANJE GM-9/ GM-9 SUCTION SPARE PARTS

SET ŠRAFOVA, PRIRUBNICA, ZAPTIVKA I ZATEZNA MATICA



Šifra /code	Opis /description	Cena/price
600-120001	Set šrafova, prirubnica i dihtunzi GM-9 kitscrews, flange and gaskets GM-9	22,50 €
600-00514	Zatezna matica GM-9 / GM-9 Nut	9,80 €

USISNA REŠETKA ZA HIDROMASAŽU

ŠIFRA/code	OPIS/description	Cena/price
1070074	Rešetka bela za hidro uređaj GM-9 bela/ Grid for hydro installations GM-9 white	6,80 €



Šifra /code	1070075	1070076	1070077	1070079	1070080	cena/price
Boja/color	sv.plav lightblue	plavo blue	sivo grey	pesak sand	antracite grey anthracite	8,10 €

ABS SKIMER ZA LAJNERE / ABS SKIMMER FOR LINER



Skimeri se mogu isporučiti sa poklopcem i prstenom boje peska

Isporučeno sa: zaptivkom od lepljive gume, 2 bočna izlaska za lepljenje Ø63 (omogućavaju postavljanje regulatora nivoa ili preliivanja), lepljivu zaštitu za gradilište, korpica sa spojem na telo skimera, samoblokirajući poklopac, priključak sa navojem za cevi 1 1/2" e 2", ram poklopca sa regulacijom po visini za nivo pločica, prelivna cev Ø50, plastični štapić korpice, prekrivka prirubnice, mogućnost da sadrži jedan regulator automatski nivoa, debljaker poklopca, stopira poklopac i smanjuje buku, mogućnost fiksiranja na tanki zid ili prefabrikovani panel.

Supply of: rubber adhesive, 2 side outlets Ø63 to glue (allowing the installation of level controller or a too-full), adhesive backing, for construction site, joint basket in the skimmer body, self-locking lid, hose threaded 1 1/2" and 2", frame cover adjustable in height to the level tiles, overflow pipe Ø50, rod of plastic basket, cover flange, possibility of contain an automatic level control, stop locking wing, the tab stops and minimizes the noise, the possibility of fixing on thin wall or prefabricated panels.



cod.1070008



cod.1070230



cod.1070217

Šifra/ code	Opis/description	Cena/ price
1070007	Skimer sa standardnim otvorom+produžetak dubine186mm-rif.C-111-M/Skimmerstandardmouth+extension throat 186 mm - ref. C-111-M	229,20 €
1070008	Skimer sa proširenim otvorom+produžetak dubine 331mm-rif.C-115-M/Skimmerstandardmouth+extension th roat 331 mm - ref. C-115-M	261,70 €
1070009	Skimer sa proširenim otvorom dubina 186mm-rif.C-117-M/Skimmerwidemouth+extensionthroat186 mm-ref. C-117-M	269,30 €
1070230	Skimer sa proširenim otvorom+produžetak dubina330mm-rif.C-119-M sa mesing umetcima/Skimmerwide mouth + extension throat 330 mm with brass inserts - ref. C-119-M	213,20 €
1070217	Skimer ONE prelivni sa proširenim otvorom+produžetak-rif.C-119-Mi-Mrcon/OverflowskimmerONEwith wide mouth + extension throat with brass inserts - ref. C-119-Mi-MR	253,50 €
1070016	Skimer automatska prekrivka,liner+2produžetka/Skimmerforautomaticcover,liner,2extensionthrow457 mm - ref. C-119CA-M-2	603,30 €
1070212	Skimmer automatska prekrivka, lajner, ONE prelivni + 2 produžetka- rif. C-119-CA-MR / Skimmer for automatic cover, liner, ONE overflow, 2 extension throw - ref. C-119-CA-MR	461,40 €

SKIMMER ZA PANELNE BAZENE/ SKIMMER FOR PANELS



cod.1070220

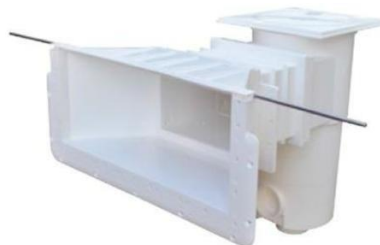

cod.1070216

Šifra / code	Opis /description	Cena/ price
1070216	Skimer ONE prelivni za panel bazene/liner-/OverflowskimmerONEforpanel/linerpool-ref.C-119-P-MR	473,90 €
1070220	Skimer proširenog otvora za panel bazene/liner - rif. C-117-P / Skimmer a bocca svasata per piscina pannelli/ liner - rif. C-117-P	286,50 €
1070213	Sandwich zaptivke / Sandwich seal	21,20 €

SKIMER MATCH / MATCH SKIMMER



NEW

Šifra/code	Opis /description	Cena/price
1070270	Skimer Match beli sa umetcima/WhiteMatchskimmerwithinserts	356,40 €
1070271	Skimer Match Beli prelivni sa umetcima/Matchwhitewaterlineskimmerwithinserts	513,50 €

SKIMER ARMONIA PERFETTA
COLORED SKIMMER

Komponujte Vaš bazen spajajući obloge sa zidnom opremom. Boje u u savršenoj harmoniji koje daju suptilnu estetiku, ili personalizaciju i dinamiku, igrajte se kontrastima.

Compose your pool accessories matching the lining and the accessories. The colors blend perfectly, giving a refined aesthetic. Or for customization and dynamism, play with contrasts.



Svetlo plava
light blue



plava
blue



pesak
sand



sivo
grey



sivo antracite
grey anthracite



crno
black

Skimmer raširenog otvora + produžetak - bojeno /Colored wide mouth skimmer + extension throat

Šifra/code	1072000	1072010	1072030	1072040	1072110	1072050
Boja/color	Svetlo plava/ light blue	plava/ blue	pesak/sable	siva/ gray	antracite/ anthracite	crna/ black
Cena/price	308,90 €	308,90 €	308,90 €	308,90 €	308,90 €	308,90 €

Skimer ONE prelivni širokog otvora+produžetak-bojen/ColoredwidemouthskimmerONE+extensionthroat

Šifra/code	1072160	1072158	1072164	1072161	1072163	1072162
Boja/color/ Cena/price	svetlo plavi 460,70 €	plavi/ blue 460,70 €	pesak/sable 460,70 €	siva/ sivo 460,70 €	antracite/ anthracite 460,70 €	crno/ crno 460,70 €

ZIDNA OPREMA STANDARD

PREKRIVENI RAM BOJEN PERFEKTNA HARMONIJA, SA BOJENIM POKLOPCEM COVER FRAME COMPLETE WITH FLAP



Svetlo plava
light blue



plavo
blue



pesak
sand



sivo
grey



crno
black



plavo sivo
blue grey



sivo antracite
anthracite grey



glina
clay

za skimmer širokog otvora/for wide mouth skimmer

Šifra/ code	1072120	1072121	1072123	1072124	1072125	1072126	1073127	1072108	Cena/ price
Boja/ Color	Svetlo plava	plavo/	pesak/	sivo/gray	antracite/	crno	sivo plavo	glina	62,70 €

za skimmer one/ for skimmer one

Šifra/ code	1072167	1072165	1072171	1072168	1072170	1072169	1072148	1072151	Cena/ price
Boja/ Color	Svetlo plava	plava/ blue	pesak/ sable	sivo/gray/	anthracite	crno/black	/plavogray	glina/clay	65,10 €

PRIRUBNICA, REŠETKA I DIHTUNZI ARMONIA PERFETTA MLAZNICA C-319 COLORED FLANGES, GRATINGS AND GASKETS JET C-319

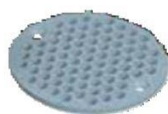

Svetlo plavo
light blue



sivo antracite
grey anthracite

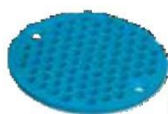

plavo
blue



crna
black



pesak
sand

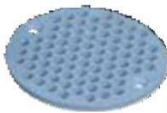

plavo sivo
blue grey



sivo
grey



glina
cl

Flanša, rešetka i dihtunzi za mlaznicu C-319- bojena / flange, gratings and gaskets for jet C-319 colored

Šifra/ code	1072260	1072261	1072263	1072264	1072265	1072266	1072267	1072269	Cena/ price
Boja/ Color	Svetlo plava blue	plava/ blue	pesak/ sable	sivo/gray	anthracite	crno/black	b. grigio/b.gray	glina/clay	29,80 €

REGULATOR NIVOVA / MECHANICAL FLOAT LEVEL CONTROLLER



Mehanizam punjenja; poklopac i ram identicni skimeru; brzina spajanja Ø50/63. Regulatori nivoa su kompletni sa unutrašnjim mehaničnim plovkom, koji se demontira iznutra.

Loading mechanism, cover and frame identical to the skimmer; fast jointing Ø50/63. The level regulators are equipped with internal mechanical floating, removable from the inside.

Šifra /code	Opis/description	Cena/price
1070110	Regulator nivoa kompletan sa hidrauličnim plovkom 3/8 Mechanical float level controller with floating hydraulic	125,70 €

SKIMER DELOVI / SKIMMER ACCESSORY



šifra /code	opis /description	Cena/price
1070222	Kompenzator prsten Compensator collar	29,00 €

ZIDNI PRODORI U ABS / THROUGHWALL FLANGE IN ABS



Šifra /code	Opis /description	Cena/price
1070061	Univerzalni zidni prodord a250mm/universal throughwall flange	19,20 €

USISNE MLAZNICE SERIJE CP-3 / RETURN FITTINGS CP-3



cod. 1072307

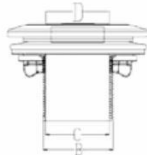
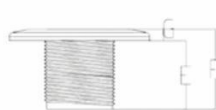

DIMENZIJE / DIMENSIONS

A mm	B mm	C mm	D mm
118,9	2"	50	53,9
E mm	F mm	G mm	
56,65	66,75	9,90	

Šifra / code	Opis /description	Cena/price
1072307	Zidna usisna mlaznica sa navojem 2" spoljni - preč.50 unutrašnji na lepljenje – sa steznim prstenom,prirubnicom, zaptivkama i vijcima inox za držanje nepromočive membrane za betonske bazene/lajner/ Tanki zid mlaznica prečn.20 mm / Return fitting to wall threaded external 2" - bonding internal Ø 50 with flange, gasket and screws for waterproofing membrane for pool cement/liner- nozzle Ø 50	23,30 €



sivo grey



sivo antracite grey anthracite



svetlo plavo light blue



plavo blue



pesak sand

Šifra/code	1072301	1072302	1072303	1072304	1072305	Cena/price
Boja	sivo grey	antracite grey anthracite	svetlo plava light blue	plava blue	pesak sand	23,70 €

USISNA MLAZNICA SA ČEPOM SERIE CP-3 / VACUUM POINT CP-3



cod. 1072315

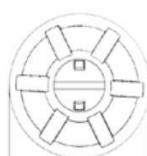
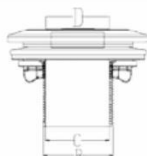

DIMENZIJE/ DIMENSIONS

A mm	B mm	C mm	D mm
118,9	2"	50	53,9
E mm	F mm	G mm	
56,65	66,75	9,90	

Šifra /code	Opis /description	Cena/price
1072315	Usisna zidna mlaznica sa čepom i navojem 2" spoljnim - preč.50 unutra. Na lepljenje – sa steznim prstenom, prirubnicom, zaptivke i vijci inox za držanje nepromočive membrane za betonske bazene/lajner/ Tanki zid mlaznica preč.20 mm / Vacuum point to wall threaded external 2" - bonding internal Ø 50 with flange, gasket and screws for waterproofing membrane for pool cement/liner- nozzle Ø 50	21,40 €



sivo grey



sivo antracite grey anthracite



svetlo plava light blue



plava blue



pesak sand

Šifra/code	1072316	1072317	1072318	1072319	1072320	Cena/price
Boja	sivo grey	antracite grey anthracite	svetlo plava light blue	plava blue	pesak sand	22,50 €

POTISNE I USISNE MLAZNICE/ RETURN FITTING IN ABS FOR LINER

Regulisanje podesivog mlaza, jednostavno i vrlo brzo. Bez ispusta bilo kojeg dela sa podesivim mlazom (estefika i komotna upotreba).
Vijci za stezanje zaptivke potpuno maskirani ramom podesivog mlaza. 4 dodatnih umetaka za zaptivanje uključeni (pored onih 4 isporučenih za instalaciju) od velike koristi u slučaju eventualne zamene ili demontaže zaptivke. Dve mogućnosti spoja za istu cenu fi 50 na lepljenje (un) i 2" sa navojem (spoljnim).



Šifra 1070168



Šifra 1070073



šifra 1070071



Šifra 1071172



Šifra 1070252

Šifra /code	Opis /description	Cena/price
1070168	Mlaznica sa mesinganim umetcima, za panel/liner, sa maticom / Return fitting with insert and jet, for panel/liner, with nut	65,00 €
1070073	Mlaznica sa podesivim mlazom za bazen tankog zida, zaptivnom maticom i prirubnicom / Return fitting with orientable jet for pool with thin wall, tightening nut and flange	51,60 €
1070071	Mlaznica usisno/potisna sa rešetkom 2" Ø 63 na lepljenje, liner / Bonding return fitting with aspiration/expiration grid	27,30 €
1070252	Mlaznica sa rešetkom usisna 2 1/2 / 63, rešetka 162 mm, liner / Return fitting with aspiration grid 2 1/2 / 63, grid 162 mm, liner	73,00 €
1071172	Mlaznica sa rešetkom usisna za pod i zidove 3" Ø 90 na lepljenje, liner / Bonding return fitting with aspiration/expiration grid	240,60 €

DELOVI MLAZNICA RETURN FITTING ACCESSORIES



Šifra 1070090



Šifra 1070091



cod.1070092



cod.1070093

Šifra/code	Opis /description	Cena/price
1070090	Podesivi mlaz Ø 23 mm za mlaznice / orientable jet for return fitting	13,30 €
1070091	Čep sa navojem 1 1/2 con guarnizione torica / threaded cap with gasket	12,00 €
1070092	Čep sa navojem za mlaznice, beli / white threaded cap for return fitting	9,70 €
1070093	Prodor mlaznice sa čepom sa navojem Ø 38 x 1 1/2 / swivelling barbed end-piece	15,40 €

FIKSNI REFLEKTORI / FIXED UNDERWATER LIGHT



Leppljiva zaštitna zaptivka za gradilište; zavrtanje sijalice na bajonet bazu, ne izlazi iz svog ležišta; laka demontaža; specifično podvodno kablo dužine 2,20 m koje omogućava jednostavnu zamenu sijalice; ; uscita

del cavo di alimentazione superiore, cavo semi-rigido regolabile e pressacavo di sicurezza; possibilità di fissaggio su parete prefabbricata; sistema auto-bloccante di chiusura del coperchio con guarnizione OR per maggiore tenuta e sicurezza; consegnate con pressacavo a tenuta rapida.

Adhesive gasket for protection site; lock of the lamp; easy removal of the lamp; specific underwater cable m 2.20, which allows a facilitated exchange of the lamp; output of the power cord, rigid adjustable cable and safety cord-locks; possibility of fixing on prefabricated wall; self-locking system closure of the cover with O-ring seal for greater and security, delivered with rapid-tight cord-lock.

Šifra /code	Opis /description	Cena/price
	FIKSNI REFLEKTOR ABS A LED ZA LINER / FIXED LED UNDERWATER LIGHT IN ABS FOR LINER	
1070224	reflektor liner a 60 LED bele boje 13,5W 12V ac, fiksiranje vijcima sa umetcima od mesinga White led for liner, fixed with screw, with brass inserts	253,10 €
1070225	Reflektor liner a 90 LED RGB 16W 12V ac sa daljinskim, fiksiranje vijcima sa umetcima od mesinga RGB led for liner, fixed with screw, with remote control, with brass inserts	378,40 €
1070214	Zaptivka sandwich za reflektor serie standard / Sandwich gasket for standard series projector	20,50 €



Pesak
sand



sivo
grey



sivo antracite
grey anthracite



plava
blue



svetlo plava
light blue

Reflektor za liner LED bela boja 13,5 W - 12 V ac, fiksiranje vijčano-obojeno / white underwater light for liner with screw

Šifra/code	1072178	1072175	1072177	1072174	1072172
Boja/color	pesak/sable	sivo/gray	antracite/anthracite	svetlo plava/light blue	plava/blue
cena/price	291,10 €	291,10 €	291,10 €	291,10 €	291,10 €

Reflektor za lajner LED RGB 16W - 12V ac sa , fiksiranje vijčano-obojeno / RGB underwater light for liner with screw

Šifra/code	1072036	1072046	1072116	1072006	1072016
Boja/color	pesak/sable	sivo/gray	antracite/anthracite	Svetlo plava/light blue	plava/blue
Prezzo/price	416,30 €	416,30 €	416,30 €	416,30 €	416,30 €

RAZVODNE UNIVERZALNE KUTIJE / UNIVERSAL DECK BOXES



- Dimenzije 13,5x13,5 cm
- Boje bela i pesak
- Montaža serijska ili paralelna, savršena zaptivenost i regulisanje dužine kabl

- Dimensions 13,5x13,5 cm
- White and sand color
- Mounting in series or parallel, perfect fit and adjustment of cable length

NEW

Šifra /code	Opis/description	Cena/price
1070051	Univerzalne razvodne kutije bela / Universal deck boxes white	22,60 €
1070052	Univerzalne razvodne kutije pesak / Sand universal deck boxes	32,00 €

MINI REFLEKTOR SERIJE MT-4 DA ŠRAFITI NA JEDNU MLAZNICU MINI UNDERWATER LIGHT MT-4 TO SCREW IN A RETURN FITTING



Ravni led reflektor zašrafiti na prodor 1¹/₂; ujednačena podela svetla, skladna, ne zaslepljujuća; telo lampe urađeno ubrizgavanjem polikarbonata I ABS koji mu omogućava veliku otpornost na udar, toplotu I hemijsku agresivnost proizvoda za tretman vode;

Napajanje 12V ac 50-60 Hz preko toroidnog zaštićenog transformatora; kablaja 2x1.5mm. isporuka bez kabela; mogućnost sinhronizacije za sisteme sa više lampi; realizacija sistema sa više reflektora sa centralom na daljinsko upravljanje sa 1 ili 4 kanala; treba predvideti prodor od 1¹/₂.

Flat led underwater light screwed on to in a 1¹/₂ return fitting; distribution of homogeneous light, harmonious and not blinding for the swimmers; body-lamp made for injection of polycarbonate and ABS, which ensures high resistance to shock, heat and chemical attack of water treatment products; 12V ac 50 ~ 60 Hz to be provided by a toroidal protected transformer; wiring 2x1, 5 mm, supplied without cable; synchronization capabilities for multi-lamp systems, construction of multi-projector systems with control remote control to 1 or 4 channels; it is necessary to provide a return fitting 1¹/₂.

Instalacija sa proizvodom cod.1070065

To be installed with product
code 1070065

VERZIJE NA RASPOLAGANJU / VERSIONS AVAILABLE

- Lampa led univerzalna monohromatična bele boje (7000/8000°K) csa funkcijom ON/OFF
- Univerzalna led lampa višebojna RGB sa funkcijom ON/OFF
- 11 fiksnih boja I 5 automatskih programa.
- Universal Monochrome LED lamp in white (7000/8000 ° K) with ON/OFF
- Universal LED multicolour RGB lamp with ON/OFF
- 11 fixed colors and 5 automatic programs

Šifra /code	Opis/description	Cena/price
1070171	Mini reflektor led RGB 36 LED 6,8 W - 12 V ac / mini RGB led underwater light 36 LED 6,8 W - 12 V ac	138,00 €
1070172	Mini reflektor led beli 12 LED 4,0 W - 12 V ac / mini white led underwater light 12 LED 4,0 W - 12 V ac	98,30 €

RAVNI REFLEKTOR SERIJE MT-4 ŠRAFITI NA JEDNU MLAZNICU FLAT UNDERWATER LIGHT MT-4 TO BE SCREWED ON A RETURN FITTING



Telo reflektora urađeno do polikarbonata i ABS
Sa velikom otpornošću na udar, toplotu I hemijsku agresiju
proizvoda za tretman vode;
napajanje 12V ac 50-60 Hz preko toroidnog zaštićenog
transformatora; kablaja 2x1,5 mm, isporuka bez kabela;
mogućnost sinhronizacije za sisteme sa više sijalica; realizacija
sistema sa više reflektora sa centralom na daljinsku kontrolu sa 1
ili 4 kanala; dimenzije: Ø 290 mm, L 60 mm.

Projector-body made of polycarbonate and ABS with
high resistance to shock, heat and chemical attack
of water treatment products; 12V ac 50 ~ 60 Hz to be
provided by a toroidal transformer protected; wiring
2x1,5 mm, supplied without cable; synchronization
capabilities for multi-lamp systems, construction of
multi-projector systems with remote control with 1 or 4
channels; dimensions: Ø 290 mm, L 60 mm.

VERZIJE NA RASPOLAGANJU

- Monohromatski univerzalni led bela boja (6500°K) sa funkcijom ON/OFF
- Univerzalni višebojni led RGB sa funkcijom ON/OFF I tipkanje na prekidač ili daljinsko dotirano upravljanje
- 11 fiksnih boja i 5 automatskih programai

AVAILABLE VERSIONS

- Universal led underwater light, color white (6500°K) with ON/OFF.
- Universal projector multicolor RGB LED with ON / OFF switching button or remote control.
- 11 fixed colors and 5 automatic programs

Instalacija sa proizvodom cod.1070065

Installing with product
cod.1070065

Šifra/ code	Opis /description	Cena/ price
1070166	Ravni reflektor 90 LED RGB 16,0W-12 V ac sa daljinskim / Flat underwater light 90 RGB LED 16,0 W - 12 V ac with rc	286,60 €
1070199	Ravni reflektor 90 LED RGB sa daljinskim - kutija 5 kom/ Flat underwater light 90 RGB LED with rc - box of 5 pcs	1.433,00 €
1070169	Ravni reflektor 60 LED beli 13,5 W - 12 V ac / Flat underwater light 60 white LED 16,3 W - 12 V ac	185,00 €
1070198	Ravni reflektor 60 LED beli - kutija 5kom / Flat underwater light 60 white LED - box of 5 pcs	925,00 €
OPREMA / accessories		
1070229	Maska hromirana eloksirana / mat metal crown	59,00 €
1070228	Maska sivo antracite / anthracite grey crown	30,40 €
1070211	Maska svetlo siva / light grey crown	30,40 €
1070227	Maska svetlo plava / light blue crown	30,40 €
1070226	Maska pesak / sand crown	30,40 €
600-11272	Maska belo / white crown	30,40 €



Šifra 1070229



Šifra 1070228



Šifra 1070211



Šifra 1070227



Šifra 1070226



600-11272

INSTALACIONA OPREMA ZA MINI REFLEKTORE I RAVNI REFLEKTOR - SERIJE MT-4 INSTALLATION ACCESSORIES FOR MINI AND FLAT UNDERWATER LIGHTS - SERIE MT-4

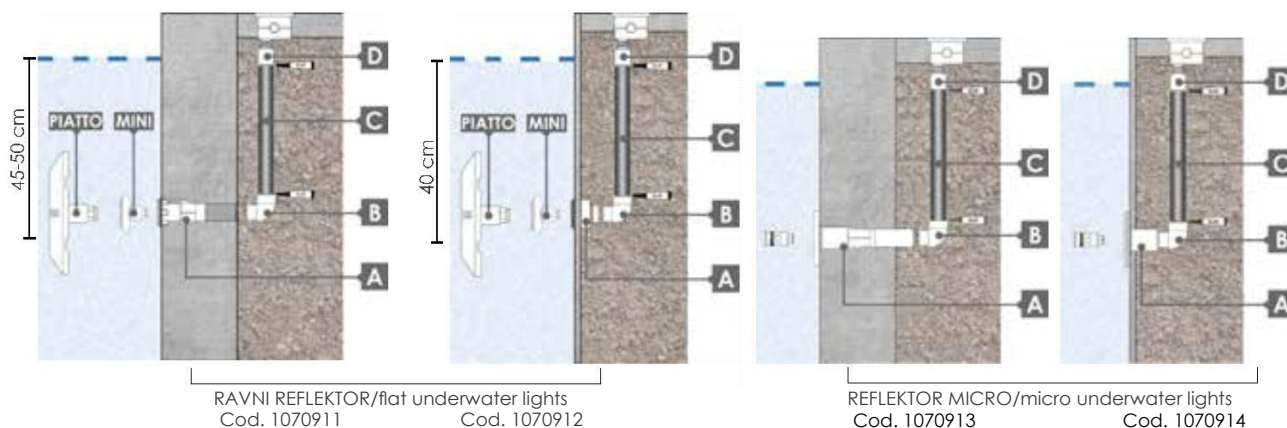

RAVNI REFLEKTOR/flat underwater lights
Cod. 1070911

Cod. 1070912

REFLEKTOR MICRO/micro underwater lights
Cod. 1070913

Cod. 1070914

Šifra /code	Opis /description	Cena/price
RAVNI REFLEKTOR I MINI		
1070911	Set za instalaciju ravni reflektor i mini za c.a./liner / Mini and flat underwater light installation kit - c.a./ liner	76,20 €
1070912	Set za instalaciju ravni reflektor i mini za panele/ Mini and flat underwater light installation kit - panels	67,50 €
REFLEKTOR MICRO		
1070913	set za instalaciju reflektor micro per c.a./liner/Micro projector installation kit - c.a./ liner	77,70 €
1070914	Set za instalaciju reflektor micro za panele / Micro projector installation ki	68,50 €



Cod. 1070065



Cod. 1070206



Cod. 1070235

RICAMBIO / replacement		
1070235	Set adaptera ravnog reflektora / Flat underwater light adapter kit	26,00 €
1070065	Zidni prodor za reflektor za liner / Liner throghwall with flange for underwater light	21,50 €
1070206	Spoljno zatvaranje sa uvodnicom kabla Ø 50mm / Cap with cable gland Ø50mm	12,80 €

UNIVERZALNI INSTALACIONI SET UNIVERSAL INSTALLATION KIT

Kompatibilan sa nišama sledećih marki: Hayward, Kripsol, Seriefrance, BWT, Cofies.
Compatible with niches of the following brands: Hayward, Kripsol, Seriefrance, BWT, Cofies.



cod.1070194



cod.1070185

Šifra /code	Opis /description	Cena/price
1070809	Instalacioni univerzalni set beli / white universal installation kit	60,80 €
1070916	Univerzalni instalacioni set sivi / grey universal installation kit	60,80 €
1070917	Univerzalni instalacioni set pesak / sand universal installation kit	60,80 €
1070918	Univerzalni instalacioni set antracite / anthracite universal installation kit	60,80 €
1070920	Instalacioni univerzalni set svetlo plavi/ light blue universal installation kit	60,80 €
TELECOMANDI RADIO 4 PULSANTI / RADIO REMOTE CONTROL 4 BUTTONS		
1070194	Radio daljinski upravljač 4 prekidača - od 2020/ Radio remote control 4 buttons - from 2020	29,50 €
1070185	Radio daljinski upravljač 4 prekidača- do 2019 (do isteka zaliha) / Radio remote control 4 buttons - until 2019 (while supplies last)	30,50 €

NOVI INSTALACIONI SET UNIVERZALNI/NEW UNIVERSAL INSTALLATION KIT

Sa duplim pozicioniranjem sistema fiksiranja, za kompletnu kompatibilnost sa nišama sledećih marki: Hayward, Kripsol, Seriefrance, BWT, Pools, Cofies.

Compatible with double fastener placement for full compatibility with niches of the following brands: Hayward, Kripsol, Seriefrance, BWT, Pools, Cofies.

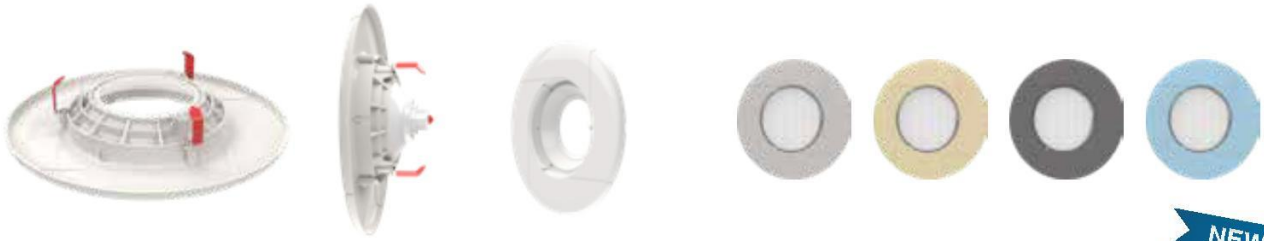

NEW

Šifra / code	Opis /description	Cena/price
1070922	Instalacioni univerzalni set beli new / new white universal installation kit	70,40 €
1070923	Instalacioni univerzalni set sivi new / new grey universal installation kit	70,40 €
1070924	Instalacioni univerzalni set pesak new / new sand universal installation kit	70,40 €
1070925	Instalacioni univerzalni set antracite new / new anthracite universal installation kit	70,40 €
1070926	Instalacioni univerzalni set svetlo plavi new / new light blue universal installation kit	70,40 €
1070921	Set za povezivanje kablova za renoviranje u sastavu 1 termoskupljajuće nepropomoćive izolacije od 40 cm, 2 konektora termoskupljajuća 1 kablo H07RNF 2x4mm ² od 40 cm Renovation cable connection kit including 1 waterproof heat-shrinkable sleeve of 40 cm, 2 heat-shrinkable connectors and 1 H07RNF 2x4mm ² cable of 40 cm	28,70 €

LAMPE LED KLASIČNE ZA UNIVERZALNI REFLEKTOR SERIE MT-4
LED CLASSIC LAMP FOR UNIVERSAL HEADLIGHT MT-4 SERIES

Telo lampe urađeno u polikarbonatu sa velikom otpornošću na udar, toplotu i agresiju hemijskih proizvoda za tretman vode. Terminali kablova na šaraf potpuno ugrađeni u telo lampe radi boljeg zaptivanja. Napajanje 12V ac 50-60 Hz putem toroidalnog zaštićenog transformatora. Kablovanje 2x1,5 mm². Mogućnost sinhronizacije za sisteme sa više lampi. Dimenzije: Ø 178 mm, L 90 mm.

Lamp housing made of polycarbonate with high resistance to shock, heat and chemical at of water treatment products. Screwed wiring, completely drowned in the lamp body for a better seal. 12V ac 50 ~ 60 Hz to be provided by a toroidal protected transformer. Wiring 2x1,5 mm². Possibility of synchronization for systems with lights. Dimensions: Ø 178 mm, L 90 mm.

VERZIJE NA RASPOLAGANJU

LED monokromatski bele boje (6500°K) sa funkcijom ON/OFF.

- LED višebojni RGB sa funkcijom ON/OFF i switching na dugme ili Doširanog daljinskog.
- 11 fiksnih boja i 5 automatskih programa.

VERSIONS AVAILABLE

Universal led lamp, color white (6500°K) with ON/OFF.

- Universal lamp multicolor RGB LED with ON / OFF switching button or remote control.
- 11 fixed colors and 5 automatic programs

Šifra /code	Opis /description	Količina/Qt/	Cena/price
1070157	Lampa za reflektor PAR56 90 LED RGB 16W 12V ac sa daljinskim / Lamp for underwater light PAR56 90 RGB LED 16W 12V w/remote control		216,20 €
1070802	Lampa za reflektor PAR56 90 LED RGB 16W 12V ac sa daljinskim / Lamp for underwater light PAR56 90 RGB LED 16W 12V w/remote control	12 pz 12 pcs	2.542,80 €
1070156	Lampa za reflektor PAR56 60 LED bele boje 13,5W 12V ac / Lamp for underwater light PAR56 60 white LED 13,5 W 12V ac		90,90 €
1070803	Lampa za reflektor PAR56 60 LED bele boje 13,5W 12V ac / Lamp for underwater light PAR56 60 white LED 13,5 W 12V ac	12 pz 12 pcs	1.040,70 €
1070927	Lampa za reflektor PAR56 90 LED bele boje CCT 16W 12V ac Sa radio prijemnikom / Lamp for underwater light PAR56 90 white LED 16W 12V w/remote control		204,30 €
1070928	Lampa za reflektor PAR56 60 LED boja čilibar 13W 12V ac / Lamp for underwater light PAR56 60 amber LED 13,5 W 12V ac		199,30 €
1070929	Lampa za reflektor PAR56 60 LED boja royal plava 13W 12V ac / Lamp for underwater light PAR56 60 royal blue LED 13,5 W 12V ac		195,90 €



CCT



Blue Royal



Čilibar

NEW

LAMPE LED SA NEPROPUSTIVIM KONEKTOROM ZA UNIVERZALNI REFLEKTOR SERIJE MT-4 LED LAMP WITH TIN CONNECTOR FOR UNIVERSAL HEADLIGHT MT-4 SERIES



Telo lampe realizovano od polikarbonata sa velikom otporom na udar, toplotu i hemijsku agresiju proizvoda za tretman vode .Priključak kablova nepromočiv. Napajanje 12V ac 50~60 Hz da sa napajanjem putem toroidnog transformatora zaštićenog. Kablaža 2x1,5 mm². Moguća sinhronizacija za sisteme sa više lampi. Dimenzioni: Ø 178 mm, L 90 mm.

Lamp shell made of polycarbonate with high resistance to shock, heat and chemical attack from water treatment products. Watertight wiring terminals. Power supply 12V ac 50~60 Hz to be supplied by protected toroidal transformer. 2x1.5 mm² wiring. Possibility of synchronization for multi-lamp systems. Dimensions: Ø 178 mm, W 90 mm.

VERZIJE NA RASPOLAGANJU

LED monohromatski bele boje (6500°K) sa funkcijom ON/OFF.

- LED više boja RGB sa funkcijom ON/OFF pritiskom na dugme ili daljinskim.
- 11 fiksnih boja i 5 automatskih programa.

VERSIONS AVAILABLE

Universal led lamp, color white (6500°K) with ON/OFF.

- Universal lamp multicolor RGB LED with ON / OFF switching button or remote control.
- 11 fixed colors and 5 automatic programs

Šifra/code	Opis /description	Cena/price
1070165	Lampa za reflektor PAR56 90 LED RGB 16W 12V ac sa daljinskim Lamp for underwater light PAR56 90 RGB LED 16W 12V ac with rc	242,90 €
1070152	Lampa za reflektor PAR56 60 LED bela boja 13,5W 12V ac Lamp for underwater light PAR56 60 white LED 13,5W 12V ac	129,30 €



REFLEKTORI MICRO SERIE MT-4 / MICRO PROJECTORS MT-4



Cod. 1070184 - 1070170



Telo reflektora realizovano u polikarbonatu za šrafljenje na prodoru 1 1/2", kablaze 2x1 mm, napajanje 12V ac 50~60 Hz, mogućnost sinhronizacije za sisteme sa više lampi ; dimenzije: Ø 49mm, L 102 mm.

Projector-body made of polycarbonate screwed on to in a 1 1/2" return fitting, wiring 2x1 mm, 12V ac 50 ~ 60 Hz power supply, synchronization capabilities for multi-lamp systems; dimensions: Ø 49 mm , L 102 mm

DIMENZIJE NA RASPOLAGANJU

- Univerzalna led lampa monokromatska bele boje (6500°K) sa funkcijom ON/OFF
- Lampa led univerzalna više boja RGB sa funkcijom ON/OFF
- 11 fiksnih boja i 5 automatskih programa

VERSIONS AVAILABLE

- Universal Monochrome LED lamp in white (6500°K) with ON/OFF
- Universal LED multicolour RGB lamp with ON/OFF
- 11 fixed colors and 5 automatic programs

Šifra /code	Opis /description	Cena/price
1070184	Reflektor micro a 9 led RGB 8,2 W - 12 V ac / micro 9 RGB led projector 8,2 W - 12 V ac	203,60 €
1070170	Reflektor micro a 18 led beli 6,0 W - 12 V ac / micro white 18 led projector 6,0 W - 12 V ac	151,90 €

ACCESSORI / accessories

Završna okrugla krunica
brzog učvršćivanja



Šifra /code	1070255	1070256	1070257	1070259	1070260	cena/price
Boja/color	bela white	svetlo siva light grey	tamno siva medium grey	pesak sand	svetlo plava light blue	13,10 €

Završna četvrtasta
krunica brzog
učvršćivanja



Šifra /code	1070261	1070262	1070263	1070265	1070266	cena/price
Boja/color	bela white	svetlo siva light grey	tamni siva medium grey	pesak sand	svetlo plava light blue	13,10 €

Završna metalik krunica
brzog fiksiranja



Šifra/code	1070258	1070264	Cena/price
Boja/color	metalik metalized	metalik metalized	37,40 €

KOMANDNA RADIO KUTIJA / RADIO CONTROL BOX



cod.1070196 cod.1070197

Na raspolaganju 1 ili 4 kanala, idealni dodatak za rasvetni uređaj bazena. Može kontrolisati jednu lampu ili upravljati celom rasvetnom opremom. Omogućava povezivanje do 12 reflektora bez prepravki električnog uređaja. Radio sistem garantuje odličan domet daljinskom. Elektronika je instalirana u nepromočivoj kutiji od ojačanog ABS za spoljnu upotrebu (IP65). Mogu se sinhronizovati svi reflektori (model 1 kanal) ili kreirati razne ambijente u boji u istom bazenu (model 4 kanala). Instalira se bez posebnih radova na električnom napajanju 12Vac reflektora. Svaka kutija poseduje konektore za kablo preseka do 4 mm.

Available in 1 or 4 channels, it is the ideal complement for a lighting system for pools. It can control a lamp or manage a global illumination system. It allows you to connect up to 12 projectors without major modification. The radio system provides an excellent range of the remote. Electronics installed in a box in ABS reinforced watertight for outdoor use (IP65). You can sync all projectors (model 1 channel) or create different colored in the pool (model 4 channels). It installs without any specific work on the power supply 12Vac of the projectors. Each box is provided with connectors for wire section up to 4 mm.

Šifra /code	Opis/description	Cena/price
1070192	Komandna radio kutija 1 kanal - do 12 reflektora - 12V ac radio control box 1 channel - up to 12 lights	125,10 €
1070193	Radio komandna kutija 4 kanala- do 27 reflektora - 12V ac radio control box 4 channels - up to 27 lights	192,90 €
ZAMENA/ replacement		
1070196	Daljinski sa 2 prekidača za radio komandne kutije 1 kanal 1070192 2 buttons remote control for control box 1 channel	29,50 €
1070197	Daljinski 8 prekidača za radio komandne kutije 4 kanala 1070193 8 buttons remote control for control box 4 channels	29,50 €
1070187	Daljinski 2 prekidača za radio komandne kutije 1 kanal fino do 2019 (dok traju zalihe) 2 buttons remote control for control box 1 channel	28,90 €
OPREMA/ accessories		
1070204	Set antena za radio komandnu kutiju 1 i 4 kanala sa kablom od 3 metra i seta za fiksiranje Kit antenna for radio control box 1 and 4 channels with cable 3 meters and fixing kit	43,90 €

REFLEKTOR A LED EXTRA RAVAN / EXTRA FLAT LED UNDERWATER LIGHT



Osmišljen za instalaciju bez radova ili specifične opreme, reflektor se pozicionira u svakoj vrsti bazena sa čvrstim zidom koji poseduje makar jednu potisnu mlaznicu sa unutrašnjim navojem 1" 1/2. Realizovan ubrizgavanjem polikarbonata i ABS, koji mu daju veliku otpornost na udar, toplotu i hemijske agresije proizvoda za tretman vode. Spreman za upotrebu, isporučuje se sa koferom opremljenim sa: kablom od 6 m, transformatorom 230V/12V ac (tip utičnice struje), radiofon daljinski i jedna usisna mlaznica sa unutrašnjim navojem od 1" 1/2.

Designed to installation without specific equipment, underwater light is placed in any type of pool that has a rigid wall with a return fitting with female threaded 1 "1/2. Realized by injection of polycarbonate and ABS which gives it a high shock resistance, heat and chemical attack of the products for water treatment. Ready to use, it is in a kit bag with: a 6 meter cable, a transformer type 230V/12V ac outlet, a radio remote control and an return fitting with female threaded 1 "1/2.

Šifra/code	Opis/description	cena/price
REFLEKTOR LED ZA NADZEMNE BAZENE / LED FOR ABOVE GROUND POOLS		
1070205	Reflektor 18 LED beli 9,7 W - 12 V ac / white light	165,40 €
1070125	Reflektor 36 LED RGB 7,8 W - 12 V ac con telecomando / RGB light with remote control	221,50 €
1070189	Transformator 230V/12V ac / transformer type	39,40 €
ZAMENA/ replacement		
1070186	Daljinski radio 4 prekidača/ radio remote control with 4 buttons	29,50 €

LAMPA DOPUNJIVA, VODOOTPORNA I MOBILNA / LAMP RECHARGEABLE, WATERPROOF AND MOBILE



100% vodootporna i mobilna, lampa na dopunu izvanredna je kako u bašti tako u bazenu. Dimenzije 115 mm. Pogodnosti:

- MOBILNA, zahvaljujući svojoj magnetnoj bazi, moguće je fiksirati bilo gde, takođe pod vodom.
- JEDNOSTAVNA ZA KORIŠĆENJE, samim pritiskom na centralni optički taster, moguće je paliti, gasiti i menjati boje
- PERFORMANSE, na raspolaganju u verzijama belo svetloiliRGB sa 7 boja i 3 programa.

100% waterproof and mobile, it makes ovunque light you need: in the garden, at home, in the pool. Dimensions 115 mm.

- MOBILE, thanks to its magnetic base, it secured everywhere, even under water
- EASY TO USE, by simply pressing the central button of optics you can turn on, turn off and change colors.
- PERFORMING, it's available in white light version or RGB version with 7 colors and 3 programs.

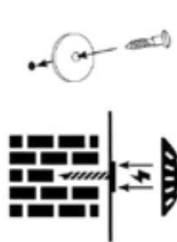

bela
white
cod.1070806



svetlo plava
light blue
cod.1070807



siva
grey
cod.1070808



plava
blue
cod.1070801

Sifra /code	Opis/description	Cena/price
1070805	Lampa dopunjiva, nepromočiva i mobilna, 18 LED bela Rechargeable,waterproof and mobile white 18 LED	79,60 €
1070806	Lampa dopunjiva, nepromočiva i mobilna, RGB, 18 LED, beli ram Rechargeable,waterproof and mobile, lamp RGB, 18 LED, white crown	79,60 €
1070807	Lampa dopunjiva, nepromočiva i mobilna, RGB, 18 LED, svetlo plavi ram Rechargeable,waterproof and mobile, lamp RGB, 18 LED, light blue crown	79,60 €
1070808	Lampa dopunjiva, nepromočiva i mobilna, RGB, 18 LED, sivi ram Rechargeable,waterproof and mobile, lamp RGB, 18 LED, grey crown	79,60 €
1070801	Lampa dopunjiva, nepromočiva i mobilna, RGB, 18 LED, plavi ram Rechargeable,waterproof and mobile, lamp RGB, 18 LED, dark blue crown	82,10 €



ZIDNA OPREMA

SKIMER SERIJE MT-3 U ABS ZA LINER I ZA BETONSKE BAZENE
SKIMMER MT-3 IN ABS FOR LINER AND FOR CONCRETE POOLS

Skimmer sa navojem 1 1/2" unutra, 2" spolja. Kompletirano sa flanšom, dihtunzima i inox šrafovima za dihtovanje nepromočive membrane za betonske bazene/liner

Skimmer with interior thread 1 1/2", outside 2". Complete with flanges, gaskets and screws for tightness of the waterproofing membrane for cement / liners pools

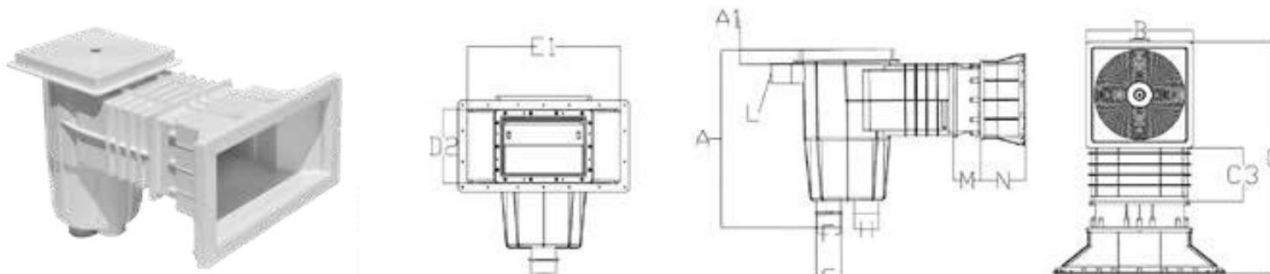

SKIMMER SA PROŠIRENIM OTVOROM SA PRODUŽETKOM / WIDE MOUTH SKIMMER WITH EXTENSION

DIMENZIJE / DIMENSIONS

A mm	A1 mm	B mm	C mm	C3 mm	D2 mm	E1 mm	F mm	G mm	H mm	L mm	M mm	N mm
416	25,31	248,90	565	137	172,50	358	50(1 1/2)	63 (2")	63 (2")	46	73	105

Šifra /code	Opis /description	Cena/price
2220109	Skimer sa proširenim otvorom sa mesinganim umetcima i produžetkom za zidove od betona rif.96511V wide mouth skimmer with brass inserts and extension for concrete walls	133,60 €
2220300	Skimer sa proširenim otvorom sa mesinganim umetcima +sendvič dihtungbazena u panelima wide mouth skimmer w/brass inserts and extension+seal sandwich	153,60 €
2220139	Set prirubnica+dihtunzi+šrafovi skimmer96511V-96501V/kitwithflange,sealandscrewsfor skimmer	23,50 €
2220200	Sendvič dihtung/ sandwich seal	20,00 €

SKIMMER SA STANDARDNIM OTVOROM / STANDARD MOUTH SKIMMER

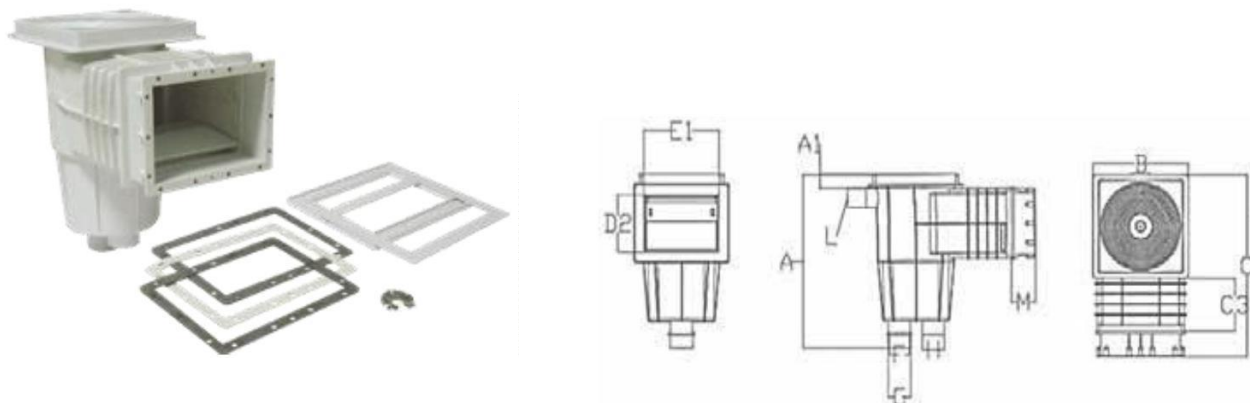

DIMENZIJE / DIMENSIONS

A mm	A1 mm	B mm	C mm	C3 mm	D2 mm	E1 mm	F mm	G mm	H mm	L mm	M mm
416	25,31	248,90	450,00	137,00	136,00	196	50 (1 1/2)	63 (2")	63 (2")	46	73

Šifra /code	Opis /description	Cena/price
2220133	Skimer sa standardnim otvorom sa mesinganim umetcima	99,30€
2220145	Skimer sa standardnim otvorom bez mesinganih umetaka	72,90€

ZIDNA OPREMA SERIJE MT-3

SKIMER SA MALIM OTVOROM / SMALL MOUTH SKIMMER

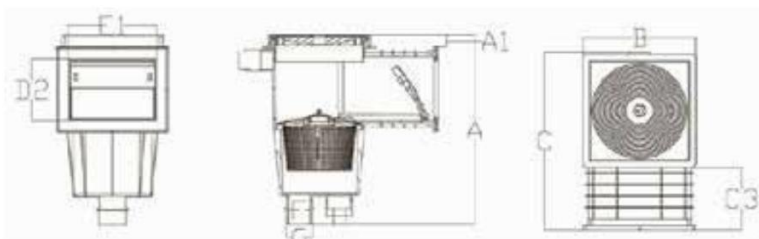

DIMENZIJE / DIMENSIONS

A mm	A1 mm	B mm	C mm	C3 mm	D2 mm	E1 mm	F mm	G mm	H mm	L mm
416	25,31	248,90	400,00	137,00	136,00	139,70	50(1½)	63(2")	63(2")	46

Šifra /code	Opis /description	Cena/price
2220146	Skimer sa malim otvorom sa mesinganim umetcima- smallmouth skimmerwithbrassinserts	94,30 €

PRELIVNI SKIMER LX7 / SKIMMER OVERFLOW LX7

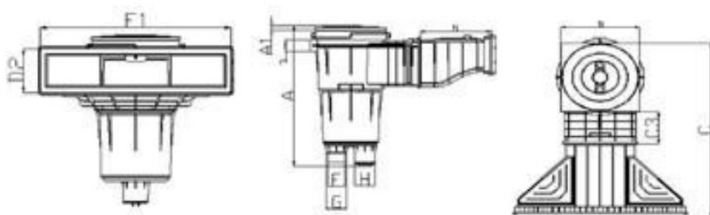

DIMENZIJE / DIMENSIONS

A mm	A1 mm	B mm	C mm	C3 mm	D2 mm	E1 mm	L mm	N mm	F mm	G mm	H mm
438.8	9.5	250.3	634	117.4	142.5	557	38	251,5	50(1½)	63(2")	63(2")

Šifre/code	Opis /description	Cena/price
2220144	Prelivni Skimer sa mesinganim umetcima za membrane i lajner Overflow skimmer with brass inserts for membrane and liner pools	193,40 €
1070811	Sendvič dihtunzi za skimmer LX7 Sandwich seal for LX 7 skimmer	22,10 €

BRIZGALICA SA ABS TEČNOŠĆU ZA POPRAVKE / SYRINGE IN ABS LIQUID FOR THE REPAIRS



BRIZGALICA ABS

Tečnost za popravku svih komada u ABS

ABS syringe of liquid for the repair of all parts in ABS

Šifra /code	Opis /description	Cena/price
1070023	Brizgalica sa ABStečnošću za popravku svih komada u ABS-syringe of liquid for the repair of all parts in ABS	56,80 €

MLAZNICE PODNE SERIJE MT-3 / BOTTOM INLET MT-3



cod.2220106

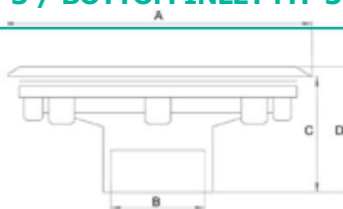

DIMENZIJE / DIMENSIONS

A mm	B mm	C mm	D mm
164,6	50	59,8	66,6



cod. 2220132



DIMENZIJE / DIMENSIONS

A mm	B mm	C mm	D mm	E mm	F mm
108	60	50	73,12	67,10	6,02

Šifra /code	Opis /description	Cena/price
2220106	Podna mlaznica sa navojem belapreč. unutar 50, spolja2", sa flanšom, dihtunzima i inox šrafovimama za držanje nepromočive membrane za betonske bazene/lajner/ floor inlet threaded internal diam. 50, external 2" with flange, gaskets and screws for waterproofing membrane for pool cement/liner	23,00 €
2220132	Podna mlaznica bela unutrašnjeg preč. 50 na lepljenje za betonske bazene/ Floor inlet internal diameter Ø 50 for pool cement/liner	7,30 €



sivo
grey



plavo
blue



sv.plavo
light blue



sivo antracite
grey anthracite



pesak
sand

Mlaznica podna sa navojem obojena / floor inlet threaded internal

Šifra/code	2220160	2220161	2220162	2220163	2220164	Cena/price
Boja/color	sivo/gray	antracite	Svetlo plava	plava/blue	pesak/sand	27,50 €

USISNA MLAZNICA SA PRODOROM SERIJE MT-3 / VACUUM POINT MT-3



cod.2220126

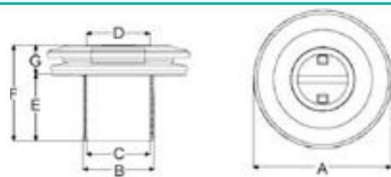

DIMENZIJE / DIMENSIONS

A mm	B mm	C mm	D mm	E mm	F mm	G mm
118,9	2"	50	53,9	55	78	23



cod.2220105

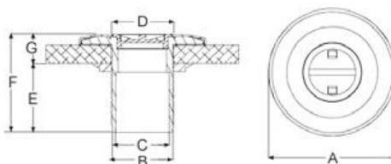

DIMENZIJE / DIMENSIONS

A mm	B mm	C mm	D mm	E mm	F mm	G mm
118,9	2"	50	53,9	55	66,55	9,90

Šifra/code	Opis /description	Cena/price
2220126	Usisna mlaznica sa prodorom i navojem 2" spolja, Ø50 unutar na lepljenje, sa flanšom, dihtunzima i inox šrafovimama za dihtovanje nepromočive membrane za betonske bazene/liner vacuum point to wall threaded external 2" - bonding internal Ø 50 with flange, gaskets and screws for waterproofing membrane for pool cement/liner	16,20€
2220105	Usisna zidna mlaznica sa navojem 2" spolja, Ø50 unutar na lepljenje sa prstenom za stezanje i dihtunzima za bazene od fibreglasa/vacuum point to wall threaded external 2" - bonding internal Ø 50 with with clamping ring and gaskets for vtr pools	7,60€

BOCCHETTE DI IMMISSIONE SERIE MT-3 / RETURN FITTINGS MT-3



cod. 2220100



cod. 2220101

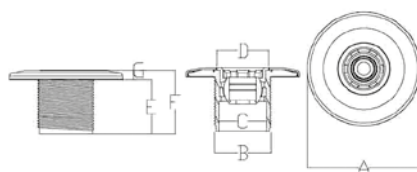

DIMENSIONI / DIMENSIONS

A mm	B mm	C mm	D mm
118,9	2"	50	53,9
E mm	F mm	G mm	
56,65	66,75	9,90	



cod. 2220102

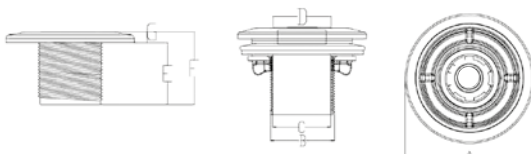

DIMENSIONI / DIMENSIONS

A mm	B mm	C mm	D mm
118,9	2"	50	53,9
E mm	F mm	G mm	
56,65	66,75	9,90	

Codice / code	Descrizione /description	Prezzo/price
2220100	Bocchetta di immissione a parete filettata 2" esterno - diam.50 interno a incollaggio per piscine cemento Return fitting to wall threaded external 2" - bonding internal Ø 50 for cement pool	5,60 €
2220101	Bocchetta di immissione a parete filettata 2" esterno - diam.50 interno a incollaggio - con anello di serraggio e guarnizioni per piscine in vetroresina - senza flangia di tenuta/ Return fitting to wall threaded external 2" - bonding internal Ø 50 with clamping ring and gasket for pool with thin wall - without air-tight flange	8,30 €
2220102	Bocchetta di immissione a parete filettata 2" esterno - diam.50 interno a incollaggio - con anello di serraggio, flangia, guarnizioni e viti inox per tenuta della membrana di impermeabilizzazione per piscine cemento/liner/parete sottile ugello diam.20 mm / Return fitting to wall threaded external 2" - bonding internal Ø 50 with flange, gasket and screws for waterproofing membrane for pool cement/liner- nozzle Ø 50	19,40 €

POZZETTI DI FONDO SERIE MT-3 / MAIN DRAIN MT-3



cod. 2220128

Codice / code	Descrizione /description	Prezzo/price
2220108	Pozzetto di fondo In ABS - diam. 170mm - uscita laterale filetto 2" con flangia, guarnizioni e viti inox per tenuta della membrana di impermeabilizzazione per piscine cemento/liner main drain in ABS Ø 170 mm- side exit threaded 2" with flange, gaskets and screws for waterproofing membrane for pool cement/liner	41,20 €
2220128	Kit rinnovamento pozzetto di fondo (griglia+flangia+guarnizioni+viti)/ main drain renovation kit (grid+flange+seal+screws)	16,60 €

DIMENSIONI / DIMENSIONS

Codice	A mm	B mm	C mm	D mm	E mm
2220108	167	229,5	118,95	63(2")	45

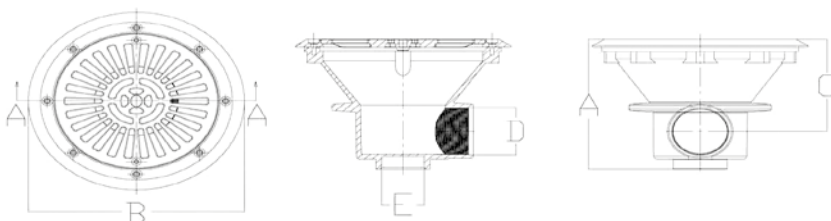

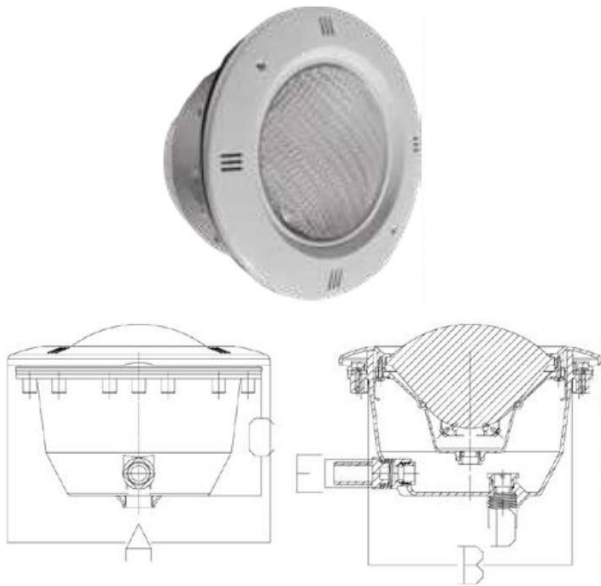
REFLEKTORI SERIJE MT-3
UNDERWATER LIGHT MT-3

- Reflektori za podvodnu rasvetu za ugradne bazene 300 Watt, 12 V
- Kompletirani sa kućištem, telom sijalice, flanšom, dihtunzima i inoxšarafima za držanje nepromočive membrane za betonske bazene/lajner. Umetci od mesinga.
- Underwater light for inground pools 300 Watt/12 V
- Complete with housing box, lamp-body, flange gaskets and screws for tightness of the waterproofing membrane for cement/liners pools. Brass Inserts.

DIMENZIJE / DIMENSIONS

A mm	B mm	C mm	D mm	E mm
279	218	124	¾"	¾"

Šifra/code	Opis/description	Cena/price
2220111	Reflektor za podvodnu rasvetu 300 watt 12V underwater light 300 watt 12 V	120,60 €
2220302	Reflektor za podvodnu rasvetu 300 watt 12V + dihtung sandwich underwater light 300 watt 12 V + seal sandwich	140,60 €
2220140	Set prirubnica + zaptivke + šrafovi i reflektor 96844V kit with flange, seal and screws for sunderwater light	14,10 €
1070047	Sijalica od 300 Watts 12 Volts, standard lamp 300 watts 12 V, standard	29,00 €
2220201	Zaptivka sandwich sandwich seal	20,00 €

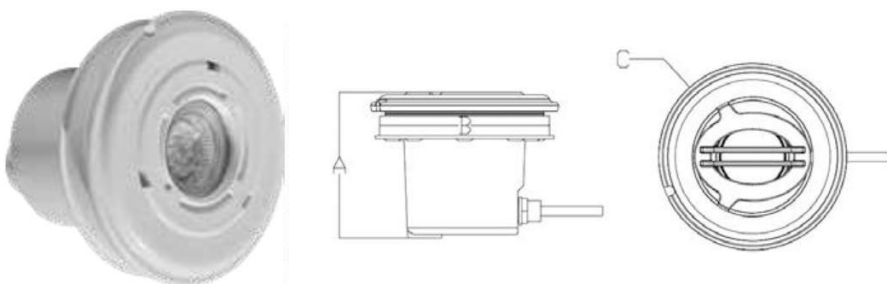
MINI REFLEKTORI SERIJE MT-3 ZA BETONSKE BAZENE I LINER
MINI UNDERWATER LIGHTS MT-3 FOR CONCRETE AND LINER POOL

DIMENZIJE / DIMENSIONS

A mm	B mm	C mm
127,30	147	163,20

Šifra /code	Opis /description	Cena/price
2220114	Mini rasvetni reflektor za male bazene 50 Watt/12V diam. 120mm, flanša, dihtunzi i šrafovi inox za pričvršćivanje nepromočive membrane za betonske bazene/lajner mini underwater light for small pools 50 Watt/12V Flanges, gaskets and screws for tightness of the waterproofing membrane for cement / liners pools	63,50 €
2220117	Miniled reflektor, preč. 120 mm, 18 jedinica led bele bojesa flanšom, dihtunzima i inox šrafovima za pričvršćivanje nepromočive membrane za betonske bazene/lajner-1,5 watt/12V mini LED underwater light Ø120mm, 18 white led units with flange, gaskets and screws for waterproofing membrane for pool cement/liner 1,5 watt/12V	67,00 €
2220130	Sijalica od 18 led bela 1,5 watt/12V lamp with 18 white led 1,5 watt/12V	10,20 €

MINIREFLEKTORSERIEMT-3ZA BAZENE OD PANELA I OD FIBERGLASA
MINI UNDERWATER LIGHTS MT-3 FOR PANEL AND FIBERGLASS POOL

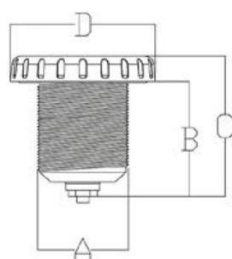

DIMENZIJE / DIMENSIONS

A mm	B mm	C mm	D mm
59	74,97	91,55	94,27

Šifra/code	Opis /description	Cena/price
2220124	Minirefleksor bez niše za spa kade ili stepenice poliester sa prestonom za zatezanje i dihtunzima 50 watt/12V Mini underwater light without recess for spa or stairs with locking ring and gaskets 50 watt/12V	34,70€
2220115	Mini led reflektor bez niše, 18 jedinica led bela boja za spa kade ili stepenice poliester sa prstenom za zatezanje i dihtunzima 1,5 watt/12V Mini-LED underwater light without recess, 18 white led units for spa or stairs with locking ring and gaskets 1,5 watt/12V	37,80€
2220130	Sijalica 18 led belo 1,5 watt/12V Lamp with 18 white led 1,5 watt/12V	10,20 €
2220116	Minirefleksor a led bez niše, 18 jedinica led višebojni za spa kade ili stepenice poliester sa prstenom za zatezanje i dihtunzima 1,5 watt/12V Mini-LED underwater light without recess, 18 led multicolor for spa or stairs with locking ring and gaskets 1,5 watt/12V	37,80 €
2220131	Sijalica sa 18 led višebojnim-MR16 1,5 watt/12V Lamp with 18 multicolor led 1,5 watt/12V	10,30 €

RAZVODNA KUTIJA
DECK BOX

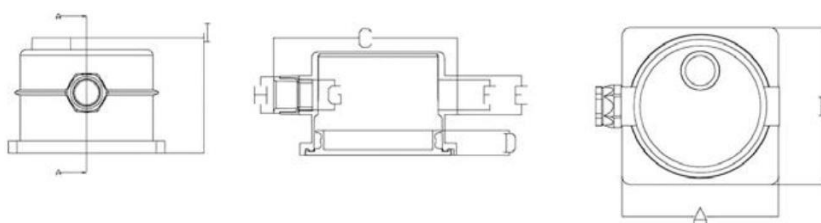

DIMENZIJE/ DIMENSIONS

A mm	B mm	C mm	D mm	E mm	F mm	G mm	H mm	I mm
129	129	151	20,20	32,20	24,40	24,40	29,70	94,50

Šifra /code	Opis/description	Cena/price
2220119	Razvodna kutija sa 3 konekcije 3/4" Deck box with 3 connections 3/4"	10,10 €

FLEKSIBILNE CEVI ZA REFLEKTOR
FLEXIBLE PIPE FOR UNDERWATER LIGHT



šifra/ code	opis /description	cena/ price
2220120	Fleksibilne cevi za reflektor- kom od 1 m - 3/4" sa navojem flexible tube for underwater light- 1 m to piece- threaded 3/4"	5,10 €

SKIMER SERIJE MT-14 U ABS ZA LAJNER / SKIMMER MT-14 IN ABS FOR LINER



cod.2220511



cod.2220512



cod.1070810



cod.1070811

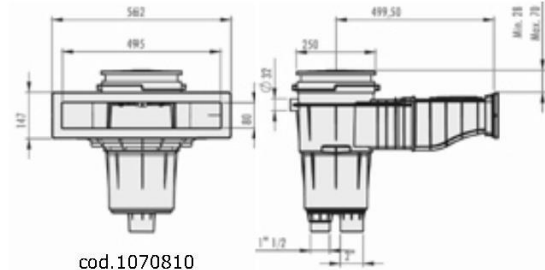

cod.1070810

ŠIFRA / code	Opis /description	Cena/price
2220511	Skimersa mesinganim umetcimai produženim vratom zaliner/Widemouthskimmerw/brassinertsand extension forliner	237,90 €
2220512	Skimmerširokog otvora sa umetcima i produžetkomza panele/tanke zidove/Widemouthskimmerw/ brass inserts and extension for panels/thin wa	165,70 €
1070810	Skimmer Senior prelivni u ABS / overflowskimmer Senior in ABS	231,60 €
2220518	Dihtung sandwich skimmer velikog otvora cod. 2220512 / sandwich seal for skimmer wide mouth	60,10 €
1070811	Dihtung sandwich za skimer senior / sandwich seal for skimmer senior	22,10 €

OPREMA ZA SKIMER SERIJE MT-14 / ACCESSORIES FOR SKIMMER MT-14



cod.2220515



cod.2220516



cod.2220517

Šifra /code	Opis /description	Cena/price
2220515	Prolunga skimmer skimmer throat extension	17,10 €
2220516	Prolunga coperchio skimmer 2220513 skimmer 2220513 cover extension	5,90 €
2220517	Prolunga coperchio skimmer	8,60 €

REGULATOR NIVOA, MLAZNICA NIVOA MT-14/LEVELREGULATOR,LEVELNOZZLEMT-14



Šifra/code	Opis/description	Cena/price
2220551	Regulator nivoa regulator	90,60 €

USISNA MLAZNICA SERIE MT-14 / VACUUM POINT MT-14



Šifra /code	Opis /description	Cena/price
2220505	Usisna zidna mlaznica na lepak ili navoj, sa mesinganim umetcima, za lajner Vacuum point to wall threaded or gluing, with brass inserts, for liner	32,60 €

BOCCHETTE DI IMMISSIONE SERIE MT-14 / RETURN FITTING MT-14



cod.2220502



cod.2220504

Codice / code	Descrizione /description	Prezzo/price
2220502	Bocchetta immissione a parete, con inserti in ottone, per liner Wall return fitting, with brass inserts, for liner	34,20 €
2220504	Bocchetta immissione a parete, per vetroresina Wall return fitting, for fiberglass	23,10 €

BOCCHETTE DA FONDO SERIE MT-14 / BOTTOM INLET MT-14



cod.2220503



cod.2220501

Codice / code	Descrizione /description	Prezzo/price
2220503	Bocchetta di fondo ad incollaggio ø50 Gluing bottom inlet ø50	55,50 €
2220501	Bocchetta a pavimento a incollaggio con griglia diam. interno 63, per liner Floor inlet glue with grid internal diam 63, liner	42,90 €

POZZETTI DI FONDO SERIE MT-14 / MAIN DRAIN MT-14



cod.1070033

Codice /code	Descrizione /description	Prezzo/price
1070033	Pozzetto di fondo con griglia ANTIVORTEX a norma UNI EN 13451-3 - per liner / Main drain ANTIVORTEX grating norm UNI EN 13451-3, for liner	52,60 €
1070081	Pozzetto di fondo ANTIVORTEX bianco C/ TUBO Ø50 / Main drain ANTIVORTEX white C/TUBO Ø50	90,00 €
1070082	Pozzetto di fondo ANTIVORTEX bianco C/ TUBO Ø62 / Main drain ANTIVORTEX white C/TUBO Ø62	106,50 €
1072276	Kit griglia per pozzetto di fondo ANTIVORTEX a norma UNI EN 13451-3 / Kit grating for antivortex main drain complied with UNI EN 13451-3	31,80 €

PROIETTORI SERIE MT-14 / UNDERWATER LIGHT MT-14



cod.2220533



cod.2220531



cod.2220536



cod.2220537



cod.2220519

Codice /code	Descrizione /description	Prezzo/price
2220531	Proiettore a led bianco, inserti in acciaio inox, per liner 14.5W / white led floodlight, stainless steel inserts, for liner 14.5W	356,70 €
2220532	Proiettore a led multicolore, inserti in ottone, per liner 22W/12V/ underwater light led multicolor w/brass inserts for liner 22W/12V	560,90 €
2220533	Proiettore a led multicolore piatto 22W/12V/ underwater light led multicolor flat 22W/12V	515,70 €
2220519	Guarnizione Sandwich per proiettore MT-14 / sandwich seal underwater light MT-14	20,80 €
2220534	Mini proiettore a led bianco, inserti in ottone, per liner 4W / mini underwater light led white w/brass inserts for liner 4W	450,60 €
2220536	Mini proiettore a led multicolore, inserti in ottone, per liner 4W/ mini underwater light led multicolor w/brass inserts for liner 4W	465,40 €
2220535	Mini proiettore a led bianco senza nicchia, per liner 4W / mini underwater light led white without recess for liner 4W	407,20 €
2220537	Mini proiettore a led multicolore senza nicchia, per liner 4W / mini underwater light led multicolor without recess for liner 4W	428,10 €
2220538	Telecomando per proiettori MT14 / remote control for MT14 underwater light	169,20 €
2220539	Scatola di comando per proiettori MT14 /receptor for MT14 underwater light	302,40 €

SKIMFILTRE



cod.2220600

SKIMFILTRE kombinuje jedan skimer velikog otvora sa jednim efikasnim ketridž filterom . Ovaj koncept olakšava ugradnju ne zahtevajući cevi između skimera i filtera, u jednom vrlo čvrstom sklopu. Model ELEGANCE 400 (otvor 400x200) ima ojačanu strukturu i može se koristiti kako ukopan tako instaliran i na filterski zid. Opremljen je sa dva ne perforirana prelivnika i jednom klapnom protiv buke.

SKIMFILTRE combine a wide mouth skimmer with a performing cartridge filter. This concept considerably simplifies installation not requiring pipe between skimmer and filter, with a very compact set. The ELEGANCE 400 model (hole 400x200) has a reinforced structure and can be used both underground and installed in a wall filter. Equipped with two not perforated overflows and of a fin with stopping noise.

Šifra / code	Opis / description	Cena / price
2220600	Skimfilitre Elegance 400 - kapaciteta max 20 m3/h-bazen paneli Skimfilitre Elegance 400 - max flow 20 m3/h - panels pool	1.113,00 €
2220601	Skimfilitre Classic 200 - kapaciteta max 11 m3/h-panelski bazen Skimfilitre Classic 200 - max flow 11 m3/h - panels pool	794,00 €
REZERVNI ULOŠCI / REPLACEMENT CARTRIDGES		
2220602	Uložak za zamenu Skimfilitre/Twinfilitre Elegance 400 Replacement cartridge for Skimfilitre/Twinfilitre Elegance 400	203,40 €
2220603	Uložak za zamenu Skimfilitre Classic 200 Replacement cartridge for Skimfilitre Classic 200	171,40 €

TWINFILTRE



TWINFILTRE model visokog kvaliteta sa velikim performansima, u prvom delu opremljen jednom predfilter kesom od 500 mikrona velikog kapaciteta za prikupljanje lisća i sitnog otpada. U drugom delu, filtrirajućim uloškom od 15 mikrona za optimalni kvalitet filtracije sa trajanjem servisa do jednog meseca pre čišćenja. Sa integrisanim indikatorom popunjenosti.

TWINFILTRE high-end model very performant, equipped in the first tank of a prefilter bag 500 micron great capacity to collect leaves and small debris. In the second tank filtering cartridge 15 micron for an optimal filtering quality with a service life of until a month before cleaning. Topping indicator integrat

Šifra / code	Opis / description	Cena / price
2220604	Twinfilitre Elegance 400 - kapacitet max 20 m3/h-panel bazeni paneli Twinfilitre Elegance 400 - max flow 20 m3/h - panels pool	1.681,20 €
KETRIDŽI ZA ZAMENU / REPLACEMENT CARTRIDGES		
2220602	Rezervni uložak Skimfilitre/Twinfilitre Elegance 400 Replacement cartridge for Skimfilitre/Twinfilitre Elegance 400	203,40 €

MLAZNICE / NOZZLES



cod.2220610



cod.2220611



cod.2220612

Šifra / code	Opis / description	Cena / price
2220610	Potisne mlaznice sa usmerivim mlazom 1 1/2 - bazen panelski Return fitting with orientable jet 1 1/2 - panels pool	24,40 €
2220611	Usisna mlaznica 1 1/2 - panel bazen Vacuum point 1 1/2 - panels pool	24,90 €
2220612	Rešetka za usisnu mlaznicu Vacuum point id	9,20 €

OPREMA SERIE W REFLEKTORI LED RAVNI/ FLAT UNDERWATER LED LIGHTS



Reflektor bez niše
Underwater lights without niche

Reflektor sa ili bez niše za postojeće bazene ili za obnovu bazena.
Reflektor raspolaže sa okruglom ili četvrtastom flanšom. Napajanje 12V AC.

*Projector with or without niche for existing pools or those who want to renew a pool.
Projector is series delivered with a round and a square frame. Power supply 12V AC.*



Reflektori sa nišom
Underwater lights with niche

Šifra / code	Opis /description	Cena/ price
2220630	Beli reflektor 12 led belo30W – bez niše Underwaterlight 12 white led 30W - without niche	366,50 €
2220631	Beli reflektor 12 led - RGB 28 W – bez niše Underwater light white 6 - RGB 28W-withoutniche	450,20 €
2220637	Reflektor 12 led beli - bazen paneli – sa nišom Underwater light 12 white led - panels pool - with niche	406,60 €
2220621	Reflektor 6 led beli - bazen liner – sa nišom Underwater light 6 white led - liner pool - with niche	371,20 €

REFLEKTOR EASYLED / UNDERWATER LED LIGHT EASYLED



Izvanredni dizajn i integracija: design EXTRA ravni. Odgovara raznim vrstama bazena. Lako se instalira: može se montirati na svim mlaznicama 1 1/2".

Design and seamless integration: design EXTRA flat. Suitable for different types of swimming pool. Easy to install: it can be mounted on all nozzles 1 1/2".

Šifra / code	Opis /description	Cena/ price
2220632	Beli reflektor 12 led belo(2600 lumen) 36W– za mlaznicu White 12-LED (2600 lumens) 36 watts - for return fitting	472,80 €
2220633	Beli reflektor 12 led - RGB (850 lumen) 28 W– za mlaznicu Color 12-LED(RGB)(850lumens)28watts-forreturnfitting	568,00 €

UNIVERZALNE SIJALICE BRZA MONTAŽA / UNIVERSAL LAMPS EASY TO INSTALL

Univerzalne SIJALICE DS BRZOM MONTAŽOM U POSTOJEĆOJ NIŠI - tip PAR 56

UNIVERSAL LAMP easy to install on existing niche - PAR 56 type



Šifra /code	Opis/description	Cena/ price
2220622	Sijalica 6 Led bela 19w-1500 lumen	181,90 Eur
2220623	Sijalica 12 Led bela 36w-2600 lumen	272,80 Eur
2220625	Sijalica 12 Led RGB 28W-850 Lumen	414,20 Eur

SET ZA DALJINSKU KONTROLU LINIJA WELTICO / REMOTE CONTROLS KIT WELTICO SERIES

Šifra /code	Opis /description	Cena/price
2220624	Set za daljinsku kontrolu ON/OFF za lampe led bela (centrala + daljinski) Remote ON/OFF control kit for led white lamps (control unit + remote control)	119,70 €
2220626	Set za daljinsku kontrolu za sijalicu LED RGB(centrala+daljinski) Remote control kit for led RGB lamps (control unit + remote control)	363,70 €

DONJI SLIVNIK / MAIN DRAIN

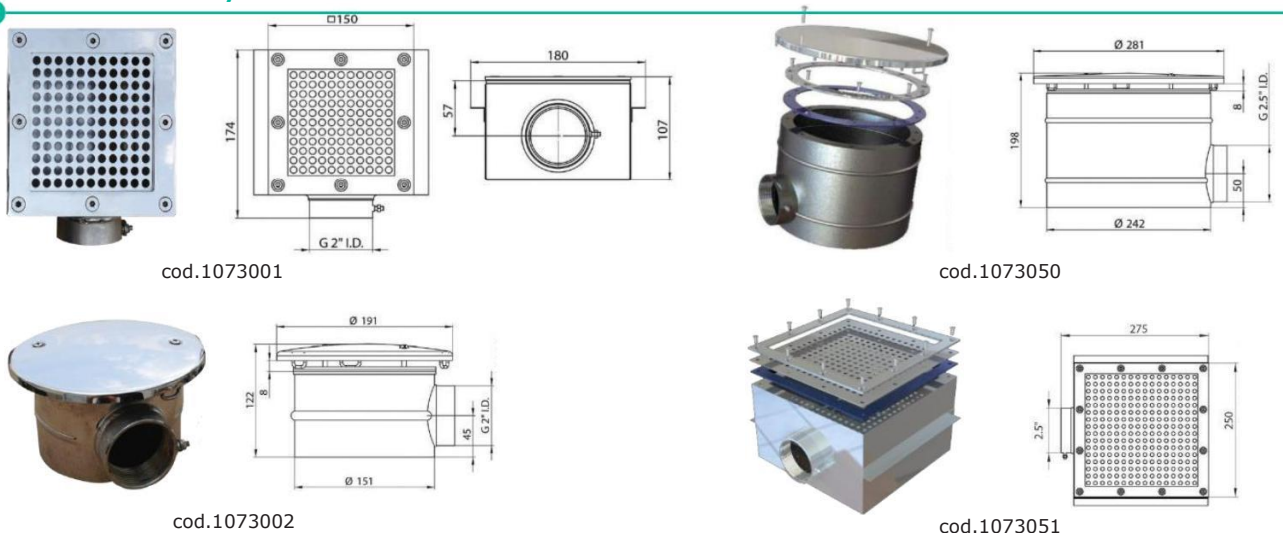

Šifra /code	Opis/description	Cena/price
1073001	Odvod na podu inox 316, 150x150 mm per liner 2" F, kapacitet 15m3/h Main drain 150x150 for liner 2" F, flow 15m3/h	283,50 €
1073002	Odvod na podu inox anti-vortice Ø 154 mm 2" F, kapacitet 15m3/h Main drain Ø 154 mm anti-vortex 2" F, flow 15m3/h	289,30 €
1073050	Odvod na podu inox anti-vortex Ø 240 mm, 2,1/2", kapacitet 30m3/h Main drain Ø 240 anti-vortex 2,1/2", flow 30m3/h	560,40 €
1073051	Odvod na podu 250x250mm per liner Ø 2" 1/2 inox 316, kapacitet 30m3/h Stainless steel 316 main drain 250x250mm for liner Ø 2" 1/2, flow 30 m3/h	725,50 €

MLAZNICE ČELIK INOX AISI 316 / STAINLESS STEEL AISI 316 RETURN FITTING



Šifra /code	Opis/description	Cena/price
1073003	Potisna zidna mlaznica 1,5" in inox 316 per liner / Wall return fitting 1,5" in inox 316 for liner	205,00 €
1073053	Adapter 1" x 1 1/2" inox 316 / Adapter 1" x 1 1/2 - stainless steel 316	175,60 €
1073054	Zidni prodor 1 1/2" inox 316 250mm per liner / Wall insert 1 1/2" 250 mm for liner - stainless steel 316	176,40 €
1073055	Zidni prodor 1 1/2" inox 316 250mm / Wall insert 1 1/2" 250 mm - stainless steel 316	121,00 €

USISNA MLAZNICA BLATA / VACUUM POINT

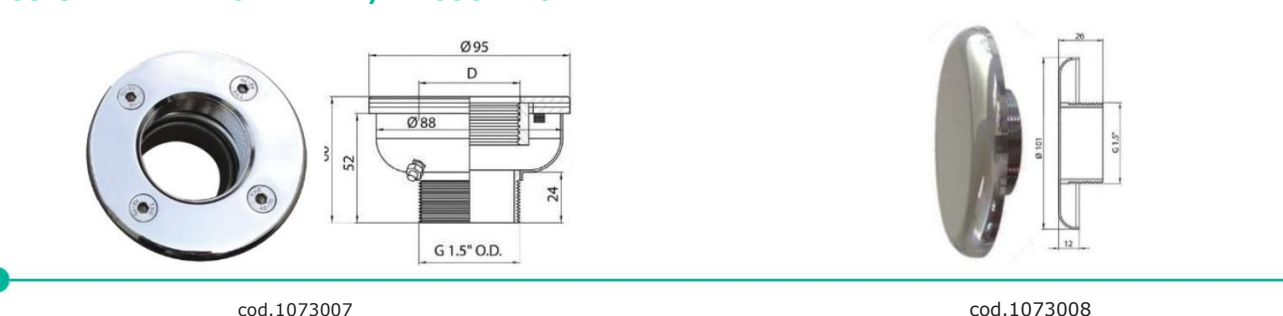

Šifra/code	Opis/description	Cena/price
1073007	Usisna mlaznica za blato inox per liner 1" 1/2 F / Vacuum point 1" 1/2 F	161,90 €
1073008	Poklopac mlaznice usis blata inox / Cap for vacuum point	108,00 €

BOCCHETTE IMMISSIONE A PAVIMENTO / FLOOR RETURN FITTING



Codice / code	Descrizione /description	Prezzo/price
1073004	Bocchetta immissione a pavimento Ø 1 1/2 in inox a portata variabile Floor return fitting Ø 1 1/2 in inox variable flow	202,00 €
1073030	Bocchetta di immissione con griglia a pavimento per liner, portata 9m3/h Flow floor inlet with grid for liner, max flow 9 m3/h	139,20 €
BOCCHETTE IMMISSIONE A PAVIMENTO CON AGGRAFFAGGIO RAPIDO / BOTTOM INLET WITH RAPID grafting		
1071043	Bocchetta immissione foratura 4mm portata 12m3/h, incastro INOX AISI316 e piattello in ABS Ø50-90 mm Bottom inlet holes 4mm, flow 12m3/h, stainless steel AISI316 rapid grafting and ABS top Ø50-90 mm	70,00 €
1071045	Bocchetta immissione, a pavimento inox AISI 316 per cemento armato Ø50-63 in stainless steel, for concrete	115,00 €
BOCCHETTA IMMISSIONE GEYSER A PAVIMENTO CON AGGRAFFAGGIO RAPIDO AISI 316 / BOTTOM INLET geysér WITH RAPID grafting aisi 316		
1071046	Bocchetta immissione a pavimento inox geysér in stainless steel geysér Ø50-63	133,90 €
FLANGIA/GRIGLIA INOX 316 PER BOCCHETTA E POZZETTO DI FONDO / flange, grid in stainless steel for return fitting and main drain		
1071029	Flangia/griglia inox per bocchetta C-319 for return fitting C-319	207,10 €
1071030	Flangia/griglia inox per pozzetto di fondo C-211 for main drain C-211	568,90 €
ASPIRAZIONI IDROMASSAGGIO / WATER SUCTIONS		
1071089	Aspirazione universale inox 316 Ø191mm - 2" portata 20m3/h Stainless steel 316 universal water suction Ø191mm - 2" flow 20m3/h	313,20 €

SKIMMER INOX

SKIMMER A BOCCA STRETTA / SMALL MOUTH SKIMMER

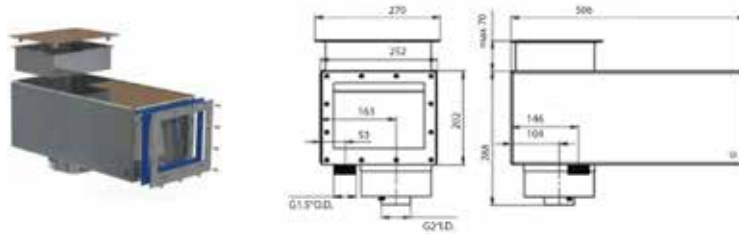

Codice / code	Descrizione /description	Prezzo/price
1073000	Skimmer lungo a bocca stretta per liner 2" F - INOX AISI 316 Long Skimmer with narrow mouth 2" F - AISI 316	1.514,00 €

SKIMMER SFIORO INOX / INOX OVERFOLW SKIMMER

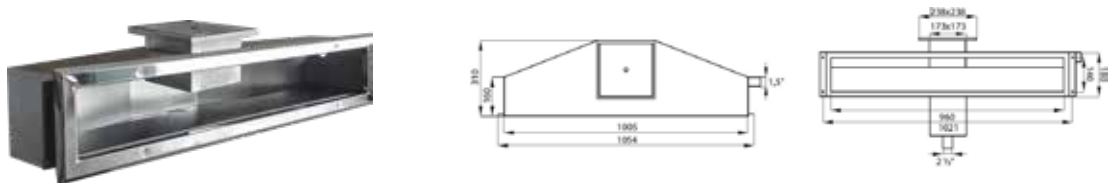

Codice / code	Descrizione /description	Prezzo/price
1073041	Skimmer sfioro inox, per liner - INOX AISI 316/ Inox overflow skimmer, for liner - AISI 316	2.844,20 €

PRELIVNI PRIGUŠIVAČ / OVERFLOW SILENCER

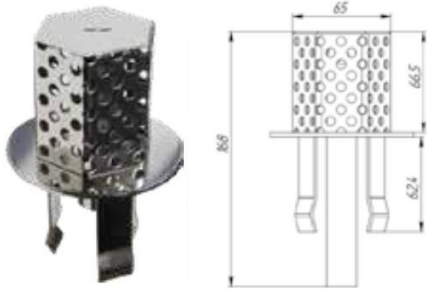

Šifra /code	Opis/description	Cena/price
1073052	Prigušivač za preliva za drenažu za cev Ø63, kapaciteta 8m ³ /h - inox 316L Overflow drainagesilencerfor Ø63mm pipe, flow 30m ³ /h - stainless steel 316L	311,90 €

REFLEKTORI INOX 316 / UNDERWATER LIGHTS INOX 316

REFLEKTOR LED INOX / LED STAINLESS STEEL LIGHT



Šifra /code	Opis/description	Cena/price
1073110	Reflektor inox 60 led bele boje 13,5W, perliner Underwater light inox 60 led white colour 13,5W liner	1.002,00 €
1073111	Reflektor inox 90 led RGB 16W sa daljinskim, za liner Underwater light inox 90 led RGB 16Ww/remote controller liner	1.119,00 €

MINIREFLEKTOR LED LORY POOL YA BAYEN, FIKSNA BOJA I RGB
MINI LED LIGHT LORY POOL, FIXED COLOR AND RGB

Aparat od mesinga i prstenasta čelična Inox matica AISI 316L sa 1 superLED da 1 W u 6 različitih tonaliteta: hladno bela, topla belo, zelena, plava, crvena i tamno žuta. Za instalaciju na bazenskim stepenicama (IP68-12 Vac/dc). Max dubina urona 2 m. Navojni zatvarač 1" 1/4, sa Inox šajbna mafi. 100mm. Standard kablo 2,80 m. Verzija RGB: 3 superLED da 1 W, funkcioniše samo sa odgovarajućim driver DDL 1/3. Montaža na prodoru.

Device in brass and inox steel AISI 316L with 1 SuperLED 1 W in 6 different colors: cold white, warm white, green, blue, red and amber. For installation on stairs pool (IP68 to 12 Vac/dc). Maximum diving depth 2 meters. Threaded fastener 1" 1/4, provided with steel Ø 100mm. Standard cable 2.80 m. RGB version: 3 SuperLEDs 1 W. Works only with a suitable driver DDL 1/3.

Šifra /code	Opis /description	Cena/price
1071078	Reflektor 3 led bela (topla ili hladna) (3 W) 12V dc/3 led white light*	341,50 €
1071080	Reflektor a 3 led RGB (3 W) 12V dc / 3 led light RGB	384,60 €
1070190	Driver DDL 1/3 fino sa 10 reflektora 3 led / driver DDL up to 10 light 3 led	1.128,60 €
1071106	Napajanje HK75/1375VA100-240V/12Vdc/power supply HK75/13	259,90 €

cod.1071079



cod.1071080

*Per il cod. 1071078 - Specificirati na kraju narudžbe željenu boju: bela, bela hladna, bela topla, zelena, plava, crvena, tamno žuta / Specify in the end of the order the desired color: white, cold white, warm white, blue, red, ambe

Šifra /code	Opis /description	Cena/price
1071079	Reflektor a 1 led (1W) 12V ac/dc bela hladna / 1 led light	
1071101	Reflektor a 1 led (1W) 12V ac/dc bela topla / 1 led light warm white	
1071102	Reflektor a 1 led (1W) 12V ac/dc zelena / 1 led light green	
1071103	Reflektor a 1 led (1W) 12V ac/dc plava / 1 led light blue	319,30 €
1071104	Reflektor a 1 led (1W) 12V ac/dc crvena / 1 led red	
1071105	Reflektor a 1 led (1W) 12V ac/dc tamno žuta / 1 led amber	

REFLEKTORI INOX

MINI REFLEKTOR LED LUKE ZA BAZEN, FIKSNA BOJA I RGB MINI LED LIGHT LUKE POOL, FIXED COLOR AND RGB



cod.1071081

Aparat od čelikainox AISI 316L sa 18 super LED da 1 W in 6 različiti tonalitetabela hladna, bela topla, zelena, plava, crvena i tamno žuta. Za instalacije u bazenima sa prodorom (IP68 - 20 Vdc). Maksimalna dubina urona 2 m. Fiksiranje sa spojnicom već isporučenom u konfekciji. Kablo standard 2,80 m. Koristiti samo podvodno i sa specifičnim napajanjem LK150/20. Versione RGB: 7 superLED da 3 W, funkcioniše sa namenskim driver DDL1/21. Montaža na prodoru. Svetlo difuzno - 120°

Light in stainless steel AISI 316L with 18 SuperLEDs 1 W in 6 different colors: cold white, warm white, green, blue, red and amber. For pool (IP68-20Vdc) with through wall flange. Maximum immersion depth of 2 meters. Mounting sleeve already provided in the package. Standard cable 2.80 m. Use only in diving, and with specific power LK150/20. Version RGB: 7 SuperLEDs 3 W, works with a suitable driver DDL1/21. Diffused light - 120°



cod.1071082

Šifra /code	Opis /description	Cena/price
1071081	Reflektora sa 18 led fiksna boja (18 W) 20V dc / 18 led light fixed color	735,00 €
1071082	Reflektor sa 7 led RGB 24 V dc / 7 led light RGB	963,80 €
1070191	Driver DDL 1/21 fino a 6 reflektora/ Driver DDL up to 6 light	1.128,60 €
1071086	Napajanje LK150/20150W-24Vdc fino a 8 reflektora power supply LK 150/20 to 8 light - 150 W -24Vdc	438,10 €

Navesti u fazi narudžbe željenu boju: bela, hladno bela, toplo bela, zelena, plava, crvena, tamno žuta. Specify in the end of the order the desired color: white, cold white, warm white, blue, red, amber

LED REFLEKTOR LUCY FLOOR PODNI LED FLOODLIGHT LUCY FLOOR - FLOOR



Aluminijumski aparat anticorodal u finišu standard eloksirano blistavo. Sa 9 superLED od 1 W. Za unutra i spolja (IP66) 12 V dc. Zaptivni ugradni prsten. Prolaznost i gazivost do 3,5 ton. Kablo standard 2,80 m.

Anticorodal aluminum device with standard satin gloss finish. With 9 SuperLEDs 1 W. For indoor and outdoor (IP66) 12 Vac / dc. Retaining ring to be collected. Driveway and walked up to 3.5 tons. Standard cable 2.80 m.

Šifra/code	Opis/description	Cena/price
1071077	Reflektor 9 led LUCY FLOOR aluminijum 9 led light LUCY FLOOR, aluminum	408,40

Navesti u fazi narudžbe željenu boju: belu, toplu belu, zelenu, plavu, crvenu, tamno žutu. Specify in the end of the order the desired color: white, warm white, blue, red, amber.

LED REFLEKTOR CRIS ZA TURSKO KUPATILO LED LIGHT TURKISH BATH



Mini reflektor sa 1 superLED da 1 W za postavljanje na stepenicama, zidovima, plafonima itd., idealan za turska kupatila. U 6 različitim tonalitetima: bela, toplo bela, zelena, plava, crvena i tamno žuta. Skrivena zidna ugradnja bez korišćenja šarafa za fiksiranje. Telo od aluminijuma i prekrivni čelični prsten Inox AISI 304. U funkciji isključivo preko uređaja za napajanje 350 mA dc 26700/E3, IP 66.

Small spot with 1 SuperLEDs 1 W to be applied on steps, walls, etc., ideal for steam baths. In 6 different colors: white, warm white, green, blue, red and amber. Wall-mounted retractable without the use of fixing screws. Aluminum body and cover ring in stainless steel AISI 304. Working only with an appropriate power supply 350 mA dc 26700/E3, IP 66.

Šifra /code	Opis/description	Cena/price
1071083	Reflektor 1 led CRIS / 1 led light CRIS	72,80 €

Navesti u fazi narudžbe željenu boju: belu, hladnu belu, toplu belu, zelenu, plavu, crvenu, tamno žutu. Specify in the end of the order the desired color: white, cold white, warm white, blue, red, amb

LAMPA LED GRETA – FIKSNA BOJA GRETA BULB - FIXED COLOR



Tri super LED 1 W boje hladno bele, toplo bele . rade direktno na 12 V zatvoreni su u kapsuli dimenzija obične halogene sijalice od 50 mm. Stvorena za zamenu dihroične sijalice u kojem bilo rasvetnom uređaju, bez ikakve intervencije na postojećem električnom uređaju. Spojnica GU5,3 -IP20.

Three SuperLEDs 1 W warm hite, cool white colors. Directly working at 12 V encapsulated in a container with the size of a common dichroic lamp of 50 mm. Born to replace the dichroic lamp in any lighting fixture, without any intervention on the existing electric -IP20.

Šifra /code	Opis /description	Cena/price
1070173	Sijalica sa 3 led 1 W GRETA - ugao15° Bulb with 3 led 1 w GRETA, angle 15°	80,20 €

U fazi narudžbe navesti željenu boju.
Specify in the end of the order the desired color.

NAPAJANJE POWER SUPPLY



cod.1070174-1071086



cod.1090395-1090396

Uređaj za napajanje 26700/E8 specifičan za rad LED na jednosmernoj struji (350 mA), IP 67. Povezuje do 8 reflektora led za tursko kupatilo CRIS. Povezivanje LED mora se uraditi isključivo serijski.

Uređaj za napajanje LK150/24 filtrirani u kutiji, za funkcionisanje LED na jednosmernoj struji 24 Vdc, IP 67. Povezuje do 8 reflektora led za bazen "LUKE".

Power26700/E8specificfortheoperationofLEDcurrent(350mA),IP67.Itconnectsup to 3 LED for turkish bath"CRIS". The connectionof the LEDs must beexecuted strictly in series.

Power LK150/24 is filtered in boxes, for the operation of LED current 24 Vdc, IP 67. Connects up to 8 LED projectors for swimming "LUKE "

Šifra /code	Opis/description	Cena/price
1070174	Uređaj za napajanje26700/E8finoa8proiettoriCRIS-350mAdc/ Power supply up to 8 lights	62,40 €
1071086	Uređaj za napajanjeLK150/20-150W-20Vdc/Powersupply	438,10 €
1090395	Dvostruko izolacioni transformator12Vac-100 VA/Trasform- er with double insulation 12 Vac - 100 VA	93,60€
1090396	Dvostruko izolacioni transformator12Vac-200 VA/Trasform- er with double insulation 12 Vac - 200 VA	108,00 €

DRIVER DDL PER RGB / DRIVER DDL FOR RGB



DriverDDL je glavna komandna jedinica, lake upotrebe, za sve svetiljke koje menjaju boju(RGB). To je l'interfejs sistemai omogućava da rasvetna tela koja su povezana na njega rade na sinhronizovan način. Upravljački programi i povezani izvori napajanja su smešteni unutra.

Radi direktno na 230 V i može kontrolisati više RGB farova.

The driver DDL is the main control unit, the use is simple, for all the change-color (RGB) light. It is the interface of the system and allows you to operate in a synchronized lighting connected to it. Inside it there are the drivers and their associated power supplies. Works directly at 230 V and can control multiple RGB lights.

Šifra/ code	Opis /description	Cena/price
1070190	Driver DDL 1/3 per LORY POOL RGB e YDRO POOL RGB do 10 reflektora Lory Pool and Ydro pool rgb DDL 1/3 driver, up to 10 lights	1.128,60 €
1070191	Driver DDL 1/21 per LUKE RGB do 6 reflektora Luke rgb DDL 1/21 driver, up to 10 lights	1.128,60 €

RIVALTA TOP

RIVALTA TOP **400** - PORTATA 6 M³/H
 RIVALTA TOP **500** - PORTATA 9 M³/H
 RIVALTA TOP **650** - PORTATA 16 M³/H
 RIVALTA TOP **700** - PORTATA 18 M³/H



RIVALTA SIDE

RIVALTA SIDE **450** - PORTATA 7,5 M³/H
 RIVALTA SIDE **500** - PORTATA 9 M³/H
 RIVALTA SIDE **600** - PORTATA 13,5 M³/H
 RIVALTA SIDE **650** - PORTATA 15 M³/H
 RIVALTA SIDE **760** - PORTATA 21 M³/H
 RIVALTA SIDE **900** - PORTATA 30 M³/H



PANAMA TOP - PANAMA SIDE SP

PANAMA TOP **400** - PORTATA 6 M³/H
 PANAMA TOP **500** - PORTATA 10 M³/H
 PANAMA TOP **650** - PORTATA 15 M³/H
 PANAMA SIDE SP **450** - PORTATA 8 M³/H
 PANAMA SIDE SP **500** - PORTATA 10 M³/H
 PANAMA SIDE SP **650** - PORTATA 15 M³/H



COLORADO

COLORADO **500** - PORTATA 7 M³/H
 COLORADO **600** - PORTATA 10 M³/H
 COLORADO **600** - PORTATA 12 M³/H
 COLORADO **750** - PORTATA 15 M³/H
 COLORADO **900** - PORTATA 22 M³/H
 COLORADO **900** - PORTATA 24 M³/H



MEDITERRANEO SIDE

MEDITERRANEO SIDE **450** - PORTATA 6 M³/H
 MEDITERRANEO SIDE **500** - PORTATA 9 M³/H
 MEDITERRANEO SIDE **650** - PORTATA 16 M³/H
 MEDITERRANEO SIDE **750** - PORTATA 20,5 M³/H
 MEDITERRANEO SIDE **900** - PORTATA 30 M³/H
 MEDITERRANEO SIDE **1000** - PORTATA 38 M³/H



MEDITERRANEO TOP

MEDITERRANEO TOP **400** - PORTATA 6 M³/H
 MEDITERRANEO TOP **500** - PORTATA 9 M³/H
 MEDITERRANEO TOP **650** - PORTATA 16 M³/H
 MEDITERRANEO TOP **750** - PORTATA 22 M³/H
 MEDITERRANEO TOP **900** - PORTATA 32 M³/H



TIRRENO

TIRRENO **500** - PORTATA 10 M³/H
 TIRRENO **630** - PORTATA 14 M³/H
 TIRRENO **710** - PORTATA 21 M³/H
 TIRRENO **900** - PORTATA 32 M³/H



MONOBLOCCO

GRUPPO FILTRO MONOBLOCCO

- HAVANA
- MEXICO
- ARGENTO



FILTRI

RIVALTA TOP / RIVALTA TOP

- Peščani filter od laminirane smole
- Poklopac u ABS sa zatvaranjem navrtkom
- Postolje od poliestera i fibreglasa visoke otpornosti.
- Opremljeni sa: manometrom, odvodom vode, ručnim ventilacionim otvorom
- Max radnim pritiskom : 2,5 kg/cm²
- Resinlaminated sand filters
- ABS cover with locking nuts
- Base in polyester and glass fiber with high density.
- Equipped with: pressure gauge, bleed water, manual air vent.
- Maxi service pressure: 2,5 kg/cm²

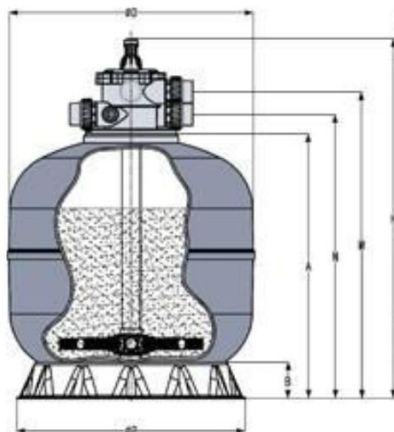

DIMENZIJE / DIMENSIONS

Mod. Ø mm	A mm	H mm	M mm	N mm	B mm	ØP mm
400	500	750	609	550	75	390
500	610	860	719	660	75	390
650	690	940	799	740	95	565
700	750	1000	859	800	95	565

Šifra / code	Opis / description	Ø mm	Spojevi in / out mm	Protok m ³ /h	Pesak Kg	Cena / price
1080059	Filter Rivalta top 400 / filter top 400	400	50 (1"½)	6	30	427,10 €
1080061	Filter Rivalta top 500 / filter top 500	500	50 (1"½)	9	80	480,00 €
1080063	Filter Rivalta top 650 / filter top 650	650	50 (1"½)	16	135	606,10 €
1080064	Filter Rivalta top 700 / filter top 700	700	50 (1"½)	18	215	704,20 €

RIVALTASIDE / RIVALTASIDE

- Peščani filteri od laminirane smole
- Urađeni od laminirane smole i pleksiglasa koji mudaju izvanredni briljantni finiš
- Sa flanšom i šrafovim. Postolje od poliestera i pleksiglasa visoke otpornosti.
- Opremljeni kolektorom i difuzorom nepromenljivog PVC.
- Opremljeni manometrom, odvodom vode i ručnim ventilacionim otvorom
- Maxi radni pritisak: 2,5 kg/cm²
- Sand filters resinlaminated
- Made of resin and fiberglass laminate that give excellent high gloss finish
- Transparent cover with flange bolts. Base polyester and glass fiber densities
- Equipped with a manifold and a durable PVC diffuser
- Equipped with a pressure gauge, a drain of water manual and manual air vent
- Pressure maxi service: 2,5 kg / cm²

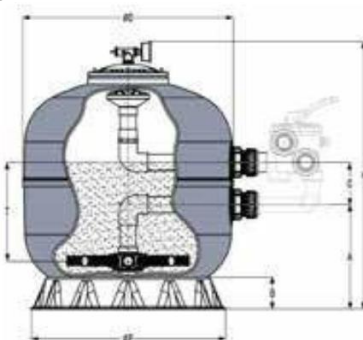

DIMENZIJE / DIMENSIONS

Mod. ØD mm	A mm	C mm	H mm	T mm	B mm	ØP mm
450	260	125	640	250	75	390
500	280	125	710	280	75	390
600	310	125	785	300	95	565
650	310	125	785	300	95	565
760	380	220	980	410	95	565
900	430	220	1100	480	150	790

Šifra / code	Opis / description	Ø mm	Spojevi in / out mm	Protok m ³ /h	Pesak Kg	Cena / price
1080072	Filter Rivalta side 450 / filter side 450	450	50 (1"½)	7,5	55	532,90 €
1080066	Filter Rivalta side 500 / filter side 500	500	50 (1"½)	9	80	550,00 €
1080067	Filter Rivalta side 600 / filter side 600	600	50 (1"½)	13,5	120	622,40 €
1080068	Filter Rivalta side 650 / filter side 650	650	50 (1"½)	15	135	671,20 €
1080073	Filter Rivalta side 760 / filter side 760	760	63 (2")	21	260	956,00 €
1080070	Filter Rivalta side 900 / filter side 900	900	63 (2")	30	425	1.176,00 €

*Navedene mere da se smatraju kao nominalne dimenzije / * The measurements are to be considered as nominally

** Protok je dat kao indikativan, pošto zavise od gubitaka pritiska instalacije i krivine priključka pumpe

** The course dates are an indication, since they depend on the pressure drop and the curvature of the pump installation.

MEDITERRANEO SIDE FILTER

- Motani filtri, unutrašnja obloga od poliestera i fiberglasa.
- Realizovani korišćenjem najmodernijih tehnika izrade obezbeđujući tako maksimalni kvalitet, otpornost i veći rok trajanja.
- 6 položajni ventil, ergonomska linija
- Izvanredne funkcionalne performanse
- Staklena čaša za proveru filtrirane vode i manometar za proveru pritiska.
- Radni pritisak: 2.5 kg/cm²
- Lako se čiste
- Prilagodljivi automatskom čišćenju
- Spojevi na lepljenje
- Poklopac na šrafove do mod. 900
- Poklopac sa navojnim zatvaranjem za model 1000.
- Coil filters with internal coating of polyester and fiber glass
- Manufactured using the most modern construction techniques, ensuring high quality, resistance and greater durability
- 6-ways valve, ergonomic design
- Good operating performance
- Glass to inspect the filtered water and a pressure gauge to check pressure.
- Working pressure: 2.5 kg/cm²
- Easy to clean
- Suitable for the use of automatic cleaner robot
- Fittings for bonding
- Cover with bolts for the mod. up to 900
- Lid with threaded for mod 1000

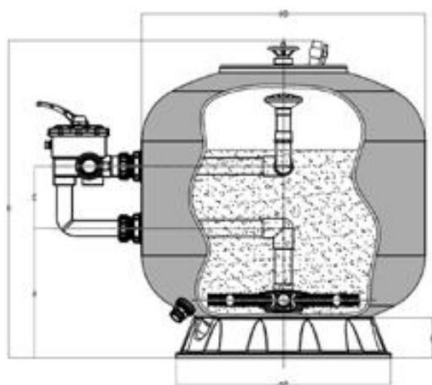
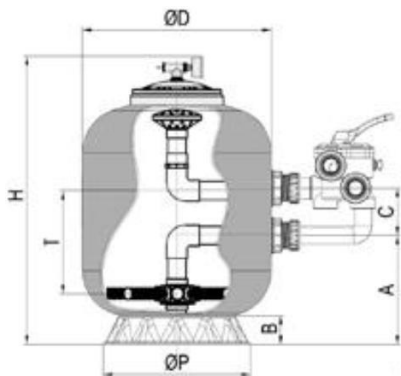

DIMENZIJE/DIMENSIONS

Model	D mm	H mm	A mm	B mm	C mm	P mm	T mm	Pesak 0,4/0,7 kg
450	450	640	260	75	125	390	250	56
500	500	680	280	75	125	390	280	90
650	650	750	310	95	125	565	300	170
750	750	940	385	95	220	565	410	300
900	900	1070	430	150	220	790	480	450

DIMENZIJE/DIMENSIONS

Model	D mm	H mm	A mm	C mm	B mm	P mm	T mm	Pesak 0,4/0,7 kg
1000	1000	1190	460	220	150	790	550	710

Šifra / code	Opis/description	Spojevi in/ out mm	Ventil selekc. inc	Protok m3/h	Težina Kg	Cena/price
1080270	Filter Mediterraneo Side 450 / filter side 450	50 (1"½)	1"1/2	6	17,6	484,10 €
1080271	Filter Mediterraneo Side 500 / filter side 500	50 (1"½)	1"1/2	9	19,6	500,40 €
1080272	Filter Mediterraneo Side 650 / filter side 650	50 (1"½)	1"1/2	16	27,6	622,40 €
1080273	Filter Mediterraneo Side 750 / filter side 750	63 (2")	2"	20,5	45	992,60 €
1080274	Filter Mediterraneo Side 900 / filter side 900	63 (2")	2"	30	53,8	1.139,00 €
1080275	Filter Mediterraneo Side 1000 / filter side 1000	63 (2")	2"	38	67,8	1.570,00 €

*Le misure riportate sono da considerarsi quali dimensioni nominali
 * The measurements are to be considered as nominally

MEDITERRANEO TOP

- Motani filteri, unutrašnja obloga od poliestera i fibreglasa.
- Realizovani korišćenem najsavremenije tehnike izrade obezbeđujući tako visoki kvalitet, otpornost i duži rok trajanja.
- Telo od fibreglasa tretirano protiv UV
- Šesto položajni ventil, ergonomski dizajn
- Odlične funkcionalne performanse
- Otporan na hemijske proizvode i na koroziju.
- Staklena čaša za proveru filtrirane vode i manometar za proveru pritiska.
- Čep za odvod vode.
- Radni pritisak: 2.5 kg/cm²
- Coil filters with internal coating of polyester and fiber glass
- Manufactured using the most modern construction techniques, ensuring high quality, resistance and greater durability
- Body in treated fiberglass against UV
- 6-ways valve, ergonomic design
- Good operating performance
- Resistant to chemicals and corrosion
- Glass to inspect the filtered water and a pressure gauge to check pressure.
- Drain plug
- Working pressure: 2.5 kg/cm²

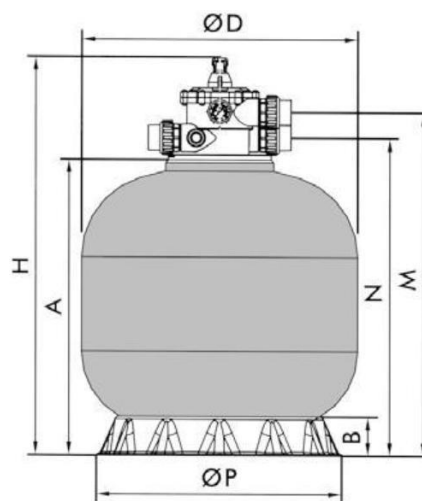

IMPIANTO/EQUIPMENT

DIMENZIJE / DIMENSIONS

Model	Ø D mm	H mm	B mm	A mm	N mm	M mm	Pesak 0,4/0,7 kg
400	400	720	75	482	535	594	25
500	500	830	75	592	645	704	59
650	650	950	95	712	765	824	119
750	750	1120	95	820	882	962	230
900	900	1270	150	970	1032	1112	400

Šifra /code	Opis /description	Spojevi in/out mm	Brzina filtracije m/h	Protok m ³ /h	Težina Kg	Cena/price
1080220	Filter Mediterraneo Top 400 / filter top 400	50 (1 1/2")	50	6	13	370,20 €
1080221	Filter Mediterraneo Top 500 / filter top 500	50 (1 1/2")	50	9	18	447,50 €
1080222	Filter Mediterraneo Top 650 / filter top 650	50 (1 1/2")	50	16	23	524,80 €
1080276	Filter Mediterraneo Top 750 / filter top 750	63 (2")	50	22	-	805,50 €
1080277	Filter Mediterraneo Top 900 / filter top 900	63 (2")	50	32	-	956,00 €

PANAMA TOP / PANAMA TOP

- Max korisni pritisak 2 Bar
- Unutrašnje cevi od Ø 50 mm
- Šestopoložajni ventil sa manometrom
- Telo od polietilena
- Ventil za brz ispust

- maximum use of 2 Bar
- pipe internal from Ø 50 mm
- 6-way valve with gauge
- body made of polyethylene
- quick exhaust valve

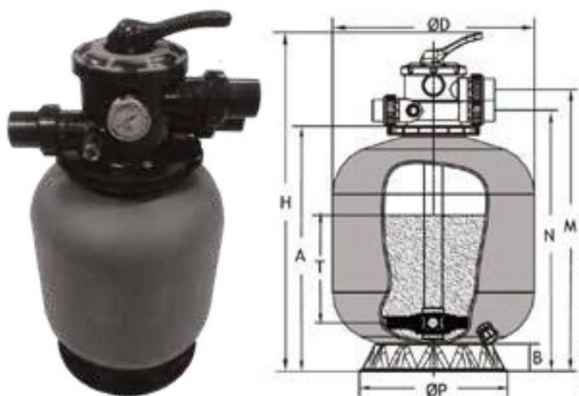

DIMENZIJE / DIMENSIONS

Model	Ø D mm	H mm	A mm	B mm	M mm	N mm	Ø P mm	T mm
400	400	765	503	73	609	554	320	160
500	533	870	600	75	709	654	390	260
650	635	965	700	95	809	754	565	370

Šifra / code	Opis /description	Ø mm	Spojevi in/ out mm	Protok m3/h	Pesak Kg	Cena/price
1080350	Filter Panama top 400 / filter top 400	400	50 (1"½)	6	35	264,80 €
1080351	Filter Panama top 500 / filter top 500	533	50 (1"½)	10	85	354,50 €
1080352	Filter Panama top 650 / filter top 650	635	50 (1"½)	15	145	414,30 €

PANAMASIDESP / PANAMASIDESP



- Max korisni pritisak 2 Bar
- Unutrašnje cevi od Ø 50 mm
- Šestopoložajni ventil sa manometrom
- Telo od polietilena/Ventil za brzi ispust
- Maximum use of 2 Bar
- pipe internal from Ø 50 mm
- 6-way valve with gauge
- body made of polyethylene
- quick exhaust valve

DIMENZIJE / DIMENSIONS

Model	Ø D mm	H mm	A mm	B mm	C mm	G mm	Ø P mm	T mm
450	450	665	260	75	125	90	390	250
500	533	712	280	75	125	90	390	280
650	635	810	310	95	125	90	565	300

Šifra / code	Opis /description	Ø mm	Spojevi in/ out mm	Protok m3/h	Pesak Kg	CENA/price
1080355	Filter Panama side 450 / filter side 450	450	50 (1"½)	8	45	337,40 €
1080353	Filter Panama side 500 / filter side 500	533	50 (1"½)	10	85	397,20 €
1080354	Filter Panama side 650 / filter side 650	635	50 (1"½)	15	145	469,90 €

FILTRI

TIRRENO



- Peščani motani filteri za domaće bazene.
- Telo filtera urađeno u ABS i ojačano namotavanjem s polja u fibreglasu..
- Poklopac filtera se šrafi šrafovim.
- Kompletiran sa manometrom, odušak vazduha i višepoložajni ventili.
- Max radni pritisak 2,5 kg / cm².
- Bobbin wound sand filters for domestic pools
- Filter shell made of ABS plastic and reinforced by fiberglass bobbin winding outside.
- Filter lid with bolts.
- Complete with pressure gauge, air purge and multi ways valve.
- Max operation pressure 2,5 kg/cm².



Višesmerni ventil
Multiway valve



Poklopac filtera u ABS
ABS filter lid



Kraci kolektora u ABS
ABS collector arms



Drenaža filtera
Filter drainage



Konični distributer
Conical distributor



Model	D mm	H ₁ mm	H ₂ mm	H ₃ mm	H mm	W mm	Pesak 0,4/0,7 kg
-------	------	-------------------	-------------------	-------------------	------	------	------------------

DIMENZIJE

DIMENSIONI / DIMENSIONS

500	500	750	700	305	455	260	100
630	630	830	760	335	485	260	150
710	710	890	855	355	515	295	250
900	900	1000	960	395	570	295	450

Šifra /code	Opis /description	Spojevi in/out mm	Ventil selekt. inc	Protok m ³ /h	Težina Kg	Cena/price
1080612	Peščani filter Tirreno 500 Tirreno 500 sand filter	50	1"1/2	10	10,2	577,10 €
1080613	Peščani filter Tirreno 630 Tirreno630sandfilter	50	1"1/2	16	20	712,20 €
1080614	Peščani filter Tirreno 710 Tirreno710sandfilter	50	1"1/2	21	32	999,00 €
1080615	Peščani filter Tirreno 900 Tirreno900sandfilter	50	1"1/2	32	47	1.280,00 €



- Coperchio trasparente Ø400 mm
 - Manometro
 - Viti e rondelle in acciaio inox VA4 (316)
 - Dadi antigrippaggio in ottone nichelato
 - Scarico sabbia grande da 2"1/2 e scarico acqua da 1"1/4
 - Sistema di ripresa a bracci
 - Diffusore superiore a smontaggio rapido per facilitare le operazioni di manutenzione
 - Pressione di prova 3,75 bar
 - Conforme a EN 16713 e UNI 10637:2024
 - Garanzia 5 anni sul corpo filtro
- Transparent cover Ø400 mm
 - Pressure gauge
 - VA4 (316) stainless steel screws and washers
 - Nickel-plated brass anti-seize nuts
 - Large sand drain 2"1/2 and water drain 1"1/4
 - Arm intake system
 - Quick disassembly top diffuser for easy maintenance operations
 - Test pressure 3.75 bar
 - Complies with EN 16713 and UNI 10637:2024
 - 5-year warranty on filter tank

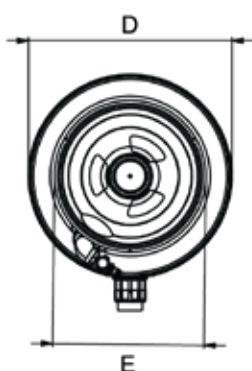
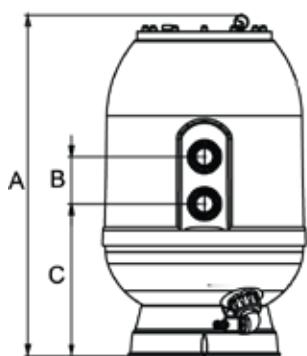

DIMENSIONI / DIMENSIONS

Modello	A mm	B mm	C mm	D mm	E mm	F mm
500	946	125	450	520	450	90
600	1010	125	530	620	450	90
600	1010	140	485	620	450	100
750	1115	140	565	770	720	100
900	1150	140	585	930	720	100
900	1150	270	515	930	720	110

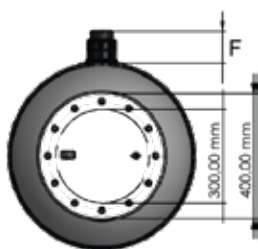

Attacchi robusti e di grandi dimensioni in ABS nero
Large robust unions in black ABS



Coperchio trasparente ad alta resistenza meccanica e chimica
Cover in transparent for high mechanical & chemical resistance



Scarico tra i più grandi del mercato
Largest drain on the market

Codice / code	Descrizione / description	Ø nom. mm	Attacchi in/out mm	Valvola selettiva inc	Portata m³/h [Vel. 35 m/h]	Portata m³/h [Vel. 50 m/h]	Altezza letto filtrante mm	Superficie filtrante m²	Sabbia Kg	Peso Kg
1080519	Filtro Colorado 500	500	50	1"1/2	7	10	600	0,20	150	27
1080520	Filtro Colorado 600	600	50	1"1/2	10	14	600	0,28	220	30
1080521	Filtro Colorado 600	600	63	2"	12	16	600	0,28	220	33
1080522	Filtro Colorado 750	750	63	2"	15	22	600	0,44	345	40
1080523	Filtro Colorado 900	900	63	2"	22	32	600	0,64	500	50
1080524	Filtro Colorado 900	900	75	2"1/2	24	34	600	0,64	500	55

GRUPA MONOBLOK FILTERA HAVANA / SAND FILTER SYSTEM HAVANA



Cod. 8050113 - 8050114

SASTAV GRUPE:

- Monoblok filter (bez peska, vreće od 25 kg)
- Sistem osmišljen za brzo montiranje i postr ojavanje komponenti
- Cevi za povezivanje pumpe
- 6 položajni ventil za garantovanje max protoka i pod niskim pritiskom (cod. 8050113-8050114)

COMPOSITION OF THE GROUP:

- Sand filter (excluded sand, bag of 25 kg).
- System designed for quick assembly and precise alignment of components
- Pipe connecting pump and filter with threaded couplings
- 6-ways valve provides maximum flow at low pressure drop (8050113-8050114)

Šifra /code	Opis/description	Ø mm	Sabbia Kg	Portata m ³ /h	Pompa CV	Cena/price
8050113	Monoblocco HAVANA 500 Sand filter system with pump 500	500	60	8	0,6	660,00 €
8050114	Monoblocco HAVANA 650 Sand filter system with pump 650	650	160	15	1	945,70 €

FILTER MONOBLOK GRUPA MEXICO SAND FILTER SYSTEM MEXICO



Cod.8050053-8050050



Cod. 8050051

- Monoblok filter (bez peska, vreće od 25 kg)
- Telo pumpe od polietilena velike gustine otporno na 2 bar
- Baza podloge u ABS
- Cevi za povezivanje pumpe/ filter sa spojnicama sa navojem
- *Filter block (non including sand, bag of 25 kg).*
- *Filter body in high-density polyethylene resistant to 2 bar*
- *ABS support base*
- *Pipe connecting pump and filter with threaded couplings*

Šifra /code	Model/model	Ø mm	Sabbia Kg	Protok m ³ /h	Pumpa CV	cena/price
8050050	Monoblok Mexico 300 / Sand filter system with pump 300	300	20	7	0,33	290,40 €
8050051	Monoblok Mexico 400 / Sand filter system with pump 400	400	35	8,5	0,5	384,90 €
8050052	Monoblok Mexico 500 / Sand filter system with pump 500	500	75	10	0,75	438,20 €
8050053	Monoblok Mexico 600 / Sand filter system with pump 600	600	140	22	1,5	669,00 €

FILTER MONOBLOK GRUPA ARGENTO SAND FILTER SYSTEM ARGENTO



SASTAV GRUPE:

- Monoblok filter (bez peska, vreće od 25 kg)
- Telo filtera od pleksiglasa
- Max korisni pritisak 2 Bar
- Baza podloge u ABS.
- Cevi za povezivanje pumpe
- Filter sa spojnicama sa navojem
- Sand filter (sand not included, bags of 25 kg)
- Filter body in fiberglass
- Maximum use of 2 Bar
- ABS support base.
- Pipe connecting pump
- Filter with threaded couplings

Šifra /code	Opis /description	Ø mm	Pesak Kg	Pumpa CV	Cena/price
8050170	Monoblok Argento 400 - pumpa 6,5 m ³ /h - Sand filter system 400 with pump 6,5 m ³ /h	400	50	0,5	650,90 €
8050171	Monoblok Argento 500 - pumpa 10 m ³ /h - Sand filter system 500 with pump 10 m ³ /h	500	100	0,75	785,10 €

VENTILI I MANOMETRI / VALVES AND GAUGES



6 položajni ventil - filteri mediterraneo Side
valves 6 ways for mediterranean Side
cod.1080205



6 položajni ventil - filteri mediterraneo Top
valves 6 ways for mediterranean Top
cod. 1080207



6 položajni ventil - filteri rivalta
valves 6 ways for rivalta



6 položajni ventil - filteri monoblok
valves 6 ways for monoblock
cod. 1080356



navojni ventili
threaded valves

Šifra/ code	Opis /description	Cena/price
6 položajni ventili za peščane filtere kompatibilni sa filterom: VALVES 6 ways for sand filter compatible with: MEDITERRA-NEO, RIVALTA (dal 2017), PANAMA, POLARIS, BLU HBS		
1080205	Ventil SIDE 1" ½ / valve side 1" ½	134,20 €
1080206	Ventil SIDE 2" / valve side 2"	179,00 €
1080208	Ventil SIDE 2" ½ / valve side 2" ½	552,50 €
1080207	Ventil TOP 1"½ per Mediterraneo/Rivalta /valve top 1"½ for Mediterraneo/Rivalta	134,20 €
1080203	Ventil TOP 2" per Mediterraneo / valve top 2" for Mediterraneo	176,00 €
1080356	Ventil TOP 1"½ per Panama / valve top 1"½ for Panama	112,00 €
6 položajni VENTILI za filtere RIVALTA (ante 2017) / VALVES 6 ways for RIVALTA (before 2017)		
1080219	Ventil TOP 1" ½ / valve top 1" ½	103,70 €
1080209	Ventil SIDE 1" ½ / valve side 1" ½	122,10 €
1080210	Ventil SIDE 2" / valve side 2"	189,10 €
1080204	Ventil SIDE 2" ½ filteri Verduno e Blu Hbs 1000 / Valve SIDE 2" ½ filters Verduno and Blue Hbs 1000	337,60 €
1080208	Ventil SIDE 2" ½ / valve side 2" ½	€ 483,30
6 položajni VENTILI za filtere TIRRENO / VALVES 6 ways for TIRRENO		
1080608	Ventil TIRRENO 1" ½ / valve tirreno 1" ½	93,90 €
1080609	Ventil TIRRENO 2" / valve tirreno 2"	145,40 €
VENTILI za monoblok HAVANA i ARGENTO/ filteri HAVANA / VALVES for HAVANA e ARGENTO monoblocks / filters HAVANA		
600-13702	Ventil 4 položajni monoblok Havana / valve 4 ways monoblock Havana	83,90 €
600-13703	Ventil 6 položajni monoblok Havana / valve 6 ways monoblock Havana	100,60 €
1080356	Ventil 6 položajni monoblok Argento / valve 6 ways monoblock Argento	€ 150,30
NAVOJNI VENTILI / threaded VALVES		
1080411	Ventil SM 10 – priključci sa navojem 1"½ / valve SM 10 -1"½	93,30 €
1080412	Ventil SM 20 – Priključci sa navojem 2" / valve SM 20 -2"	146,70 €
1080213	Ventil SM 30-AO na lepljenje / bonding valve SM 30 -AO	1.062,00 €



MANOMETAR / MANOMETER

1080216	Manometar 0-2,5 bars, 1/8" / Manometer 0-2,5 bars, 1/8"	20,70 €
600-00791	Manometar za filtere Mediterraneo / Manometer for Mediterraneo filters	23,80 €

AKTIVATOR 6 POLOŽAJNOG VENTILA / 6-WAY VALVE ACTUATOR



Šifra /code	Opis /description	cena/price
1080414	Aktivator 6 položajnog ventila 1" ½ o 2" / 6-way valve actuator	1.662,50 €
OPREMA / ACCESORIES		
1041371	Kuglasti elektroventil Ø50 2 vie 24 V ac/dc / 2-way solenoid ball valves	1.438,00 €
1041372	Kuglasti elektroventil Ø63 2 vie 24 V ac/dc / 2-way solenoid ball valves	1.467,00 €

FILTRI SA ULOŠKOM / CARTRIDGE FILTERS



KFC

MOD. KFC

Lako čišćenje cevi i ekstra kapacitet zadržavanja prljavštine. Poklopac sa prstenom za blokiranje sa ručkama za lako i sigurno skidanje. Telo od ABS termoplastike, priključak 63 mm na lepljenje.

Clean easy plumbing and extra dirt holding capacity. Lid lock-ring handle makes removing the lid easy and safe. Body in ABS thermoplastic, connection 63 mm gluing.

MOD. GL

GL100: Štampani inekcioni filter u jednom komadu, sa prstenom za blokiranje, za laku instalaciju. Otporan na hemijske i klimatske agense. Rezervoar od Polipropilena ojačanog sa fiberglassom za otpornost i dugo trajanje. Sa internim uloškom.

GL100: One-piece injection molded filter with locking ring for easy installation. Resistant to chemical and climatic agents. Fiberglass-reinforced polypropylene reservoir for strength and long life. One cartridge inside.

GL 240/420: Kombinuje osobine filtera visokog pojašasa. Sa malim održavanjem. Sa dizajnom od 4 uloška, nudi maksimalnu filtrirajuću površinu kako bi obuhvatio što veću prljavštinu i produžio vremenski razmak između čišćenja. Sa četiri unutrašnja uložka.

GL 240/420: Combines high-end filter performance with low maintenance. With its four-cartridge design, it offers maximum filter surface area to capture more dirt and extend the time between cleanings. Four cartridges inside.



GL

Šifra/code	Filter sa uloškom /Cartridge filter	Protok m3/h	Priključak in/out	Visina mm	Pritisak max rada	Cena/price
1080144	Mod. KFC 50	11,4	63/63	548	2,5 bar	276,60 €
1080147	Mod. KFC 75	65,1	63/63	728	2,5 bar	325,40 €
1080148	Mod. KFC 100	85,4	63/63	908	2,5 bar	378,30 €
1080149	Mod. KFC 150	101,7	63/63	1088	2,5 bar	427,10 €
1090146	Mod. GL 100	11,4	50/50	962	3 bar	355,20 €
1090147	Mod. GL 240	27,3	63/63	862	3 bar	818,40 €
1090148	Mod. GL 420	32,0	63/63	1169	3 bar	980,80 €

Šifra /code	Opis /description	Cena/price
REZERVNI ULOŠCI / REPLACEMENT CARTRIDGES		
1080153	Uložak KFC 50 / Cartridges	65,10 €
1080152	Uložak KFC 75 / Cartridges	85,40 €
1080155	Uložak KFC 100 / Cartridges	101,70 €
1080156	Uložak KFC 150 / Cartridges	122,00 €
1090149	Uložak GL 100 / Cartridges	90,30 €
1090150	Uložak GL 240 / Cartridges	45,40 €
1090151	Uložak GL 420 / Cartridges	83,20 €

REZERVNI ULOŠCI / REPLACEMENT CARTRIDGES



Šifra/code	Opis/description	Visina mm	Ø spolja mm	Ø izn. mm	cena/price
KOMPATIBILNI ULOŠCI HAYWARD / CARTRIDGES COMPATIBLE WITH HAYWARD					
1080162	Uložak Hayward C 250 - rif.C-7626	250	175	75	160,50 €
1080163	Uložak Hayward C 500 - rif.C-7656	500	178	75	232,30 €
KOMPATIBILNI ULOŠCI STA-RITE / CARTRIDGES COMPATIBLE WITH STA-RITE					
1080171	Uložak Sta-rite 50 GPM - rif.UHD-SR50	339	220	104	315,00 €
1080172	Uložak Sta-rite 70 GPM - rif.UHD-SR70	463	220	104	352,60 €
1080173	Uložak Sta-rite 100 GPM - rif.UHD-SR100	654	220	104	450,60 €
1080174	Uložak Sta-rite 135 GPM/PF135- rif.UHD-R135	873	220	102	676,20 €
1080175	Uložak Sta-rite 137 GPM/PTM135 - rif.UHD-SR137	800	220	100	661,50 €
KOMPATIBILNI ULOŠCI HARMSCO / SUBAPAC / COMPATIBLE WITH HARMSCO/ SUBAPAC					
1080176	Uložak HARMSCO T-380	246	69	28	39,20 €

OBRA TI PAŽNJU: Neki ulošci su kompatibilni sa drugim modelima, imati u vidu dimenzije, prečnike i visine tabele da bi odredili model. Kompatibilni ulošci HAYWARD, MARTEC, STARITE isporučuju se sa zaptivkom poklopca i lubrikantom. Naznačene mere trebaju se smatrati nominalnim dimenzijama.
 NOTE: Some cartridges are compatible with other models, refer to sizes, diameters and heights of the table to determine the model. The compatible cartridges Hayward, Martec, Starite are delivered with the cover gasket and the lubricant. Measurements are to be considered as nominally

Šifra /code	Opis /description	Cena/price
1055124	Češalj četka za čišćenje uložka.	24,60 €

**DŽAKOVI PESKA I DIATOMEA
BAGS OF SAND AND DIATOMS**

Šifra /code	Opis /description	Džak	Cena/price
SABBIA / SAND			
1080230	Kvarcni pesak 0.4/0.8 / sand quartz 0.4/0.7	Po džaku od 25 Kg / bag 25 kg	16,20 €
1080236	Kvarcni pesak 0.4/0.8 / sand quartz 0.4/0.7	Paleta 63 džaka, ili 1575 Kg - pallet 63 bags, ie 1575 Kg	924,90 €
GRANIGLIA / GRITS			
1080239	Granulat tipo 1/2 / grits 1/2	Po džaku od 25 Kg / bag 25 kg	17,20 €
1080231	Granulat tipo 3/5 / grits 3/5	Po džaku od 25 Kg / bag 25 kg	20,30 €
1080234	Granulat 10/20 / grits 10/20	Po džaku od 25 Kg / bag 25 kg	16,70 €
DIATOMEA / DIATOMS			
1080086	Diatomea u džaku od 25 kg	Po džaku od 25 Kg / bag 25 kg	84,00 €
ANTRACITE / ANTHRACITE			
1080238	Antracite filtrirajući / filtering anthracite	Po džaku od 25 Kg / bag 25 kg	120,00 €
1080240	Antracite filtrirajući 1.2/2.5	Po džaku od 25 Kg / bag 25 kg	120,00 €

VFE FILTRIRAJUĆE STAKLO ECO

V.f.e. FILTRIRAJUĆE STAKLO eco validna je alternativa silicijum pesku: dobijen od recikliranog stakla, ne zahteva agresivne radnje vađenja ili korišćenje već manjkavih sirovina. Zahvaljujući obliku granula, sa ivicama oštrim ili zaobljenim, i sadržaju vezanog silicijuma njegova efikasnost u otklanjanju mutnoće rezultira 30% većom od one silicijum peska.

Manje je gustine od peska a 15% manje proizvoda je dovoljno da napuni isti filter. Ne raspada se. Ima tako duži vek trajanja i nije ga potrebno zamenjivati.

V.f.e. Eco Glass Filter is a viable alternative to silica sand: obtained from recycled glass, does not require intrusive mining activities or the exploitation of scarce resources. Thanks to the shape of the granules, with sharp or rounded edges, and the content of bound silica, its effectiveness in removing the turbidity is 30% higher than the silica sand one. It's less dense than the sand and the 15% of product in less is enough to fill the same filter. It does not degrade. Therefore it has a longer life cycle and it's not necessary to replace it.

Šifra /code	Opis /description	Džak	Cena/price
1080237	Filtrirajuće staklo tip 0.5/1.25 / eco glass 0.5/1.25	Po džaku od 25 kg / bag 25 kg	25,40 €
1080229	Filtrirajuće staklo tip 1/3 / eco glass 1/3	Po džaku od 25 kg / bag 25 kg	25,40 €
1080228	Filtrirajuće staklo tip 3/6 / eco glass 3/6	Po džaku od 25 kg / bag 25 kg	27,50 €



**DŽAKOVI SOLI ZA ELEKTROLIZU
BAGS OF SALT FOR ELETROLYSIS**

Rafinisana so, rekristalizovana na ključanje, visoke solventnosti (100%) prvo bez taloga i stranih minerala, idealan za uređaj elektrolize (u granularnom obliku) i raslađivača (u tabletama). Posebno se preporučuje za Premio+ e Autochlor.

Refined salt, recrystallized from boiling, high solubility (100%) free of debris and foreign minerals, ideal for electrolysis plants and water softeners. Specifically recommended for Premio + and Autochlor.

Šifra /code	Opis /description	Cena/price
1075018	Specijalna so u tabletama – džak od 25 kg / Special salt tablets - 25 kg bag	19,80 €
1075019	Specijalna granularna so – džak od 25 kg / Special salt granular - 25 kg bag	18,40 €



POMPE CON PREFILTRO

SERIE AMBRA 50
 SERIE AMBRA 75
 SERIE AMBRA 100
 SERIE AMBRA 150
 SERIE AMBRA 200
 SERIE AMBRA 300



SERIE SERENA 100
 SERIE SERENA 300



SERIE CARRERA 50
 SERIE CARRERA 75
 SERIE CARRERA 100
 SERIE CARRERA 150
 SERIE CARRERA 200
 SERIE CARRERA 300



SERIE VIENNA 50
 SERIE VIENNA 75
 SERIE VIENNA 100
 SERIE VIENNA 150
 SERIE VIENNA 200
 SERIE VIENNA 300
 SERIE VIENNA 400S



SERIE BADU ENERGY 8
 SERIE BADU ENERGY 12
 SERIE BADU ENERGY 14
 SERIE BADU ENERGY 20
 SERIE BADU ENERGY 25



POMPA BADU ECO TOUCH PRO
 A VELOCITÀ VARIABILE
 BADU ECO TOUCH PRO
 VARIABLE SPEED PUMP



SERIE BRETON 250S
 SERIE BRETON 370S
 SERIE BRETON 550S
 SERIE BRETON 750S



POMPA BADU ECO MOTION
 A VELOCITÀ VARIABILE
 BADU ECO MOTION
 VARIABLE SPEED PUMP



E.SWIM A VELOCITÀ VARIABILE DAB
 E.SWIM VARIABLE SPEED DAB



POMPE SENZA PREFILTRO

SERIE ARCA 550
 SERIE ARCA 750
 SERIE ARCA 1100A
 SERIE ARCA 1500A

PER IDROMASSAGGIO
 FOR HYDROMASSAGE



SERIE ADRIA MINI 1,5 CV
 SERIE ADRIA MINI 2 CV
 SERIE ADRIA MINI 3 CV
 SERIE ADRIA NEW 3 CV
 SERIE ADRIA NEW 4 CV
 SERIE ADRIA NEW 5 CV

PER NUOTO CONTRO CORRENTE
 E IDROMASSAGGIO
 FOR COUNTER CURRENT SYSTEM
 AND HYDROMASSAGE



SERIE WP300-II
 POMPE IDROMASSAGGIO PER SPA
 HYDROMASSAGE SPA SERIES



SERIE ARCA 2200
 SERIE ARCA 3200

PER NUOTO
 CONTRO CORRENTE
 FOR COUNTER
 CURRENT SYSTEM



**SERIE POMPE AMBRA
PUMP AMBRA SERIES**



Centrifugalne elektropumpe za recikulaciju i filtriranje vode u male i srednje bazene sa ugrađenim predfilterom. Mogu se koristiti sa koncentracijom soli u vodi do 0,4% - 4 gr/l.

UPOTREBA

- Maksimalna radna temperatura 40°C
- Maksimalna temperatura vode 40°C
- Maksimalni usis glave pumpe: 3 m
- Pumpana tečnost: čista, bez tvrdih tela i abrazivnih supstanci, neagresivna, nelepljiva i hemijski neutralna.

MOTOR I KARAKTERISTIKE:

- Bipolarni asihroni motor TEFC
- Čelični kardan motora AISI 316L.
- Mehanično keramička-grafitna zaptivka metalni deo AISI 316.
- Izolacija klasa F
- Stepen zaštite IP55
- Kontinuirani rad S1
- Monofazno napajanje 230V-50Hz sa termičkom zaštitom ili trofazno 230/400V-50Hz
- Spojevi Ø63 mm

Centrifugal pump for recirculation and filtration of the water in small and medium sized pools with prefilter integrated.

Available for water with salt concentration up to 0,4% - 4 gr./l.

OPERATING CONDITIONS

- *Max. ambient temperature 40°C*
- *Max. water temperature 40°C*
- *Max. suction head up to 3 m*
- *Liquid condition: clean liquids, without solids or abrasive substances, non-aggressive, non-viscous, chemically neutral.*

MOTOR AND FEATURES

- *Closed asynchronous two poles motor TEFC*
- *Motor shaft in AISI 316L steel.*
- *Mechanical seal ceramic-graphite metal part AISI 316.*
- *Insulation class F*
- *Protection degree IP55*
- *Continuous operation S1*
- *Power supply: single-phase 230V-50Hz with thermal protection or three-phase 230/400V-50Hz.*
- *In/outlet Ø63 mm*



MADE IN ITALY



**VISOK UČINAK
HIGH PERFORMANCE**



**ENERGETSKA UŠTEDA
ENERGY SAVING**



**TIHA
SILENT**

Model	AMBRA 50	AMBRA 75	AMBRA 100	AMBRA 150	AMBRA 200	AMBRA 300
H m	8	8	8	8	8	8
Q m ³ /h	12	15	17,5	21	23	30

Šifra monofaza/ mono-phase code	Šifra trifase/ three-phase code	Model/model	Snaga HP/ PowerHP	Snaga kW/ power kW	V 1 ~ 50 HZ 3 ~ 50 HZ	A 1 ~ 230 3 ~ 400	Cena monofaza/ monophase price	Cena trifase/ three-phase price
1090201	1090202	PUMPA/PUMP AMBRA 50	0,50	0,37	230 400	3,4 1,4	523,00 €	519,70 €
1090203	1090204	PUMPA/PUMP AMBRA 75	0,75	0,55	230 400	4,8 1,8	539,60 €	533,40 €
1090205	1090206	PUMPA/PUMP AMBRA 100	1,00	0,75	230 400	5 2,2	548,50 €	543,60 €
1090207	1090208	PUMPA/PUMP AMBRA 150	1,50	1,10	230 400	6 2,7	666,70 €	655,90 €
1090209	1090210	PUMPA/PUMP AMBRA 200	2,00	1,50	230 400	7 3,1	691,50 €	669,50 €
1090211	1090212	PUMPA/PUMP AMBRA 300	3,00	2,20	230 400	10 4,3	717,80 €	705,20 €

POMPE DI FILTRAZIONE

PUMPE ZA FILTRIRANJE

DIMENZIJE / DIMENSIONS

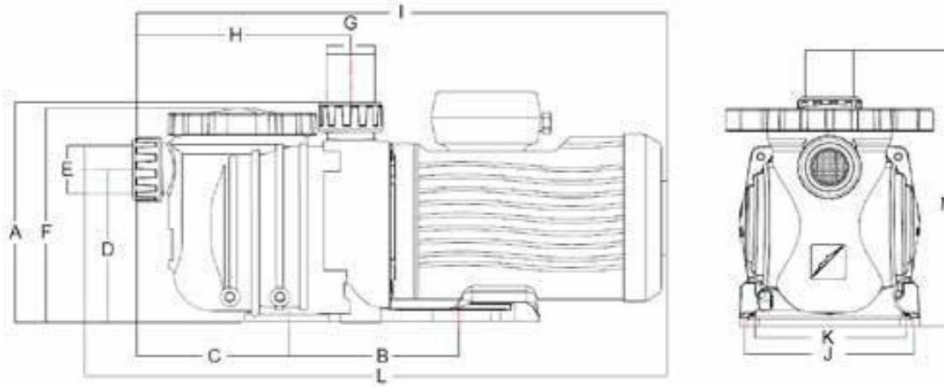

Model	A	B	C	D	E	F	G	H	I	J	K	L	M
PUMPA AMBRA 50	266	134	229	198	Ø63	273	Ø63	280	600	190	154	626	292
PUMPA AMBRA 75	266	134	229	198	Ø63	273	Ø63	280	600	190	154	626	292
PUMPA AMBRA 100	266	134	229	198	Ø63	273	Ø63	280	600	190	154	626	292
PUMPA AMBRA 150	266	134	229	198	Ø63	273	Ø63	280	620	190	154	626	292
PUMPA AMBRA 200	266	134	229	198	Ø63	273	Ø63	280	620	190	154	626	292
PUMPA AMBRA 300	266	134	229	198	Ø63	273	Ø63	280	620	190	154	626	292

PERFORMANSE / PERFORMANCES

H (m)

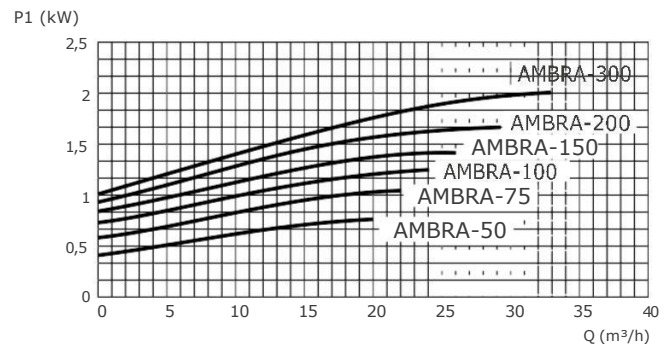
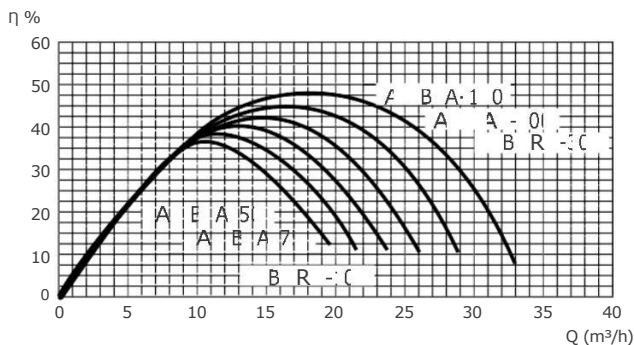
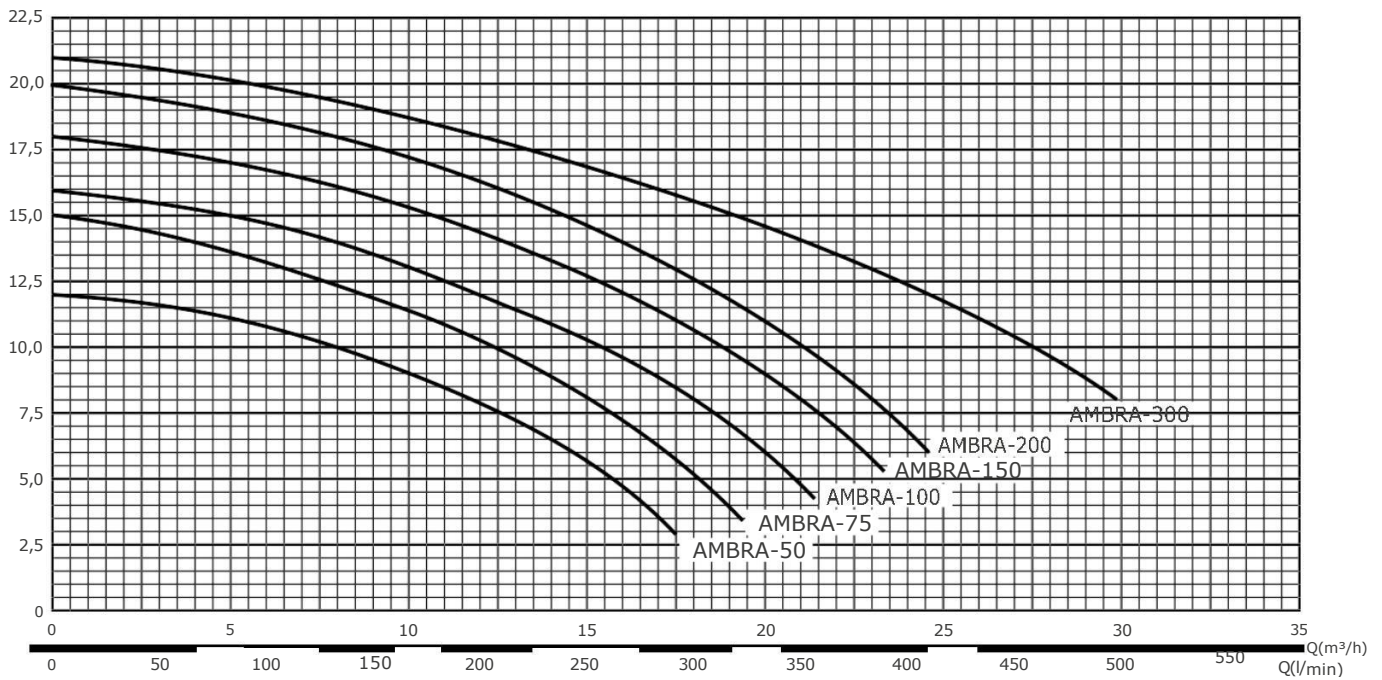

SERIJE SERENA
SERENA SERIES



SERENA 300



SERENA 100



Centrifugalna pumpa sa motorom sa trajnim magnetima za recirkulaciju i filtriranje vode bazena sa ugrađenim predfilterom.

UPOTREBA

- Maksimalna radna upotreba 40°C
- Maksimalna temperatura vode 40°C
- Maksimalni usis glave pumpe: 3 m
- Motor Brushless sa ugrađenim izmenjivačem frekvence
- Pumpana tečnost: čista, bez tvrdih tela ili abrazivnih supstanci, neagresivna, ne lepljiva i hemijski neutralna.
- Upotrebljiva sa vodom sa koncentracijom soli 0,4%-4gr/l

MOTOR I KARAKTERISTIKE

- Motor sa trajnim magnetima sa ugrađenim višeparametarskim kontrolerom.
- Čelični kardan motora AISI 316L.
- Mehaničko keramičko-grafitna zaptivka metalni deo AISI 316.
- Izolacija klasa F
- Stepen zaštite IP55
- Kontinuirani rad S1
- Monofazno napajanje 230V-50Hz sa termičkom zaštitom
- Spojevi Ø63 mm

Centrifugal pump with permanent magnet motor for recirculation and filtering of water in swimming pools with built-in pre-filter.

OPERATING CONDITIONS

- Max. ambient temperature 40°C
- Max. water temperature 40°C
- Max. suction head up to 3 m
- Brushless motor with on board frequency controller
- Liquid condition: clean liquids, without solids or abrasive substances, non-aggressive, non-viscous, chemically neutral.
- Can be used with water up to a salt concentration of 0.4% - 4 gr/l

MOTOR AND FEATURES

- Permanent blow motor with on-board multi-parameter controller
- Motor shaft in AISI 316L steel.
- Mechanical seal ceramic-graphite metal part AISI 316.
- Insulation class F
- Degree of protection IP55
- Continuous operation S1
- Single-phase 230V-50Hz power supply with thermal protection power supply
- Connections Ø63 mm

IMPIANTO/EQUIPMENT



Serena raspolažesa jednim višeparametarskim kontrolerom sa ugrađenim ekranom, koji omogućava programiranje direktno unutar pumpe, bez potrebe spoljnog kontrolora. Za daljinsko upravljanje može se priključiti na inovacioni sistem od kuće Merlino (vidistr. 2)

Modbus, raspolažesa spoljnim vratima za konekciju, protokol

Serena is equipped with a multi-parameter controller with an integrated display, allowing it to be programmed directly on the pump, without the need for an external controller. For remote management it can be combined with the innovative Merlino automation system (see p. 211). Equipped with port for external connection, Modbus protocol.

Šifra/ code	Model/model	Snaga HP/ Power HP	Snaga kW / power kW	V 1 ~ 50 HZ 3 ~ 50 HZ	Težina/ weight Kg	Cena/ price
1090213	SERENA 1 HP	1	0,75	230	16	1.386,00 €
1090214	SERENA 3 HP	3	2,2	230	25	2.233,00 €

POMPE DI FILTRAZIONE

DIMENZIONI I UČINAK SERENA 100 / DIMENSIONS AND PERFORMANCES SERENA 100

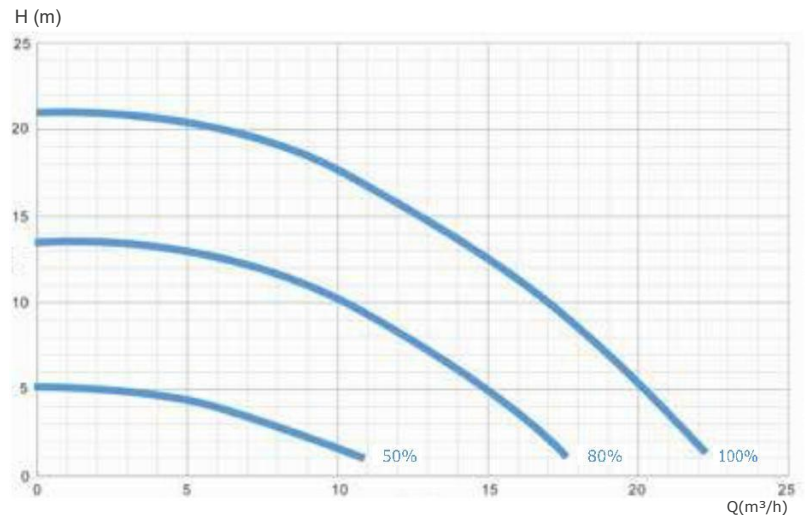
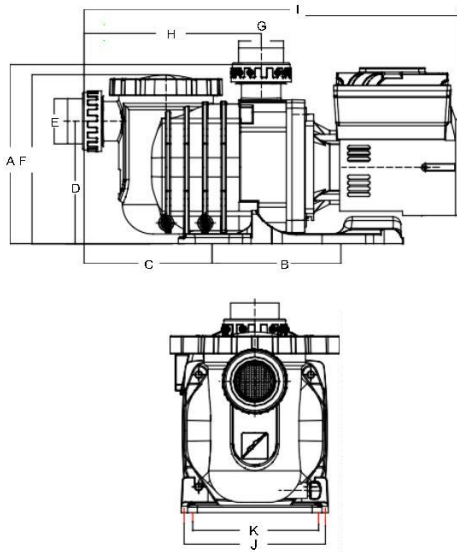

Model	A	B	C	D	E	F	G	H	I	J	K
PUMPASERENA100	266	134	229	198	Ø63	273	Ø63	280	610	190	154

Šifra	Snaga [hp]	Snaga [kW]	Obrtaj m. [min]	potrošnja [W]	H [m]	Q [m³/h]	V[1~50/60Hz]	A[1~230]
1090213	1	0,75	1555	100-160	4	6	230	1,4-10,0
			2735	340-800	10	10		
			3450	600-1400	13	15		

DIMENZIONI I UČINAK SERENA 300 / DIMENSIONS AND PERFORMANCES SERENA 300

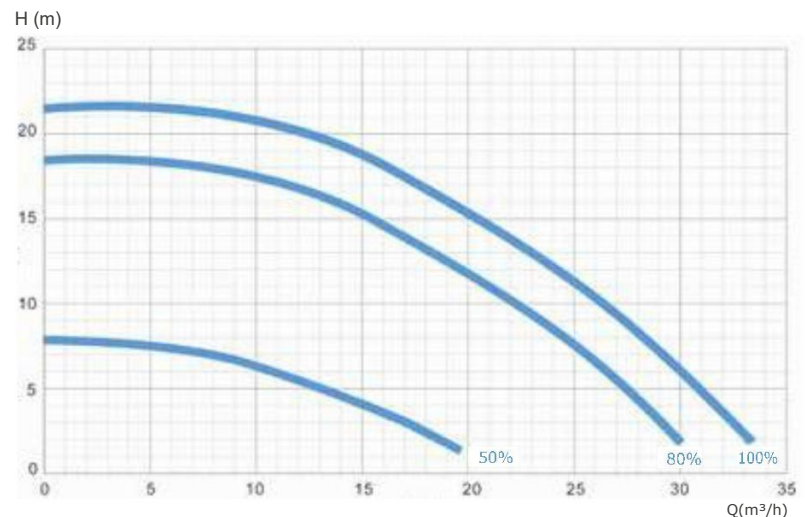
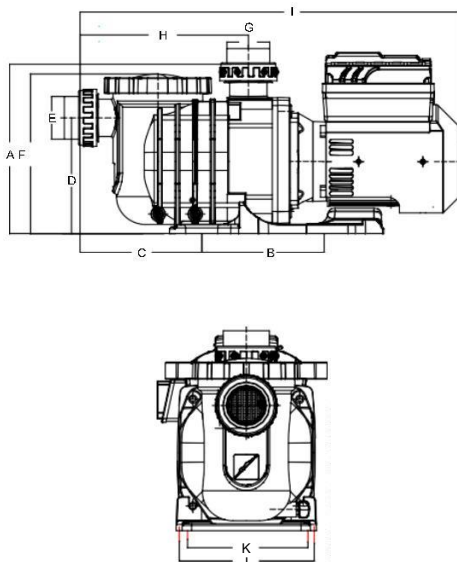

Model	A	B	C	D	E	F	G	H	I	J	K
PUMPASERENA300	266	134	229	198	Ø63	273	Ø63	280	646	190	154

ŠIFRA	Snaga [hp]	Snaga [kW]	Obrtaj m. [min]	Potrošnja [W]	H [m]	Q [m³/h]	V[1~50/60Hz]	A[1~230]
1090214	3	2,2	1725	70-140	6,3	10	230	2,0-11,0
			2750	220-500	15,5	15		
			3000	700-1800	14	22		

FILTRACIONE PUMPE

SERIE BRETON BRETON SERIE



BRETON 250S



BRETON 550

- Cirkulacija vode u uređajima za filtriranje vode
- Centrifugalne pumpe sa predfilterom

TELO

- Telo pumpe, baza i difuzor od polipropilena
- Rotor od Norylona
- Nosač zaptivke od stakla i polyamida
- Vratilo motora od čelika inox AISI420
- Mehanička zaptivka grafitna i od steatita
- Obloga motora od aluminijuma L-2521

MOTOR

- Impregimirani navoji od epoxidne smole
- Asinhroni, dvopolni, 2800 obrtaja
- Zaštita IP55
- Izolacija klasa F
- Kontinuirani rad
- Verzije monofazne i trofazne
- Termička zaštita integrisana u monofaznoj verziji

- Water circulation in swimming pool filtration systems.
- Centrifugal pumps complete with prefilter

BODY

- pump body, base, diffuser in polypropylene
- impeller in Noryl
- support seal in glass and polyamide
- motor shaft in stainless steel AISI 420
- Mechanical seal in graphite and steatite
- Motor housing in aluminum L-2521
- Windings impregnated with epoxy-resin

ENGINE

- Asynchronous, two poles, 2800 rpm
- Protection IP55
- Insulation class F
- Continuous operation
- Version one phase and three-phases
- Thermal protection integrated in-phase

Šifra mono-fazna	Šifra trofazna	Model	Snaga HP	Snaga kW	H m	Q m ³ /h	H m	Q m ³ /h	V 1~50HZ 3~50HZ	A 1~230 3~400	Cena monofazna	Cena trofazna
2220236	-	Breton 250S	0,33	0,25	6	5	8	3	230 -	1,7 -	168,40 €	-
2220220	2220221	Breton 370S	0,5	0,37	6	13	8	12,5	230 400	3,6 1,4	262,40 €	256,20 €
2220222	2220223	Breton 550S	0,75	0,55	6	15,5	8	14,5	230 400	5,1 1,9	273,60 €	267,40 €
2220224	2220225	Breton 750S	1	0,75	6	18	8	16	230 400	5,8 2,2	288,20 €	282,20 €

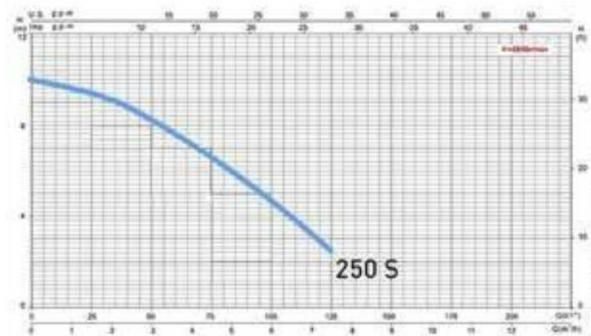
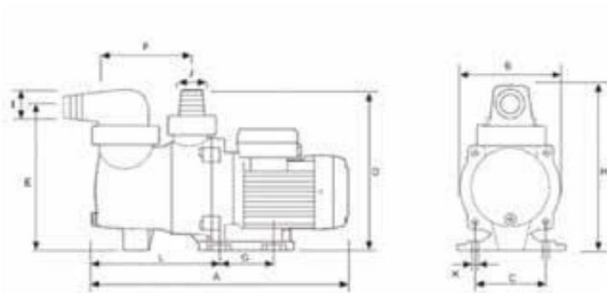

DIMENZIJE / DIMENSIONS - MODEL BRETON 250S

A mm	B mm	C mm	D mm	E mm	F mm	G mm	H mm	L mm	I mm	J mm	K mm	Težina mm
400	160	100	250	231	158	90	210	205	Ø40	Ø50	4-Ø9	5,6

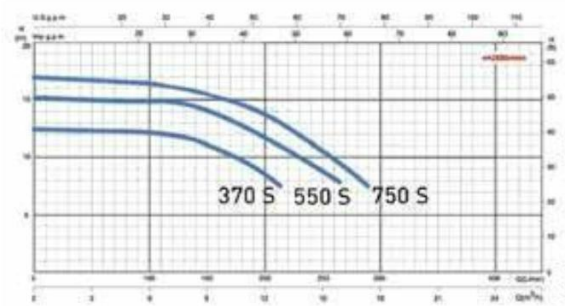
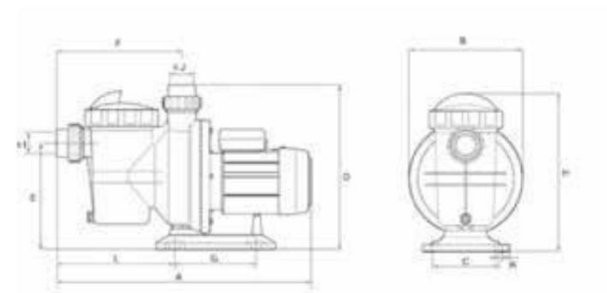

DIMENZIJE / DIMENSIONS - MODEL BRETON 370S/550S/750S

A mm	B mm	C mm	D mm	E mm	F mm	G mm	H mm	L mm	I mm	J mm	K mm	Težina mm
550	238	160	345	225	262	170	330	205	Ø50	Ø50	4-Ø10	8,7-9,3-10,4

FILTRACIONE PUMPE

SERIJE CARRERA CARRERA SERIES



- Protok vode u filtracionim uređajima za bazene
- Centrifugalne pumpe sa prefilterom

TELO

- Poklopac, telo pumpe i difusor od Norylona
- Rotor od Norylona
- Nosač zaptivke od stakla i poliamida
- Vratilo motora od čelika inox AISI 316
- Namotaji su impregnirani eposidičnom smolom

MOTOR

- Asinhrono, dva pola, 2850 giri
- Zaštita IP55
- Izolacija klasa F
- Kontinuirani rad
- Verzije monofazne i trofazne

- Water circulation in swimming pool filtration systems.
- Centrifugal pumps complete with prefilter

BODY

- Cover, pump body and diffuser in Norylon
- Impeller in Noryl

ENGINE

- Asynchronous, two poles, 2850 rpm
- Protection IP55
- Insulation class F
- Continues operation
- Single and three phase version

Šifra monofaza/ code mono-phase	Šifra trofazna/ code three-phase	Opis / description	Snaga/ Power HP	Snaga/ power kW	V 1~50HZ 3~50HZ	A 1~230 3~400	Cena monofaza/ Price mono- phase	Cena trofazni/p rice three-
1090088	1090089	Carrera 50	0,5	0,37	230 400	3 1,4	584,70 €	579,60 €
1090101	1090102	Carrera 75	0,75	0,55	230 400	3,5 1,6	617,60 €	613,00 €
1090080	1090084	Carrera 100	1	0,75	230 400	5 2,6	641,30 €	632,00 €
1090081	1090085	Carrera 150	1,5	1,1	230 400	7 2,5	754,90 €	735,90 €
1090082	1090086	Carrera 200	2	1,5	230 400	9 3,5	863,50 €	839,90 €
1090083	1090087	Carrera 300	3	2,2	230 400	12 5,2	925,20 €	901,50 €

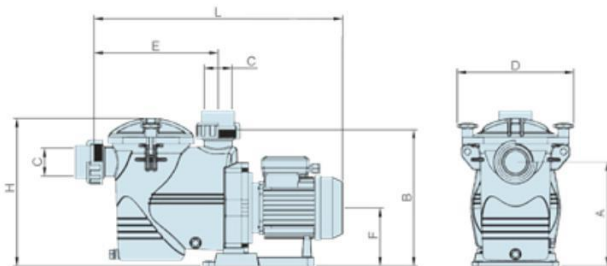

DIMENZIJE / DIMENSIONS

A mm	B mm	C mm	D mm	E mm	F mm	H mm	L mm
235	308	Ø 63	290	282	132	335	563

Model	50	75	100	150	200	300
Težina / Kg	12,9	13,4	14,4	17,4	19,9	22,9

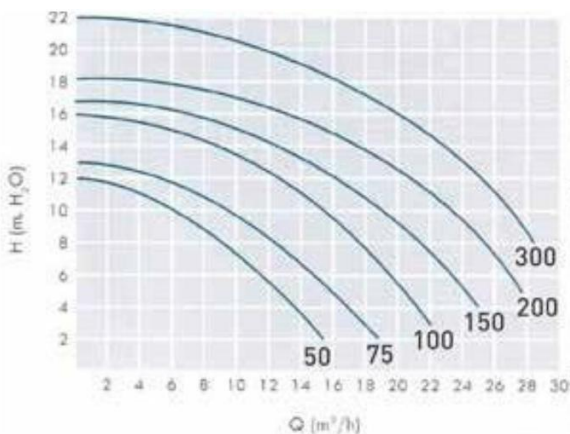

Model	H m	Q m³/h	H m	Q m³/h
Carrera 50	6	12	8	9
Carrera 75	6	15	8	12
Carrera 100	6	20	8	18
Carrera 150	6	24	8	22
Carrera 200	6	27	8	25,5
Carrera 300	6	29	8	28,5

FILTRACIONE PUMPE

SERIE SPECK BADU ENERGY SPECK BADU ENERGY SERIES



- Protok vode u uređajima za filtraciju za bazene. Instalacija maksimalno 3 metra iznad i 3 metra ispod nivoa vode. Pumpa može funkcionisati sa koncentracijom soli u vodi od 0.5% (=5g/l)
- Kompaktna pumpa sa predfilterom. Mehanička zaptivka zatvorena, montirana na glavčini rotora plastificirano. Ugljen/ keramika/NBR
- Vratilo motora ne dolazi u kontakt sa vodom bazena. Električna separacija
- Zaštita IP55
- Izolacija klasa F
- Verzije monofazne i trofazne
- Water circulation in swimming pool filtrationsystems. Installation a maximum of 3 meters above or 3 meters below the water level. The pump can work with a salt concentration of 0.5% (=5 g/l)
- Compact pump with pre-filter.
- Mechanical seal closed, assembled on plastic impeller hub. In carbon/ceramic/ NBR
- motor shaft not in contact with pool water
- electrical separation
- protection IP55
- insulation class F
- one phase and three phases version

Šifra monofaza/ code mono- phase	Šifra trofazna/co de three- phase	Opis / description	Snaga/ Power HP	Snaga/ power kW	1 ~ 50HZ	3 ~ 50HZ	1 ~ 230HZ	3 ~ 400HZ	Cena mono- faze/Price mono- phase	Cena tro- fazni/pric e three- phase
1090022	1090023	SPECK BADU ENERGY 8	0,3	0,3	230	400	0,95	1,65	819,40 €	819,40 €
1090024	1090025	SPECK BADU ENERGY 12	0,43	0,45	230	400	1,25	2,15	863,60 €	863,60 €
1090026	1090027	SPECK BADU ENERGY 14	0,63	0,65	230	400	1,75	3,00	1.023,40 €	1.023,40 €
1090028	1090029	SPECK BADU ENERGY 20	1,34	1	230	400	2,5	4,30	1.467,10 €	1.467,10 €
1090030	1090031	SPECK BADU ENERGY 25	1,75	1,3	230	400	3	5,20	1.538,50 €	1.538,50 €

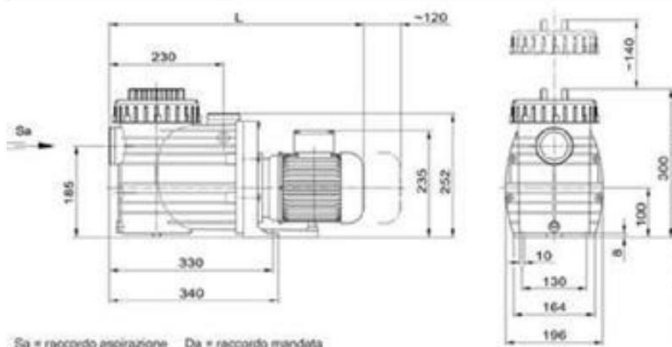

Da = raccordo aspirazione Da = raccordo mandata

DIMENZIJE / DIMENSIONS

Model	H m	Q m ³ /h	H m	Q m ³ /h	L mm
8	6	10	8	8,5	49
12	6	12,5	8	11	49
14	6	16	8	14	505
20	6	21	8	20	517
25	6	26	8	25	517

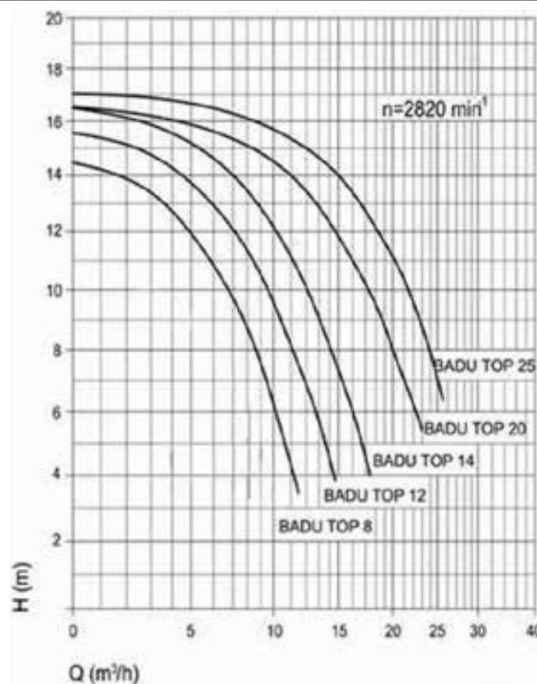

UNIVERZALNA KOLICA ZA PUMPE / PUMPS CARRIAGE



Šifra / code	Opis /description	Cena/ price
1025130	Univerzalna kolica za pumpe od čelika inox Stainless steel universal pump carriage	284,80 €

FILTRACIONE PUMPE

PUMPA BADU ECO TOUCH PRO SA VARIABILNOM BRZINOM / BADU ECO VARIABLE SPEED



- Kompaktne pumpe sa prefilterom sa variabilnom brzinom i motorom sa permanentim magnetima.
 - Upravljanje putem uprošćenog interfejsa na pumpi za odabir brzine radai pregledapotrošnje.
 - Mogućnost instalacije do 3 metra ispod i iznad nivoa.
 - Energetska ušteda garantovana personalizovanjem brzine obrtaja motora, u funkciji zahteva funkcionisanja uređaja.
 - Mehanička zaptivka zatvorena montirana na plastificiranoj glavčini rotora.
 - Vratilo motora ne dolazi u kontakt
 - Sa vodom bazena.Elektro separacija.
- *Compact pumps with prefilter, variable speed and permanent magnets motor.*
 - Settingthroughasimplifiedinterface board pump for selection of the operating speed and visualization of consumption.
 - Can be installed up to 3 meters above and belowhead.
 - Saving opportunities by setting the desired speed of the motor, according to the requirements of plant operation.
 - Mechanical seal closed assembled on plastic impeller hub. T

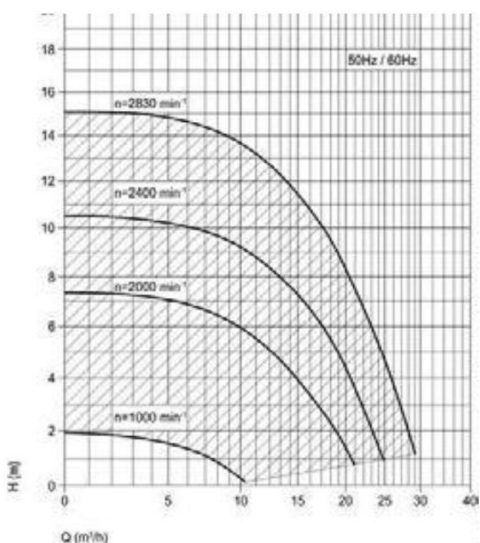

- Pumpa može funkcionisati sa sonom kiselinom vode do 5g/l



Komanda Badu Eco Logic
Badu Eco Logic control

Energy Control

Modul HIDRO i multi step
Hydroandmulti-stepmodule

BaduEco touch može biti kontrolisana i od strane Energy Control putem modula hidromasaže i multi brzine. Badu Eco touch can be controlled by the energy control panel using the hydro and multi-step module.

Šifra/code	Opis/description	Cena/price
1090032	Pumpa Badu Eco Touch Pro sa varijabilnom brzinom / Pump Badu Eco Touch Pro variable s	2.718,30 €
1090039	Komadna tabla Badu Eco Logic / Control panel Badu Eco Logic	1.205,70 €

Šifra	Obrtaj motor [min]	Snaga [kW]	H [m]	Q [m³/h]	V [1 ~ 50 / 60 Hz]	A [1 ~ 230]
1090032	2000	0,4	6	10	230	0,6 - 6,50
	2400	0,7	8	13		
	2830	1,05	8	20		

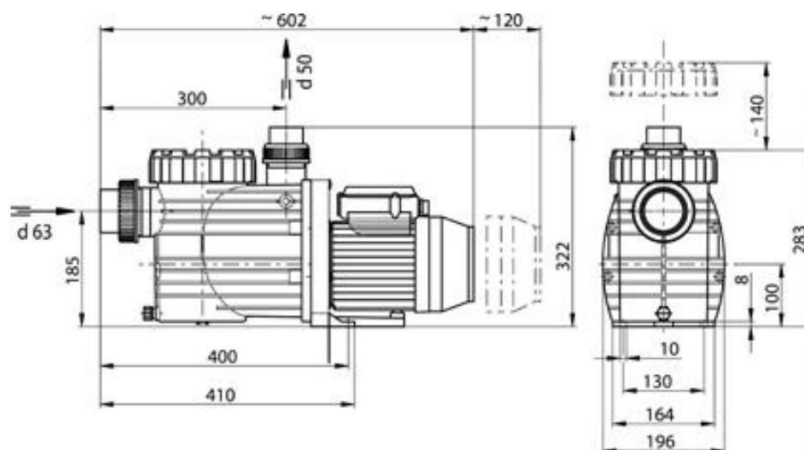

FILTRACIONE PUMPE

PUMPA BADU ECO FLEX SA VARIJABILNOM BRZINOM BADU ECO FLEX VARIABLE SPEED PUMP



- PUMPA sa varijabilnom brzinom i asihronim monofaznim motorom, sa modularnim inverterom, sa predfilterom i samousisom.
- Jednostavni ekran za kontrolu i programiranje parametara rada
- Memorisana konfiguracija i bez električnog napajanja.
- Mehanički zaptivač zatvoren montiran na plastificiranoj glavčini rotora, ne dolazi u kontakt sa vodom bazena.
- Elektro separacija
- Pumpa može funkcionisati sa sonon koncentracijom vode od 0,5% (= 5 g/l)
- Variable speed pump and asynchronous single phase motor, with amodularinverter, complete with pre-filter and self-priming
- Simple display for the control and programming of the operating parameters
- Configuration stored even in the event of a power failure electric
- Closed mechanical seal mounted on plastic-coated impeller hub, the motor shaft does not come into contact with the pool water.
- Electrical separation.
- The pump can operate with a salt concentration of water by 0.5% (= 5 g / l)

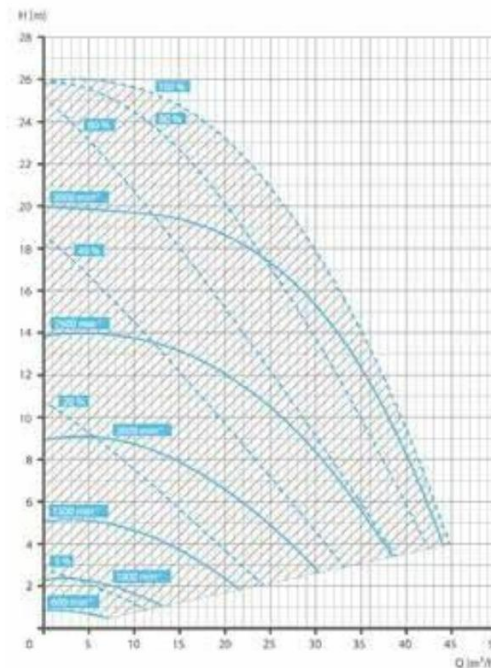

Šifra/code	Opis/description	Cena/price
1090076	Pumpa Badu Eco Flex sa variabilnom brzinom/Pump Badu Eco FLEX variable speed	4.318,00 €

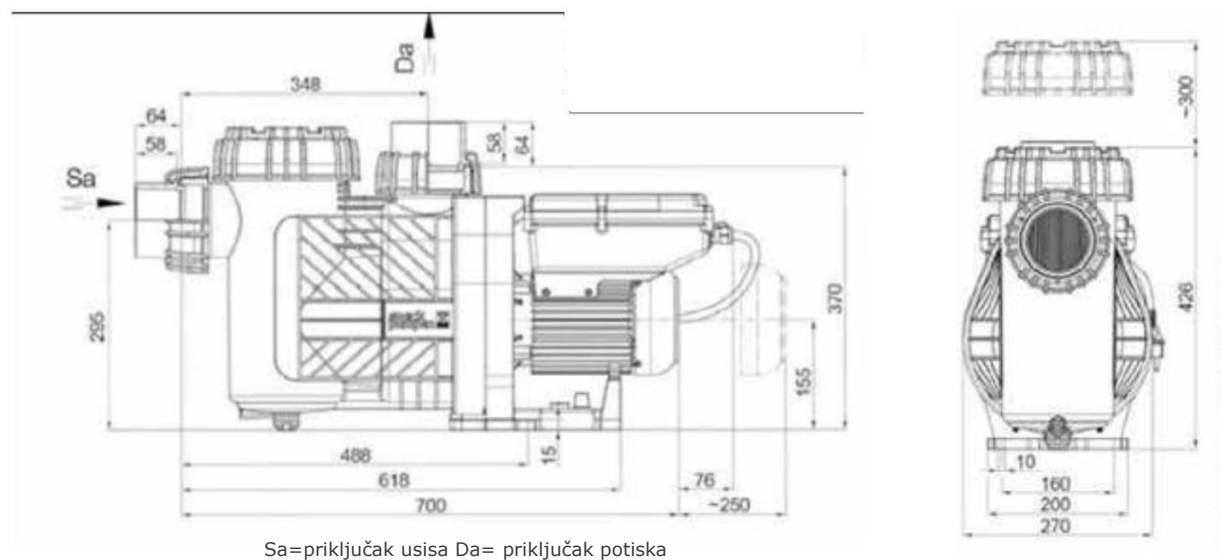

Šifra	Obrtaj motora min	H m	Q m³/h	V 1 ~ 50 / 60 Hz	usis kW	Resa kW	Nominal na struja A	Ø spojevi mm	Težina
1090076	1000	2	8	230	0,08-2,60	0,05-2,20	0,45-12,00	90	24,5
	1500	4,7	10						
	2000	7,9	15						
	2500	12	20						
	3000	15,2	30						

FILTRACIONE PUMPE

E.SWIM VARIABILNE BRZINE DAB E.SWIM VARIABLE SPEED DAB



Elektronska pumpa za bazen variabilne brzine sa predfilterom. Tehnologija inverter kombinovana motoru brushless koji se hladi ubrizganom tečnošću omogućava maksimalnu energetska uštedu i obezbeđuje najviši nivo komforta što se tiče tišine. Lakoća očitavanja i programiranja zahvaljujući interfejsu korisnika sa LCD ekranom i integrisanim softverom za dijagnostiku za zaštitu pumpe i uređaja. Rad sa kontrolom brzine ili protoka za što bolju prilagodljivost raznim uređajima bazena. Jednostavnost upravljanja konekcije na daljinu putem kablova. Podobna i za slanu vodu.

Electronic variable speed pump for swimming pool complete with pre-filter. The inverter technology combined with the brushless motor cooled by the pumped liquid allows maximum energy savings and ensures the highest level of comfort in terms of quietness. Ease of reading and programming, thanks to the user interface with LCD display and to the integrated diagnostic software for the protection of the pump and the plant. Operation with speed or flow control, for greater adaptability to different swimming pool systems. Easy operation via remote cable connection. Also suitable for saltwater.

KARAKTERISTIKE / FEATURES:

TELO

- Telo pumpe, filter, rotor i difuzor od technopolimera ojačanog fibreglasom.
- Poklopac predfiltera od polikarbonata.
- Mehanično zaptivanje od karbon / alumina / NBR / AISI 316
- O-prsten telo pumpe od NBR

MONOFAZNI MOTOR

- SinHRONI permanentnih magneta, ugrađeni magnetizirani rotor. Hladene na vodu (bez elise)
- Zaštita IPX5, Izolacija klasa F
- Rad do 30 m³/h sa prevagom do 15,4 m
- Maksimalni pritisak rada 2,5 bar

KONTROLNI PANEL

- Posедуje 4 postavljena prekidača sa 8 brzina koje se mogu programirati
- LED sa indikatorom: alarmi, napajanje, funkcija
- Ugrađeno vremensko planiranje
- Široki ekran LCD pokazuje vreme izvršenja, modaliteti i trenutno stanje.
- Sistem zaštite protiv zamrzavanja

BODY

- Body pump, filter, impeller and diffuser in technopolymer reinforced with glass fibers
- Prefilter lid in polycarbonate
- Mechanical seal in carbon / alumina / NBR / AISI 316
- O-ring pump body in NBR

- programmable speeds
- LED with indication of: alarms, power supply, operation
- Integrated time planning
- Large LCD display for the execution time, mode and instant status
- Anti-freezing protection system



Šifra	Model	Snaga HP	Snaga kW	H m	15,7	14,4	12,2	10,9	9,4	7,9	6,3	V 50 HZ	Prezzo Kg	Cena
1090105	E.SWIM150	1,5	1,1	Q m ³ /h	6	12	18	21	24	27	30	230	19	2.744,70 €

DIMENZIJE(mm)/DIMENSIONS:

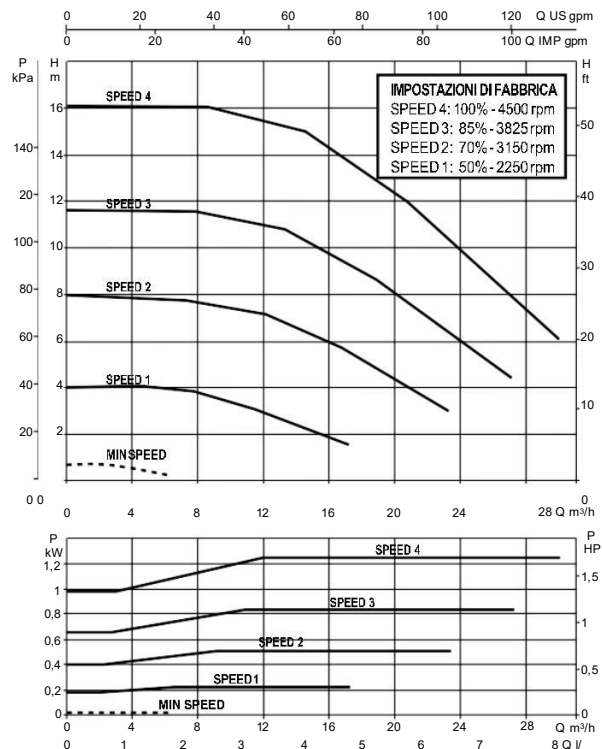
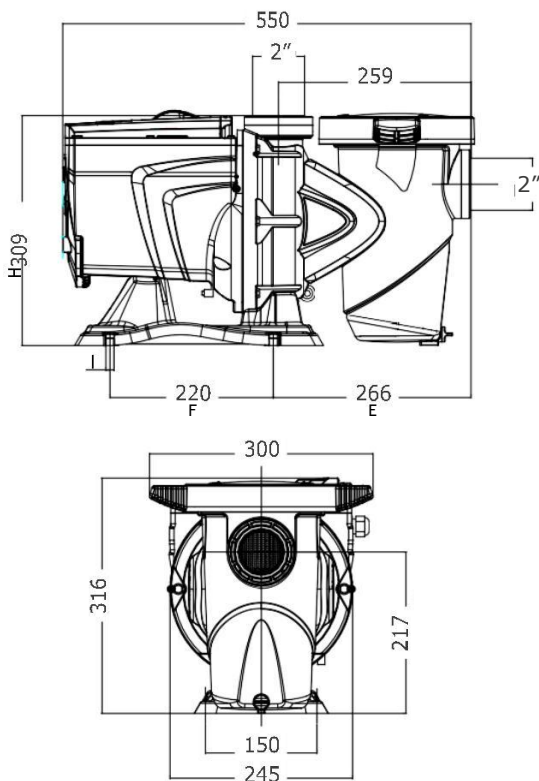

SERIJE VIENNA VIENNA SERIES



vienna 100-150-200



vienna 300-400S

- Protok vode u uređajima za filtraciju za bazene.
 - Pompe centrifughe complete di prefiltro
 - Watercirculationinswimmingpool filtration systems.
 - Centrifugal pumps complete with prefilter
- TELO**
- Telo pumpe in PP i fibreglasu
 - Poklopac pumpe in PPO i fibreglasu
 - Providni poklopac inPC
 - Vratilo od čelika inoxAISI 420
 - Mehanički zaptivač SiC-Keramika
 - Aluminijumska obloga motora L-2521
- BODY**
- pump body in PP and fiberglass
 - pump cover in PPO and fiberglass
 - Transparent cover inPC
 - motor shaft in stainless steelAISI 420
 - Mechanical seal inSiC-ceramic
 - Motor housing in aluminum L-2521

ŠIFRA monofaze	Šifra trifaze	Model	Snaga HP	Snaga kW	H m	Q m ³ /h	H m	Q m ³ /h	V 1~50HZ 3~50HZ	A 1~230 3~400	Cena monofaze	Cena trifaze
2220800	2220801	Vienna 50	0,5	0,37	6	14	8	10,5	230 400	3,1 1,2	315,10 €	309,20 €
2220802	2220803	Vienna 75	0,75	0,55	6	17,5	8	15	230 400	4,2 1,6	323,90 €	317,70 €
2220264	2220270	Vienna 100	1	0,75	6	19	8	17	230 400	5,3 2,0	331,90 €	325,70 €
2220266	2220271	Vienna 150	1,5	1,1	6	23	8	21	230 400	7,2 3,0	405,80 €	399,60 €
2220268	2220272	Vienna 200	2	1,5	6	25	8	23	230 400	9,4 3,7	428,30 €	422,10 €
2220273	2220274	Vienna 300	3	2,2	10	35,5	12	33	230 400	12,5 2,7	528,10 €	521,90 €
-	2220275	Vienna 400S	4	3	10	48	12	43	-400	6,4	-	703,00 €

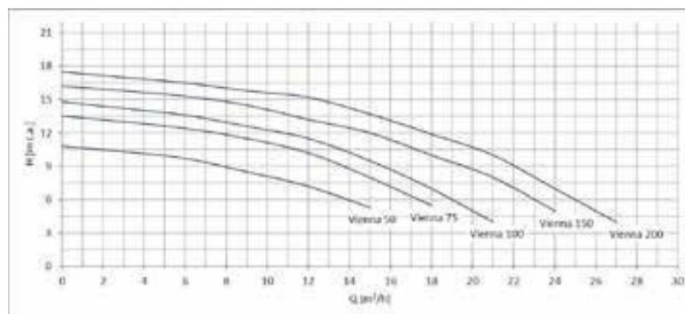
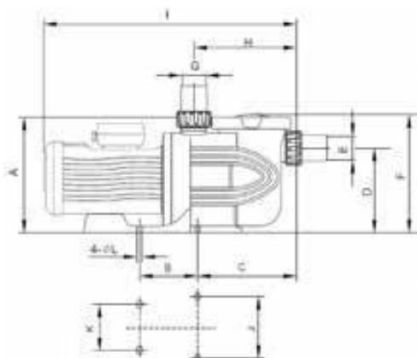

DIMENZIJE / DIMENSIONS

Model	A mm	B mm	C mm	D mm	E mm	F mm	G mm	H mm	I mm	J mm	K mm	L mm
Vienna 50	266	134	229	195	ø50/ø63	273	ø50/ø63	238	595	190	154	11,5
Vienna 75	266	134	229	195	ø50/ø63	273	ø50/ø63	238	595	190	154	11,5
Vienna 100	266	134	229	195	ø50	273	ø50	238	605	190	154	11,5
Vienna 150	266	134	229	195	ø50	273	ø50	238	605	190	154	11,5
Vienna 200	266	134	229	195	ø50	273	ø50	238	640	190	154	11,5

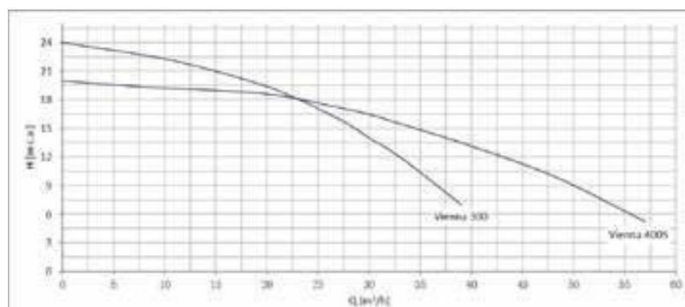
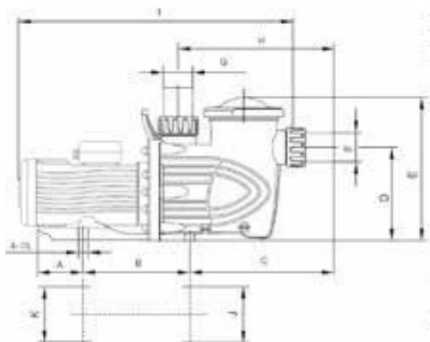

DIMENZIJE/ DIMENSIONS

Model	A mm	B mm	C mm	D mm	E mm	F mm	G mm	H mm	I mm	J mm	K mm	L mm
Vienna 300	113	267	348	232	358	ø75	ø75	379	656	168	166	11,5
Vienna 400S	113	267	348	232	358	ø75	ø75	379	708	168	166	11,5

HIDROMASAŽNE PUMPE

SERIJE ARCA 550-1500AZA HIDROMASAŽU
ARCA SERIES 550-1500A FOR HYDROMASSAGE



Arca 750



Arca 1100A-1500A

Centrifugalne pumpe sa dispozitivom za Dreenažu za hidromasažu

TELO

Usis i nosači odliva od polipropilena

- Vratilo motora od čelika inox AISI420
- Rotor od PPO
- Mehanička zaptivka od grafit i keram.
- Nosač zaptivke od stakla ili poliamida
- Aluminijumska obloga motora L-2521

MOTOR

- Asinhroni, dvopolni, 2850 obrtaja
- Zaštita IP55
- Izolacija klasa F
- Kontinuirani rad
- Termička zaštita integrisana u monofaznoj verziji

Single-stage centrifugal pump with drain BODY

- Suction and discharge mountings polypropylene.
- Motor shaft in stainless steel AISI-420.
- Impeller in PPO.
- Mechanical seal in graphite and ceramic
- Motor housing in aluminum L-2521.

- Asynchronous, two poles, 2800 rpm
- Protection IP55
- Insulation class F
- Continuous operation
- Thermal protection integrated in one phase version

Šifra monofaza	Šifra trofazni	Model	Snaga HP	Snaga kW	H m	Q m3/h	H m	Q m3/h	V 1~50HZ 3~50HZ	A 1~230 3~400	Cena monofaza	Cena trofazni
2220136	2220098	Arca 550	0,75	0,55	6	12,5	8	9,5	230 400	3,2 1,49	148,60 €	142,50 €
2220092	2220093	Arca 750	1	0,75	6	13,8	8	11	230 400	3,7 1,89	153,90 €	147,70 €
2220094	2220096	Arca 1100A	1,5	1,1	8	-	15	16	230 400	6,6 3,8	349,80 €	343,70 €
2220095	2220097	Arca 1500A	2	1,5	8	-	15	20	230 400	8,7 5	373,40 €	367,20 €

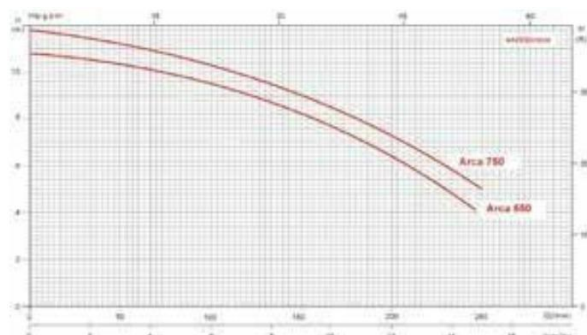
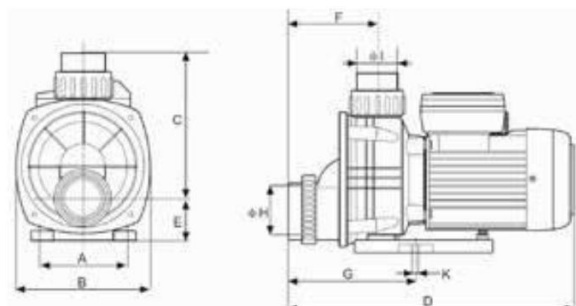

DIMENZIJE / DIMENSIONS - MODELLO ARCA 750

A mm	B mm	C mm	D mm	E mm	F mm	G mm	H mm	I mm	K mm	Peso kg
105	155	210	357	47	125	167	Ø50	Ø50	2-Ø9	4,4-6,5

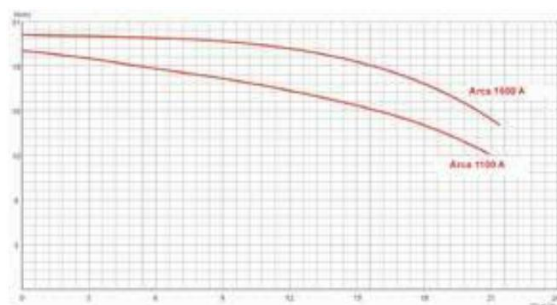
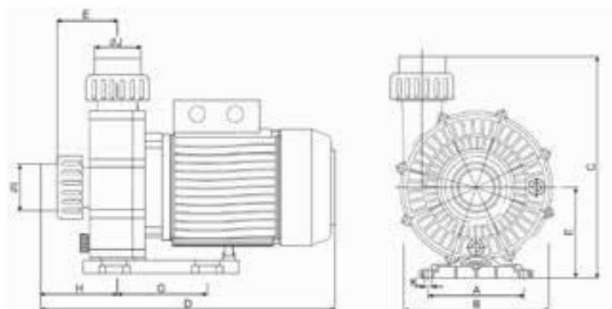

DIMENZIJE / DIMENSIONS - MODELLO ARCA 1100A - 1500A

A mm	B mm	C mm	D mm	E mm	F mm	G mm	H mm	I mm	J mm	K mm	Peso kg
124	186	277	380	111	78	120	95	Ø50	Ø50	4-Ø9	11-12

POMPE IDROMASSAGGIO HIDROMASAŽNE PUMPE

SERIJA ADRIA ZA PROTIVSTRUJNO PLIVANJE I HIDROMASAŽU SERIES ADRIA FOR COUNTERCURRENT SYSTEM AND HYDROMASSAGE



Adria New



Adria Mini

- Protok vode za protivstrujno plivanje. Centrifugalna pumpa visokog protoka, bez predfiltera
- Telo pumpe od polipropilena ojačan sa fiberglassom, otpornost na hemijske agente bazena
- Turbina od Noryl
- Vratilo motora od čelika inox AISI 316
- Zaštita IP55
- Verzije monofazne i trofazne
- Centrifugal pumps without prefilter for countercurrent system.
- Pump body in polypropylene reinforced with glass fiber, resistant to chemicals in the pool
- Turbine in Noryl
- Motor shaft in stainless steel AISI 316
- Protection IP55
- Version one phase and three phases

Šifra mono-fazni	Šifra trofazni	Model	Snaga HP	Snaga kW	H m	Q m ³ /h	H m	Q m ³ /h	V 1~50HZ 3~50HZ	A 1~230 3~400	Cena monofaza	Cena trofazni
1040037	1040038	Adria Mini 1,5 CV	1,5	1,1	6	34	8	27	230 400	6,6 3,8	653,10 €	629,50 €
1040046	1040047	Adria Mini 2 CV	2	1,5	6	42	8	36	230 400	8,7 5	752,40 €	728,70 €
1040048	1040049	Adria Mini 3 CV	3	2,2	6	45	8	43	230 400	14 4,8	814,10 €	790,40 €
1040027	1040028	Adria New 3CV	3	2,2	6	53	8	44	230 400	11 4	1.126,30 €	1.107,30 €
-	1040035	Adria New 4 CV	4	2,9	6	75	8	65	400	6,9	-	1.561,40 €
-	1040036	Adria New 5,5 CV	5,5	4	6	88	8	79	400	8,6	-	1.646,70 €

Adria New

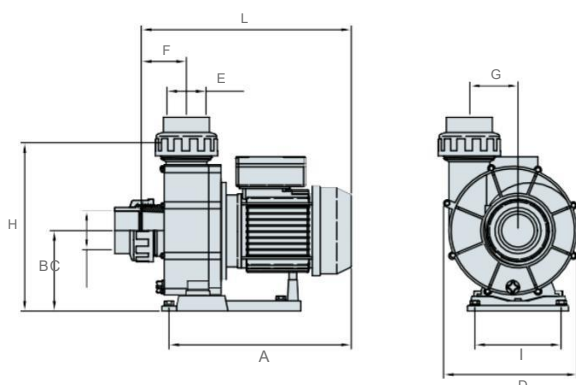

Adria Mini

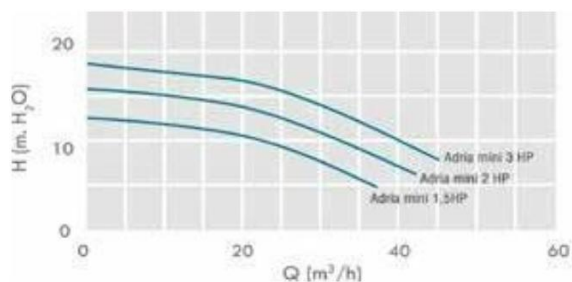
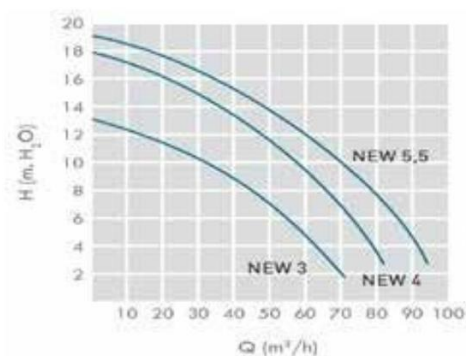
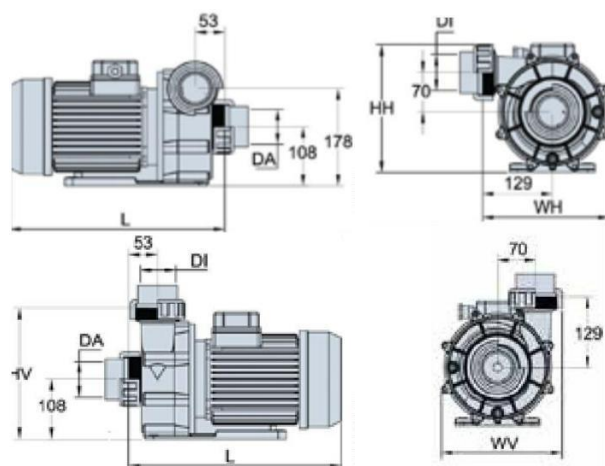

Model	A mm	B mm	C mm	D mm	E mm	F mm	H mm	I mm	L mm	težin kg	Model	L mm	WH mm	HV mm	WH mm	HH mm	DA mm	DI mm	Tež kg
New 3 CV	370	156	Ø75	260	Ø75	77	319	168	420	20,5	A. Mini 1,5 CV	350	225	237	235	228	Ø63	Ø63	15
New 4 CV	410	156	Ø75	260	Ø75	77	319	168	420	23,5	A. Mini 2 CV	365	225	237	235	228	Ø63	Ø63	16,5
New 5,5 CV	410	156	Ø75	260	Ø75	77	319	168	420	25,5	A. Mini 3 CV	385	225	237	235	228	Ø63	Ø63	19,5

HIDROMASAŽNE PUMPE ZA SPA / HYDROMASSAGE SPA SERIES

Specifične pumpe za hidromasažne kade i SPA

- Motor raspolaže ležajevima za visoke temperature za dugotrajnost i pouzdanost.
- Separacija za protok vode i osovine
- Zaštita IP55
- Izolacija klasa F
- Monofazna verzija

USLOVI RADA

- Srednja temperatura: 5-50°C
- Temperatura ambijenta: ≤ 40°C
- Max. Radni pritisak: 3bar

Specific pumps for hydromassage pool and SPA

- Motoris with high temperature bearings long operating lifewith reliability and durability
- Complete separation of water and the axis, safe and reliable.
- Protection IP55
- Insulation class F
- Version one phases

WORKING CONDITIONS

- Medium temperature: 5-50°C
- Environmental temperature: ≤ 40°C
- Max. working pressure: 3 bar

SERIJE WP300-II



Hidromasažna pumpa dvostruke brzine.
Double speed hydromassage pump.

Šifra	Model	Snaga		A 1~230	V 1~50 HZ	low speed		high speed		Cena
		HP	Kw			Hmax m	Qmax m3/h	Hmax m	Qmax m3/h	
600-01968	WP300-II	5/8	0,45 low speed	3	230	4	19,8	18	43,8	844,70 €
		3	2,2 HS high speed	10						

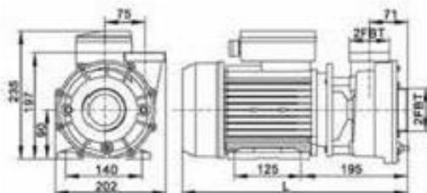

DIMENZIJE / DIMENSIONS

Model	L mm	ŠIRINA mm	VISINA mm	Ø ASP mm	Ø MAN mm	Teži na kg
WP300-II	431	202	235	63	63	18,5

**SERIJE ARCA 2200-3000 ZA PROTIVSTRUJNO PLIVANJE
ARCA SERIES 2200-3000 FOR COUNTER CURRENT SYSTEM**

Protok vode za protivstrujno plivanje.
Centrifugalna pumpa visokog protoka



TELO

- telo pumpe, baza i difuzor od polipropilena
- Rotor u Noryl
- Nosač zaptivke od stakla ili poliamida
- Čelično vratilo inox AISI 420
- Mehanična zaptivka od grafita ili steatita
- Aluminijumska obloga motora L-2521
- Namotaji impregnisani u episodičnoj smoli

MOTOR

- Asihron, dvopolni, 2800 obrtaja
- Zaštita IP55
- Izolacija klasa F
- Kontinuirani rad
- Monofazne i trofazne verzije
- Termička zaštita integrisana u monofaznu verziju.

Centrifugal pump without prefilter for counter current system.

BODY

- pump body, base, diffuser in polypropylene
- impeller in Noryl
- support sealing glass and polyamide
- motor shaft in stainless steel AISI 420
- Mechanical seal in graphite and steatite
- Motor housing in aluminum L-2521
- Windings impregnated with epoxy-resin

ENGINE

- Asynchronous, two poles, 2800 rpm
- Protection IP55
- Insulation class F
- Continuous operation
- Version one and three phases
- Thermal protection integrated in one-phase version

Šifra monofaze	Šifra trofazna	Model	Snaga HP	Snaga kW	H m	Q m3/h	H m	Q m3/h	V 1~50HZ 3~50HZ	A 1~230 3~400	Cena monofaz.	Cena trofaz.
2220089	2220090	Arca 2200	3	2,2	6	56	8	50	230 400	15 4,9	803,60 €	762,90 €
-	2220091	Arca 3000	4	3	6	79	8	64	- 400	- 6,4	-	809,70 €

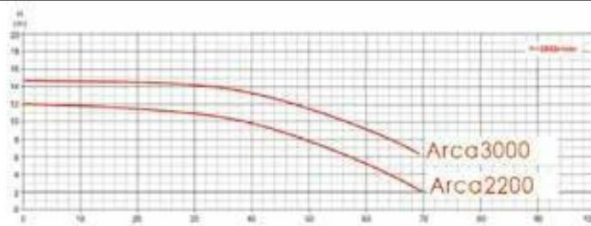
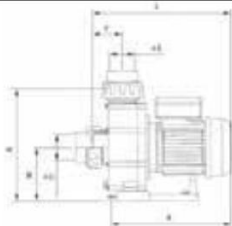

DIMENZIJE / DIMENSIONS

Model	A mm	B mm	C mm	D mm	E mm	F mm	G mm	H mm	I mm	L mm
Arca 2200	370	156	Ø75	260	Ø75	77	95	319	168/117	420
Arca 3000	410	156	Ø75	260	Ø75	77	95	319	168/117	450

PROTIVSTRUJNO PLIVANJE ANGEL RIVER E GULFSTREAM OD INOX ČELIKA

PROTIVSTRUJNO PLIVANJE ANG

Sa piezo električnim prekidačem sa napajanjem 12/24 V CC

Equipped with electric piezo button with 12/24 V DC power supply



/ STA



ER CUR



Šifra /code	Opis /description	Cena/price
1073011	Inox mlaznica 316, fino a 67 m3/h, spojka2"1/2M Nozzle inox 316, up to 67 m3/h, connection2"1/2M	3.672,00 €

Šifra monofase	Šifra trifase	Opis /description	Cena monofase	Cena trifase
1073021	1073027	Protiv strujno plivanje Angel Inox kompletno, 54 m3/h, sa pumpom ARCA 2200, Elektro tablom, spojnice i cevi/ Complete counter current Angel 1 jet 54 m3/h, with pump ARCA 2200, electric panel, fitting and tubes	5.536,00€	5.726,00 €

PROTIVSTRUJNO PLIVANJE – DUPLI MLAZ / STAINLESS STEEL COUNTER CURRENT SYSTEM ANGEL - DOUBLE JET

Sa piezo električnim prekidačem 12/24 V CC sa napajanjem

Equipped with electric piezo button with 12/24 V DC power supply

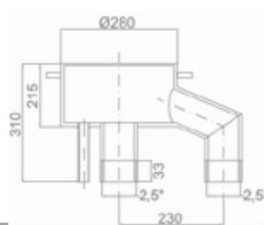
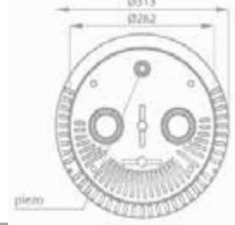

Šifra/code	Opis /description	Cena/price
1073022	Inox mlaznica 316, fino a 75 m3/h, spoj 2"1/2M Nozzle inox 316, up to 75 m3/h, connection2"1/2M	5.405,30 €

Šifra trifase	Opis/description	Cena trifase
1073028	Protivstrujno plivanje Angel inox kompletno, 75 m3/h, sa pumpom ARCA 3000, elektro tablom, spojnice i cevi/ Complete counter current Angel 1 jet 75 m3/h, with pump ARCA 3000, electric panel, fitting and tubes	7.815,00 €

PROTIVSTRUJNO PLIVANJE RIVER / STAINLESS STEEL COUNTER CURRENT SYSTEM RIVER

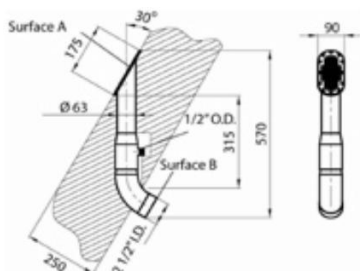

ŠIFRA / code	Opis /description	/Cena price
1073023	Mlaznica Riverspora rekainox, protok max 20-45 m3/h / TorrentRiverjet, maxflow20-45m3/h	1.006,40 €

PROTIVSTRUJNO PLIVANJE GULFSTREAM / STAINLESS STEEL COUNTER CURRENT SYSTEM GULFSTREAM

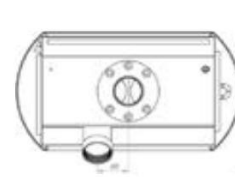
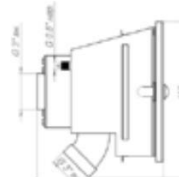
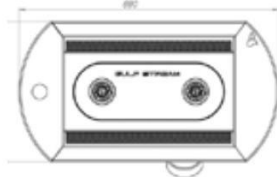

Šifra /code	Opis /description	Cena/price
1073024	MlaznicainoxGulfStream,85m3/h,sa pneumatskim prekidačem InletinoxGulfStream, 85 m3/h, withpneumatic switch	4.170,80 €

PROTIVSTRUJNO PLIVANJE

**PROTIVSTRUJNO PLIVANJE BADUJET WAVE
COUNTER CURRENT SYSTEM WAVE**



Badujet wave sa ručkom



Badujet wave

Za montažno uklapanje u zid za sve bazene. Kao atrakcija, za fitness, kao i kiseoničku kupku i podvodno masiranje. Za jednu prijatnu atmosferu aparat poseduje reflektor LED sa jednom bojom ili RGB menjač boja, koji se akcionira lako jednim prekidačem kao i regulisanje smeše vazduha za jednu kipeću masažu. Velika ručka od inox čelika. Bez veznih i ventila. DEO ZA ZIDANJE

Plastično telo za uzidivanje kompletiran sa PVC spojnicama Ø63/75, kompletno regulisanje vazduha, matice i dihtunzi za PVC oblogu sa šrafovim.

FINIŠIRANI DEO

Telo mlaznice kompletno sa šrafovim (sa usmerivom i podesivom mlaznicom), kompletan ram, kompletna komadna tabla IPX5, pumpa Speck Badu 21 sa spojnicama.

MATERIJALI

Ram ABS

Telo za uzidivanje ABS

Telo mlaznice ABS

Unutarnji delovi ABS/čelik inox

For wall installation in all pools. As attraction, for fitness, as oxygenating bath and a massage underwater. For a pleasant atmosphere it is equipped with LED light single color or RGB color changing, is easily activated with a button as also the air control for an effervescent massage. Stainless steel handle. Connection pipes and valves excluded.

PART TO WALL

Plastic body to wall complete with PVC fittings d.63/75, complete air regulation, ring and gaskets for PVC coating with screws.

FINISHING PART

Nozzle Body complete with screws (with pivoting and adjustable nozzle), complete frame, complete control panel IPX5, Speck Badu 21 pump with fittings

MATERIALS

ABS frame

ABS body to wall

ABS nozzle Body

ABS/stainless steel inner parts

Šifra/code	opis/description	Cena/price
1040185	Uzidni deo Badujet Wave - Smart / Part to wall Badujet Wave - Smart	772,50 €
1040181	Finiš monofaza 54 m3/h led belo sa pumpom 2,2 kW e quadroelettrico/ Finishing part monophase 54 m3/h white led with pump 2,2 kW and electrical panel	6.480,40 €
1040182	Finiš monofaze 54 m3/h led multicolor sa pumpom 2,2 kW e quadro elettrico / Finishing part monophase 54 m3/h multicolor led with pump 2,2 kW and electrical panel	6.842,20 €
1040186	Finiš trofazni 58 m3/h led belo sa pumpom 2,6 kW i električna tabla/ Finishing part threephase 58 m3/h white led with pump 2,6 kW and electrical panel	5.555,60 €
1040187	Finiš trofazni 58 m3/h led multicolor sa pumpom 2,6 kW e quadroelettrico/ Finishing part threephase 58 m3/h multicolor led with pump 2,6 kW and electrical panel	6.842,20 €
1040183	Čelična ručka inox AISI316/ Stainless steel AISI316 handl	1.642,90 €

**PROTIVSTRUJNO PLIVANJE BADUJET SMART
COUNTER CURRENT SYSTEM SMART**

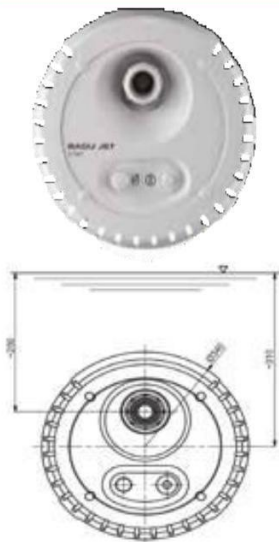

Ugradna montaža u zid u sve bazene. Kao atrakcija, za fitness, kao i kiseonička kupka i za podvodnu masažu. Pneumatski prekidač on/off i regulisanje ubacivanje vazduha, koji daje efekat penušavih mehurića, oba su integrisana u sklop mlaznice.

Bez povezanih cevi i ventila.

DEO ZA UZIDIVANJE

Plastično telo za uzidivanje, matica i dihtunzi za PVC oblogu sa šrafovim.

FINIŠIRANI DEO

Telo mlaznice u kompletu sa šrafovim (sa usmerivom mlaznicom), komadna tabla, pumpa Speck Badu 21 sa spojnicama

MATERIJALI

Telo za uzidivanje

ABS

Telo mlaznice ABS

Unutarnji delovi ABS / čelik inox

For wall installation in all pools. As attraction, for fitness, as oxygenating bath and a massage underwater.

The pneumatic on/off switch and the regulation for the air intake, which gives the sparkling bubble bath effect, are both integrated in the nozzle housing.

Connection pipes and valves excluded

PART TO WALL

Plastic body to wall clamping ring and gaskets for PVC coating with screws.

FINISHING PART

Nozzle body complete with screws (with swivelling nozzle), control panel, Speck Badu 21 pump with fittings

MATERIALS

ABS body to wall

ABS nozzle body

ABS / stainless steel inner parts

Šifra /code	Opis /description	Cena/price
1040185	Uzidni deo Badujet Wave - Smart / Part to wall Badujet Wave - Smart	772,50 €
1040198	Monofazni finiš 40 m3/h sa pumpom 1,6 kW i elektro tablom Finishing part monophase 40 m3/h with pump 1,6 kW and electrical panel	4.250,00 €
1040171	Trofazni finiš 45 m3/h sa pumpom 1,6 kW i elektro tablom Finishing part threephase 45 m3/h with pump 1,6 kW and electrical panel	4.250,00 €

**PROTIVSTRUJNO PLIVANJE SET NIAGARA
COUNTERCURRENTSYSTEMKITNIAGARA**



SET MLAZNICA PROTIVSTRUJNO PLIVANJE NIAGARA SASTOJI SE OD

THE KIT COUNTER-CURRENT NIAGARA CONSISTS OF:

- Mlaznice za protivstrujno plivanje NIAGARA
- the returnfitting counter-current NIAGARA



SET PUMPE I OPREME ZA PROTIVSTRUJNO PLIVANJE SASTOJI SE OD:

THE KIT WITH PUMP AND ACCESSORIES SWIM COUNTER THE CURRENT NIAGARA CONSISTS OF:

- Pumpa za protivstrujno plivanjeARCA 2200
- Tabla sa pneumatskim konvertorom
- Tvrda PVC cev Ø63
- Reduktori, kolena Ø63 za spajanje i lepak
- Lokal SPA za smeštaj od smole (gde predviđen)
- the pump ARCA2200
- tThe control panel with pneumatic transducer
- the rigid PVC pipe Ø63
- the reductions, elbows fitting Ø63 and glue
- the localresinSPAhousing(where expected)

Šifra /code	Opis /description	Cena/price
1040057	Set mlaznice protivstrujno plivanje NIAGARA kit Niagara with return fitting counter current	576,30 €
1040054	Set mlaznice protivstrujno plivanje NIAGARADouble JET kitDouble Jet Niagarawith returnfittingcounter cur	419,90 €
1040055	Set mlaznice za protivstrujno plivanje NIAGARA LED kit Niagara Led with return fitting	806,80 €
1040056	Set mlaznice za protivstrujno plivanje NIAGARAINOX 316 kitNiagaraInox316withreturnfittingcounter	1.082,60 €

Šifra monofaza	Šifra trof.	Opis /description	Cena monofaza	Cena trof.
1040058	1040094	Set NIAGARA / BALNEO pumpa i oprema (uzidan lokal) / masonry housing	1.439,00 €	1.382,00 €
1040093	1040095	SetNIAGARApumpa i oprema completan Spa lokal od smole / SPA technical housing	2.204,00 €	2.154,00 €



cod.1040056



cod.1040055



cod.1040054

Šifra monofase	Šifra trifase	Opis /description	Cena monofase	Cena trifase
Komplet Set NIAGARA (Set mlaznica+ set pumpa) / NIAGARA COMPLETE KIT (return fitting kit + pump and accessories kit)				
1040100	1040101	Komplet set NIAGARA (uzidani lokal) / masonry housing	2.016,00 €	1.958,00 €
1040102	1040103	Komplet set NIAGARA (lokal SPA od smole) / SPA technical housing	2.780,00 €	2.730,00 €
KOMPLET SET NIAGARA DOUBLE JET (set mlaznica + set pumpa) / NIAGARA DOUBLE JET COMPLETEKIT (returnfittingkit+pumpandaccessorieskit)				
1040104	1040105	Komplet set NIAGARA DOUBLE JET (uzidani lokal) / masonry housing	1.859,00 €	1.801,00 €
1040106	1040107	Komplet set NIAGARA DOUBLE JET (locale SPA od smole) / SPA technical housing	2.624,00 €	2.573,00 €
KOMPLET SET NIAGARA LED (set mlaznica + set pumpa) / NIAGARA LED COMPLETE KIT				
1040108	1040109	Komplet set NIAGARALED(uzidani lokal)/masonryhousing	2.245,00 €	2.188,00 €
1040110	1040114	Set kompletan NIAGARA LED (lokal SPA od smole) / SPA technical housing	3.010,00 €	2.960,00 €
Komplet set NIAGARA INOX 316 (set mlaznica+set pumpa) /NIAGARA INOX 316 COM- PLETEKIT (returnfittingkit+pumpandaccessorieskit)				
1040115	1040116	Set kompletan NIAGARA INOX 316 (locale in muratura) / masonry housing	2.521,00 €	2.464,00 €
1040117	1040118	Set kompletan NIAGARA INOX 316 (locale SPA in resina) / SPA technical housing	3.286,00 €	3.236,00 €

**PROTIVSTRUJNO PLIVANJE SET BELLOW
JET COUNTER CURRENT SYSTEM KIT BELLOW
JET**



***PRODOTTOCORRELATO: POMPE PER
NUOTO CONTRO CORRENTE**
** PRODUCT: PUMPS FOR COUNTER
CURRENT SYSTEM*

SET MLAZNICA BELLOW-JET U SASTAVU:

THE KIT RETURN FITTING FOR RESISTANCE BELLOW-JET CONSISTS OF:

- Mlaznica za protivstrujno plivanje
- Pneumatski prekidač
- Mlaznica za kontrolu vazduha
- Usisna mlaznica
- Cev PVC tvrdi Ø63
- Navojni spoj Ø63
- Mrežasto crevo za povezivanje
- The upstreamnozzle
- The pneumaticbutton
- The air control nozzle
- The inletnozzle
- The rigid PVC pipe Ø63
- the connection sleeveØ63
- The connection wiredtube

SET PUMPA I SPOJNICE BELLOW-JET U SASTAVU:

THE KIT PUMP AND FITTINGS FOR BELLOW-JET CONSISTS OF:

- Pumpa za protivstrujno plivanje ARCA2200
- Komadna tabla sa pneumatskim konvertorom
- Cev PVC tvrdi Ø63
- Reduktori, kolenai kuglični ventili Ø63 za spojeve i lepak
- Il locale SPA od smole za smeštaj (samo za modele 1040091 e 1040092)
- Thepumpswimmingcounter the current ARCA 2200
- The control panel with pneumatic transducer
- The rigid PVC pipe Ø63
- The reductions, elbows and ball valves Ø63 connectors and glue
- the local PPS resin housing (only for models 1040091 and 1040092)

Šifra /code	Opis /description	Cena/price
1070252	Usisna mlaznica 2" ½ - 63- 162mm / suction nozzle 2" ½ - 162 mm	73,00 €
1070253	Pneumatski protivstrujni prekidač / pneumatic button cunter current	69,30 €
1070254	Mlaznica za kontrolu protivstrujnog vazduha / air regulator cunter current	78,50 €
KIT BELLOW-JET / KIT BELLOW JET		

1070251	Kit Mlaznica za protivstrujno plivanje BELLOW-JET KitreturnfittingforcountercurrentsystemBELLOW-JET	483,20 €
---------	--	----------

Šifra monofase	Šifra trifase	Opis /description	Cena monofase	Cena trifase
1040053	1040090	Set BELLOW-JET pumpa 3HP, fitting i ventili (uzidani lokal) Bellow-jet kit with 3HP pump, fittings and valves (masonry housing)	1.464,00 €	1.411,00 €
1040091	1040092	Kset BELLOW-JETpumpa3HP,fitingi ventilikomplentnosalokalomSPA od smole Bellow-jet kit with 3HP pump, fittings and valves with SPA technical housing	2.212,00 €	2.154,00 €

KOMPLETAN SET BELLOW-JET (SET MLAZNICA + set pumpa) / KOMPLET SET				
1040096	1040098	Komplet set BELLOW-JET (zidani lokal) / masonry housing	1.966,00 €	1.909,00 €
1040097	1040099	Komplet set BELLOW-JET (lokaleSPA od smole) / SPA technical housing	2.823,00 €	2.739,00 €

ŠEMA TIPSKA UREĐAJA UZIDANOG ZA HIDROMASAŽU
SYSTEM HYDROMASSAGEMASONRY

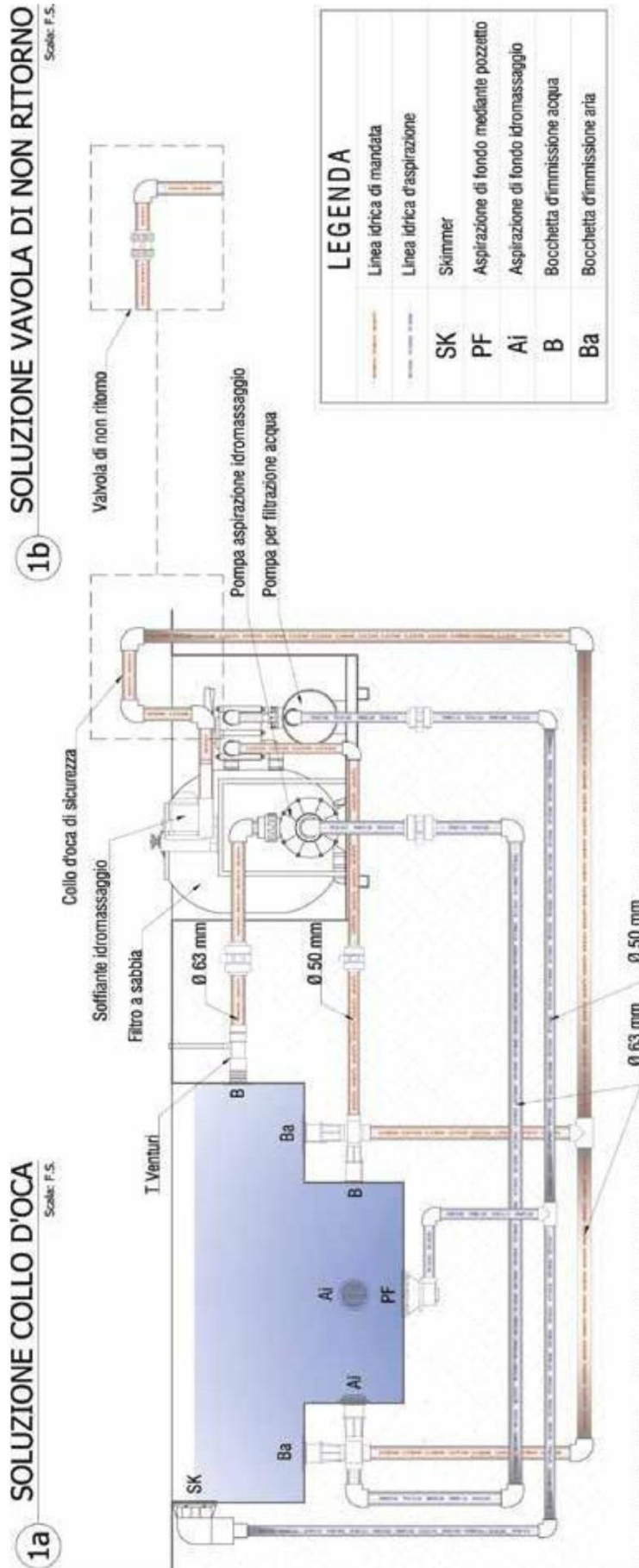

**KOMPRESOR SA NAIZMENIČNIM RADOM ZA UZIDANE SPA
FOR MASONRY SPA BLOWERS IN ALTERNATING OPERATION**



BLOWER sa naizmenicnim radom



cod.1070477



cod.1070476

Šifra / code	Opis /description	Cena/ price
KOMPRESORI SA NAIZMENIČNIM RADOM/ Blowers in alternating operation		
1070588	Blowerkompresor900Watt230 Volt blower 900 watt 230 Volt	459,80 €
1070587	Blowerkompresor 1200 Watt 230Volt blower 1200 Watt 230 Volt	488,30 €
OPREMA ZA BLOWERS / ACCESSORIES FOR BLOWER		
1070476	Poluspojna čaura Ø32 mm 328P22 union sleeve with half coupling Ø32 mm	2,30€
1070477	Poluspojna navojna matica328P23 threaded union ring with half coupling	5,10€

**ALUMINIJUMSKI KOMPRESOR – NEPREKIDNI RAD
ALUMINUM BLOWERS - CONTINUOUS OPERATION**



Aluminijumski kompresor sa neprekidnim radom imaju u sastavu:

- Kompresor od aluminijumske legure
- Prigušivač pri usisu
- Prigušivač pri izduvavanju

Thealuminumblowercontinuous operation include:

- aluminum alloyBlower
- suction silencer
- outlet silencer



Šifra / code	Model/model	Snaga/ power kW	Absorbcija A	Priključci	Cena/ price
1070583	Monofazni aluminijumski kompresor	0,7	4,8	1"¼	680,00 €
1070584	Trofazni aluminijumski kompresor	0,7	2,2	1"¼	680,00 €
1070595	Monofazni aluminijumski kompresor	0,8	5,7	1"½	650,50 €
1070596	Trofazni aluminijumski kompresor	0,9	2,4	1"½	640,60 €
1070590	Monofazni aluminijumski kompresor	1,5	10,1	2"	1.043,40 €
1070591	Trofazni aluminijumski kompresor	1,5	5,1	2"	911,30 €
1070594	Trofazni aluminijumski kompresor	2,2	6,1	2"	1.367,90 €

OPREMA ZA KOMPRESORE OD ALUMINIJUMA-USISNI FILTERI, PRIGUŠIVAČI



Filtro in aspirazione
Suction filtre

Šifra /code	Opis/description	Cena/price
USISNI FILTER/ suction filters		
1070598	Uisinski filter Ø1"¼ / suction filters Ø1"¼	140,00 €
1070600	Uisinski filter Ø1"½ / suction filters Ø1"½	198,10 €
1070601	Uisinski filter Ø2" / suction filters Ø2"	224,60 €

**ACCESSORI PER BLOWERS IN ALLUMINIO - FILTRI IN ASPIRAZIONE, SILENZIATORI
ACCESSORIES FOR ALUMINUM BLOWERS - SUCTION FILTERS, SILENCERS**



Silenziatore
Silencer

PRIGUŠIVAČI / SILENCERS		
1070607	Prigušivač Ø1"¼ / silencers Ø1"¼	100,00 €
1070605	Prigušivač Ø1"½ / silencers Ø1"½	139,70 €
1070606	Prigušivač Ø2" / silencers Ø2"	151,90 €

*POVEZANI PROIZVOD: HIDROMASAŽNE PUMPE OD STR. 133
*PRODACT: PUMPS FOR HYDRO P 133

HIDROMASAŽA

ACQUABUBBLE OKRUGLI
ROUND WATERBUBBLE

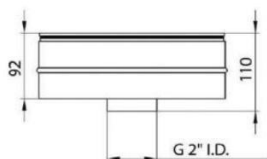
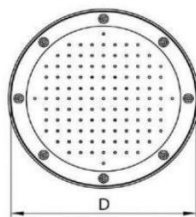

Uređaj za vazdušnu hidromasažu od inox čelika304.

Device for hydromassage with air made of stainless steel304.

Šifra /code	Opis /description	D [mm]	Protok [m3/h]	Cena/price
1073009	AcquaBubble Ø 310 – donji priključak 2" F per liner - čelik inox 304 Acqua BubbleØ310-lowerconnection2"Fforliner-stainlessteel304	310	50	862,40 €
1073010	AcquaBubble Ø 420 – donji priključak 2" F za liner - čelik inox 304 Acqua BubbleØ420-lowerconnection2"Fforliner-stainlessteel304	420	50	1.369,20 €

ACQUA BUBBLE ČETVRTAST
SQUARE WATER BUBBLE

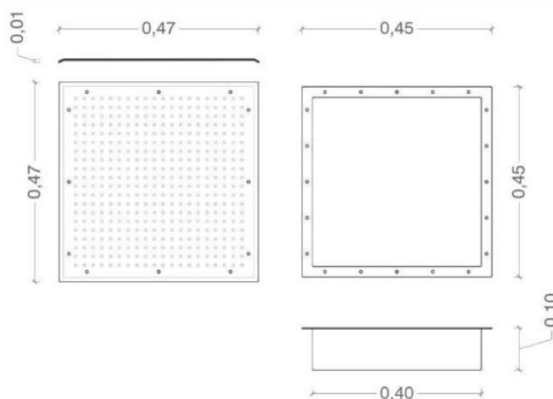
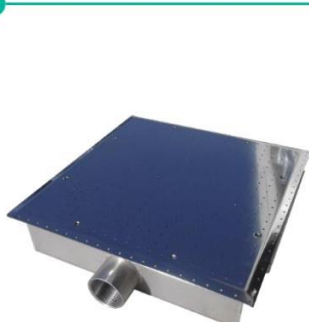

Uređaj za vazdušnu hidromasažu od čelika inoxAISI316 snabdeven internim dispozitivom za regulisanje protoka vazduha.

Device for hydromassage with air made of stainless steel AISI 316 and purposeoftheinternalcontrolairflow.

Šifra /code	Opis /description	Cena/price
1041225	ACQUA BUBBLE 400x400 – priključak 2" za liner - čelik inox AISI 316 WATER BUBBLE 400x400 - priključak 2" za liner - stainless steel AISI 316	1.190,00 €

SET HIDROMASAŽNI ACQUA BUBBLE
KIT WATER BUBBLE

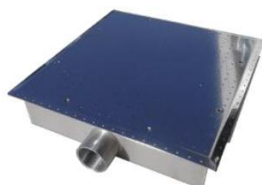

SET U SASTAVU:

THE KIT CONSISTS OF:

- Acquabubble400x400trofazni za liner
- Kompresor od 0,90 kW Sa kontinuiranim radom
- Povezni fitting prečnika 63
- Lepak za fitting
- Tubo PVC rigido diametro 63
- Water bubble 400x400 threephase for liner
- The blower from 0.90 kW
- The connection pipes diameter 63
- The glue for the fittings
- Rigid PVC pipe diameter 63

Šifra /code	Opis /description	Cena/price
1030177	KitAcquabubble400x400perliner Kit water bubble for liner	2.296,00 €

SET MLAZNICA ZA HIDROMASAŽU SLIMLINE ARIA/ACQUA ZA PLOČICE / MOSAICO
KIT HYDROMASSAGE JETS SLIMLINE FOR TILES POOLS



cod. 1070

Šifra /code	Opis /description	Cena/price
1070424	MlazSlimlinevazduh/vodaØ32sa mlaznicom fiso Jet slimliner air/water with fixed nozzle	37,90 €
1070431	MlazSlimlinevazduh/voda Ø32/50 samlaznicom fiso Jetslimlinerair/waterØ32/50withfixed	82,80 €

SET HIDROMASAŽNIH MLAZNICA SERIE HIDDEN PER LINER

Le bocchette idromassaggio in KIT serie HIDDEN sono ideali nell'installazione in impianti pubblici o realizzazioni dove si voglia proteggere la bocchetta e la sua regolazione. Per installare e rimuovere le bocchette serie HIDDEN é necessaria l'apposita chiave a corredo 1070615



Šifra / code	Opis /description	Cena / price
1070619	Set mlaznica HIDDEN podesivi mlaz / return fitting kit adjustable jet	60,60 €
1070620	Set mlaznica HIDDEN promenljiv mlaz / return fitting kit variable jet	60,90 €
1070621	Set mlaznica HIDDEN hidromasažni mlaz / return fitting kit massage jet	61,80 €
OPREMA ZA DOPUNU SERIEHIDDEN/HIDENSERIEACCESSORIES		
1070615	Ključ za instalaciju mlaznica HIDDEN218-1770A/KeytoinstalljetsHIDDEN	9,60 €



cod. 1070619



cod. 1070620



cod. 1070621

SET HIDROMASAŽNIH MLAZNICA SERIE JET PER LINER JET SERIE RETURN FITTING KIT FOR LINER



cod. 1070548



cod. 1070549



cod. 1070540

Šifra /code	Opis /description	Cena /price
1070548	Set mlaznica JET kružni mlaz / return fitting kit with rotary jet	80,10 €
1070549	Set mlaznica JET podesivi mlaz / return fitting kit directional jet	81,50 €
1070540	Set mlaznica JET pulsirajućeg mlaza / return fitting kit pulsator jet	89,10 €

SET HIDROMASAŽNIH PROMENLJIVOG SMERA MLAZNICA SERIE JET ZA PLOČICE / MOZAIK

Set mlaznica promenljivog smera su idealne za skrivenu instalaciju gde je potrebno premostiti rastojanje veće od tradicionalnih 20-25 cm. Set dozvoljava po želji da se produže rastojanja između tela i mlaznice, rezanjem po meri komada cevi od tvrdog PVC preč.75 i 32.

Kompletan set u sastavu :

- Set telo i delovi za instalaciju
- Kućište nosača mlaznice
- mlaznica JET (model po izboru)

Thekitsvariable jetsare ideal for installation under plaster where it is necessary to cross distances over traditional 20-25 cm. of masonry. The kit allows to extend as desired the distance between the body and the jet, by cutting logs of rigid PVC pipes diam. 75 and 32. The complete kit is composed by :

- installation kit body and accessories
- jet niche
- Return fitting jet (model choice)



cod.1070650



cod.1070651



cod. 1070652

Šifra /code	Opis /description	Cena /price
1070650	Set mlaznica promenljivog smerakružni mlaz/returnfittingkitwithrotaryjet	89,90€
1070651	Set mlaznica promenljivog smera podesivog mlaza/returnfittingkitdirectionaljet	98,00€
1070652	Set mlaznica promenljivog smera pulsirajućeg mlaza/returnfittingkitpulsatorjet	98,00€

MLAZNICE ZA HIDROMASAŽU RETURN FITTING HYDROMASSAGE



Šifra / code	Opis /description	Cena/ price
POTISNE VAZDUŠNE MLAZNICE / AIRRETURN FITTING		
1071056	Zidna mlaznica od 2" per liner INOX AISI 316 / 2" return fitting for liner INOX AISI 316	333,00 €
1071057	Mini mlaznica INOX AISI 316 da 1/2" / small, 1/2" mini-return fitting INOX AISI 316	72,60 €
1071070	Mini mlaznica INOX AISI 316 da 1" / small, 1" mini-return fitting INOX AISI 316	115,50 €
1070870	Mini mlaznica sa telom ABS I hromiranom glavom izlaza 3/8" / small ABS body and chrome head	14,50 €
1070494	Mini glava ø38 mm sa telom ABS I hromiranom glavom / small ABS body and chrome head	8,30 €
1070880	Adapter ø25 mm za mini vazдушnu mlaznicu cod. 1070494 / Ø 25mm Adapter for cod. 1070494	9,20 €
POTISNE VAZDUŠNE MLAZNICE - INOX AISI 304 / AIR RETURN FITTING - STAINLESS STEEL AISI 304		
1071065	Masirajući vazdušni mlaz 3/4" za bazene sa lajnerom / Air massage jet 3/4" for liner pools	138,80 €
1071074	Masirajući vazdušni mlaz 1/2" za liner, protok 1m3/h/ Air massage jet 1/2" for liner, flow 1m3/h	113,20 €
1071073	Masirajući vazdušni mlaz za pločice 1/2", protok 1m3/h/ Air massage jet 1/2" for tiles, flow 1m3/h	58,80 €
HIDROMASAŽNE MLAZNICE - INOX AISI 304 / HYDROMASSAGE JETS - STAINLESS STEEL AISI 304		
1071075	Hidromasažni mlaz 1x29, protok 45 m3/h / hydromassage jet 1x29, flow 45 3m	1.053,60 €
1071087	Hidromasažni mlaz 16 rupa, protok 45 m3/h / hydromassage jet 16 nozzles, flow 45 3m	1.198,40 €
1071088	Hidromasažni mlaz sa rešetkom protok 45 m3/h / Soft top hydromassage jet flow 45 3m	1.104,80 €

DUGMAD INOX PUSH BUTTON IN STAINLESS STEEL

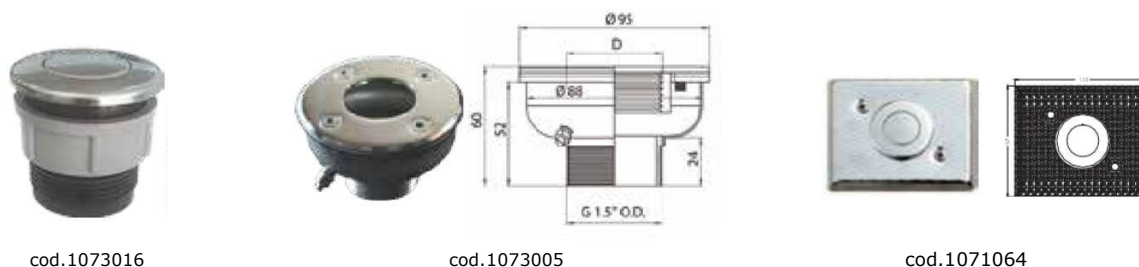

Šifra / code	Opis /description	Cena/ price
1073016	Pneumatski prekidač sa poklopcem – samo sa svojim adapterom/ Pneumatic switch with lid - only with its adapter	38,40 €
1073005	Nosač pneumatskog prekidača za liner 1 1/2" M-INOX AISI 304 / Supporter for pneumatic button for liner 1 1/2" M - stainless steel AISI 304	136,40 €
1071064	Prekidač inox 316 sa 1 prekidačem / 316 stainless steel button panel with 1 button	263,50 €

PNEUMATSKE KOMANDE I ELEKTRIČNI PIEZO / PNEUMATIC COMAND AND PIEZO ELECTRICAL



cod.1055084



cod.1055088



cod.1055085



cod. 1040085



Comandi elettrici



cod.1070604



cod.1070603



cod. 1070473



cod. 1070611

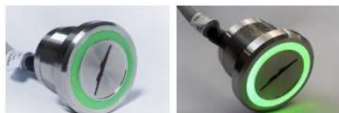

cod. 1070610



cod.1070656



cod. 1070657

Šifra/ code	OPIS /description	Cena/ price
PNEUMATSKE KOMANDE / PNEUMATIC COMMANDS		
1055084	Pneumatski prekidač Ø45.7 in ABS belo / white pneumatic in ABS	27,80 €
1055088	Pneumatski prekidač Ø45.7 in ABS hromiran / chrome pneumatic in ABS	46,80 €
1055085	Pneumatski prekidač istureni in ABS belo / white raised pneumatic in ABS	29,30 €
1055087	Pneumatski prekidač istureni in ABS hromirani / chrome raised pneumatic in ABS	54,60 €
1040085	Prekidač MAXI vodootporan za armirani beton / maxi button for concrete	59,90 €
1040086	Prekidač MAXI vodootporan za liner / maxi button for liner	118,30 €
KOMANDE PIEZOELEKTRIČNI(vodootpornido 1m)/PIEZOELECTRICALSWITCHS(waterresistant1m)		
1070611	Prekidačpiezoelektrični inox316L,200mA,a6-24VAC/DC/piezoelectricalsteelbutton,SS316L,6-24VAC/DC	73,20 €
1070610	Prekidač piezo električni inox 316L, 200mA, a 6-24VAC/DC, pozadinska rasveta Led zeleni	145,60 €
1070656	Piezo električni steel button, SS 316L, 6-24 VAC/DC, green back-lit LED	145,60 €
1070657	Prekidač piezo električni inox 316L, 200mA, a 6-24VAC/DC, pozadinska rasveta Led crveno	145,60 €
COMANDI ELETTRICI / ELECTRICAL SWITCHS		
1070612	Pulsanteelettricoinoxa3-6V,conanello difissaggio,aretroilluminazioneLedBluconsimbolo perdispositivoLUCE	91,20 €
1070613	Pulsanteelettricoinoxa3-6V,conanello difissaggio,aretroilluminazioneLedBluconsimbolo perdispositivoARIA	91,20 €
1070614	Pulsanteelettricoinoxa3-6V,conanello difissaggio,aretroilluminazioneLedBluconsimbolo perdispositivoAC-QUA / Electrical steel button to 3-6 V, with clamping ring, back-lit LED blue with symbol for device WATER	90,40 €
KOMADNE ELEKTRIČNE PLOČE / ELECTRICAL SWITCHS		
1070604	Prekidač Ø64 1 funkcija / control Ø64 for one equipment	215,60 €
1070603	Prekidač Ø64 2 funzioni pompa e soffiante / control Ø64 for 2 equipments, pump and blower	196,30 €
1070473	Prekidač Ø64 3 funzioni pompa, soffiante e luce /control for 3 equipments, pump, blower and light	208,00 €
1070602	Električne kartice kontrolne ploče 2 funkcije / electric board control plate control plate 2 functions	240,40 €

OPREMA/EQUIPMENT

CEVI ZA PNEUMATSKE KOMANDE / HOSES FOR PNEUMATIC COMMANDS



cod. 1070524

Šifra / code	Opis /description	Cena po m/price by m
1070513	Providna cev od savitljivog PVC Ø 2 mm iznutra x Ø 4 mm spolja PVC flexible transparent hose Ø 2 mm internal, Ø 4 mm external	1,60 €
1070524	Providna cev od savitljivog PVC Ø 3 mm iznutra x Ø 5 mm spolja PVC flexible transparent hose Ø 3 mm internal, Ø 5 mm external	2,00 €
1070511	Providna cev od savitljivog PVC Ø 4 mm iznutra x Ø 6 mm spolja PVC flexible transparent hose Ø 4 mm internal, Ø 6 mm external	2,40 €
1070514	Providna cev od savitljivog PVC Ø 5 mm iznutra x Ø 8 mm spolja PVC flexible transparent hose Ø 5 mm internal, Ø 8 mm external	3,00 €
1070512	Providna cev od savitljivog PVC Ø 8 mm interno x Ø 12 mm esterno PVC flexible transparent hose Ø 8 mm internal, Ø 12 mm external	4,60 €

V

HIDROMASAŽA – KOMANDE PIEZO

INSTALACIONI SET ZA ELEKTRIČNE PREKIDAČE PIEZO SUPPORT PLATE FOR PIEZO ELECTRICAL SWITCH



cod. 1070646
instalacioni set HYDRO

cod. 1070647
instalacioni set AIR

cod. 1070648
instalacioni set LIGHT

Šifra / code	Opis /description	Cena/ price
SET ZA INSTALACIJU ELEKTRIČNIH PREKIDAČA PIEZO ZA BETONSKE BAZENE, LAJNER I TANKE ZIDOVE U sastavu: mlaznica 2", šrafovi i laser ploča izgravirana aisi 316 ø99 mmsa ø22 mm - (bez prekidača) ELECTRICAL SWITCHS INSTALLATION KIT FOR CEMENT POOLS, LINER AND THIN WALL Including: 2" nozzle, bolts and stainless steel aisi 316 plate engraved ø99 mm with ø22 mm push button hole - (excluding switch)		
1070646	INSTALACIONI SET - natpis HYDRO (hidromasaža) / INSTALLATION KIT - HYDRO	119,00 €
1070647	INSTALACIONI SET - natpis AIR (aria) / INSTALLATION KIT - AIR	119,00 €
1070648	INSTALACIONI SET - natpis LIGHT (svetlo) / INSTALLATION KIT - LIGHT	119,00 €



INSTALACIONI SET SA ELEKTRIČNIM PREKIDAČIMA PIEZO SA POZADINSKOM RASVETOM
LED

OPREMA ZA HIDROMASAŽNE KLUPE / ACCESSORIES SUPPLY FOR HYDROMASSAGE BENCHES



cod. 1070710

cod. 1040059

cod. 1040087

cod. 1070622

Šifra/code	Opis /description	Cena/price
1070715	T reduktovan 32x50x32 / T reduced 32x50x32	10,40 €
KOLEKTORI SA VIŠE IZLAZA		
1070710	4 smerni prodorni razvodnik 1/2" za lepljenje priključka 1 1/2 f* / Manifold 4 outputs	7,70 €
1070711	4 smerni prodorni razvodnik 1/2" za lepljenje priključka 2" f* / Manifold 4 outputs	8,20 €
1070712	4 smerni prodorni razvodnik 3/4" za lepljenje priključka 1 1/2 f* / Manifold 4 outputs	7,80 €
1070713	4 smerni prodorni razvodnik 3/4" za lepljenje priključka 2" f* / Manifold 4 outputs	8,20 €
1070714	4 smerni margherita razvodnik 1" za lepljenje priključka 1 1/2 f* / Manifold 4 outputs	14,50 €
1035331	Fleksibilna PVC cev bela IDRO-FLEX di Ø 32 mm-al m / white flexible PVC huge Idroflex ø32 m	4,60 €
1040059	Bistabilni elektropneumatski pretvarač / electropneumatic bistable transducer	23,90 €
1040083	Monostabilni elektropneumatski pretvarač / electropneumatic monostable transducer	26,90 €
1040087	Bistabilni elektropneumatski pretvarač od 3 kontakta / electropneumatic bistable transducer 3 con.	31,20 €
1070622	Nepovratni ventil za vazduh Ø 50 mm / Air check valve Ø 50 mm	32,60 €
1070623	Nepovratni ventil za vazduh Ø 63 mm / Air check valve Ø 63 mm	41,90 €

**HIDROMASAŽNI SET ZA STRUKTURE U GRADNJI
KIT HYDROMASSAGE FOR CAST IN PLACE STRUCTURES**



KOMPLETAN HIDROMASAŽNI SET ZA UZIDANE PROSTORE SASTOJI SE OD:

THE COMPLETE KIT FOR MANSORY HOUSING CONSISTS OF:

- SET T VENTURI I FITINZI (A)
- SET PUMPA I PANEL (B)
- SET HIDROMASAŽNI KOMPRESOR (C)
- T VENTURI KIT AND FITTINGS (A)
- KIT PUMP AND PANEL (B)
- KIT HYDROMASSAGE BLOWER (C)

KOMPLETAN SET HIDROMASAŽE SA FIBERGLAS PROSTOROM U SASTAVU:

THE COMPLETE KIT WITH FIBERGLASS HOUSING CONSISTS OF:

- SET T VENTURI I FITINZI (A)
- SET HIDROMASAŽNI KOMPRESOR (C)
- SET SPA LOKAL OD FIBERGLASAD
- T VENTURI KIT AND FITTINGS (A)
- KIT HYDROMASSAGE BLOWER (C)
- KIT LOCAL RESIN SPA (D)

SET PRIPREMA			
SET T VENTURI I SET FITINZI (A): <i>KIT VENTURI KIT AND FITTINGS (A):</i> mlaznice T venturi (mešavina vazduh i voda) Usis vazduha Ø20 Mlaznice sa rešetkom fleksibilna PVC cev Ø20 Fleksibilna PVC cev Ø50 Fleksibilna PVC cev Ø63 fitting za povezivanje lepak za fitting		SET PUMPA I PANEL (B): <i>KIT PUMP AND PANEL (B):</i> Set4/6T:pumpaARCA 1500A bez prefiltera Set 8T: ARCA 2200 Kontrolni pneumatski panel kompletan sa prekidačem fitinzima, lepkom i poveznim cevima.	
SET HIDROMASAŽNI KOMPRESOR(C): <i>KIT HYDROMASSAGE BLOWER (C):</i> Set 4/6 T: blower kompresor od 900W Set 8 T:kompresor od 1200W Pneumatski komadni prekidač Fitinzi I cevi za povezivanje		SET SA PROSTORIJOM OD FIBERGLASA PRE-SASTAV. (D): <i>KIT WITH LOCAL RESIN PREASSEMBLED (D):</i> Set4/6T:slivnik SPAmc/h 22 c/pumpa Arca 1500° Kontrolni pneumatski panel sa prekidačem Set6/8T:slivnikSPA mc/h 40,Pumpa ARCA 2200, pneumatski komadni panel sa prekidačem	

IMPIANTO/EQUIPMENT

SET UZIDNI LOKALI ZA SMEŠTAJ PUMPE I KONTROLNA TABLA
KIT FOR MANSORY HOUSING LOCAL: PUMP AND CONTROL BOARD

Opis	Se T venturi i fitinzi- A:		Set pumpa i panel B:		Set kompresor hidromasaže C:		Set kompletan A+B+C	
	Šifre	Cena	Šifre	Cena	Šifre	Cena	Šifre	Cena
Set4Tventuri+4ventilacije	1030121	606,90 €	1030182	1.140,80 €	1030190	922,00 €	1030210	2.710,00 €
Set6Tventuri+6ventilacije	1030168	786,40 €	1030183	1.323,90 €	1030191	930,40 €	1030211	3.097,00 €
Set8Tventuri+8ventilacije	1030169	975,10 €	1030186	1.896,40 €	1030192	954,70 €	1030212	3.875,00 €

SET SA PROSTOROM OD FIBERGLASA ZA SMEŠTAJ PUMPE I KONTROLNOG PANELO
KIT FOR VTR HOUSING LOCAL: PUMP AND CONTROL BOARD

Opis	Set T venturi i fitinziA:		Set kompreosr hidromasaža C:		Set saprostoromSpa fiberglasD:		Set kompletan A+C+D	
	šifre	Cena	Šifre	Cena	Šifre	Cena	Šifre	Cena
Set 4 T venturi + 4 ventilacije	1030121	606,90 €	1030193	922,00 €	1010054	2.092,20 €	1030213	3.655,00 €
Set 6 T venturi + 6 ventilacija	1030168	786,40 €	1030194	930,40 €	1010055	2.490,20 €	1030214	4.256,00 €
Set 8 T venturi + 8 ventilacija vazduha	1030169	975,10 €	1030195	954,70 €	1010055	2.490,20 €	1030215	4.085,00 €

PRE-MONTIRANI HIDROMASAŽNI SET ZASTEPENIŠTE ROMANE OD AKRILA



KOMPLETNI PRE-MONTIRANI HIDROMASAŽNI SET (UZIDNI LOKALI) U SASTAVU:

THE COMPLETE PRE-ASSEMBLED HYDROMASSAGE KIT (MANSORY HOUSING) CONSISTS OF:

- PREMONTIRANI HIDROMASAŽNI SET(A)
- SET UZIDNOG LOKALA (B)
 - PRE-ASSEMBLEDHYDROMASSAGEKIT(A)
 - KIT LOCAL IN MASONRY (B)

KOMPLETNI PRE-MONTIRANI HIDROMASAŽNI SET (LOKALI VTR) U SASTAVU:

THE COMPLETE PRE-ASSEMBLED HYDROMASSAGE KIT (VTR HOUSING) CONSISTS OF:

- SET PREMONTIRANI HIDROMASAŽ(A)
- SET LOKALA SPA FIBERGLAS(C)
- PREASSEMBLED MASSAGE KIT (A)
- KIT RESIN LOCAL SPA (C)

SET PREMONTIRANE HIDROMASAŽE (A) U SASTAVU:

bušenje stepeništa	drilling scale
Hydro mlaznice	Hydro jets
Usisne mlaznice (kit 4/6T:1pz; Kit 8T:2 pz)	suction nozzles (kit 4/6T:1; Kit 8T:2)
Fleksibilna PVC cev	flexible pvc tube
fiting	fittings
Lepak za fiting	glue forfittings

SET ZA UZIDNI LOKAL (B) U SASTAVU:

Pumpa ARCA 1500A bez predfiltera	pump ARCA 1500A without prefilter
Set 4/6 T: kompresor da 900 Watt	Pneumatic control panel with button
Kit 8 T: kompresor od 1200 Watt	Kit 4/6 T: blower 900 Watt
Fleksibilna pvc cev	Kit 8 T: blower 1200 Watt
fiting	flexible pvc tube
Lepak za fiting	fittings
	glue for fittings

SET SA LOKALOM SPA OD FIBERGLASA :

slivnik SPA mc/h 22 sa pumpom ARCA 1500A, komadnim pneumatskim panelom	Technical housing SPA mc/h 22 w/pump ARCA 1500A, pneumatic control panel
Set 4/6 T: blower kompresor 900 Watt	Kit 4/6 T: blower 900 Watt
Kit 8 T: blower kompresor 1200 Watt	Kit 8 T: blower 1200 Watt
cev PVC fleksibilna fitinzi	flexible pvc tube fittings

SET UZIDNIH LOKALA ZA SMEŠTAJ PUMPE, KOMPRESORA I KONTROLNOG PANELA KIT FOR MANSORY HOUSING LOCAL: PUMP, BLOWER AND CONTROL BOARD

Opis	Premontirani set hidromasaže A:		Set za uzidni lokal B:		Kompletirani premontirani set A+B	
	Šifre	Cena	Šifre	Cena	Šifre	Cena
Set 4 hidromasažnih mlaznica/ kit 4 hydro return fitting	1030120	458,60 €	1030162	1.754,00 €	1030200	2.179,00 €
Set 6 hidromasažnih mlaznica/ kit 6hydroreturnfitting	1030122	547,40 €	1030163	1.999,50 €	1030201	2.503,00 €
Set 8 hidromasažnih mlaznica/ kit 8hydroreturnfitting	1030123	820,50 €	1030163	1.999,50 €	1030202	2.779,00 €

SET LOKALA VTR ZA SMEŠTAJ PUMPE, KOMPRESORA I KONTROLNOG PANELA KIT FOR VTR HOUSING LOCAL: PUMP, BLOWER AND CONTROL BOARD

Opis	Set hidromasaža premontirani A:		Set sa lokal SPA in vtr C:		Set KOMPLETAN premontiran A+C	
	Šifre	Cena	Šifre	Cena	Šifre	Cena
Set 4 hidromasažnih mlaznica/ kit 4hydroreturnfitting	1030120	458,60 €	1030180	2.839,00 €	1030204	3.526,00 €
Set 6 hidromasažnih mlaznica/ kit 6hydroreturnfitting	1030122	548,50 €	1030180	2.839,00 €	1030205	3.617,00 €
Set 8 hidromasažnih mlaznica/ kit 8hydroreturnfitting	1030123	820,50 €	1030187	2.867,00 €	1030206	3.914,00 €



**FITING OD PVC-A
- KOLENA, KRIVINE, KRSTOVI**



**MODULIZA RAZVODNIK OD PVC
IN PN 10**



**FITING OD PVC-A
- KAPE**



FITINZI PVC pod pritiskom



**FITING OD PVC-A
- HOLANDER**



KUGLIČNI VENTIL



T-RAČVA OD PVC-A



LEPTIRASTI VENTILI



**FITING U PVC-U
- ADAPTERI**



PROTIVPOVRATNI VENTIL



**FITING OD PVC-A
- REDUKTORI**



**FLANŠE, DIHTUNZI, OBRUČI,
ŠRAVOVI, ŠAJBNE I NOSAČI**



**FITING U PVC-U
- PRIKLJUČAK ZA
REZERVOARE, ZIDNI
PRODOR VDL**



**ANTIVIBRACIONE PRIRUBNICE DANFOS
SOCLA SA ČELIČNOM
GALVANIZIRANOM FLANŠOM**



**FITING OD PVC-A
- SPOJNICE**



SPOJNICE ZA PROLAZ TEČNOSTI



**FITING OD PVC-A
ZA LEPLJENJE**

KOLENO 90° NA LEPLJENJE
90° GLUING ELBOW



Šifra	opis	Cena
1035000	Koleno na lepljenje 90° fi 16	0,84 €
1035001	Koleno na lepljenje 90° fi 20	1,66 €
1035002	Koleno na lepljenje 90° fi 25	2,00 €
1035012	Koleno na lepljenje a 90° fi 32	2,40 €
1035015	Koleno na lepljenje a 90° fi 40	2,50 €
1035003	Koleno na lepljenje a 90° fi 50	3,64 €
1035004	Koleno na lepljenje a 90° fi 63	5,10 €
1035005	Koleno na lepljenje 90° fi 75	11,20 €
1035006	Koleno na lepljenje a 90° fi 90	14,70 €
1035007	Koleno na lepljenje a 90° fi 110	21,70 €
1035008	Koleno na lepljenje a 90° fi 125	44,70 €
1035009	Koleno na lepljenje a 90° fi 140	54,30 €
1035010	Koleno na lepljenje a 90° fi 160	84,80 €
1035011	Koleno na lepljenje 90° fi 200	165,80 €
1035900	Koleno na lepljenje a 90° fi 225	334,20 €
1035650	Koleno na lepljenje a 90° fi 250	432,40 €
1035651	Koleno na lepljenje a 90° fi 315	753,80 €
1034998	Koleno na lepljenje a 90° fi 400	Na zahtev

KOLENO 45° NA LEPLJENJE
45° GLUING ELBOW



Šifra	Opis	Cena
1035027	a 45° Ø 16	2,60 €
1035016	Koleno na lepljenje a 45° Ø 20	2,70 €
1035017	Koleno na lepljenje a 45° Ø 25	2,70 €
1035031	Koleno na lepljenje a 45° Ø 32	2,70 €
1035433	Koleno na lepljenje a 45° Ø 40	5,00 €
1035018	Koleno na lepljenje a 45° Ø 50	5,20 €
1035019	Koleno na lepljenje a 45° Ø 63	6,20 €
1035020	Koleno na lepljenje a 45° Ø 75	10,20 €
1035021	Koleno na lepljenje a 45° Ø 90	14,50 €
1035022	Koleno na lepljenje a 45° Ø 110	30,80 €
1035023	Koleno na lepljenje a 45° Ø 125	40,50 €
1035024	Koleno na lepljenje a 45° Ø 140	60,10 €
1035025	Koleno na lepljenje a 45° Ø 160	70,80 €
1035026	Koleno na lepljenje a 45° Ø 200	166,30 €
1035435	Koleno na lepljenje a 45° Ø 225	243,40 €
1035436	Koleno na lepljenje a 45° Ø 250	405,00 €
1035437	Koleno na lepljenje a 45° Ø 315	756,50 €
1034999	Koleno na lepljenje a 45° Ø 400	Na zahtev

KOLENO 90° SA NAVOJEM
90° THREADED ELBOW



Šifra	Opis	Cena
1035389	Koleno a 90° sa navojem 3/8"	2,30 €
1035390	Koleno a 90° sa navojem 1/2"	2,50 €
1035391	Koleno a 90° sa navojem 3/4"	3,00 €
1035392	Koleno a 90° sa navojem 1"	3,50 €
1035028	Koleno a 90° sa navojem 1" 1/2	8,70 €
1035029	Koleno a 90° sa navojem 2"	12,20 €
1035393	Koleno a 90° sa navojem 2" 1/2	29,90 €
1035394	Koleno a 90° sa navojem 3"	42,10 €
1035395	Koleno a 90° sa navojem 4"	69,20 €

KOLENO 45° SA NAVOJEM
45° THREADED ELBOW



Šifra	Opis	Cena
1035559	Koleno a 45° sa navojem 3/8"	5,00 €
1035560	Koleno a 45° sa navojem 1/2"	5,10 €
1035561	Koleno a 45° sa navojem 3/4"	5,60 €
1035562	Koleno a 45° sa navojem 1"	6,90 €
1035563	Koleno a 45° sa navojem 1" 1/2	12,30 €
1035564	Koleno a 45° sa navojem 2"	18,00 €

LAKAT 90° NA LEPLJENJE M/F
M/F 90° GLUING ELBOW



Šifra	Opis	Cena
1035013	Koleno na lepljenje a 90° M/Fa 50	6,00 €
1035014	Koleno na lepljenje a 90° M/Fa 63	8,40 €

KOLENO 90° I SPOJ SA NAVOJEM 90°
ELBOW WITH THREADED CONNECTION



Šifra	Opis	Cena
1035810	Koleno a 90° fi 50 gornji spoj sa navojem 1/2"	9,80 €
1035811	Koleno a 90° fi 63 gornji spoj sa navojem 1/2"	12,80 €
1035812	Koleno 90° fi 90 gornji spoj sa navojem 3/4"	28,90 €
1035813	Koleno a 90° fi 110 gornji spoj sa navojem 1"	55,20 €
1035814	Koleno a 90° fi 50 bočni spoj sa navojem 1/2"	10,90 €
1035815	Koleno a 90° fi 63 bočni spoj sa navojem 1/2"	13,90 €
1035816	Koleno a 90° fi 90 bočni spoj sa navojem 3/4"	35,10 €
1035817	Koleno a 90° fi 110 bočni spoj sa navojem 1"	65,30 €

LUK VELIKIRADIJSNA LEPLJENJE
WIDE-RADIUS BONDING CURVE



Šifra	Opis	Cena
1035760	Luk na lepljenje a 90° Ø 50	12,00 €
1035439	Luk na lepljenje 90° Ø 63	26,30 €

TROSMERNO
KOLENO



Šifra	Opis	Cena
1035535	Trosmerno koleno Ø 50	10,60 €
1035536	Trosmerno koleno Ø 63	15,20 €

KRST NA LEPLJENJE
GLUING CROSS



Šifra	Opis	Cena
1035032	Krst na lepljenje Ø 50	10,90 €
1035033	Krst na lepljenje Ø 63	16,20 €
1035251	Krst na lepljenje Ø 75	50,20 €
1035034	Krst na lepljenje Ø 90	70,40 €
1035256	Krst na lepljenje Ø 110	132,20 €

FITING I CEVI

FITING U PVC-U - KAPE

ŽENSKI ČEP NA LEPLJENJE END CAP			
Šifra	Opis	Cena	
1035700	Ženski čep na lepljenje Ø 20	0,94 €	
1035396	Ženski čep na lepljenje Ø 25	0,94 €	
1035701	Ženski čep na lepljenje Ø 32	1,05 €	
1035047	Ženski čep na lepljenje Ø 40	1,60 €	
1035048	Ženski čep na lepljenje Ø 50	2,20 €	
1035049	Ženski čep na lepljenje Ø 63	3,00 €	
1035050	Ženski čep na lepljenje Ø 75	7,30 €	
1035051	Ženski čep na lepljenje Ø 90	9,90 €	
1035052	Ženski čep na lepljenje Ø 110	14,00 €	
1035046	Ženski čep na lepljenje Ø 125	23,70 €	
1035053	Ženski čep na lepljenje Ø 140	25,40 €	
1035054	Ženski čep na lepljenje Ø 160	35,70 €	
1035702	Ženski čep na lepljenje Ø 200	113,80 €	
1035703	Ženski čep na lepljenje Ø 225	143,40 €	
1035794	Ženski čep na lepljenje Ø 250	277,90 €	
1035714	Ženski čep na lepljenje Ø 315	483,90 €	
1035715	Ženski čep na lepljenje Ø 400	Na zahtev	

ČEP SA NAVOJEM THREADED END CAP		
Šifra	Opis	Cena
1035591	Čep sa navojem Ø 3/8"	2,00 €
1035586	Čep sa navojem Ø 1/2"	2,20 €
1035587	Čep sa navojem Ø 3/4"	2,60 €
1035588	Čep sa navojem Ø 1"	3,00 €
1035589	Čep sa navojem Ø 1 1/2"	3,10 €
1035590	Čep sa navojem Ø 2"	4,06 €

FITING U PVC-U - HOLANDERI

HOLANDER NA LEPLJENJE			
Šifra	Opis	Cena	
1035035	Holander na lepljenje Ø 20	0,75 €	
1035200	Holander na lepljenje Ø 25	0,85 €	
1035036	Holander na lepljenje Ø 32	0,94 €	
1035201	Holander na lepljenje Ø 40	1,46 €	
1035037	Holander na lepljenje Ø 50	1,90 €	
1035038	Holander na lepljenje Ø 63	2,60 €	
1035039	Holander na lepljenje Ø 75	6,34 €	
1035040	Holander na lepljenje Ø 90	10,60 €	
1035041	Holander na lepljenje Ø 110	14,70 €	
1035042	Holander na lepljenje Ø 125	24,70 €	
1035043	Holander na lepljenje Ø 140	32,00 €	
1035044	Holander na lepljenje Ø 160	38,10 €	
1035045	Holander na lepljenje Ø 200	91,30 €	
1035440	Holander na lepljenje Ø 225	104,80 €	
1035441	Holander na lepljenje Ø 250	247,30 €	
1035442	Holander na lepljenje Ø 315	379,50 €	
1035716	Holander na lepljenje Ø 400	584,30 E	

HOLANDER NA LEPLJENJE SA NAVOJEM			
Šifra	Opis	Mere	Cena
1035115	Holander na lepljenje sa navojem	40x1 1/4"	2,80 €
1035116	Holander na lepljenje sa navojem	50x1 1/2"	4,40 €
1035117	Holander na lepljenje sa navojem	63x2"	5,70 €
1035118	Holander na lepljenje sa navojem	75x2 1/2"	17,00 €
1035119	Holander na lepljenje sa navojem	90x3"	19,00 €
1035120	Holander na lepljenje sa navojem	110x4"	44,80 €
1035121	Holander na lepljenje sa navojem	125x5"	93,00 €

HOLANDER SA NAVOJEM		
Šifra	Opis	Cena
1035850	Holander sa navojem 3/8"	2,40 €
1035122	Holander sa navojem 1/2"	2,70 €
1035123	Holander sa navojem 3/4"	2,80 €
1035126	Holander sa navojem 1"	3,50 €
1035124	Holander sa navojem 1 1/2"	3,95 €
1035125	Holander sa navojem 2"	5,40 €
1035127	Holander sa navojem 2 1/2"	15,80 €
1035139	Holander sa navojem 6"	106,00 €

REDUKOVANI HOLANDER / REDUCED COUPLING			
Šifra	Opis	Mere inč / metrični	Cena
1070697	Redukovani holander	48x50	3,60 €

REDUKOVANI HOLANDER INČI / METRIČNI REDUCED COUPLING INCH / METRIC			
Šifra	Opis	Mere inč / metrični	Cena
1070698	Holand.reduk. M/F	1/2"x20	6,20 €
1070704	Holand.reduk. M/F	1"x32	2,70 €
1070699	Holand.reduk. M/F	48x50	5,80 €
1070700	Holand.reduk. M/F	60x63	9,20 €

REDUKOVANI HOLANDER / REDUCED COUPLING			
Šifra	Opis	Mere	Cena
1035361	Reduk. holander	32x25	1,35 €
1035901	Reduk.holander	63x50	3,22 €
1035135	Reduk.holander	75x63	10,50 €
1035136	Reduk.holander	90x75	10,90 €
1035137	Reduk.holander	110x90	16,00 €

FITING U PVC-U - T

T EKAL ŽENSKI NA LEPLJENJE/GLUINGFEMALETEE

Codice	Descrizione	CENA
1035070	T uguale femm da incollare a 20	1,20 €
1035071	T uguale femm da incollare a 25	1,40 €
1035072	T uguale femm da incollare a 32	1,80 €
1035073	T žen.račve na lepljenje fi 40	2,90 €
1035074	T žen.račve na lepljenjea fi 50	4,20 €
1035075	T žen.račve na lepljenje fi 63	6,30 €
1035076	T ženske račve na lepljenje fi 75	11,80 €
1035077	T ženske račve na lepljenje fi 90	16,90 €
1035078	T ženske račve na lepljenje fi 110	27,60 €
1035079	T ženske račve na lepljenje fi 125	57,00 €
1035080	T ženske račve na lepljenje fi 140	77,80 €
1035081	T ženske račve na lepljenje fi 160	94,10 €
1035082	T ženske račve na lepljenje fi 200	191,60€
1035445	T ženske račve na lepljenje fi 225	241,40€
1035446	T ženske račve na lepljenje fi 250	524,00€
1035447	T ženske račve na lepljenje fi 315	970,60€
1035448	T ženske račve na lepljenje fi 400	surichiasta

T REDUKOVAN NA LEPLJENJE/REDUCED GLUING TEE

Šifra	Opis	Mere	Cena
1035278	T redukovan lepiti	32 x 20 x 32	3,20 €
1035059	T redukovan lepiti	50 x 20 x 50	4,20 €
1035083	T redukovan lepiti	50 x 32 x 50	4,20 €
1035500	T redikovan lepiti	63 x 20 x 63	11,40 €
1035085	T redukovan lepiti	63 x 32 x 63	11,40 €
1035087	T redukovan lepiti	63 x 50 x 63	11,40 €
1035089	T redukovan lepiti	75 x 50 x 75	12,50 €
1035090	T redukovan lepiti	75 x 63 x 75	12,50 €
1035091	T redukovan lepiti	90 x 50 x 90	18,30 €
1035092	T redukovan lepiti	90 x 63 x 90	18,30 €
1035909	T redukovan lepiti	90 x 75 x 90	29,80 €
1035710	T redukovan lepiti	110 x 63 x 110	30,60 €
1035279	T redukovan lepiti	110 x 75 x 110	30,60 €
1035711	T redukovan lepiti	110 x 90 x 110	45,90 €
1035712	T redukovan lepiti	125 x 63 x 125	115,50 €
1035284	T redukovan lepiti	125 x 90 x 125	118,80 €
1035285	T redukovan lepiti	125x 110x 125	118,80 €

T ZA KOLEKTORA / TEE FOR MANIFOLD

Codice	Descrizione	Misureinc/metrico	Prezzo
1035094	Tza kolektora	90x75x63C=50x40	32,80 €
1035095	T za kolektora	40x125x110C=63x50	120,00€

T dvostruki/ DOUBLE EXTENSIONTEE

1035096	T dvostruki.	90x75x63C=50x40	42,20€
---------	--------------	-----------------	--------

ŠIFRA	OPIS	MERA INČ METRIČKA	CENA
Codice	Descrizione	Misureinc/metrico	Prezzo

T SA NAVOJEM NA LEPLJENJE

1070701	T leplj.navoj	50x1"½x50	6,24 €
---------	---------------	-----------	--------

T SA NAVOJEM/ THREADED TEE

Šifra	Opis	Mera Inč metrični metrico	cena
1035554	T sa navojem	3/8"	2,80 €
1035555	T sa navojem	1/2"	3,00 €
1035556	T sa navojem	3/4"	3,70 €
1035720	T sa navojem	1"	4,70 €
1035097	T sa navojem	1" ½	29,30 €
1035098	T sa navojem	2"	29,30 €
1035557	T sa navojem	2" ½	35,70 €

FITING U PVC-U - ADDAPTERI

ADAPTER MUŠKI 3 PREČNIKA SA NAVOJEM
MALE THREADED ADAPTOR 3 DIAMETERS

Šifra	Opis	Mere	PCena
1035186	Adapter spoljni navoj	20x25x3/8"	2,10 €
1035100	Adapter spoljni navoj	20x25x½"	2,20 €
1036222	Adapter spoljni navoj	20x25x3/4"	2,20€
1035101	Adapter spoljni navoj	25x32x¾"	2,40€
1035397	Adapter spoljni navoj	25x32x½"	2,50 €
1035102	Adapter spoljni navoj	25x32x1"	2,50 €
1035103	Adapter spoljni navoj	32x40x1"	2,50 €
1036245	Adapter spoljni navoj	32x40x1"¼	3,00 €
1035104	Adapter spoljni navoj	40x50x1"½	3,10 €
1036246	Adapter spolni navoj	50x63x1" ¼	5,90 €
1035105	Adapter spoljni navoj	50x63x1"½	6,15 €
1035106	Adapter spoljni navoj	50x63x2"	6,15 €
1035107	Adapter spoljni navoj	63x75x2"	6,15 €
1035108	Adapter spoljni navoj	63x75x2"½	6,15 €
1035109	Adapter spoljni navoj	75x90x2"½	13,20 €
1035110	Adapter muški navoj	75x90x3"	20,90 €
1035111	Adapter muški navoj	90x110x2"½	25,10 €
1035114	Adapter muški navoi	90x110x3"	26,10 €
1035112	Adapter muški navoj	110x125x3"	38,80 €
1035113	Adapter muški navoj	125x140x5"	56,10 €

ADAPTER DVA PREČNIKASA NAVOJEM ŽENSKI
FEMALE THREADED ADAPTOR 2 DIAMETERS

Šifra	Opis	Mere	Cene
1035191	Adapter navoj ženski	20x½"	1,45 €
1035192	Adapter navoj ženski	25x¾"	1,90 €
1035193	Adapter navoj ženski filettato	32x1"	2,50 €
1035217	Adapter navoj ženski	50x1¼"	5,50€
1035194	Adapter navoj ženski	50x1½"	5,70€
1035195	Adapter navoj ženski	63x2"	6,15€
1035196	Adapter navoj ženski	75x2½"	9,70€
1035197	Adapter navoj žen.	90x3"	19,50€
1035198	Adapter navoj žen.	110x4"	35,50€

FITING U PVC-U - REDUKTORI

REDUKTORI ZA LEPLJENJE / GLUING REDUCING

Šifra	Opis	Mere	Cena
1035140	Reduktor za lepljenje	25 x 20	0,73 €
1035141	Reduktor za lepljenje	32 x 20	0,94 €
1036220	Reduktor za lepljenje	40 x 32	1,14 €
1036221	Reduktor za lepljenje	50 x 25	2,30 €
1035142	Reduktor za lepljenje	50 x 32	2,30 €
1035143	Reduktor za lepljenje	50 x 40	2,30 €
1035144	Reduktor za lepljenje	63 x 40	2,30 €
1035145	Reduktor za lepljenje	63 x 50	2,30 €
1035146	Reduktor za lepljenje	75 x 50	3,54 €
1035147	Reduktor za lepljenje	75 x 63	3,54 €
1035164	Reduktor za lepljenje	90 x 50	7,10 €
1035148	Reduktor za lepljenje	90 x 63	7,10 €
1035149	Reduktor za lepljenje	90 x 75	7,10 €
1035150	Reduktor za lepljenje	110 x 63	10,40 €
1035151	Reduktor za lepljenje	110 x 75	10,40 €
1035152	Reduktor za lepljenje	110 x 90	10,40 €
1035153	Reduktor za lepljenje	125 x 75	15,50 €
1035154	Reduktor za lepljenje	125 x 90	15,50 €
1035155	Reduktor za lepljenje	125 x 110	15,50 €
1035156	Reduktor za lepljenje	140 x 90	21,90 €
1035157	Reduktor za lepljenje	140 x 110	21,90 €
1035158	Reduktor za lepljenje	140 x 125	21,90 €
1035159	Reduktor za lepljenje	160 x 110	24,40 €
1035160	Reduktor za lepljenje	160 x 125	24,40 €
1035161	Reduktor za lepljenje	160 x 140	24,40 €
1035162	Reduktor za lepljenje	200 x 160	57,60 €
1035902	Reduktor za lepljenje	225 x 160	92,90 €
1035903	Reduktor za lepljenje	225 x 200	91,10 €
1035704	Reduktor za lepljenje	250 x 160	216,10 €
1035705	Reduktor za lepljenje	250 x 200	228,70 €
1035706	Reduktor za lepljenje	250 x 225	216,10 €
1035707	Reduktor za lepljenje	315 x 200	281,00 €
1035708	Reduktor za lepljenje	315 x 225	258,90 €
1035709	Reduktor za lepljenje	315 x 250	281,00 €
1035717	Reduktor za lepljenje	400 x 200	NA UPIT
1035718	Reduktor za lepljenje	400 x 315	NA UPIT

REDUKTOR SA NAVOJEM
THREADED REDUCING

Šifra	Opis	Mere	Cena
1035725	Reduktor sa nav.	½"x3/8"	1,35 €
1035166	Reduktor sa nav.	¾"x½"	1,35 €
1035165	Reduktor sa nav.	1"x½"	1,66 €
1035167	Reduktor sa nav.	1"x¾"	2,80 €
1035489	Reduktor sa nav.	1"¼x1"	4,00 €
1035501	Reduktor sa nav.	1"½x¾"	5,20 €
1035168	Reduktor sa nav.	1"½x1"	5,40 €
1035502	Reduktor sa nav.	1"½x1"¼"	5,20 €
1035503	Reduktor sa nav.	2"x1"	7,00 €
1035169	Reduktor sa nav.	2"x1"½"	7,00 €
1035504	Reduktor sa nav.	2"½x1"½"	13,90 €
1035726	Reduktor sa nav.	3"x2"½"	21,40 €
1035727	Reduktor sa nav.	4"x2"½"	34,60 €
1035505	Reduktor sa nav.	4"x3"	34,60 €

ZIDNI PRODOR KOMPENZACIONA
KADA

Šifra	Opis	Mere	Cena
1035872	Prodor PVC	Ø 110	345,60 €
1035874	Prodor PVC	Ø 160	522,00 €

FITING U PVC-U - PRIKLJUČAK ZA REZERVOARE, ZIDNI PRODOR VDL

PRIKLJUČAK ZA REZERVOARE/TANKCOUPLING

Šifra	Opis	Mere	Cena
1035772	Priključak za rezerv. PE	1"½-2"x50-40	12,60 €
1035773	Priključak za rezerv. PE	2"-2"½x63-50	16,30 €
1035592	Priključak na rezerv.	Ø1" ½	11,80 €

ZIDNI PRODOR VDL / VDL THROUGH WALL

Šifra	Opis	Mere	Cena
1035130	Zidni prodor	2"x50/63	41,30 €
1035131	Zidni prodor	2"½x63/75	81,50 €
1035132	Zidni prodor	3"x75/90	97,30 €
1035133	Zidni prodor	4"x110/125	162,80 €
1035486	Zidni prodor	¾"x20/25	25,30 €
1035485	Zidni prodor	1"x25/32	27,40 €
1035484	Zidni prodor	1"¼x32/40	30,40 €

FITING U PVC-U - SPOJNICE

SPOJNICA MUŠKI PRIKLJUČAK
MALE COUPLING

Šifra	Opis	Mere	Cena
1035183	Spojnic m.priključak	50x1"½	13,40 €
1035185	Spojnic m.priključak	50x2"	13,40 €
1035184	Spojnic m.priključak	63x2"	18,50 €

PVC SPOJNICA/MESING
PVC/BRASS UNION

Šifra	Opis	Mere	Cena
1035595	Spojnic pvc/mesing F/F	63x2"	101,20 €
1035596	Spoj. pvc/mesing M/F	50x1"½	68,40 €
1035187	Spojnic. pvc/mesing M/F	63x2"	103,60 €

SPOJNICA SA O PRSTENOM ZA LEPLJENJE
GLUING UNION WITH O-RING

Šifra	Opis	Mere	Cena
1035175	Spojnic 3kom.lepljenje	Ø 20	3,90 €
1035176	Spojnic 3kom.lepljenje	Ø 25	3,90 €
1035177	Spojnic 3kom.lepljenje	Ø 32	5,40 €
1035453	Spojnic 3kom.lepljenje	Ø 40	6,60 €
1035178	Spojnic 3kom.lepljenje	Ø 50	9,00 €
1035179	Spojnic 3kom.lepljenje	Ø 63	12,40 €
1035180	Spojnic 3kom.lepljenje	Ø 75	38,60 €
1035181	Spojnic 3kom.lepljenje	Ø 90	44,70 €
1035182	Spojnic 3kom lepljenje	Ø 110	51,50 €

PRSTEN SPOJNICE
RING NUT FOR COUPLING

Šifra	Opis	Cena
1035540	Prsten spojnice Ø 50	5,60 €
1035541	Prsten spojnice Ø 63	8,20 €
1035542	Prsten spojnice Ø 75	25,50 €
1035543	Prsten spojnice Ø 110	34,90 €

FIKSNI DEO ZA SPOJNICU
FIXED PART FOR UNION

Šifra	Opis	Cena
1035545	Fiksni deo za Spojnicu Ø 50	5,60 €
1035546	Fiksni deo za spojnicu Ø 63	7,30 €
1035547	Fiksni deo za spojnicu Ø 75	20,30 €
1035548	Fiksni deo za spojnicu Ø 110	26,20 €

NEUTRALNI KOMAD ZA SPOJN.
LOOSEPIECEFORUNION

Šifra	Opis	Cena
1035550	Neutralni kom. za spoj. Ø 50	3,60 €
1035551	Neutralni kom.za spoj. Ø 63	5,10 €
1035552	Neutralni kom.za spoj. Ø 75	13,60 €
1035553	Neutralni kom.za spoj. Ø 110	19,80 €

SPOJNICA SA O PRSTEN. SA NAVOJEM
THREADED UNION WITH O-RING

Šifra	Opis	Mere	Cena
1035585	Spojnic sa O prstenom sa navojem	Ø 1"½	12,30 €

FITING U PVC-U ZA LEPLJENJE

ČEP SA NAVOJEM/ THREADED CAP



Šifra	Opis	Cena
1035565	Čep sa navojemØ 3/8"	1,60 €
1035566	Čep sa navojemØ 1/2"	1,66 €
1035567	Čep sa navojemØ 3/4"	2,10 €
1035568	Čep sa navojemØ 1"	2,60 €
1035569	Čep sa navojemØ 1"½	2,70 €
1035570	Čep sa navojemØ 2"	3,40 €
1035571	Čep sa navojemØ 2"½	19,30 €
1035572	Čep sa navojemØ 3"	22,50 €
1035573	Čep sa navojemØ 4"	38,50 €

GRANA ZA LEPLJENJE MUŠKA / ŽENSKA
MALE/FEMALE BONDING DERIVATION

Šifra	Opis	Mere	Cena
1035600	Grana za leplj. m/ž	75x50x63	8,00 €
1035457	Grana za leplj.m/ž	90x50x63	8,90 €
1035631	Grana za leplj.m/ž	90x63x75	9,20 €
1035618	Grana za leplj.m/ž	110x50x63	9,80 €
1035623	Grana za leplj.m/ž	110x63x75	9,80 €
1035731	Grana za leplj.m/ž	125x50x63	10,30 €
1035626	Grana za leplj.m/ž	140x63x75	11,30 €
1035627	Grana za leplj.m/ž	160x63x75	12,40 €
1035507	Grana za leplj.m/ž	200x63x75	13,00 €
1035630	Grana za leplj.m/ž	225x63x75	13,70 €

HOLANDER SA NAVOJEM / THREADED
NIPPLE

Šifra	Opis	Cena
1035574	Holander sa n. Ø 3/8"	2,00 €
1035575	Holander sa n. Ø 1/2"	2,10 €
1035576	Holander sa n. Ø 3/4"	2,50 €
1035578	Holander sa n. Ø 1"	3,20 €
1035579	Holander sa n. Ø 1" ½	3,20 €
1035580	Holander sa n. Ø 2"	4,0 €
1035581	Holander sa n. Ø 2" ½	16,30 €
1035582	Holander sa n. Ø 3"	22,30 €
1035583	Holander sa n. Ø 4"	34,50 €



MATICA / NUT

Šifra	Opis	Cena
1035212	Matica Ø 1"½	6,20 €
1035213	Matica Ø 2"	9,00 €
1035214	Matica Ø 2"½	16,20 €

FITING I CEVI

MODULI za RAZVODNIKE U PVC IN PN 10

Šifra	Opis	Br. izlaza/Outlets		Tipologija/type		Cena
		n. (mm)	n. (mm)	Terminal/End	Centrala /Central	
1036005	Razvodnik Ø90 M	1	1			
		d.50x40	d.50x40	x		29,40 €
1036006	Razvodnik Ø110 M	1	1			
		d.63x50	d.63x50	x		39,10 €
1036007	Razvodnik Ø90 M	0	1			
			d.50x40	x		29,40€
1036008	Razvodnik Ø110 M	0	1			
			d.63x50	x		39,10 €
1036009	Razvodnik Ø90 F	0	1			
			d.50x40	x		29,40€
1036010	Razvodnik Ø110 F	0	1			
			d.63x50	x		39,10 €
1036011	Razvodnik Ø90 F	0	2		F	
			d.50x40			45,00€
1036012	Razvodnik Ø110 F	0	2		F	
			d.63x50			56,70 €
1036013	Razvodnik Ø90 M	0	2		X	
			d.50x40			45,00 €
1036014	Razvodnik Ø110 M	0	2		X	
			d.63x50			54,00 €
1036015	Razvodnik Ø90 M	1	2		X	
		d.63x50	d.50x40			42,80 €
1036016	Razvodnik Ø110 M	1	2		X	
		d.63x50	d.63x50			54,00€
1036017	Razvodnik Ø90 M/F	0	2			
			d.50x40		X	45,00 €
1036018	Razvodnik Ø110 M/F	0	2			
			d.63x50		X	56,70€



cod.1036005 - 1036006



cod. 1036007 - 1036008



cod.1036009 - 1036010



cod. 1036011 - 1036012



cod.1036013 -1036014



cod.1036015 - 1036016



cod.1036017- 1036018

FITING PVC POD PRITISKOM

SPOJNICA POLIETILENE / POLYETHYLENE CONNECTION

Šifra	Opis	Mere	Cena
1035750	Spojnicica PE muški	Ø50 x1"½	9,00 €
1035751	Spojnicica PE muški	Ø 63 x2"	15,50 €
1035754	Spojnicica PE ženski	Ø50 x1"½	9,90 €
1035755	Spojnicica PE ženski	Ø 63 x2"	16,30 €

KOLENO POLIETILENE / POLYETHYLENE ELBOW

Šifra	Opis	Mere	Cena
1035758	Koleno PE muško 90°	Ø 50x1"½	10,20 €
1035759	Koleno PE muško 90°	Ø 63x2"	17,10 €
1035762	Koleno PE žen. 90°	Ø 50x1"½	12,90 €
1035763	Koleno PE žen. 90°	Ø 63x2"	19,50 €



MOBILNI PRSTEN/MOBILERINGNUT

Šifra	Opis	Mere	Cena
1035774	Mobilni prsten PE fem 90° Ø 50 x2"		14,20 €
1035776	Mobilni prsten PE fem 90° Ø 63 x2"		21,40 €

SPOJNICA KOLENA / ELBOW JOINT

Šifra	Opis	Mere	Cena
1035765	Spojnicakoleno PE	Ø 50	16,40 €
1035766	spojnicakolena PE	Ø 63	28,80 €

SPOJNICA TEE / TEE JOINT

Šifra	Opis	Mere	Cena
1035769	Spojnicica tee PE	Ø 50	22,00 €
1035770	Spojnicica tee PE	Ø 63	41,70 €



FITING I CEVI

NEPOVRATNI VENTILI

SA Epoxy oblogom malog gubitka pritiska i epdm dihtunzima, proizvod Danfos Socla.

Epoxy coating with low pressure drops, gaskets epdm, produced by danfos Socla

NEPOVRATNI VENTIL ZA LEPLJENJE / GLUING CHECK VALVE

Šifra / code	Opis /description	Mere	Cena/ price
1035303	Nepovratni ventil PVC za leplj.	Ø 20 mm	51,60 €
1035304	Nepovratni ventil PVC za leplj.	Ø 25 mm	54,80 €
1035305	Nepovratni ventil PVC za leplj.	Ø 32 mm	59,80 €
1035306			
1035307	Nepovratni ventil PVC za leplj.	Ø 63 mm	84,50 €
1035308	Nepovratni ventil PVC za leplj.	Ø 75 mm	228,30 €
1035309	Nepovratni ventil PVC za leplj.	Ø 90 mm	289,40 €



NEPOVRATNI VENTIL OD LIVENOG GVOŽĐA/CAST-IRON CHECKVALVE

Šifra /code	Opis /description	Cena/ price
1035692	Valvole di ritegno in ghisa Ø 100mm	408,30 €
1035693	Valvole di ritegno in ghisa Ø 125mm	669,30 €
1035694	Valvole di ritegno in ghisa Ø 150mm	833,50 €
1035695	Valvole di ritegno in ghisa Ø 200mm	1.479,60 €
1035696	Valvole di ritegno in ghisa Ø 250mm	2.068,30 €

SIGHT GLASS

Šifra / code	Opis/description	Mere	Cena
1035752	Nepovratni ventil prozirni vizir. Ø 50mm		117,20€
1035753	Nepovratni ventil prozirni vizir. Ø 63mm		138,90€
1035746	Nepovratni ventil prozirni vizir. Ø 75mm		168,10 €
1035749	Nepovratni ventil prozirni vizir FI 90mm		401,50 E
1035747	Nepovratni ventil prozirni vizir. Ø 110mm		447,90€
1035748	Nepovratni ventil prozirni vizir. Ø 125mm		540,80€

Šifra	Opis	Mere	Cena/ price
1035301	Clapet ventil	Ø 75 mm	122,20 €
1035323	Clapet ventil	Ø 90 mm	138,20 €
1035324	Clapet ventil	Ø 110 mm	169,20 €
1035325	Clapet ventil	Ø 125 mm	199,60 €
1035327	Clapet ventil	Ø 160 mm	241,90€
1035328	Clapet ventil	Ø 200 mm	292,40€

PRIRUBNICE, ZAPTIVKE, PRSTENJE, ŠRAFOVI, PODLOŠKE ŠELNE



PRIRUBNICA / FLANGE

Šifra	Opis	Cena
1035220	Flanša Ø 63	7,20 €
1035221	Flanša Ø 75	9,90 €
1035222	Flanša Ø 90	11,40 €
1035223	Flanša Ø 110	13,20 €
1035228	Flanša Ø 125	32,90 €
1035225	Flanša Ø 140	34,20 €
1035226	Flanša Ø 160	34,20 €
1035227	Flanša Ø 200	49,40 €
1035229	Flanša Ø 225	52,70 €
1035260	Flanša Ø 250	86,10 €
1035843	Flanša Ø 280	160,90 €
1035261	Flanša Ø 315	181,30 €



SLEPA PRIRUBNICA

1035508	Slepa flanša Ø 110	35,80 €
1035509	Slepa flanša Ø 125	41,40 €
1035904	Slepa flanša Ø 140	48,70 €
1035510	Slepa flanša Ø 160	54,70 €
1035511	Slepa flanša Ø 200	107,20 €
1035524	Slepa flanša Ø 225	107,20 €

ŠRAFI / MATICE /
PODLOŠKE pocinkovane

Šifra / code	Opis /description	Mere	Cena/ price
1035252	Šraf / matica / 2 podloške poc.	16x70	2,40 €
1035253	Šraf / matica / 2 podloške poc	16x100	2,20 €
1035823	Šr. / matica / 2 podl. Poc.	16x120	3,20 €
1035219	Šraf / mat. / 2 podloške poc.	16x140	5,50 €
1035254	Šraf / matica / 2 podloške poc.	16x160	4,80 €
1035255	Šraf / matica / 2 podloške poc.	16x200	6,20 €
1035248	Šraf / matica / 2 podloške inox	16x70	4,20 €
1035249	Šraf / matica / 2 podloške inox	16x100	5,50 €



RAVNA ZAPTIVKA / FLAT SEAL

Šifra	Opis	Cena
1035512	Ravni dihtung Ø 32	0,88 €
1035513	Ravni dihtung Ø 40	1,08 €
1035230	Ravni dihtung Ø 50	1,32 €
1035231	Ravni dihtung Ø 63	1,68 €
1035232	Ravni dihtung Ø 75	1,90 €
1035233	Ravni dihtung Ø 90	3,16 €
1035234	Ravni dihtung Ø 110	4,36 €
1035235	Ravni dihtung Ø 125	5,04 €
1035236	Ravni dihtung Ø 140	6,10 €
1035237	Ravni dihtung Ø 160	8,00 €
1035238	Ravni dihtung Ø 200	11,80 €
1035239	Ravni dihtung Ø 225	13,12 €
1035529	Ravni dihtung Ø 250	29,50 €
1035533	Ravni dihtung Ø 280	80,00 €
1035534	Ravni dihtung Ø 315	89,70 €



PRSTEN / COLLAR

Šifra	Opis	Cena
1035240	Prsten Ø 63	4,80 €
1035241	Prsten Ø 75	7,30 €
1035242	Prsten Ø 90	8,80 €
1035243	Prsten Ø 110	11,70 €
1035244	Prsten Ø 125	25,00 €
1035245	Prsten Ø 140	27,30 €
1035246	Prsten Ø 160	30,70 €
1035247	Prsten Ø 200	59,30 €
1035450	Prsten Ø 225	63,10 €
1035451	Prsten Ø 250	91,60 €
1035840	Prsten Ø 280	183,90 €
1035452	Prsten Ø 315	211,50 €

FITING I CEVI

NEPOVRATNI TIHI VENTIL / SILENT CHECK VALVE



Šifra / code	Opis / description	Mere	Cena / price
1030609	Nepovratni tihi ventil	Ø 50	58,00 €
1030610	Nepovratni tihi ventil	Ø 63	74,00 €

Šipka sa navojem / THREADED BAR

Šifra / code	Opis / description	Misure	Prezzo / price
1035257	Šipka sa navojem	M10 x1000	12,90 €
1035258	Šipka sa navojem	M16 x1000	34,10 €

STEZALJKA BRAVO / BRAVO COLLAR



Šifra / code	Opis / description	MERE	Cena / price
1035460	Stezaljka bravo	Ø 160/75	194,40 €
1035461	Stezaljka bravo	Ø 160/90	194,40 €
1035462	Stezaljka bravo	Ø 160/110	194,40 €
1035463	Stezaljka bravo	Ø 160/125	206,80 €
1035464	Stezaljka bravo	Ø 200/75	219,50 €
1035465	Stezaljka bravo	Ø 200/90	219,50 €
1035466	Stezaljka bravo	Ø 200/110	219,50 €
1035467	Stezaljka bravo	Ø 200/125	231,60 €
1035910	Stezaljka bravo	Ø 225/75	315,00 €
1035911	Stezaljka bravo	Ø 225/90	315,00 €
1035912	Stezaljka bravo	Ø 225/110	315,00 €
1035913	Stezaljka bravo	Ø 225/125	327,40 €
1035468	Stezaljka bravo	Ø 250/75	315,00 €
1035469	Stezaljka bravo	Ø 250/90	315,00 €
1035470	Stezaljka bravo	Ø 250/110	315,00 €
1035471	Stezaljka bravo	Ø 250/125	327,40 €

OBUJMICA / BRACKET SOCKET



Šifra	Opis	Mere	Cena
1035643	Obujmica	Ø 25x1/2"	3,40 €
1035262	Obujmica	Ø 32x1/2"	3,90 €
1035263	Obujmica	Ø 50x1/2"	4,20 €
1036214	Obujmica	Ø 50x3/4"	4,10 €
1036215	Obujmica	Ø 50x1"	5,00 €
1035265	Obujmica	Ø 63x1/2"	10,00 €
1036216	obujmica	Ø 63x3/4"	9,60 €
1036217	Obujmica	Ø 63x1"	9,60 €
1034299	Obujmica	Ø 63x1 1/2"	9,60 €
1035266	Obujmica	Ø 75x1/2"	10,00 €
1034298	Obujmica	Ø 75x1"	12,60 €
1035267	Obujmica	Ø 75x1 1/2"	12,60 €
1035689	Obujmica	Ø 90x1/2"	12,10 €
1035268	Obujmica	Ø 90x1 1/2"	12,60 €
1034297	Obujmica	Ø 90x2"	12,10 €
1035691	Obujmica	Ø 110x1/2"	12,60 €
1034296	Obujmica	Ø 110x1"	12,60 €
1035270	Obujmica	Ø 110x1 1/2"	17,00 €
1035690	Obujmica	Ø 125x1/2"	19,40 €
1035271	Obujmica	Ø 125x1 1/2"	21,80 €
1035272	Obujmica	Ø 125x2"	27,90 €
1035314	Obujmica	Ø 140x1/2"	27,90 €
1035277	Obujmica	Ø 140x1 1/2"	27,90 €
1035796	obujmica	Ø 160x1/2"	33,10
1036213	Obujmica sa	Ø 200x1 1/2"	152,70 €
1035610	Obujmica	Ø 200x2"	152,70 €
1035611	Obujmica	Ø 250x2"	152,70 €
1035424	Obujmica	Ø 315x2"	256,00 €



ANTIVIBRACIONE SPOJNICE SA ČELIČNOM GALVANIZIRANOM FLANŠOM



Šifra / code	Opis / description	Cena / price
1035679	Antivib. spojnica sa čeličnom galvaniziranim flanšom, real.od EPDM DN 80	
1035680	Antivib.spojnica sa čeličnom galvan, flanšom realizovano od EPDM DN 100	
1035681	Antivib.spojnica sa čeličnom galvaniziranim flanšom real.od EPDM DN 125	Na upit
1035682	Antivib.spojnica sa čeličnom galvaniziranim.flanšom real.od EPDM DN 150	
1035683	Antivibraciona spojnica sa čeličnom galvan.flanšom, real. Od EPDM DN 200	
1035684	Antivibr.spojnica sa čeličnom galv.flanšom realizovanom od EPDM DN 250	

NASTAVCI ZA PROTOK TEČNOSTI



Šifra / code	Opis / description	Cena / price
1041320	Nastavak za protok tečnosti Ø 50	89,30 €
1041321	Nastavak za protok tečnosti Ø 63	89,30 €
1041322	Nastavak za protok tečnosti Ø 90	223,40 €
1041323	Nastavak za protok tečnosti Ø 110	289,00 €
1041324	Nastavak za protok tečnosti Ø 125	453,50 €
1041319	Nastavak za protok tečnosti Ø 160	376,70 €

SET KONTROLNI STUB NIVOA KOMPENZACIONE KADE Ø 63

Šifra / code	Opis / description	Cena / price
1041325	Kompletirana sa 2 m providnog creva + 1 mlaznica RL-319 + 1 lakat + T ženska + 1 Kapa ženska + kuglični ventil + 2 ogrlice Complete with 2 m of transparent hose + 1 outlet RL-319-1 + elbow + T female + female cap + ball valve + 2 collars	299,10 €

CEVI PVC



Šifra	Opis			Cena / M
1035330	Cev/tube PVC IDRO-FLEX	Ø 20 mm	U rolni od 25 m	2,20 €
1035334	Cev/tube PVC IDRO-FLEX	Ø 25 mm	U rolni od 25 m	3,10 €
1035331	Cev/tube PVC IDRO-FLEX	Ø 32 mm	U rolni od 25 m	4,60 €
1035332	Cev/tube PVC IDRO-FLEX	Ø 50 mm	U rolni od 25 m	5,50 €
1035416	Cev/tube PVC IDRO-FLEX	Ø 50 mm	U rolni od 50 m	5,50 €
1035333	Cev/tube PVC IDRO-FLEX	Ø 63 mm	U rolni od 25 m	8,50 €
1035415	Cevtube PVC IDRO-FLEX	Ø 75 mm	U rolni od 25 m	16,70 €



CEV PVC FLEKSIBILNI BARRIERFLEXCDSPVC-BARRIERFLEXCDSPVC-FLEXIBLEHOSE

Šifra / code	Opis /description	Mere	Cena/M
1035335	Cev PVC BARRIERFLEX CDS	Ø 50 mm rolne od 25 m	8,80 €
1035487	Cev PVC BARRIERFLEX CDS	Ø 50 mm rolne od 50 m	8,80 €
1035336	Cev PVC BARRIERFLEX CDS	Ø 63 mm rolne od 25 m	10,90 €

Šifra	Opis	Mere	cena / m
1035455	Cev PVC QUADRA POOL	Ø50 mm rolne 30m	9,60 €
1035594	Cev PVC QUADRA POOL preinfilato	Ø50 mm rolne 25m	17,10 €
1035456	Cev PVC QUADRA POOL	Ø63 mm rolne 30m	15,00 €
1035597	Cev PVC QUADRA POOL preinfilato	Ø63 mm rolne 25m	23,30 €

CEV PVC FLEKSIBILNA ZA SPA UREĐAJE - FLEXIBLE PVC HOSE FOR SPA SYSTEMS

Šifra / code	Opis /description	Mere	cena / price
1070822	Cev PVC FLEKSIBILNA SPA	Ø 3/8" al m	3,90 €
600-10732	Cev PVC FLEKSIBILNASPA	Ø 3/4" al m	6,80 €
600-10756	Cev PVC FLEKSIBILNA SPA	Ø 1" al m	9,00 €
600-01946	Cev PVC FLEKSIBILNA SPA	Ø 1-1/2" al m	15,00 €
600-10757	Cev PVC FLEKSIBILNS SPA	Ø 2" al m	19,00 €

FLEKSIBILNA PROVIDNA PVS CEV-TRETMAN I VODA
TRANSPARENTPVCFLEXIBLEHOSE-TREATMENTANDAIR

ŠIFRA / code	Opis /description	Mere	Cena / price
1070513	Provid,cev PVC fleks.	Ø 2mm int. x Ø 4mm est. al m	1,60 €
1070524	Provid.cev PVC fleks.	Ø 3mm int. x Ø 5mm est. al m	2,00 €
1070511	Provid.cev PVC fleks.	Ø 4mm int. x Ø 6mm est. al m	2,40 €
1070514	Provid.cev PVC fleks.	Ø 5mm int. x Ø 8mm est. al m	3,00 €
1070512	Prov.cev PVC fleks.	Ø 8mm int. x Ø 12mm est. al m	4,60 €

POLU TVRDE CEVI OD TEFLONA - TEFLON SEMI-RIGID
HOSES

Šifra / code	Opis /description	Mere	Cena / price
1075108	Polutvrda cev od teflona	Ø 4mm int. x Ø 6mm est. al m	14,80 €
600-10781	Polutvrda ced od teflona	Ø 8mm int. x Ø 10mm est. al m	26,00 €



Šifra / code	Opis /description	Mere	Cena / price
1035604	Metalni ključ	Ø20x75	111,50 €
1035608	Metalni ključ	Ø63x110	154,30 €

CEV PVC TVRDA- ŠIPKE OD6m-od10bar
RIGID PVC PIPE - 6 m bars- 10 bar

Šifra / code	Opis /description	Mere	Cena / price
1035340	Cev PVC tvrda	Ø 20 mm al m	2,70 €
1035341	CevPVC tvrda	Ø 25 mm al m	4,30 €
1035342	Cev PVC tvrda	Ø 32 mm al m	4,30 €
1035343	CevPVC tvrda	Ø 50 mm al m	7,30 €
1035344	Cev PVC tvrda	Ø 63 mm al m	11,40 €
1035345	Cev PVC tvrda	Ø 75 mm al m	16,30 €
1035346	Cev PVC tvrda	Ø 90 mm al m	21,40 €
1035347	Cev PVC tvrda	Ø 110 mm al m	25,90 €
1035348	Cev PVC tvrda	Ø 125 mm al m	33,30 €
1035349	Cev PVC tvrda	Ø 140 mm al m	42,00 €
1035350	Cev PVC Tvrda	Ø 160 mm al m	55,10 €
1035352	Cev PVC tvrda	Ø 180 mm al m	72,90 €
1035351	Cev PVC tvrda	Ø 200 mm al m	85,20 €
1035399	Cev PVC tvrda	Ø 225 mm al m	107,10 €
1035410	Cev PVC tvrda	Ø 250 mm al m	132,90 €
1035411	Cev PVC tvrda	Ø 280 mm po m	176,20 €
1035412	Cev PVC tvrda	Ø 315 mm Po m	212,10 €
1035495	Cev PVC tvrda	Ø 400 mm po m	Na upit
9000040	Cev PVC tvrda providna	Ø 63 mm po m	79,80 €
600-01945	Cev PVC tvrda za SPA 1"	po m	11,20 €
600-01941	Cev PVC tvrda za SPA 1 1/2"	po m	11,20 €
600-01942	Tube PVC tvrda za SPA 2"	po m	17,30 €



ŠELNA CEVI / PIPE CLAMP COLLAR

Šifra / code	Opis /description	Cena / price
1035055	Šelna cevi Ø 50	4,70 €
1035056	Šelna cevi Ø 63	4,90 €
1035057	Šelna cevi Ø 75	5,70 €
1035058	Šelna cevi Ø 90	7,70 €

ŠELNA ZA PLASTIČNU CEV /
COLLAR FOR PLASTIC PIPE

Šifra / code	Opis /description	Cena / price
1035068	Šelna za plastičnu cev40 sa sidrom	6,30 €
1035060	Šelna za plastičnu cev 50 sa sidrom	6,40 €
1035061	Šelna za plastičnu cev 63 sa sidrom	6,80 €
1035062	Šelna za plastičnu cev75 sa sidrom	7,30 €
1035063	Šelna za plastičnu cev 90 sa sidrom	7,40 €
1035064	Šelna za plastičnu cev110 sa sidrom	7,90 €
1035069	Šelna za plastičnu cev125 sa sidrom	9,50 €
1035065	Šelna za plastičnu cev 140 sa sidrom	11,10 €
1035066	Šelna za plastičnu cev160 sa sidrom	11,20 €
1035067	Šelna za plastičnu cev 200 sa sidrom	15,70 €

KOLENA PN16



KOLENO 90° NA LEPLJENJE 90°
GLUING ELBOW

Šifra/ code	Opis/description	Cena/ price
1200017	Koleno 90° za leplj. Ø 20	0,26 €
1200018	Koleno 90° za leplj. Ø 25	0,42 €
1200019	Koleno 90° za leplj. Ø 32	0,74 €
1200020	Koleno 90° za leplj. Ø 50	1,85 €
1200021	Koleno 90° za leplj. Ø 63	3,55 €
1200022	Koleno 90° za leplj. Ø 75	5,60 €
1200016	Koleno 90° za leplj. Ø 90	9,60 €
1200023	Koleno 90° za leplj. Ø 110	16,30 €
1200024	Koleno 90° za leplj. Ø 125	24,80 €
1200025	Koleno 90° za leplj. Ø 160	47,30 €
1200026	Koleno 90° za leplj. Ø 140	31,90 €



KOLENO 45° NA LEPLJENJE 45°
GLUING ELBOW

Šifra/ code	Opis/description	Cena/ price
1200007	Koleno 45° za leplj. Ø 20	0,20 €
1200008	Koleno 45° za leplj. Ø 25	0,30 €
1200000	Koleno 45° za leplj. Ø 32	0,62 €
1200001	Koleno 45° za leplj. Ø 50	1,60 €
1200002	Koleno 45° za leplj. Ø 63	2,80 €
1200003	Koleno 45° za leplj. Ø 75	4,50 €
1200004	Koleno 45° za leplj. Ø 90	7,70 €
1200005	Koleno 45° za leplj. Ø 110	13,00 €
1200009	Koleno 45° za leplj. Ø 125	19,40 €
1200220	Koleno 45° za leplj. Ø 140	26,50 €
1200006	Koleno 45° za leplj. Ø 160	38,20 €



ADAPTE SA spoljnim NAVOJEM
MALE THREADED ADAPTOR

Muški/ code	Opis/description	Mere/size	Cena/ price
1200160	Adapter sa spoljnim nav.	25X20X1/2"	0,26 €
1200161	adapter sa spolj. navoj.	25X32X1"	0,45 €
1200156	adapter sa spolj. navoj.	32X25X3/4"	0,40 €
1200162	adapter sa spolj. navoj.	40X32X1"	0,50 €
1200040	adapter sa spolj.navoj.	50x1"1/2	1,30 €
1200163	adapter sa spolj. navoj.	50X40X1"1/2	1,10 €
1200041	adapter sa spolj. navoj.	63x2"	2,10 €
1200157	adapter sa spolj. navoj.	63X50X1"1/2"	1,70 €
1200158	adapter saspolj. navoj.	63X50X2"	1,80 €
1200159	adapter sa spolj.navoj.	75X63X2"	2,40 €
1200164	adapter sa spolj. navoj.	75X63X2"1/2	2,70 €



ADAPTER SA unutrašnjim NAVOJEM
FEMALE THREADED ADAPTOR

ŠIFRA/ code	OPIS/description	MERE/ size	Cena/ price
1200150	Adapter sa unutr.navoj.	20X1/2"	0,26 €
1200151	adapter sa unutr.navoj.	50X1"1/2	1,55 €
1200152	Adapter sa unutr. navoj.	63X1"1/2	2,00 €
1200153	adapter sa unutr. navoj.	63X2"	2,70 €

SLOBODNE PRIRUBNICE I SPOJEVI



PRIRUBNICE I SPOJEVI NA LEPLJENJE
GLUINGPLAINGASKETANDCOLLAR

Šifra/ code	Opis/description	cena/ price
1200062	Prirubnica i spoj na leplj. Ø 90	10,10
1200060	Prirubnica i spoj na lepljenje. Ø 110	13,10 €
1200061	Prirubnica i spoj na leplj. Ø 125	20,90 €
1200063	Prirubnica i spoj na leplj. Ø 160	29,30 €

KAPE PN16



KAPA NA LEPLJENJE
GLUING END CAP

Šifra/ code	Opis/description	Cena/ price
1200230	Kapa na leplj. Ø20	0,10 €
1200231	Kapa na leplj. Ø 25	0,20 €
1200233	Kapa na leplj. Ø 32	0,35 €
1200081	Kapa na leplj. Ø 50	0,90 €
1200082	Kapa na leplj. Ø 63	1,80 €
1200083	Kapa na leplj. Ø 75	2,50 €
1200084	Kapa na leplj. Ø 90	4,40 €
1200085	Kapa na leplj. Ø 110	7,70 €

T PN16

	T RAČVE NA LEPLJENJE GLUING TEE		
	Šifra/ code	Opis/description	Cena/ price
1200027	T na leplj. Ø 20	0,34 €	
1200028	T na leplj. Ø 25	0,55 €	
1200029	T na leplj. Ø 32	1,00 €	
1200030	T na leplj. Ø 50	2,50 €	
1200031	T na leplj. Ø 63	4,40 €	
1200032	T na leplj. Ø 75	7,40 €	
1200033	T na leplj. Ø 90	12,30 €	
1200034	T na leplj. Ø 110	20,90 €	
1200036	T na leplj. Ø 125	31,20 €	
1200037	Tna leplj.Ø 140	41,70€	
1200035	Tna leplj.Ø 160	57,70€	

	T REDUKOVANI NA LEPLJ. REDUCED GLUING TEE		
	Šifra/ code	Opis/description	Cena/ price
1200049	T reduk. Naleplj. Ø50X32	2,05€	
1200050	T reduk.na leplj .Ø63x50	4,00€	
1200051	T reduk. na leplj. Ø 75x50	6,30 €	
1200052	T reduk. na leplj,Ø 75x63	7,10 €	
1200053	T reduk.na leplj. Ø 90x63	10,80 €	
1200058	T reduk.na leplj. Ø 90x75	12,10 €	
1200056	T reduk.na leplj. Ø 110x63	16,30 €	
1200057	T reduk.na leplj Ø 110x75	17,90 €	
1200054	Trediuk.na leplj.,Ø110x90	20,00€	
1200055	Treduk.naleplj. Ø160x110	52,40€	

HOLANDERI PN16

	HOLANDER NA LEPLJENJE / GLUING COUPLING		
	Šifra/ code	Opis/description	Cena/price
1200076	Holanderr na leplj.Ø 20	0,20€	
1200078	Holander na leplj. Ø 25	0,30 €	
1200077	Holander na leplj. Ø 32	0,40 €	
1200070	Holander na leplj. Ø 50	1,10 €	
1200071	Holander na leplj. Ø 63	1,90 €	
1200072	Holander na leplj. Ø 75	3,10 €	
1200073	Holander na leplj. Ø 90	5,30 €	
1200074	Holander na leplj. Ø 110	9,00 €	
1200075	Holander na leplj. Ø 160	25,30 €	

	REDUKOVANI HOLANDER / REDUCED COUPLING			
	code	Opis/description	size	price
1200080	Reduk.holander na leplj. Ø 63x50	2,00 €		

	HOLANDER SA NAVOJEM ZA LEPLJENJE THREADED GLUING COUPLING			
	Šifra/ code	Opis/description	Mere/ size	Cena/ price
1200045	Holander navoj/leplj.	50X1½"	1,30 €	
1200046	Holander navoj/leplj.	63X2"	2,40 €	

REDUKTORI, PRODORI I OBUJMICE PN16

	REDUKTOR NA LEPLJENJE / GLUING REDUCING			
	Šifra/ code	Opis/description	Mere/size	Cena/ price
1200086	Reduktor Na lepljenje	Ø25X20	0,10 €	
1200087	Reduktor na lepljenje	Ø32X20	0,20 €	
1200088	Reduktor na lepljenje	Ø50X20	0,60 €	
1200089	Reduktor na lepljenje	Ø50X32	0,50 €	
1200090	Reduktor na lepljenje	Ø63x50	0,80 €	
1200091	Reduktor na lepljenje	Ø75X50	1,40 €	
1200092	Reduktor na lepljenje	Ø75X63	1,10 €	
1200093	Reduktor na lepljenje	Ø90X50	2,80 €	
1200094	Reduktor na lepljenje	Ø90X63	2,10 €	
1200095	Reduktor na lepljenje	Ø90X75	1,90 €	
1200099	Reduktor na lepljenje	Ø110X63	4,70 €	
1200096	Reduktor na lepljenje	Ø110X75	3,70 €	
1200097	Reduktor na lepljenje	Ø110X90	3,60 €	
1200098	Reduktor na lepljenje	Ø160X110	10,70 €	

	ZIDNI PRODOR / THROUGH WALL			
	ŠIFRA/ code	Opis/description	Mere/size	Cena/ price
1200171	Zidni prodor	1¼xØ32/40	2,10€	
1200170	Zidni prodor	2"x Ø50/63	4,50 €	
1200172	Zidni prodor	2½"xØ63/75	6,10€	

	OBUJMICA / BRACKET SOCKET			
	ŠIFRA	Opis/description	MERE	CENA
1200136	Obujmica	Ø50x½"	1,40 €	
1200137	Obujmica	Ø63x½"	2,40 €	

SPOJNICE



SPOJNICA ZA LEPLJENJE
GLUING COUPLING

Šifra/ code	Opis/description	Cena/ price
1200014	Spojnicna na lepljenje Ø 20	0,72 €
1200015	Spojnicna na lepljenje Ø 25	1,15 €
1200038	Spojnicna na lepljenje Ø 32	1,60 €
1200010	Spojnicna na lepljenje Ø 50	3,06 €
1200011	Spojnicna na lepljenje Ø 63	5,40 €
1200012	Spojnicna na lepljenje Ø 75	11,50 €
1200013	Spojnicna na lepljenje Ø 90	16,80 €



SPOJNICA SA NAVOJEM
THREADED COUPLING

šifra/ code	Opis/description	Mere/ size	Cena/ price
1200042	Muška spojnicna sa navojem	50x1"½	3,86 €
1200043	Muška spojnicna sa navojem	63x2"	6,90 €

VENTILI



KUGLIČNI VENTIL NA
LEPLJENJE

Šifra/ code	Opis/description	Cena/ price
1200120	Kuglični ventil Ø 20	3,10 €
1200127	Kuglični ventil Ø 25	5,20 €
1200124	Kuglični ventil Ø 32	7,50 €
1200121	Kuglični ventil Ø 50	16,10 €
1200122	Kuglični ventil Ø 63	26,70 €
1200123	Kuglični ventil Ø 75	35,10 €
1200125	Kuglični ventil Ø 90	81,60 €
1200126	Kuglični ventil Ø110	116,60 €
1200200	Kuglični ventil muški/žen. 1"½	13,20 €



NEPOVRATNI VENTIL NA LEPLJENJE
GLUING CHECK VALVE

Šifra/code	Opis/description	Cena/price
1200144	Nepovratni ventil Ø 32	5,90 €
1200140	Nepovratni ventil Ø 50	13,10 €
1200141	Nepovratni ventil Ø 63	20,50 €



CLAPET VENTIL / CLAPET VALVE

Šifra/code	Opis/description	Cena/price
1200211	Clapet ventil Ø90	68,40 €
1200212	Clapet ventil Ø110	83,60 €
1200213	Clapet ventil Ø125	188,10 €
1200214	Clapet ventil Ø140	188,10 €
1200130	Clapet ventil Ø160	205,30 €
1200131	Clapet ventil Ø200	330,70 €
1200132	Clapet ventil Ø225	330,70 €



LEPTIRASTI VENTIL / BUTTERFLY VALVE

Šifra/ code	Opis/description	Cena/ price
1200100	Leptir ventil Ø 63	32,40 €
1200101	Leptir ventil Ø 75	36,90 €
1200102	Leptir ventil Ø 90	48,90 €
1200103	Leptir ventil Ø 110	56,50 €
1200104	Leptir ventil Ø 125	83,90 €
1200105	Leptir ventil Ø 160	124,20 €
1200106	Leptir ventil Ø 200	153,60 €



KOMPLETAN LEPTIR VENTIL
COMPLETE BUTTERFLY VALVE
Mont.sa flanšom, obruči., šraf.dihtunzima
Mountedwithflanges,collars,boltsandgaskets

ŠIFRA/ code	OPIS/description	Cena/ price
1200110	Leptir ventil Ø 63	59,20 €
1200111	Leptir ventil Ø 75	68,00 €
1200112	Leptir ventil Ø 90	95,00 €
1200113	Leptir ventil Ø 110	110,70 €
1200116	Leptir ventil Ø 125	143,50 €
1200117	Leptir ventil Ø 140	179,10 €
1200114	Leptir ventil Ø 160	245,60 €
1200115	Leptir ventil Ø 200	348,20 €



DONJI VENTIL / FOOT VALVE

Šifra/ code	Opis/description	Cena/ price
1200190	Donji ventil Ø 50	9,70 €
1200191	Donji ventil Ø 63	10,10 €
1200192	Donji ventil Ø 90	40,30 €
1200193	Donji ventil Ø 110	66,10 €
1200194	Donji ventil Ø 160	151,90 €
1200195	Donji ventil Ø 200*	347,20 €

*ventil Ø160 sa priključkom za flanšu od Ø200

OBRUČI



OBRUČI / COLLAR

Šifra/ code	Opis/description	Cena/ price
1200180	Obruč za cev Ø 50	0,44 €
1200181	Obruč za cev Ø 63	0,70 €

LEPILA I ZAPTIVAČI ZA FITING ADHESIVES AND SEALANTS FOR CONNECTIONS

Proizvodi za popravku cevi od PVC. / Products for the repair of PVC piping.



cod. 1036238



cod.1036231



cod.1036232



cod.1036233



cod. 1036234



cod. 1035376

Šifra / code	Opis /description	Cena/ price
1035376	Poliuretanski ketridž –brza penaml.750 Polyurethane cartridge	22,20 €
1035377	Ketridž zaptivač neutro/beloml.300 Sealant cartridge neutral/whiteml.300	20,00 €
1036231	Traka P.T.F.E. profesional - h. 12 mm x 12 m x 0,2 mm P.T.F.E. professional tape - h. 12 mm x 12 m x 0,2 mm	3,00 €
1036232	EPOSTIXepoksidni dvokomponentni lepak- pakovanje 50 g EPOSTIX bicomponent epoxy mastic - case 50 g	15,00 €
1036233	ELASTUKzaptivaču trakamapreformirane -8x15x490mmx4file ELESTUKsealantinpreformedstrips-8x15x490mmx4lines	13,20 €
1036234	ELASTUK STRIP profilisani gips u preformiranim trakama -rolnama h.15 mmx 2mmx 22,5m/ELASTUKSTRIPprofiledplasterinpreformedstrips-rollh.15mm x2mm x 22,5 m	43,90 €
1036238	FASTOPPOOLSamozaptivni protiv gubitka vode - kanister 10 l FASTOP POOL self-sealing to eliminate water leaks - tank 10 l	707,00 €

PODMAZIVAČ MAGIC LUBE / MAGIC LUBE LUBRICANT



Il "MAGIC LUBE 631" je vrhunski podmazivač za korišćenje na metalima, gumi i plastici. Na bazi teflona, otporan na hlorisanu vodu, štiti gumene spojeve i omogućava odvijanje bez napora.

The "MAGIC LUBE 631" is a lubricant higher compatible for use with metals, rubber and plastics. Ateflon based, water-resistant chlorinated, protects the rubber joints and allows you to unscrew them effortlessly.

Šifra/ code	Opis/description	Cena/price
1035382	Podmazivač Magic Lube tuba od 140 gr / Lubrificant, 140 gr	25,10 €

TEČNOST PROTIV CURENJA / LEAK-OFF FLUID



Ova tečnost omogućava, kada se pomeša sa vodom bazena, da parcijalno ili u potpunosti onemogući sitna curenja vode do koje može doći u prekrivkama ili u sastavima cevi. Na isti način zatvara male pukotine u betonu i smoli. 1 litra omogućava tretmane protiv curenja u redu od 500 do 800 litara dnevno za jedan bazen od 50 do 60 m³. Proizvod je biorastvoriv i bez efekata na kupaće i na prirodu.

This liquid when it is mixed with water of a bath tub, allows partially or completely to close the small water leaks that may occur in a coating or pipe fittings. Closes in the same way the small cracks in the concrete and in the resin. 1 liters enable treatment of the losses in the order of 500 to 800 liters per day for a swimming pool from 50 to 60 m³. The product is biodegradable and no effect on bathers and nature.

Šifra/ code	Opis/description	Cena/ price
1035380	Leak Sealer – Tampon tečnost za sitna curenja 1 l / Leak Sealer - Buffer liquid of small leaks 1 l	58,60 €

LEPAK, TEFLON I SREDSTVO ZA ODMAŠĆIVANJE
ADHESIVES, TEFLON AND PICKLING

LEPAK TANGIT

- ZA cevi i fitting od tvrdog PVC : stvara hemijski var na delovima gde je nanet.
- Za fleksibilne cevi: plave boje, brzo hvata, idealan za popravke.

KERALASTIC

Lepljenje na zid i pod pločica ,materijale od kamena, mozaik, itd. na: košuljice, drvo,metal i PVC sa poboljšanim reaktivnim lepilom.

KERALASTIC T

Zidno i podno lepljenje keramičkih pločica, kameni materijali, mozaik, itd. na: košuljici, drvetu, metalu i PVC sa reaktivnim poboljšanim lepilom. Otporan na klizanje.

- 5 kg u sastavu: 4,7 kg/m²komponenta A + 0,3 kg/m² Komponenta B.

GLUE TANGIT

- For rigid PVC pipes and fittings: Make a chemical welding of the supports on which it is applied.
- Hose: blue, quick drying, ideal for making repairs.

KERALASTIC

Wall and floor bonding of ceramic tiles, stone material, mosaic, etc. to: screeds, wood, metal and PVC with improved reactive adhesive.

KERALASTIC T

Wall and floor bonding of ceramic tiles, stone material, mosaic, etc. to: screeds, wood, metal and PVC with improved reactive adhesive. Slip-resistant.

- 5 kg consisting of: 4.7 kg/m² component A + 0.3 kg/ m² component B.



Šifra / code	Opis /description	cena/price
1035362	Lepak POOL-TITE - 125g / POOL-TITE glue - 125g	19,60 €
1035363	Lepak POOL-TITE - 250g / POOL-TITE glue - 250g	26,80 €
1035381	Lepak POOL-TITE - 500g / POOL-TITE glue - 500g	38,10 €
1035364	Tuba lepka TANGIT za cevi PVC - 125 g / TANGIT tube of glue for PVC pipe - 125 g	17,20 €
1035365	Tegla lepka TANGIT za cevi PVC - 250 g sa četkicom TANGIT pot of glue for PVC pipe - 250 g brush	27,70 €
1035366	Tegla lepka TANGIT za cevi PVC - 500 g sa četkicom TANGIT pot of glue for PVC pipe - 500 g brush	52,70 €
1035409	Tegla lepka TANGIT za cevi PVC - 1 kg sa četkicom TANGIT pot of glue for PVC pipe - 1 kg brush	87,90 €
1035367	Tegla odmašćivača TANGIT REINIGER - 1 litar / TANGIT REINIGER pickling jar - 1 liter	45,90 €
1035379	TANGIT zaptivač metalnih spojeva - 50 ml / TANGIT metal sealant - 50 ml	57,50 €
1035371	TANGIT Uni-lock žica zaptivna spojeva- 80 m / TANGIT uni-lock sealant wire - 80 m	30,00 €
1035408	Tuba lepka TANGIT PVC-U PLUS 125 g / TANGIT tube of glue PVC-U PLUS 125 g	17,20 €
1035368	Rolna teflon 12 m standard Facot / Roll of teflon12 m standard Facot	1,40 €
1035369	Rolna traka profesionalna -15 m / Professional roll tape -15 m	14,30 €
1050965	Bikomponentni lepak Keralastic – tegla od 5kg / Keralastic two-component adhesive - 5kg tin	178,80 €
1050966	Bikomponentni lepak Keralastic T – tegla od 5kg / Keralastic two-component adhesive - 5kg tin	178,80 €

LEPILA, DETERDŽENTI I ZAPTIVAČI / ADHESIVES, CLEANERS AND SEALANTS

PVC GEL E WDF 05

Lepak fixotropični (ne kaplje) za PVC tvrdi i fleksibilni brzog delovanja za lepljenje cevi, mufova i fittinga od PVC tvrdoga. Idealana za sisteme pod pritiskom, ispusta ili drenaže. Za prečnike do 250mm, pritisak do 16 bara

PVC CLEANER

Deturdžent za čišćenje, odmašćivanje i površinsku pripremu cevi, mufova i fittinga i ABS pre lepljenja.

KOLMAT FIBRE SEAL

Zaptivna traka univerzalna za spajanje svog fittinga sa navojem metalnog i ili sintetičkog materijala

ACQUA MAX

Lepak za montažu i zaptivač otporan na vodu i na razređivače. Pogodan za sve vrste aplikacija unutar i oko bazena.

LEPAK SUPER PROVIDAN

Lepak na univerzalni dodir izuzetno jak i providan za cerade PVC, može se koristiti i kao termo lepak.

SFT-101 REPAIR

Autoaglomerantna traka silikonska, za poravku gubitka pritiska do 12 bar, i električne izolacije do 15.000 volt, otpornost do 260°C

SILICONENVET

Mazivo silikonske baze otporan na hemijske proizvode, rđu i koroziju. vodonepropustiv i voodootporan

HBS 200 TAPE

Traka za popravke (hitne) univerzalna, elastico i nepropustljiv na vazduh i vodu. Za Drvo, beton, kamen, metal, cink itd.

OBRAĐA CEVI

Za obradu cevi od PVC, PVC-C, ABS, PP e PE. Pogodan za cevi Ø 16-63 mm.

ŽIČANA ŠEGA

Izvanredna za rezanje cevi i sintetičkog materijala. Idealana za cevi smeštenih na teško pristupnim mestima. Za cevi od PVC, PVC-C, PP e PE

PVC GEL AND WDF 05

Thixotropic (non-sagging) quick-setting adhesive for rigid and flexible PVC for bonding rigid PVC pipes, sleeves and fittings. Ideal for pressure, drainage or drainage systems. For diameters up to 250 mm, pressure up to 16 bar

PVC CLEANER

Detergent for cleaning, degreasing and surface preparation of pipes, sleeves and fittings and ABS before gluing

KOLMAT FIBRE SEAL

Universal sealing tape for joining all metal and/or synthetic threaded fittings.

ACQUA MAX

Water and solvent resistant assembly adhesive and sealant. Suitable for all types of applications in and around the pool.

SUPER TRANSPARENT GLUE

Super strong and transparent universal contact adhesive for PVC sheeting, also suitable as a thermo adhesive.

SFT-101 REPAIR

Silicone self-amalgamating tape, for repairing pressure leaks up to 12 bar, and electrical insulation up to 15.000 volts, withstands up to 260°C

SILICONENVET

Silicone-based lubricant resistant to chemicals, rust and corrosion. Water-repellent and water-resistant

HBS 200 TAPE

Universal (emergency) repair tape, elastic and impermeable to air and water. Can be used on wood, concrete, stone, metal, zinc etc.

PIPE SMOOTH

For beveling PVC, PVC-C, ABS, PP and PE pipes. Suitable for pipes Ø 16-63mm.

WIRE SAW

Perfect for cutting pipes made of synthetic material. Ideal for pipes located in hard-to-reach places. For PVC, PVC-C, PP and PE pipes.



Šifra /code	Opis /description	Cena/price
1050950	PVC GEL tuba 125 ml/PVC GEL tube 125 ml	6,90 €
1050951	PVC GEL bočica 250 ml/PVC GEL bottle 250 ml	11,90 €
1050952	PVC GEL bočica 500 ml/PVC GEL bottle 500 ml	21,10 €
1050953	PVC GEL bočica 1000 ml/PVC GEL bottle 1000 ml	33,30 €
1050954	WDF-05 bočica 250 ml/WDF-05 bottle 250 ml	17,00 €
1050955	WDF-05 bočica 500 ml/WDF-05 bottle 500 ml	29,10 €
1050957	PVC Cleaner limenka 250 ml/PVC Cleaner tin 250 ml	17,80 €
1050958	PVC Cleaner limenka 1000 ml/PVC Cleaner tin 1000 ml	33,20 €
1050959	Traka Kolmat Fibre Seal 12 mm x 15 mm/Kolmat Fibre Seal tape 12 mm x 15 mm	14,80 €
1050960	Aqua Max uložak 425 g/Aqua Max cartridge 425 g	28,60 €
1050961	Kontakt lepak Super providni 5L/Super Clear Contact Glue 5L	189,00 €
1050962	Kontakt lepak Super providni 1,8L/Super Clear Contact Glue 1.8L	114,60 €
1050963	Traka SFT-101 Repair/SFT-101 Repair Tape	31,10 €
1050964	SILICONENVET Silikonska mast 125g/SILICONENVET Silicone grease 125g	23,70 €
1050917	Žičana šega BL.1/ Wire saw BL.1	21,30 €
1050918	HBS 200 Lepljiva traka / HBS 200 Adhesive Tape	29,60 €
1050919	Obrada cevi / cable saw	237,90 €

Merlino

YOUR PERSONAL SIDEKICK FOR
SWIMMING POOL MANAGEMENT

TI SE RELAKSIRAJ NA
BAZEN ĆE ON PAZITI



*LIČNI POMOĆNIK ZA
KONTROLU BAZENA I
OPREME*



**Konekcija WI-FI za jednostavno upravljanje
preko tvog telefona**

WI-FI direct connection for easy
management via your phone



**Konekcija preko APP
Radi upravljanja bazenom
I sa daljine**

Connection via APP to manage
the pool remotely



Upravlјati bazenom, gde god da si, nikada nije bilo jednostavnije.

Managing your pool, wherever you are, has never been easier.

Merlino jeste inovativni daljinski sistem koji omogućava, putem app, koju preuzimaš na smart phone ili tablet, tretman vode, filtriranje, zagrevanje, rasvetu bazena, programirajući ih za jednu pametnu i učinkovitu upotrebu. Jedno green, tehnološko i praktično rešenje, koje omogućava optimalnu potrošnju vode i struje svog bazena, pretvarajući ga u jedan **eko-održiv sistem**.

Potpuno autonoman, Merlino zahvaljujući serveru cloud, omogućava **kontrolu** u svakom delu sveta, putem konekcije internet, **svih funkcija i podataka bazena**, primajući obaveštenja u slučaju eventualnih nepravilnosti.

Merlino is the innovative automation system it allows you to control, through an app that can be downloaded to your smartphone or tablet, the water treatment, filtration, heating, and lighting of your pool, programming them for smart, high-performance use. A green, technological and practical solution that allows you to optimize the water and electricity consumption of your pool, transforming it into an eco-sustainable system. Completely autonomous, Merlino thanks to the cloud server, allows you to monitor anywhere in the world, via internet connection, all the functions and data of the pool, receiving notifications in case of any imbalances.

MERLINO I PROIZVODI SMART MERLINO AND SMART PRODUCT

Merlino može da upravlja proizvodnim asortimanom C.P.A., od **pumpe podesive brzine Serena** do **reflektora Real** i da se konektuje sa **toplotnim pumpama Indiana Evo**. Jednostavnost upotrebe putem APP olakšava upravljanjem parametara, optimizirajući potrošnju i garantujući visoke standarde kvaliteta vode. **Sa Merlino usavršavanje i ušteda su zagarantovani.**

Merlino can manage products from the C.P.A. range, from the Serena variable speed pump to Real fixtures, and connect with Indiana Evo heat pumps. Ease of use via APP facilitates parameter management, optimizing consumption and ensuring high water quality standards. With Merlino optimization and savings are guaranteed.



Filtracija
filtration
Pumpa Serena



Rasveta
lighting
Reflektor Real



Grejanje
heating
Pumpa Indiana Evo-V



Tretman
treatment
Clorox i dozirna pumpa

PREDNOSTI MERLINA : THE ADVANTAGES OF MERLINO :

- Kompletan nadzor bazena direktno sa svog mobilnog telefona
- Upravljanje bazenom i sa daljine autonomno putem besplatne App za IOS i Android
- Ecoodrživ, smanjuje potrošnju energije i hemijskih proizvoda
- Sve funkcije i podaci bazena su na raspolaganju, uvek i daleko od kuće
- Upozorenja putem alarma u slučaju eventualnih problema
- Sigurno korišćenje bazena, personalizovajući tajmere parametara vode

- Complete pool monitoring directly from your mobile phone
- Manage your pool remotely via free App for IOS and Android
- Environmentally friendly, reducing energy consumption and chemicals
- All pool functions and data at your fingertips, always, even away from home
- Alerts via alarms in the event of any problems
- Use the pool safely by customising timers linked to water parameters



**PREUZMI
APP**
Na Android i iOS

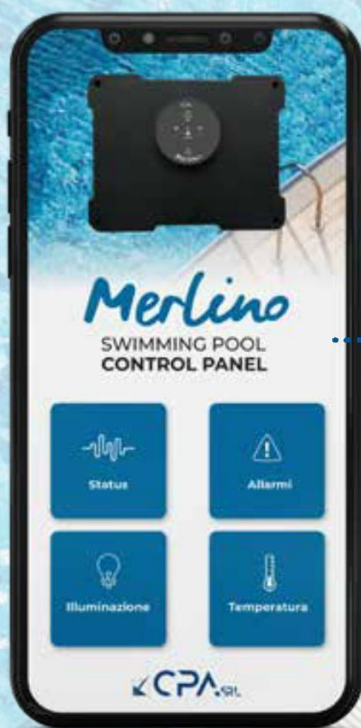

**Nadzor i upravljanje
parametrima
Bazena u realnom vremenu**
*Real-time monitoring
and management of pool
parameters*



**Konekcija WI-FI za jednostavno
upravljanje
svojom telefonom**

WI-FI direct connection for easy
management via your phone



**Konekcija CLOUD
putem APP za upravljanje
bazenom i sa razdaljine**

Connection via APP to manage the
pool remotely

GLAVNE FUNKCIJE MERLINA: MERLINO MAIN FEATURES:

Jednostavnim dodirom **APP Merlino moguće je kontrolisati:**



Rasvetu: moguće je programirati paljenje reflektora, upravljati bojama, kreirati preset, paliti ih u ritmu muzike!



Filtracija: kontrola vremena filtracije sa mogućnošću postavljanja timer personalizovanih i za godišnja doba kontrolisajući do 4 pumpe (jedna ili podesiva brzina)



Temperaturu: moguće je nadzirati konstantno temperaturu u bazenu. Sa našim toplotnim pumpama namenski proučenim, moguće je rashladiti i/ili zagrejati vodu i produžiti tako period korišćenja bazena.



Hidromasaža: jednostavnom komandom moguće je uroniti u beskraj mehurića Programirajući trenutke čistog uživanja.



Dezinfekcija: Omogućena je provera značajnih vrednosti parametara vode da bi se predupredili eventualni problemi garantujući uvek savršenu vodu.



Alarmi: Upozorenje svaki put kad se desi neki alarm. Npr ako se potroše hemijska sredstva, ako se spusti nivo vode kompenzacionog rezervoara ili se mnogo podigne, ecc.

With a simple tap in the Merlino APP, you can control: Lighting: you can program the lights to turn on, manage colorations, create a preset, turn them on to music! Filtration: control of filtration times with the ability to set custom timers even by season controlling up to 4 pumps (single or variable speed); Temperature: you will be able to constantly monitor the temperature of the water in the pool. With our specially designed heat pumps, you can cool and/or heat the water and thus extend the period of use of the pool; Whirlpool: With a simple control you can immerse yourself in an infinity of bubbles by programming moments of pure well-being; Disinfection: It will be possible to check the value of significant water parameters so you can prevent any problems and ensure perfect water at all times; Alarms: Alert whenever an alarm should be generated. For example, if they run out of chemicals, if the level in the compensation tank should drop or rise too much, etc.



COMFORT
COMFORT



ZDRAVLJE
HEALTH

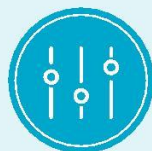

KONTROLA
CHECK



UŠTEDA
SAVINGS



EFIKASNOST
EFFICIENCY

OPREMA I VERZIJE MERLINA: FEATURES AND VERSIONS OF MERLINO:

- Modulo Hidro: 4 relejna izlaza za paralelno ili individualno upravljanje hidromasažnim uređajima
- Senzor protoka i temperature
- Modul za kontrolu baterije povratnog ispiranja sa 5 elektroventila: vremenska automatizacija povratnog ispiranja filtera
- Moduli kontrole maksimalne struje : opcionalni dodatak do dodatna 3 zaštitna modula sa kontrolom struje osim onoga isporučenog u osnovnoj isporuci
- Kontrola parametara vode: merenje i kontrola pH-Rx e T, ili pH-Cl e T, upravljajući preko, relèja, dozirnomo opremom/tretmanom kao što su npr elektropumpe ili elektrolitski generatori, sa sensorima nivoa za signalizaciju isteka proizvoda.
- Konekcija Cloud: kontrola i daljinsko upravljanje Merlinom namenskom APP
- Hydro module: 4 relay outputs for managing hydromassage devices in parallel or individually
- Flow and temperature sensor
- Backwash battery control module with 5 electro-actuated valves: timed automation of the backwash of the filter(s)
- Maximum current control cards: optional addition of up to 3 other protection cards with current control in addition to the one supplied in the basic version
- Water parameter control: measures and controls pH-Rx and T, or pH-Cl and T, piloting, via relay, the dosing/treatment devices such as electric pumps or electrolytic generators, with level sensors for signaling the end product.
- Cloud connection: remote monitoring and management of Merlino via dedicated APP

STANDARDNE KONFIGURACIJE STANDARD CONFIGURATIONS

Šifra/ code	Opis /description	Cena/ price
MERLINO APP BY PHONE		
1040066	Tabla Merlino APP by Phone do 2 HP monofazna / Merlino APP by Phone panel up to 2 HP single-phase	1.395,00 €
1040073	Tabla Merlino APP by Phone 1 pumpa 3 HP monofazna / Merlino APP by Phone panel 1 pump 3 HP single-phase	1.735,00 €
1040074	Tabla Merlino APP by Phone 1 pumpa do 2 HP trofazna / Merlino APP by Phone panel 1 pump up to 2 HP three-phase	1.875,00 €
1040075	Tabla Merlino APP by Phone 1 pumpa 3 HP trofazna / Merlino APP by Phone panel 1 pump 3 HP three-phase	1.859,00 €
MERLINO APP BY CLOUD		
1040067	Tabla Merlino APP & Cloud by Phone kontrola na daljinu / Merlino panel APP & Cloud by Phone remotely controlled	1.919,00 €
1040068	Tabla Merlino APP & Cloud by Phone, modul Dos Chem pH/Rx /Merlino panel APP & Cloud by Phone Dos Chem pH/Rx module	2.459,00 €
1040071	Tabla Merlino APP & Cloud by Phone, modul Dos Chem pH/Cl / Merlino panel APP & Cloud by Phone Dos Chem pH/Cl module	2.460,00 €
1040070	Tabla Merlino APP & Cloud by Phone, modul komanda na baterije a 5 valvole /Merlino panel APP & Cloud by Phone, 5-valve backwash battery control module	3.629,00 €

E KSPANZIJE EXPANSIONS

MODULI - MODULES



Šifra /code	Opis /description	cena/price
1040072	Modul daljinske konekcije Wi-fi sa antenom/Wi-fi remote connection module with antenna	580,00 €
600-30210	Modul ekspanzije zaštita motore/Engine protection expansion module	64,00 €

MODULI EKSPANZIJE - EXPANSIONS BOX



Šifra /code	Opis /description	Napon/ Voltage	Cena/price
1040600	Ekspanziona kutija Snage: 1 pumpa od 3 HP 230V/ Power Expansion Box: 1 pump 3 HP 230V	230	340,00 €
1040601	Ekspanziona kutija Snage: 2 pumpe od 3 HP 230V/ Power Expansion Box: 2 x 3 HP 230V pumps	230	488,00 €
1040602	Ekspanziona kutija snage: 3 pumpe od 3 HP 230V/ Power Expansion Box: 3 HP 230V pumps	230	776,00 €
1040603	Ekspanziona kutija snage: 1 pumpa od 0,5-0,75 HP 400V/ Power Expansion Box: 1 pump 0.5-0.75 HP 400V	400	480,00 €
1040604	Ekspanziona kutija snage: 1 pumpa od 1-2 HP 400V/ Power Expansion Box: 1 pump 1-2 HP 400V	400	480,00 €
1040605	Ekspanziona kutija snage: 1 pumpa od 3 HP 400V/ Power Expansion Box: 1 x 3 HP 400V pump	400	464,00 €
1040606	Ekspanziona kutija snage 1 pUmpa da 4-5,5 HP 400V/ Power Expansion Box: 1 pump 4-5.5 HP 400V	400	444,00 €
1040607	Ekspanziona kutija snage: 2 Pumpe da 0,5-0,75 HP 400V/ Power Expansion Box: 2 pumps 0.5-0.75 HP 400V	400	768,00 €
1040608	Ekspanziona kutija snage: 2 pumpe da 1-2 HP 400V/ Power Expansion Box: 2 x 1-2 HP 400V pumps	400	732,00 €
1040609	Ekspanziona kutija snage: 2 pumpe da 3 HP 400V/ Power Expansion Box: 2 x 3 HP 400V pumps	400	772,00 €
1040610	Ekspanziona kutija snage: 2 pumpe da 4 HP 400V/ Power Expansion Box: 2 x 4 HP 400V pumps	400	732,00 €
1040611	Ekspanziona kutija snage: 2 pumpe da 5,5 HP 400V/ Power Expansion Box: 2 x 5.5 HP 400V pumps	400	736,00 €
1040612	Ekspanziona kutija snage: 3 pumpe da 0,5-0,75 HP 400V/ Power Expansion Box: 3 pumps 0.5-0.75 HP 400V	400	896,00 €
1040613	Ekspanziona kutija Snage: 3 pumpe da 1-2 HP 400V/ Power Expansion Box: 3 pumps of 1-2 HP 400V	400	892,00 €
1040614	Ekspanziona kutija Snage: 3 pumpe da 3 HP 400V/ Power Expansion Box: 3 HP 400V pumps	400	948,00 €
1040615	Ekspanziona kutija di snage: 3 pumpe da 4 HP 400V/ Power Expansion Box: 3 pumps of 4 HP 400V	400	900,00 €
1040616	Ekspanziona kutija snage 3 pumpe da 5,5 HP 400V/ Power Expansion Box: 3 pumps 5.5 HP 400V	400	900,00 €

MODULI EKSPANZIONI HIDRO - HYDRO EXPANSION MODULES

Šifra /code	Opis /description	Napon/ Voltage	Cena/ price
1040617	Ekspanziona kutija HIDRO 2 DISP. 230 MONO - 0,75 & 0,9 kW	230	811,50 €
1040618	EKSPANZIONA HIDRO 2 DISP. 230 MONO - 1,5 & 1,5 kW	230	811,60 €
1040619	EKSPANZIONA kutija HIDRO 2 DISP. 230 MONO - 2,2 & 1,5 kW	230	811,60 €
1040620	Ekspanziona kutija HIDRO 2 DISP. 400 TRI - 0,75 & 0,9 kW	400	986,50 €
1040621	Ekspanziona Kutija HIDRO 2 DISP. 400 TRI - 1,5 & 1,5 kW	400	986,50 €
1040622	Ekspanziona Kutija HIDRO 2 DISP. 400 TRI - 2,2 & 2,2 kW	400	986,50 €
1040623	Ekspanziona kutija HIDRO 2 DISP. 400 TRI - 2,9 & 2,2 kW	400	986,50 €
1040624	Ekspanziona kutija HIDRO 4 DISP. 230 MONO - 0,75 & 0,9 kW	230	1.253,20 €
1040625	Ekspanziona kutija HIDRO 4 DISP. 230 MONO - 1,5 kW	230	1.253,20 €
1040626	Ekspanziona kutija HIDRO 4 DISP. 230 MONO - 2,2 & 1,5 kW	230	1.253,20 €
1040627	Ekspanziona kutija HIDRO 4 DISP. 400 TRI - 0,75 & 0,9 kW	400	1.478,40 €
1040628	Ekspanziona kutijaHIDRO 4 DISP. 400 TRI - 1,5 kW	400	1.478,40 €
1040629	Ekspanziona kutijaHIDRO 4 DISP. 400 TRI - 2,2 kW	400	1.478,40 €
1040630	Ekspanziona kutija HIDRO 4 DISP. 400 TRI - 2,9 & 2,2 kW	400	1.478,40 €

OPREMA ACCESSORIES

ULAZNI SENZORI - INPUT SENSORS



Šifra /code	Opis /description	Cena/price
1091148	Senzor nivoa skimera sa kablom 10 m / Float skimmer sensor with 10 m cable	49,10 €
1091150	Sonde nivoa (3 pz.) / Float level switch (3 pcs.)	93,60 €
1091151	Senzor protoka sa sondom temperature (1/2") / Paddle flow switch with temperature sensor (1/2")	198,50 €
1075142	Sonda pH - kablo 5 m preč. 5 mm - per pompe dosaggio / pH probe-dosing pump	108,00 €
1075145	Sonda Rx + kablo 5 m preč. 5 mm - per pompe per dosaggio/ Redox probe-dosing pump	108,00 €
1075178	Amperometrična ćelija slobodni hlor, bez senzora protoka / Amperometric cell free chlorine, without flow sensor	1.300,30 €

TRANSFORMATOR ZA SVETLA - TRANSFORMER FOR LIGHTS



Šifra/code	Opis /description	Cena/price
1090395	Transformator duple izolacije 12V ac - 100 VA/Trasformer with double insulation 12V ac - 100 VA	93,60 €
1090396	Transformator duple izolacije 12V ac- 200 VA/Trasformer with double insulation 12V ac - 200 VA	108,00 €

ELEKTROVENTIL ZA PUNJENJE - LOAD SOLENOID VALVE



Šifra /code	Opis /description	cena/price
1041331	Elektroventil 1" sa regulatorom protoka 24 VDC/Solenoid valve 1" with flow 24 VDC	74,60 €
1041332	Elektroventil 1 1/2" sa regulatorom protoka 24 VDC/Solenoid valve 1 1/2" with flow 24 VDC	162,90 €
1041333	Elektroventil 2" sa regulatorom protoka 24 VDC/Solenoid valve 2" with flow 24 VDC	181,40 €

SET DOZIRNIH PUMPI - DOSING PUMP KIT



Šifra /code	Opis /description	Cena/price
1075192	Set 2 pumpe peristaltičke sa dve sonde nivoa / Peristaltic pumps Kit with level probe	310,00 €
1075193	Set 2 pumpe elektromagnetne sa sondama nivoa / Electromagnetic pumps Kit with level probe	736,60 €

OPREMA ZA DOZIRANJE - DOSING ACCESSORIES



Šifra / code	Opis /description	Cena/ price
1035263	Obujmica Ø 50x1/2" / bracket socket	4,20 €
1035265	Obujmica Ø 63x1/2" / bracket socket	10,00 €
1035266	Obujmica Ø 75x1/2" / bracket socket	10,00 €
1035689	Obujmica Ø 90x1/2" / bracket socket	12,10 €
1075177	Sonda površine sa plovkom kablo od 3 m / Level probe with 3 m cable	40,00 €
600-02456	Držač površinske sonde / Level probe bracket	3,90 €
1075139	Nosač sonde PH/RX 1/2" / Probe holder PH/RX 1/2"	11,50 €
1075159	Ventil brizgaljka 1/2" PP za peristaltičke pumpe/ Injection valve 1/2" PP for peristaltic pumps	15,50 €
1075174	Ventil brizgaljka 1/2" PP za elektromagnente pumpe/ Injection valve 1/2" PP for electromagnetic pumps	9,30 €
1075160	Ventil brizgaljka 1/2" PVDF - spec. per dosaggio cloro / Injection valve 1/2 " PVDF-dosing Cl	23,40 €
1075156	Podni filter / Filter bottom	13,30 €
1070511	Providna cev od PVC fleksibilnog - Ø 4 mm int. x Ø 6 mm est./flexible PVC transparent hose - al m	2,40 €
1091144	Nosač senzora nivoa skimera skimmer / Skimmer level sensor support	38,20 €
1091145	Set nosača senzora površine skimera / Skimmer level sensor support kit	85,00 €

SET OPREME ZA OČITAVANJE I HEMIJSKO DOZIRANJE ACCESSORY KIT READING AND CHEMICAL DOSING

I kit comprendono: sonda, valvola d'iniezione, porta sonda, presa a staffa, sonda di livello, filtro di fondo, soluzione tampone e tubi flessibili.



Šifra / code	Opis /description	Cena/ price
1040088	Set opreme Merlino za doziranje pH/Merlino accessory kit for pH dosage	206,80 €
1040089	Set opreme Merlino za doziranje Rx/Merlino accessory kit for Rx dosage	220,00 €

SET UNAPRED SASTAVLJEN NA PANELU MERLINO - MERLIN PANEL PRE-ASSEMBLED KIT



Šifra/code	Opis /description	Cena/price
1040076	Set unapred-sastavljen na panelu Merlino pH-R -Peristaltiche/Pre-assembled kit on Merlino pH-Rx panel - Peristaltic	3.333,00 €
1040078	Set unapred-sastavljen na panelu Merlino pH-Rx -Elettromagnetiche/Pre-assembled kit on Merlino pH-Rx panel - Electromagnetic	3.808,00 €
1040079	Set unapred-sastavljen na panelu Merlino pH-Cl -Peristaltiche/Pre-assembled kit on Merlino pH-Cl panel - Peristaltic	4.665,00 €
1040080	Set unapred sastavljen na panelu Merlino pH-Cl-Elettromagnetni/Pre-assembled kit on Merlino pH-Cl panel - Electromagnetic	5.139,00 €

TABLA POOL CONTROL / POOL CONTROL ELECTRIC PANEL



- Vodootporna kutija od ABS belog IP65 sa providnim poklopcem
- Daljinski prekidač snage pumpe (jedan za svaku pumpu)
- Timer pumpe/filteri pokretni neizostavni sa rezervnim punjenjem 200 sati
- Zaštitni relej podesivi (jedan za svaku pumpu)
- Ručni birač ili automatski pumpe filtera (jedan za svaku pumpu)
- Automatski prekidač zaštite linije reflektora 16A
- Junction box in white ABS with transparent cover, IP65
- Contactor power pump (one for each pump)
- Timer pump / filter with power reserve 200 hours
- Protection adjustable circuit breaker (one for each pump)
- Manual or automatic switch for pump filter (one for each pump)
- Automatic security to protect lights line 16A

ELEKTRIČNA TABLA+ 1 PUMPA + SIGURNOSNI PREKIDAČ + UTIČNICA SCHUKO ZA TRANSFORMATOR REFLEKTORA (BEZ SIGURNOSNOG PREKIDAČA) / ELECTRIC PANEL FOR 1 PUMP + LIFE SAVING + SCHUKO SOCKET FOR LIGHT TRANSFORMER (WITHOUT LIFE SUPPORT)

Šifra monofaze/ code monophase	Šifra trifaze/ code threephase	Opis/description	cena monofazna/ price monophase	cena trofazni/price threephase
1090600	-	Električna tabla za jednu pumpu 0,5 - 0,75 HP	363,10 €	-
	1090601	Električna table za jednu pumpu 0,75 - 1 HP	-	442,40 €
1090602	-	Električna tabla za jednu pumpu 1 - 1,5 HP	409,00 €	-
	1090603	Električna tabla za jednu pumpu 1,5 - 2 HP	-	442,40 €
1090612	-	Električna tabla za jednu pumpu 2 - 2,5 HP	507,60 €	-
	1090605	Električna tabla za jednu pumpu 3 HP	-	442,40 €
1090604	-	Električna tabla za jednu pumpu 3 HP	533,20 €	-

**ELEKTRIČNA TABLA 1 PUMPA + PRIMARNO KABLO 2M + UTIKAČ 16A CE + KABLO PUMPE 1,5M + UTIČNICA SCHUKO ZA TRANSFORMATORE REFLEKTORA (BEZ SIGURNOSNOG PREKIDAČA)
ELECTRIC PANEL FOR 1 PUMP + PRIMARY 2 M CABLE + PLUG 16 AEC+PUMP CABLE 1,5 M + SCHUKO SOCKET FOR LIGHT TRANSFORMER (WITHOUT LIFE SUPPORT)**

Šifra monofazne/ code monophase	Šifra trofazne/ code threephase	Opis/description	Cena monofazne/ price monophase	Cena trofazne/ price threephase
1090606	-	Električna tabla za jednu pumpu 0,5 - 0,75 HP	413,20 €	-
-	1090607	Električna tabla za jednu pumpu 0,75 - 1 HP	-	473,00 €
1090608	-	Električna tabla za jednu pumpu 1 - 1,5 HP	413,20 €	-
-	1090609	Električna tabla za jednu pumpu 1,5 - 2 HP	-	473,00 €
1090610	-	Električna tabla za jednu pumpu 2 - 2,5 HP	537,90 €	-
-	1090611	Električna tabla za jednu pumpu 2,5- 3 HP	-	473,00 €
1090614	-	Električna tabla za jednu pumpu 3 HP	606,70 €	-

**ELEKTRIČNA TABLA 2 PUMPE + SALVAVITA + PRESA SCHUKO PER TRASFORMATORE FARI (BEZ SIGURNOSNOG PREKIDAČA)
ELECTRIC PANEL FOR 2 ELECTRIC PUMPS + LIFE SAVING + SCHUKO SOCKET FOR LIGHT TRANSFORMER (WITHOUT LIFE SUPPORT)**

Šifra monofaze/ code monophase	Šifra trifaze/ code threephase	Opis/description	Cena monofaze/ price monophase	Cena trifaze/price threephase
1090630	-	Električna tabla za dve pumpe 0,5 - 0,75 HP	668,80 €	-
-	1090631	Električna tabla za dve pumpe 0,5 HP	-	726,70 €
-	1090633	Električna tabla za dve pumpe 0,75 - 1 HP	-	726,70 €
1090624	-	Električna tabla za dve pumpe 1 - 1,5 HP	674,80 €	-
-	1090627	Električna tabla za dve pumpe 1,5 - 2 HP	-	726,70 €
1090626	-	Električna tabla za dve pumpe 2 - 2,5 HP	929,30 €	-
1090628	1090629	Električna tabla za dve pumpe 2,5 - 3 HP	979,40 €	726,70 €

**ELEKTRIČNA TABLA 2 PUMPE + PRIMARNO KABLO 2M + UTIKAČ 16A CE
+ KABLO PUMPE 1,5M + UTIČNICA SCHUKO ZA TRANSFORMATOR REFLEKTORA (BEZ SIGURNOSNOG PREKIDAČA)**
**ELECTRIC PANEL FOR 2 PUMPS + PRIMARY 2 M CABLE + PLUG 16 AEC+PUMP CABLE 1,5 M +
SCHUKO SOCKET FOR LIGHT TRANSFORMER (WITHOUT LIFE SUPPORT)**



Šifra monofaze/ code monophase	Šifra trifazne/ code threephase	Opis/description	Cena monofaze/ price monophase	Cena trifazne/ price threephase
1090636	-	Električna tabla za dve pumpe 0,5 - 0,75 HP Rif.4104	716,60 €	-
1090642	-	Električna tabla za dve pumpe 1 - 1,5 HP Rif.4105	945,90 €	-
-	1090643	Električna tabla za dve pumpe 0,5 HP Rif.4112	-	826,50 €
-	1090637	Električna tabla za dve pumpe 0,75 - 1 HP Rif.4113	-	826,50 €
1090644	-	Električna tabla za dve pumpe 2 - 2,5 HP Rif.4106	974,60 €	-
-	1090645	Električna tabla za dve pumpe 1,5 - 2 HP Rif.4114	-	826,50 €
1090646	-	Električna tabla za dve pumpe 3 HP Rif.4107	1.079,70 €	-
-	1090647	Električna tabla za dve pumpe 2,5 - 3 HP Rif.4115	-	826,50 €

**ELEKTRIČNA TABLA 3 PUMPE + SIGURNOSNI PREKIDAČ + UTIČNICA SCHUKO ZA TRANSFORMATOR REFLEKTORA
(BEZ SIGURNOSNOG PREKIDAČA)**
**ELECTRIC PANEL FOR 3 ELECTRIC PUMPS + LIFE SAVING + SCHUKO SOCKET FOR LIGHT
TRANSFORMER (WITHOUT LIFE SUPPORT)**



Šifra monofaze/ code monophase	Šifra trifazne/ code threephase	Opis/description	Cena monofaze/ price monophase	Cena trifaze/ price threephase
1090665	-	Električna tabla za tri pumpe 0,5 - 0,75 HP	1.246,90 €	-
-	1090668	Električna tabla za tri pumpe 0,5 - 1 HP	-	2.030,40 €
1090666	-	Električna tabla za tri pumpe 1 - 1,5 HP	1.246,90 €	-
-	1090669	Električna tabla za tri pumpe 1,5 - 2 HP	-	2.030,40 €
1090667	-	Električna tabla za tri pumpe 2 - 2,5 HP	1.318,60 €	-
-	1090670	Električna tabla za tri pumpe 2,5 - 3 HP	-	2.030,40 €

**KOMANDNA TABLA SA PNEUMATSKIM TRANSDUKTOROM
POOL CONTROL WITH PNEUMATIC TRANSDUCER**



KOMANDNA TABLA ZA 1 APARAT / CONTROL PANEL FOR 1 EQUIPMENT

- Nepromočiva kutija u ABS bela IP65 sa providnim poklopcem
- Daljinski prekidač snage pumpe
- Birač ručni/automatski pumpe
- Transduktor pneumatski on-off montiran na električnoj tabli
- Bez prekidača spasitelja
- Junction box with white ABS with transparent cover, IP65
- Contacteur power pump
- Switch for manual/automatic pump
- On-off pneumatic transducer mounted on the panel
- Without lifesaving

Šifra monofaze/ code monophase	Šifra trifaze/ code threephase	Opis/description	Cena monofaze/ price monophase	Cena trifaze/ price threephase
1040013	1040014	Komandna tabla 0,75/1,1kW(1/1,5 HP) Pool Control 0,75/1,1kW(1/1,5 HP)	348,80 €	422,80 €
1040015	1040016	Komandna tabla 1,5/2,2kW (2/3 HP) Pool Control 1,5/2,2kW (2/3 HP)	474,40 €	422,80 €
-	1040004	Komandna tabla 4/5,5kW (5,5/7,5 HP) Pool Control 4/5,5kW (5,5/7,5 HP)	-	422,80 €

KOMANDNA TABLA ZA DVA APARATA / CONTROL PANEL FOR 2 EQUIPMENTS

- Pogodan za zone hidromasaže ili vodenih igara
- Za upravljanje 1 pumpom i 1 duvaljkom ili sa 2 Uređaja istovremeno
- Bez sigurnosnog prekidača
- 1 transduktor pneumatski
- Suitable for spa areas or water games
- To control 1 pump and 1 blower or 2 devices
- Without lifesaving
- 1 pneumatic transducer

Šifra monofaze/ code monophase	Šifra trifaze/code threephase	Opis/description	Cena monofaze/price monophase	Cena trifaze/price threephase
1091089	-	Komandna tabla 2 uređaja 0,75/1,1kW(1/1,5 HP)+ 0,9 kW Pool Control 2 devices 0,75/1,1kW(1/1,5 HP)+ 0,9 Kw	527,90 €	-
-	1091093	Komandna tabla 2 uređaja 1,1/1,5kW(1,5/2 HP)+ 0,9 kW Pool Control 2 devices 1,1/1,5kW(1,5/2 HP)+ 0,9 kW	-	612,00 €
1091090	1091094	Komandna tabla 2 uređaja 1,1/1,5kW(1,5/2 HP)+ 1,1/1,5 kW Pool Control 2 devices 1,1/1,5kW(1,5/2 HP)+ 1,1/1,5 kW	527,90 €	612,00 €
1091091	1091095	Komandna tabla 2 uređaja 2,2kW(3 HP) + 1,1/1,5 kW Pool Control 2 devices 2,2kW(3 HP) + 1,1/1,5 kW	688,00 €	612,00 €
1091092	1091096	Komandna tabla 2 uređaja 2,2kW(3 HP) + 2,2 kW Pool Control 2 devices 2,2kW(3 HP)+ 2,2 kW	821,70 €	612,00 €
-	1091098	Komandna tabla 2 uređaja 3kW (4 HP) + 1,1/1,5 kW Pool Control 2 devices 3kW (4 HP) + 1,1/1,5 kW	-	501,60 €

Šifra /code	Opis /description	Cena/price
1091147	Razvodna kutija pneumatskiprekidač / pneumatic button derivation	42,10 €

KOMANDNA TABLA HIDROMASAŽA SA PREKIDAČEM PIEZOELEKTRIČNIM
POOL CONTROL HYDROMASSAGE WITH PIEZOELECTRIC BUTTON

KOMANDNA TABLA 1 PUMPA VERZIJA ON-OFF / CONTROL PANEL 1 PUMP ON-OFF VERSION

Šifra monofaze/ code monophase	Šifra trifaze/ code threephase	Opis/description	Cena monofaze/ price monophase	Cena trifaze/price threephase
1090671	1090673	Komandna tabla 0,55/0,75kW (0,75/1 HP)/Pool control 0,55/0,75kW (0,75/1 HP)	612,00 €	664,20 €
1090672	1090674	Komandna tabla 1,1/1,5kW (1,5/2 HP) Pool control 1,1/1,5kW (1,5/2 HP)	604,40 €	664,20 €
-	1090675	Komandna tabla 2,2kW (3 HP) Pool control 2,2kW (3 HP)	-	664,20 €
-	1090676	Komandna tabla 2,9/4kW (4/5,5 HP) Pool control 2,9/4kW (4/5,5 HP)	-	664,20 €

KOMANDNA TABLA 2 PUMPE VERSIONE ON-OFF - 1 PREKIDAČ / CONTROL PANEL 2 PUMPS ON-OFF VERSION

Šifra monofaze/ code monophase	Šifra trifaze/ code threephase	Opis/description	Cena monofaze/ price monophase	Cena trifaze/price threephase
1090677	1090681	Komandna tabla 0,55/0,75kW (0,75/1 HP) + 0,9 kW Pool control 0,55/0,75kW (0,75/1 HP) + 0,9 kW	710,40 €	860,30 €
1090678	1090682	Komandna tabla 1,1/1,5kW (1,5/2 HP) + 1,2/1,5 kW Pool control 1,1/1,5kW (1,5/2 HP) + 1,2/1,5 kW	710,40 €	860,30 €
1090679	1090683	Komandna tabla 2,2kW (3 HP) + 2,2 kW Pool control 2,2kW (3 HP) + 2,2 kW	798,10 €	860,30 €
1090680	1090684	Komandna tabla 2,9kW (4/HP) + 2,2 kW Pool control 2,9kW (4 HP) + 2,2 kW	825,80 €	860,30 €

KOMANDNA TABLA 1 PUMPA VREMENSKA VERZIJA / CONTROL PANEL 1 PUMP TIMED VERSION

Šifra monofaze/ code monophase	Šifra trifaze/code threephase	Opis/description	Cena monofaze/price monophase	Cena trifaze/price threephase
1090685	1090687	Komandna tabla 0,55/0,75kW (0,75/1 HP) Pool control 0,55/0,75kW (0,75/1 HP)	825,80 €	885,70 €
1090686	1090688	Komandna tabla 1,1/1,5kW (1,5/2 HP) Pool control 1,1/1,5kW (1,5/2 HP)	825,80 €	885,70 €
1090760	1090689	Komandna tabla 2,2kW (3 HP) Pool control 2,2kW (3 HP)	960,70 €	885,70 €
-	1090690	Komandna tabla 2,9/4kW (4/5,5 HP) Pool control 2,9/4kW (4/5,5 HP)	-	885,70 €

KOMANDNA TABLA 2 PUMPE VREMENSKA VERZIJA - 1 PREKIDAČ / CONTROL PANEL 2 PUMPS TIMED VERSION

Šifra monofaze/ code monophase	Šifra trifaze/code threephase	Opis/description	cena monofaze/ price monophase	Cena trifaze/price threephase
1090691	1090695	Quadro di comando 0,55/0,75kW (0,75/1 HP) + 0,9 kW Pool control 0,55/0,75kW (0,75/1 HP) + 0,9 kW	964,20 €	1.084,20 €
1090692	1090696	Quadro di comando 1,1/1,5kW (1,5/2 HP) + 1,2/1,5 kW Pool control 1,1/1,5kW (1,5/2 HP) + 1,2/1,5 kW	964,20 €	1.084,20 €
1090693	1090697	Quadro di comando 2,2kW (3 HP) + 2,2 kW Pool control 2,2kW (3 HP) + 2,2 kW	1.019,60 €	1.084,20 €
1090694	1090698	Quadro di comando 2,9kW (4/HP) + 2,2 kW Pool control 2,9kW (4 HP) + 2,2 kW	1.051,90 €	1.084,20 €

GEL ISOLANTE / GELBOX



Nema više štete na električnim uređajima i svetlima sa GELBOX, gel kutija za višekratnu upotrebu koji efiksano štiti konektore od vlage i vode. Spreman za upotrebu, netoksičan i bez roka isteka, GELBOX je pogodan za jedan konektor i kablo do 3x6mm². Idealan za zaptivanje konekcionih kutija sa stepenom zaštite IP68, GELBOX saobrazan je električnim zahtevima standarda EN 50393.

No more damage to electrical systems and lights with GELBOX, a reusable gel box that effectively protects the connectors from moisture and water. Ready to use, non-toxic and with no expiration date, GELBOX is suitable for a connector and a cable up to 3x6mm². Ideal for sealing connection boxes with an IP68 degree of protection, GELBOX complies with the electrical requirements of the EN 50393 standard.

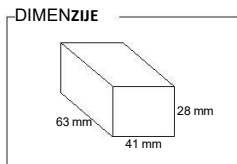

Otpornost na UV zrake
Temperatura rada: <90°C
Temperatura instalacije: -40°C/+50°C

Šifra /code	Opis /description	Cena/price
9030120	Gelbox - gel Izolaciona kutija za kablo 3x6mm ²	20,10 €

KUTIJA ZA REGULISANJE NIVOVA / LEVEL CONTROL PANELS



LEVELONE

Elektronska tabla za regulisanje nivoa Skimer bazena putem senzora I/ili za korpicu

LEVELONE

electronic regulation level for skimmer pool by I/O sensor for basket.

Za kontrolnu elektronsku integrisanu tablu sa upravljanjem nivoa videti: / For the electronic control and regulations levels see the product:

MERLINO



Cod.1041330

Šifra /code	Opis /description	Cena/price
1090512	LevelOne tabla regulacije nivoa za skimmer bazen LevelOne regulation level for skimmer pool	695,00 €
1041330	Modul sonda nivoa vode sa 3 elektrodama za prelivne bazene Water level sensor module with 3 electrodes for overflow pools	401,80 €

TRANSFORMATORI / TRANSFORMERS



Toroidni sigurnosni transformator
U nepromočivom kućištu
waterproof safety toroidal
transformer



Trasformatore in cassetta bianco
con interruttore ON/OFF
Transformer in white box
with ON/OFF



Transformator u kutiji sa
prekidačem za blokiranje vrata

Transformer in enclosure with door
interlock switch

ŠIFRA / code	Opis /description	Cena/ price
Singl transformator/Single transformer		
1090380	Singl torični transformator 230/12 V da 300 VA/ Single transformer	133,20 €
1090381	230/12 V da 630 VA/ Single transformer	198,00 €
Sigurnosni toroidni transformator u nepromočivom kućištu/waterproof safety toroidal transformer		
1090395	Transformator duple izolacije 12 VAC-100 VA /Trasformer double insulation	93,60 €
1090396	Transformator duple izolacije 12 VAC-200 VA /Trasformer double insulation	108,00 €
Transformator u kutiji beli sa prekidačem ON/OFF, utičnica schuko i Stege I vodica kabla za reflektor/Transformer in White box with ON / OFF, and terminal schuko plug and a grommet for headlamp		
1090393	Transformator u kutiji prekidača on/off 100 VA/ Trasformer in box	138,00 €
1090382	Transformator u kutiji prekidača on/off 300 VA/ Trasformer in box	180,00 €
1090383	Transformator u kutiji prekidača on/off 600 VA/ Trasformer in box	270,00 €
1090384	Transformator ukutiji prekidača on/off 900 VA/ Trasformer in box	450,00 €
Transformator u kutiji sa prekidačem za blokiranje vrata, utičnica schuko i steznici I vodica kabla za reflektor/Transformer in enclosure with door interlock switch, terminals, schuko plug and a grommet for headlamp		
1090394	Transformator u kutiji prekidača za blokiranje vrata 100 VA/ Trasformer in box	234,00 €
1090385	Transformator u kutiji prekidača za blokiranje vrata c 300 VA/ Trasformer in box	396,00 €
1090386	Transformator u kutiji prekidača za blokiranje vrata 600 VA/ Trasformer in box	475,20 €
1090387	Transformator u kutiji prekidača za blokiranje vrata 900 VA/ Trasformer in box	648,00 €
Separacioni transformator u kutiji sa prekidačem i stegama za uređaje za protivstrujno plivanje i hidromasažu/Isolation transformer in a box with switch and terminal facilities for swimming and hydro		
1090388	Transformator separacije 2500 VA monofaze/Isolation Trasformer	CENA NA UPIT
1090389	Transformator separacije 2500 VA trifaze/Isolation Trasformer	
1090390	Transformator separacije 3500 VA trifaze/Isolation Trasformer	

OPREMA
ACCESSORIES

Šifra/code	Opis /description	Cena/price
DNEVNI ČASOVNIK / DAILY CLOCK		
1090430	Dnevni časovnik 1 ROM 1 DR 230 V 1 modul / Daily clock 230V 1 module	77,90 €

Technical Bunkers

MAŠINSKE PROSTORIJE



4



Sadržaj

LOCALI TECNICI / TECHNICAL BUNKERS

- 234 MAC 6
- 234 POZZETTO SPA
- 235 BIG MAC
- 236 ARCO
- 237 SEDICI
- 238 KIWI
- 239 GARDEN
- 240 ROC
- 241 COMODO
- 242 BELBO
- 243 HELLIO
- 244 GLOBO
- 245 MASTER
- 246 ATLANTIC

FILTER ZID/ WALL FILTER

- 247 IKARUS E APOLLO

POSTOLJA MONOBLOK/ MONOBLOCK BASES

- 248 POSTOLJE BOX 65/75 / BOX 65/75 BASE
- 249 PRIKLJUČCI I FITING ZA MAŠINSKE PROSTORIJE / CONNECTIONS AND FITTINGS FOR TECH. BUNKERS

MAŠINSKE PROSTORIJE - TECHNICAL BUNKERS



POZZETTO SPA

KARAKTERISTIKE | Features

dimenzije(cm) 97 x 56 x 59
 dimension(cm)
 Korisna zapremina nom.. 0,25 m³
 težina 10 kg



MAC 6

KARAKTERISTIKE | Features

dimenzije(cm) 97 x 56 x 80
 dimension (cm)
 Korisna zapremina nom. 0,35 m³
 težina 12 kg

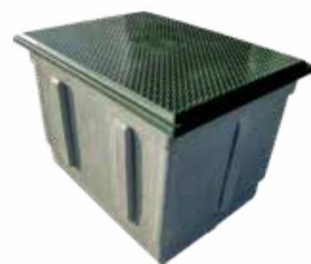

BIG MAC

KARAKTERISTIKE | Features

dimenzije(cm) 118 x 91 x 83
 dimension(cm)
 Korisna zapremina nom. 0,60 m³
 težina 20 kg



ARCO

KARAKTERISTIKE | Features

dimenzije(cm) 115,5x93,5h.94 cm
 dimension(cm)
 korisna zapremina nom. 0,95 m³
 težina weight 45kg



SEDICI

KARAKTERISTIKE | Features

dimenzije (cm) 137 x 112 x 80
 dimension (cm)
 Korisna zapremina nom. 0,70 m³
 težina weight 36 kg



KIWI

KARAKTERISTIKE | Features

dimenzije(cm) 113x113x100
 dimension(cm)
 Korisna zapremina nom. 1,03 m³
 težina weight 30kg



GARDEN

KARAKTERISTIKE | Features

dimenzije(cm) 140x 114x 66
 dimension(cm)
 Korisna zapremina nomi. useful volume 0,90 m³
 težina weight 40kg



ROC

KARAKTERISTIKE | Features

dimenzije(cm) 151 x 134 x 65/80
 dimension (cm)
 korisna zapremina nomi. useful volume 1,30/1,60 m³
 težina weight 115 kg



COMODO

KARAKTERISTIKE | Features

dimenzije (cm) 163 x 130 x 102/135
 dimension (cm)
 korisna zapremina nomi. useful volume 1,50/2,00 m³
 težina weight 67/80 kg



BELBO

KARAKTERISTIKE | Features

dimenzije (cm) dimension (cm)	158 x 108 x 100
Korisna zapremina Nomin.	1,50 m ³
težina weight	60 kg



HELLIO

KARAKTERISTIKE | Features

dimenzije (cm) dimension (cm)	224 x 155 x 115
Korisna zapremina nom.	3,00 m ³
težina weight	122 kg



GLOBO

KARAKTERISTIKE | Features

dimenzije (cm) dimension (cm)	224 x 189 x 114
Korisna zapremina nom.	3,5 m ³
nomi. useful volume težina weight	144 kg



ATLANTIC

KARAKTERISTIKE | Features

dimenzije (cm) dimension (cm)	246 x 236 x 160
Korisna zapremina nom.	7,00 m ³
težina weight	250 kg



MASTER

KARAKTERISTIKE | Features

dimenzije (cm) dimension (cm)	224 x 189 x 160
korisna zapremina nom.	5,00 m ³
težina weight	200 kg

MURO FILTRANTE



IKARUS E APOLLO

KARAKTERISTIKE | Features

dimenzije (cm) dimension (cm)	100 x 25 x 120/150
Korisna zapremina nom.	0,60 - 0,80 m ³
težina weight	60-90 kg

**POSTOLJA
ZA MONOBLOK
BASE FOR MONOBLOCK**



BOX 65/75

KARAKTERISTIKE | Features

dimenzije (cm) dimension (cm)	149 x 90 x 149
Ø max filtro filter max ø	650 o 750 mm

POZZETTO SPA



Prostori u fibreglasuu kompletu sa šarkama i sigurnosnim poklopcem. Sve naše mašinske prostorije se mogu personalizovati i imaju poklopce sa protivkliznom površinom. Verzija "uključiti utičnicu" isporučuje se sa razvdonom kutijom, spojnicama za pumpu, kablovskim propustom i 2 metra spoljnog kabla sa utičnicom po zakonskim propisima. Svi uređaji su ispitani pod pritiskom.

Fiberglass housings complete with hinges and locking security. All our technical bunkers can be customized and are equipped with covers with slip-resistant surface. The version of "attaching the plug" is delivered with electrical panel, fittings to the pump, cable gland and 2 linear meters of external cable complete with plug according to law. All systems are tested under pressure.

Prostorija osmišljena da bi se smestila jedna hidromasažna pumpa, jedan kompresor blower (kako za privatnu upotrebu tako i ,za kompresore od livenog gvožđa, za kontinuiranu upotrebu) i tablu sa pneumatskim pretvaračem. Pogodan i za smeštaj pumpi za protivstrujno plivanje. Isporučuje se prazan ili kompletan sa uređajima.

Technical bunkers designed to accommodate a tub pump, a blower (both for private and continuous use cast iron blowers) and an electric panel with pneumatic transducer. It is also suitable for housing counter-current swimming pumps. It is supplied empty or complete with equipment.

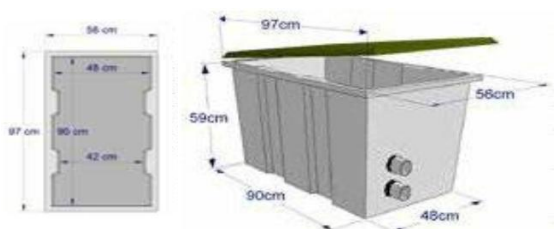

Šifra/code	Opis/description	Cena/price
1010001	Pozzetto SPA ukopan prazann sa poklopcem/Empty basement sump SPA with cap	735,00 €
1010002	Poklopac za Pozzetto SPA/MAC 2 - zamena/Lid for well SPA/MAC2 - replacement	311,50 €

Šifra monofazni	Šifra trofazn.	Opis	Cena monofazni	Cena trifase	
1010004	1010240	SPA m3/h 22 sa pumpom ARCA 1500A, ploča sa pneumatskim pretvaračem-	Samo voda	1.857,00 €	1.807,00 €
1010029	1010241	SPA m3/h 40 sa pumpom ARCA 2200, ploča sa pneumatskim pretvaračem	samo voda	2.205,00 €	2.121,00 €
1010018	1010242	SPA sa aluminijumskim kompresorom 1,50 kW, ploča sa pneumatskim pretvaračem	samo voda	2.618,00 €	2.422,00 €
1010016	1010243	SPA m3/h 22 con pompa ARCA 1500A, blower 900 W, quadro trasd. pneum.	voda/ vazduh	2.521,00 €	2.618,00 €
1010015	1010244	SPA m3/h 40 con pompa ARCA 2200, blower 900 W, quadro trasd. pneum.	acqua/ aria	2.814,00 €	2.955,00 €

MAC 6

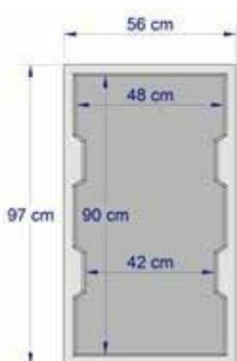

Prostor kompletan sa šarkama i sigurnosnom bravom, isporučen prazan ili već opremljen. Može primiti pumpu i filter do 6m3/h. Isporučka mašinske prostorije **ne sadrži pesak filtera.**

*Technical bunkers equipped with hinge and safety lock. It is delivered empty or already assembled. It can accommodate pump and filter up to 6 m³/h. **The Technicalbunkersprovisiondoesnotincludethesandofthefilter.***



Šifra/Code	Opis/Description	Cena/Price
1010951	Mac 6 ukopan prazan sa poklopcem Mac 6 basement empty with lid	779,50 €
1010002	Poklopac za pozzetto SPA/MAC 6 – zamena za Lid for well SPA / MAC6 - replacement	311,50 €

Šifra monofaza	Šifra trofazn.	Opis	Asp.		Mand.		Vena monofase	Cena trifaze
			N°	ø	N°	ø		
1010950	-	Mac6TOP400-6m ³ /hsa filterom PANAMATOP400,pumpaBRETON370S	1	50	1	50	1.826,00 €	-

BIG MAC



Prostor kompletan sa šarkama i sigurnosnom bravom, isporučen prazan ili već opremljen. Može primiti pumpu i filter do 12 m³/h, kako na kvarcni pesak tako i sa ketridžem.

Isporuka mašinske prostorije ne sadrži pesak filtera.

*Technical bunkers equipped with hinge and safety lock. It is delivered empty or already assembled. It can accommodate pump and filter up to 12 m³/h, both quartz-sand and cartridge. **The technical bunkers provision does not include the sand of the filter.***

Šifra/ Code	Opis/Description	Cena/ Price
1010005	Big Mac ukopan prazan sa poklopcem Big Mac basement empty with lid	1.092,00 €
1010006	Poklopac za Big Mac - zamena / Lid for Big Mac- replacement	435,60 €

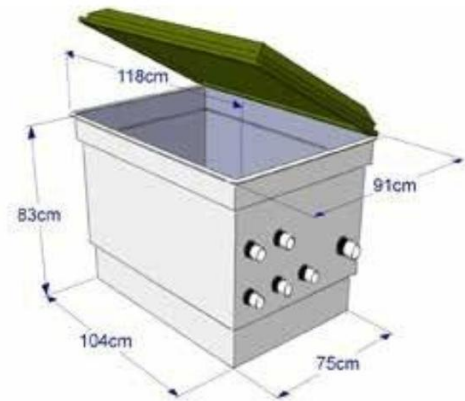

Šifra mono-fase	Šifra trifase	Opis	Asp.		Mand.		Cena monofase	Cena trifase
			N°	ø	N°	ø		
1010009	1010010	Big Mac SIDE 500 - 9 m ³ /h Sa filterom PANAMASIDE500, pa BRETON 550S	2	50	1	50	2.195,00 €	2.190,00 €
1010027	1010028	Big Mac SIDE 500 - 9 m ³ /h Sa filterom RIVALTASIDE500, a AMBRA 75 pumpa AMBRA 75	2	50	1	50	2.691,00 €	2.685,00 €
1010400	1010401	Big Mac SIDE 500 - 9 m ³ /h SA filter MEDITERRANEO SIDE500 , pompa AMBRA 75	2	50	1	50	2.639,00 €	2.633,00 €
1010075	1010076	Big Mac SIDE 600 - 13,5 m ³ /h Sa filt. RIVALTASIDE600, pompa a AMBRA 100	3	50	2	50	3.022,00 €	3.020,00 €
Šifra mono-fase	Šifra trifase	Verzija uključujući utičnicu kompletna sa razvodnom kutijom i elektr. postrojenjem "Plug and play" Version with electrical panel*	Asp.		Mand.		Cena monofase	Cena trifase
			N°	ø	N°	ø		
1010252	1010253	Big Mac SIDE 500 - 9 m ³ /h con filtro PANAMASIDE500, pompa BRETON 550S, quadrolett.	2	50	1	50	2.622,00 €	2.913,00 €
1010256	1010257	Big Mac SIDE 500 - 9 m ³ /h con filtro RIVALTASIDE500, pompa AMBRA 75, quadrolett.	2	50	1	50	3.118,00 €	3.173,00 €
1010402	1010403	Big Mac SIDE 500 - 9 m ³ /h con filtro MEDITERRANEO SIDE500, pompa AMBRA 75, quadrolett.	2	50	1	50	3.066,00 €	3.121,00 €
1010258	1010259	Big Mac SIDE 600 - 13,5 m ³ /h con filtro RIVALTA SIDE 600, pompa AMBRA 100, quadro elett.	3	50	2	50	3.380,00 €	3.436,00 €

*Razvodna kutija nema zaštitu života / *The electrical panel is not provided of lifesaving



ARCO



Mašinska prostorija od PE opremljena predispozicijom odvoda kondenzata, unapred postavljene šarke, brava, ojačana zaptivna ivica. Smeštena je pumpa i filter do 16 mc/h. Isporučen u verziji "uključiti utičnicu" u sastavu je i razvodna kutija. Isporučka mašinske prostorije ne sadrži pesak filtera.

Technical bunkers in PE equipped with condensation discharge, preassembled hinge, safety lock and reinforced board. It supports a pump and a filter up to 16 m³/h. Delivered in the "connected-plug" version is complete with electric panel. **The technical bunkers provision does not include the sand of the filter.**

Šifra/Code	Opis/Descrizione	Cena/Price
1010679	Arco prazna sa poklopcem Arco empty with lid	758,00 €

Šifra monofazne	Šifra trifaze	Opis	Asp.		Mand.		Cena monofaze	Cena trifaze
			N°	ø	N°	ø		
1010683	-	Arco - 6 m3/h sa filterom PANAMA TOP 400, pumpa BRETON 370S	2	50	1	50	1.761,00 €	-
1010684	1010685	Arco - 9 m3/h sa filterom PANAMA SIDE 500, pumpa BRETON 550S	2	50	1	50	1.800,00 €	1.794,00 €
1010653	1010654	Arco-9 m3/h sa filterom MEDITERRANEOSIDE500, pumpa AMBRA75	2	50	1	50	2.244,00 €	2.737,00 €
1010651	1010652	Arco - 9 m3/h filter RIVALTA SIDE 500, pumpa BRETON 550S	2	50	1	50	1.962,00 €	1.957,00 €
1010686	1010687	Arco - 9 m3/h filter RIVALTA SIDE 500, pumpa AMBRA 75	2	50	1	50	2.296,00 €	2.289,00 €
1010688	1010689	Arco - 15 m3/h filter PANAMA SIDE 650, pumpa BRETON 750S	3	50	2	50	2.148,00 €	2.413,00 €
1010655	1010656	Arco - 13,5 m3/h filter RIVALTA SIDE 600, pumpa BRETON 750S	3	50	2	50	2.307,00 €	2.302,00 €
1010690	1010691	Arco- 15 m3/h filter MEDITERRANEO SIDE 650, pumpa BRETON 750S	3	50	2	50	2.307,00 €	2.302,00 €
1010663	1010664	Arco- 15 m3/h filter MEDITERRANEO SIDE 650, pumpa BRETON 750S	4	50	3	50	2.413,00 €	2.408,00 €
1010692	1010693	Arco- 15 m3/h filter MEDITERRANEOSIDE650, pumpa AMBRA100	3	50	2	50	2.633,00 €	2.628,00 €
1010661	1010662	Arco- 15 m3/h filter MEDITERRANEOSIDE650, pumpa AMBRA100	4	50	3	50	2.739,00 €	2.734,00 €
1010659	1010660	Arco - 15 m3/h sa filter RIVALTA SIDE 650, pumpa BRETON 750S	4	50	3	50	2.458,00 €	2.452,00 €
1010657	1010658	Arco - 15 m3/h sa filter RIVALTA SIDE 650, pumpa AMBRA 100	4	50	3	50	2.784,00 €	2.778,00 €

Šifra monofaze	Šifra trifaze	Verzija prikači utičnicu kompletna sa razvodnom kutijom *i elektr. uredjajem "Plug and play" Version with electrical panel*	Asp.		Mand.		Cena monofaze	Cena trifaze
			N°	ø	N°	ø		
1010822	-	Arco - 6 m3/h sa filt. PANAMA TOP 400, pumpa BRETON 370S, R.kutija.	2	50	1	50	2.187,00 €	-
1010802	1010803	Arco - 9 m3/h sa filterom PANAMA SIDE 500, pumpa BRETON 550S, Razvodna kutija	2	50	1	50	2.226,00 €	2.282,00 €
1010667	1010668	Arco - 9 m3/h sa filterom MEDITERRANEO SIDE 500, pumpa AMBRA 75 Razvodna kutija	2	50	1	50	2.670,00 €	2.725,00 €
1010665	1010666	Arco - 9 m3/h sa filterom RIVALTA SIDE 500, pumpa BRETON 550S - R.KUT.	2	50	1	50	2.389,00 €	2.445,00 €
1010804	1010805	Arco - 9 m3/h sa filterom RIVALTA SIDE 500, pumpa AMBRA 75 - r.kutija.	2	50	1	50	2.722,00 €	2.777,00 €
1010806	1010807	Arco - 15 m3/h sa filterom PANAMA SIDE 650, pumpa BRETON 750S - Razv.kutija	3	50	2	50	2.575,00 €	2.631,00 €
1010669	1010670	Arco - 13,5 m3/h sa filterom RIVALTA SIDE 600, pumpa BRETON 750S - Razvodna kutija.	3	50	2	50	2.734,00 €	2.790,00 €
1010808	1010809	Arco - 15 m3/h sa filterom MEDITERRANEO SIDE 650, pumpa BRETON 750S - r.kut.	3	50	2	50	2.734,00 €	2.790,00 €
1010677	1010678	Arco - 15 m3/h sa filterom MEDITERRANEO SIDE 650, pumpa BRETON 750S - r.kutija.	4	50	3	50	2.879,00 €	2.935,00 €
7751010810	1010811	Arco - 15 m3/h sa filterom MEDITERRANEO SIDE 650, pumpa AMBRA 100 - r.kutija.	3	50	2	50	3.060,00 €	3.116,00 €
1010675	1010676	Arco - 15 m3/h sa filterom MEDITERRANEO SIDE 650, pumpa AMBRA 100 - razv.kutija	4	50	3	50	3.166,00 €	3.222,00 €
1010673	1010674	Arco - 15 m3/h sa filterom RIVALTA SIDE 650, pumpa BRETON 750S - razvodna kutija	4	50	3	50	2.884,00 €	2.940,00 €
1010671	1010672	Arco - 15 m3/h sa filterom RIVALTA SIDE 650, pumpa AMBRA 100 - r.kut.	4	50	3	50	3.210,00 €	3.267,00 €

*Il quadro elettrico non è previsto di salvavita / *The electrical panel is not provided of lifesaving

SEDICI

NOVI DESIGN
NEW DESIGN



Kompaktni prostor gde je smeštena pumpa i filter do 16 mc/h. Isporučen u kompletu sa aparaturom i u verziji priključi utičnicu, sa električnom tablom, povezanom pumpom, 2m spoljnog kabla sa utičnicom spreman za upotrebu. Na zahtev može se opremiti i izmenjivačem ili elektrolizom soli. Težina SEDICI kg 36.

Isporuka mašinskog prostora ne obuhvata pesak filtera.

Compact technical bunkers that supports a pump and a filter up to 16 m³/h. Delivered, in the "connected-plug" version, complete with electric panel, connected pump and a 2-m outer cable with plug. If requested, it may also be equipped with heat exchanger or salt electrolysis. Weight: 36 kg. The technical bunkers provision does not include the sand of the filter.



Šifra/ Code	Opis/Descrizione	Cena/ Price
1010260	Sedici prazan sa poklopcem / Sedici empty with lid	1.268,00 €
1010261	Poklopac za Sedici - zamena / Lid for Sedici - replacement	492,40 €

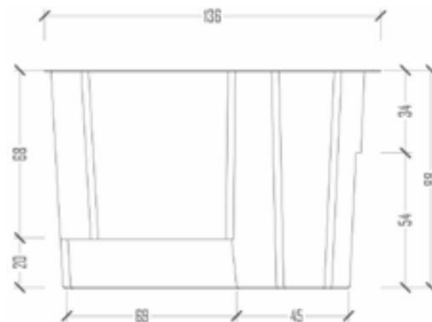
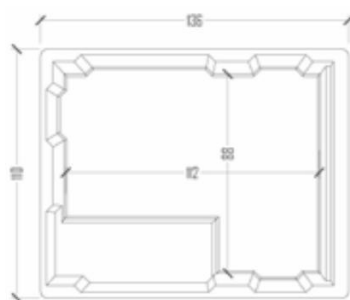

Šifra mono-faza	Šifra trofazni	Opis	Usis		protok		Cena monofaza	Cena trofazni
			N°	ø	N°	ø		
1010523	1010521	Sedici - 9 m ³ /h sa filterom PANAMA SIDE 500, pumpa BRETON 550S	3	50	2	50	2.653,00 €	2.648,00 €
1010212	1010213	Sedici - 15 m ³ /h sa filterom PANAMA SIDE 650, pumpa BRETON 750S	3	50	2	50	2.729,00 €	2.724,00 €
1010214	1010215	Sedici - 15 m ³ /h sa filterom RIVALTA SIDE 650, pumpa AMBRA 100	4	50	3	50	3.365,00 €	3.360,00 €
1010404	1010405	Sedici - 15 m ³ /h sa filterom RIVALTA SIDE 650, pumpa BRETON 750S	4	50	3	50	3.039,00 €	3.034,00 €
1010406	1010407	Sedici - 15 m ³ /h sa filterom MEDITERRANEO SIDE 650, pumpa AMBRA 100	4	50	3	50	3.321,00 €	3.315,00 €
1010408	1010409	Sedici - 15 m ³ /h sa filterom MEDITERRANEO SIDE 650, pumpa BRETON 750S	4	50	3	50	2.995,00 €	2.989,00 €

Šifra mono-faza	Šifra trifase	Verzija priključi utičnicu kompletan sa tablom i električnim uređajem* "Plug and play" Version with electrical panel*	Usis		protok		Cena monofaza	Cena trofazna
			N°	ø	N°	ø		
1010522	1010520	Sedici m ³ /h 9 sa filterom PANAMA SIDE 500, pumpa BRETON 550S, t. elekt.	3	50	2	50	3.101,00 €	3.136,00 €
1010264	1010265	Sedici - 15 m ³ /h sa filterom PANAMA SIDE 650, pumpa BRETON 750S, t. elekt.	3	50	2	50	3.180,00 €	3.212,00 €
1010266	1010267	Sedici - 15 m ³ /h sa filterom RIVALTA SIDE 650, pumpa AMBRA 100, t. elekt.	4	50	3	50	3.796,00 €	3.848,00 €
1010410	1010411	Sedici - 15 m ³ /h sa filterom RIVALTA SIDE 650, pumpa BRETON 750S, t. elekt.	4	50	3	50	3.494,00 €	3.522,00 €
1010412	1010413	Sedici - 15 m ³ /h sa filterom MEDITERRANEO SIDE 650, pumpa AMBRA 100, t. elekt.	4	50	3	50	3.752,00 €	3.804,00 €
1010414	1010415	Sedici - 15 m ³ /h sa filterom MEDITERRANEO SIDE 650, pumpa BRETON 750S, t. elekt.	4	50	3	50	3.450,00 €	3.477,00 €

*Električna tabla ne poseduje sigurnosni prekidač "spasi život" / *The electrical panel is not provided of lifesaving



Za verziju sa poklopcem stil pločice Castellane ili Rosalind predvideti uvećanje cene od € 60,00
For the version with cover-style tile Castellane or Rosalind consider a price increase of € 60.00



Kompaktna prostorija sa ugrađenom pumpom i filterom do 16 mc/h. Isporučen u kompletu aparatura i, u verziji prikači utičnicu, za razvodnom kutijom, povezanom pumpom, 2 m spoljnog kabela sa utičnicom za promptnu upotrebu. Po narudžbi može biti opremljen sa pretvaračem ili elektrolizom soli.

Isporuka mašinske prostorije ne podrazumeva pesak filtera.

Compact technical bunkers that supports a pump and a filter up to 16 m³/h. Delivered, in the "connected-plug" version, complete with electric panel, connected pump and a 2-m outer cable with plug. If requested, it may also be equipped with heat exchanger or salt electrolysis. The technical bunkers provision does not include the sand of the filter.

Šifra/ Code	Opis/Descrizione	Cena/Price
1010360	Kiwi prazan sas poklopcem / Kiwi empty with lid	1.173,00 €
1010361	Poklopac za Kiwi - zamena / Lid for Kiwi - replacement	455,00 €

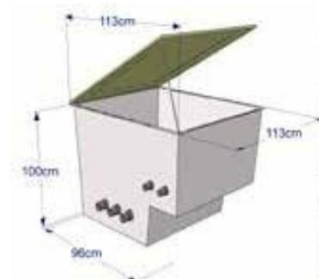
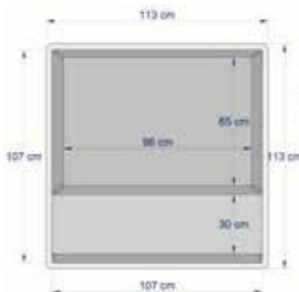

Codice monofase	Šifra trifase	Opis	Asp.		Mand.		Cena monofase	Cena trifase
			N°	ø	N°	ø		
1010362	-	Kiwi - 6 m ³ /h sa filterom PANAMASIDE 450, pumpa BRETON 550S	2	50	1	50	2.237,00 €	-
1010364	1010365	Kiwi - 9 m ³ /h sa filterom PANAMA SIDE 500, pumpa BRETON 550S	3	50	2	50	2.553,00 €	2.530,00 €
1010366	1010367	Kiwi - 14 m ³ /h con filterom PANAMA SIDE 650, pumpa BRETON 750S	3	50	2	50	2.629,00 €	2.484,00 €
1010765	1010766	Kiwi - 16 m ³ /h con filterom RIVALTA SIDE 650, pumpa AMBRA 100	4	50	3	50	3.265,00 €	3.259,00 €
1010569	1010568	Kiwi - 16 m ³ /h sa filterom RIVALTA SIDE 650, pumpa BRETON 750S	4	50	3	50	2.939,00 €	2.933,00 €
1010372	1010373	Kiwi-16m ³ /hsa filter MEDITERRANEOSIDE 650, pumpa AMBRA 100	4	50	3	50	3.220,00 €	2.969,00 €
1010571	1010572	Kiwi-16m ³ /hsa filter MEDITERRANEOSIDE 650, pumpa BRETON 750S	4	50	3	50	2.894,00 €	2.889,00 €

Šifra monofase	Šifra trifase	Verzija ukluči utičnicu kompletno sa razvodnom kutijom i elektr.pog.	Asp.		Mand.		Cena monofase	Cena trifase
			N°	ø	N°	ø		
1010573	-	Kiwi-6m ³ /hsa filter PANAMASIDE 450, pumpa BRETON 550S, q. Razv.kutija.	2	50	1	50	2.626,00 €	-
1010574	1010575	Kiwi - 9 m ³ /h sa filter PANAMASIDE 500, pumpa BRETON 550S, Razv.kutija	3	50	2	50	2.829,00 €	3.036,00 €
1010576	1010577	Kiwi - 14 m ³ /h sa filter PANAMASIDE 650, pumpa BRETON 750S, q. Razvodna kutija.	3	50	2	50	2.916,00 €	3.112,00 €
1010578	1010579	Kiwi-16m ³ /hsa filter RIVALTA SIDE 650, pumpa AMBRA 100, q.elett.	4	50	3	50	3.691,00 €	3.748,00 €
1010580	1010581	Kiwi-16m ³ /hsa filter RIVALTA SIDE 650, pumpa BRETON 750S, q. Razvodna kutija.	4	50	3	50	3.365,00 €	3.421,00 €
1010582	1010583	Kiwi-16m ³ /hsa filter MEDITERRANE OSIDE 650, pumpa AMBRA 100, Razvodna kutija.	4	50	3	50	3.659,00 €	3.703,00 €
1010584	1010585	Kiwi-16m ³ /hsa filter MEDITERRANEOSIDE 650, pumpa BRETON 750S, q. elett.	4	50	3	50	3.326,00 €	3.377,00 €

*Razvodna kutija ne podrazumeva sigurnosni prekidač zaštitu života / *The electrical panel is not provided of lifesaving

GARDEN

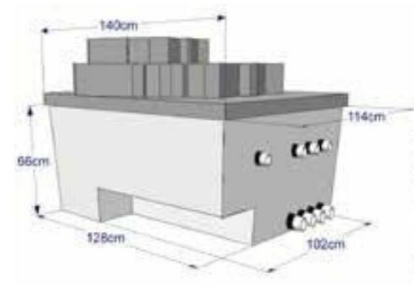
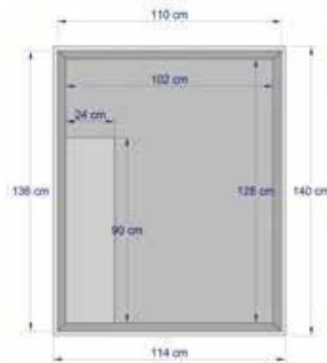

Kompaktna prostorija za smeštaj pumpe i filtera do 16 m³/h. Isporučena kompletna sa aparaturama i, u verziji "uključiti utičnicu", sa razvodnom kutijom, povezanom pumpom, 2m spoljnog kabla sa utičnicom za promptnu upotrebu. Elegantna i praktična ugrađuje se u baštama kao stena koja skladno izranja iz zemlje.

Isporuka mašinske prostorije ne sadrži pesak filtera.

Compact housing that has pump and filter up to 16 m³/h. Delivered complete with equipment and, in the version "attacks the plug", with the electric panel, pump connected, 2 m external cable with plug ready for use. Elegant and practical, it fits into the gardens like a rock that emerges harmoniously from the ground.

The technical bunkers provision does not include the sand of the filter.

Šifra/Code	Opis/Descrizione	Cena / Price
1010823	Garden prazan sa poklopcem / Garden empty with lid	1.624,00 €
1010824	Poklopac za Garden - zamena/Lid for Garden - re- placement	910,00 €

Šifra monofaze	Šifra trifase	Opis	Asp.		Mand.		Cena monofaze	Cena trifase
			N°	ø	N°	ø		
1010825	1010826	Garden - 9 m ³ /h sa filter PANAMASIDE500, pumpa BRETON550S	3	50	2	50	2.914,00 €	2.908,00 €
1010827	1010828	Garden - 9 m ³ /h filter RIVALTA SIDE 500, pumpa AMBRA 75	3	50	2	50	3.403,00 €	3.397,00 €
1010829	1010830	Garden - 15 m ³ /h filter PANAMASIDE650, pumpa BRETON750S	3	50	2	50	3.103,00 €	3.098,00 €
1010831	1010832	Garden - 13,5 m ³ /h filter RIVALTA SIDE600, pumpa AMBRA75	3	50	2	50	3.579,00 €	3.572,00 €
1010833	1010834	Garden - 15 m ³ /h filter RIVALTA SIDE650, pumpa AMBRA100	4	50	3	50	3.742,00 €	3.737,00 €
1010835	1010836	Garden - 15 m ³ /h filter RIVALTA SIDE650, pumpa BRETON750S	4	50	3	50	3.416,00 €	3.411,00 €
1010837	1010838	Garden 15 m ³ /h filter MEDITERRANEO SIDE 650, pumpa AMBRA	4	50	3	50	3.697,00 €	3.692,00 €
1010839	1010840	Garden - 15 m ³ /h filter MEDITERRANEO SIDE650, pumpa BRETON 750S	4	50	3	50	3.372,00 €	3.366,00 €

Šifra monofaze	Šifra trifase	Verzija uključiti utičnicu kompletna sa razv.kutijom i elektr.panelom* "Plug and play" Version with electrical panel*	Asp.		Mand.		Cena monofaze	Cena trifase
			N°	ø	N°	ø		
1010841	1010842	Garden - 9 m ³ /h filter PANAMA SIDE 500, pumpa BRETON 550S, q.elett.	3	50	2	50	3.341,00 €	3.397,00 €
1010843	1010844	Garden - 9 m ³ /h filter RIVALTA SIDE 500, pumpa AMBRA 75, q.elett.	3	50	2	50	3.830,00 €	3.885,00 €
1010845	1010846	Garden - 15 m ³ /h sa filterom PANAM SIDE 650, pumpa BRETON 750S, r.kutija.	3	50	2	50	3.530,00 €	3.586,00 €
1010847	1010848	Garden - 13,5 m ³ /h sa filterom RIVALTA SIDE 600, pumpa AMBRA 75, R.KUTIJA.	3	50	2	50	4.005,00 €	4.060,00 €
1010849	1010850	Garden - 15 m ³ /h sa filterom RIVALTA SIDE650, pumpa AMBRA100, R.KUTIJA.	4	50	3	50	4.169,00 €	4.225,00 €
1010851	1010852	Garden - 15 m ³ /h sa filterom RIVALTA SIDE650, pumpa BRETON750S, R.KUTIJA.	4	50	3	50	3.843,00 €	3.899,00 €
1010853	1010854	Garden - 15 m ³ /h sa filterom MEDITERRANEO SIDE 650, pumpa AM- AMBRA 100, razvod.kut	4	50	3	50	4.124,00 €	4.180,00 €
1010855	1010856	Garden - 15 m ³ /h filter MEDITER RANEO SIDE 650, pumpa BRETON 750S, r.kutija	4	50	3	50	3.798,00 €	3.854,00 €

*Razvodna kutija ne podrazumeva sigurnosni prekidač zaštitu života/ *The electrical panel is not provided of lifesaving

ROC



Praktičan i elegantan prostor za podzemni smeštaj svih tehničkih aparata. Projektovan sa z a t v o r e n i m design, opremljena jednostavnim pneumatskim otvaranjem, elegantno se uklapa u velikim baštama, sadrži opremu poput mediteranske stene koja harmonično izlazi iz zemljišta. Potpuno opremljen.

Isporučeni mašinski prostor ne predviđa filter peska.

*Elegant and practical housing for all technical equipment. Designed with a stylish fastening and a handy pneumatic opening, it is ideal for wide gardens. It contains its equipment as a Mediterranean cliff that harmoniously rises from the ground. Complete of all accessories. **The technical bunkers provision does not include the sand of the filter.***

Šifra/ code	Opis/description	Cena/ price
1010270	Roc Prazan sa poklopcem / Roc empty with lid	1.959,00 €
1010269	Roc 32 MC – Mašinski prostor prazan sa poklopcem Roc 32 MC - technical housing empty with lid	2.065,00 €
1010271	Poklopac za Roc - zamena / Lid for Roc - replacement	1.087,00 €

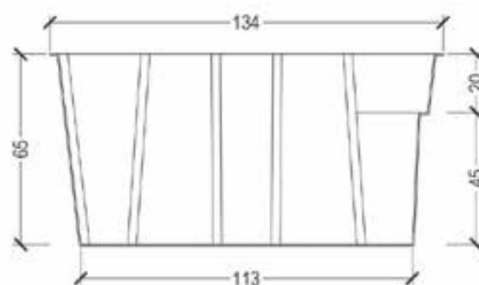
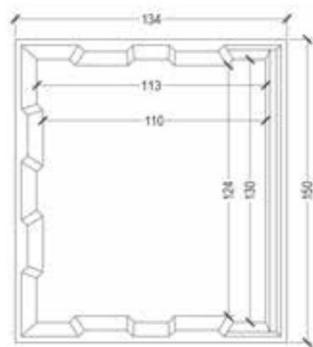

Šifra monofazne	Šifra trofazne	Opis	Usis		Protok		Cena monofazna	Cena trofazna
			N°	∅	N°	∅		
1010224	1010225	Roc - 13,5 m³/h sa filterom RIVALTA SIDE 600, pumpa AMBRA 100	3	50	2	50	4.016,00 €	4.011,00 €
1010442	1010443	Roc - 15 m³/h sa filterom MEDITERRANEO SIDE 650, pumpa BRETON 750S	4	50	3	50	3.799,00 €	3.794,00 €
1010446	1010447	Roc - 15 m³/h sa filterom MEDITERRANEO SIDE 650, pumpa AMBRA 100	4	50	3	50	4.125,00 €	4.120,00 €
1010230	1010231	Roc - 21 m³/h sa filterom RIVALTA SIDE 760, pumpa AMBRA 150	4+1	50+63	3	50	4.578,00 €	4.565,00 €
1010450	1010453	Roc - 21 m³/h sa filterom MEDITERRANEO S750, pumpa AMBRA 200	4+1	50+63	3	50	4.638,00 €	4.613,00 €
1010454	1010455	Roc - 21 m³/h sa filterom MEDITERRANEO S750, pumpa VIENNA 200	4+1	50+63	3	50	4.284,00 €	4.279,00 €
1010458	1010459	Roc - 30 m³/h sa filterom MEDITERRANEO S900, pumpa VIENNA 300	4+1	50+63	3	50	4.680,00 €	4.674,00 €

Šifra monofaze	Šifra trofazna	Verzija priključi utičnicu kompletna sa tablom i uređajem električnim* "Plug and play" Version with electrical panel*	Usis		Protok		Cena monofaza	Cena trofazna
			N°	∅	N°	∅		
1010272	1010273	Roc - 13,5 m³/h sa RIVALTA SIDE 600, pumpa AMBRA 100, t. elekt.	3	50	2	50	4.443,00 €	4.491,00 €
1010444	1010445	Roc - 15 m³/h sa MEDITERRANEO SIDE 650, BRETON 750S, t. elekt.	4	50	3	50	4.226,00 €	4.282,00 €
1010448	1010449	Roc - 15 m³/h sa filterom MEDITERRANEO SIDE 650, AMBRA 100, t. elekt.	4	50	3	50	4.552,00 €	4.608,00 €
1010276	1010277	Roc - 21 m³/h sa filterom RIVALTA SIDE 760, AMBRA 150, t. elekt.	4+1	50+63	3	50	5.005,00 €	5.053,00 €
1010452	1010463	Roc - 21 m³/h sa filterom MEDITERRANEO S750, AMBRA 200, q. elefft.	4+1	50+63	3	50	5.193,00 €	5.101,00 €
1010456	1010457	Roc - 21 m³/h sa filterom MEDITERRANEO S750, VIENNA 200, t. elekt.	4+1	50+63	3	50	4.839,00 €	4.765,00 €
1010460	1010461	Roc - 30 m³/h sa filterom MEDITERRANEO S900, pumpa VIENNA 300, t. elekt.	4+1	50+63	3	50	5.306,00 €	5.163,00 €

*Električna tabla ne poseduje sigurnosni prekidač "spasi život" / *The electrical panel is not provided of lifesaving

COMODO

NOVI DESIGN

NEW DESIGN



Mašinski prostor za smeštaj pumpe i jednog filtera do 900 mm. Possono essere installate Svi aparati za spremu opreme: izmenjivač toplote, elektroliza soli, lampa zraci U.V. "Comodo" je takođe kompletan u verziji "prikluči utičnicu" sa električnom tablom, pumpom i 2 m spoljnog kabla sa utičnicom. Težina: 67 kg.

Isporuka mašinskog prostora ne predviđa pesak filtera.

Technical bunkers able to support a pump and a filter up to 900 mm. It is possible to install all the plant equipment: heat exchanger, salt electrolysis, U.V. lamp. "Comodo" is also equipped with electric panel, pump and 2-m outer cable with plug. Weight 67 kg. **The technical bunkers provision does not include the sand of the filter.**

Šifra/ code	Opis	Cena/ price
1010030	Comodo prazan sa poklopcem h=102 cm/Comodo empty with lid h=102 cm	1.684,00 €
1010032	Comodo ALTO prazan sa poklopcem h=135 cm Big Comodo empty with lid h=135 cm	1.925,00 €
1010031	Poklopac za Comodo - zamena vv Lid for Comodo - replacement	614,00 €

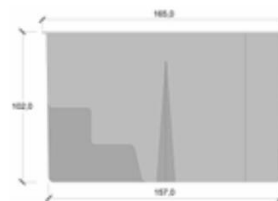
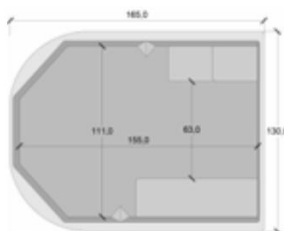

Šifra monofaza	Šifra trifaze	Opis	Usis		Protok		Cena monofaze	Cena trofazni
			N°	ø	N°	ø		
1010035	1010036	Comodo - 9 m³/h sa filterom MEDITERRANEO 500, pumpa BRETON 550	3	50	2	50	3.169,00 €	3.168,00 €
1010062	1010063	Comodo - 13,5 m³/h sa filterom RIVALTA 600, pumpa AMBRA 100	3	50	2	50	3.728,00 €	3.723,00 €
1010043	1010044	Comodo - 15 m³/h sa filterom RIVALTA 650, pumpa AMBRA 100	4	50	3	50	3.879,00 €	3.873,00 €
1010416	1010417	Comodo - 15 m³/h sa filterom PANAMA 650, pumpa BRETON 750S	4	50	3	50	3.349,00 €	3.344,00 €
1010064	1010065	Comodo - 21 m³/h sa filterom RIVALTA 760, pumpa AMBRA 150	4+1	50+63	3	50	4.287,00 €	4.276,00 €
1010047	1010048	Comodo ALTO - 30 m³/h sa filterom RIVALTA 900, pumpa AMBRA 300	4+1	50+63	3	50	4.797,00 €	4.784,00 €
1010428	1010429	Comodo ALTO - 30 m³/h sa filterom MEDITERRANEO 900, pumpa AMBRA 300	4+1	50+63	3	50	4.825,00 €	4.812,00 €
1010420	1010421	Comodo - 15 m³/h sa filterom MEDITERRANEO SIDE 650, pumpa AMBRA 100	4	50	3	50	3.834,00 €	3.829,00 €
1010424	1010425	Comodo - 15 m³/h sa filterom MEDITERRANEO SIDE 650, pumpa BRETON 750S	4	50	3	50	3.508,00 €	3.503,00 €
1010432	1010433	Comodo - 21 m³/h sa filterom MEDITERRANEO SIDE 750, pumpa AMBRA 200	4+1	50+63	3	50	4.347,00 €	4.324,00 €
1010436	1010437	Comodo - 21 m³/h sa filterom MEDITERRANEO SIDE 750, pumpa VIENNA 200	4+1	50+63	3	50	3.993,00 €	3.988,00 €

Šifra monofaza	Šifra trofazna	Verzija priključi utičnicu kompletna sa tablom i električnim uređajem * "Plug and play" Version with electrical panel*	Usis		protok		cena monofaze	cena trofazne
			N°	ø	N°	ø		
1010280	1010281	Comodo - 9 m³/h sa filterom MEDITERRANEO 500, pumpa BRETON 550, q. elett.	3	50	2	50	3.596,00 €	3.656,00 €
1010286	1010287	Comodo - 13,5 m³/h sa filterom RIVALTA 600, pumpa AMBRA 100, q. elett.	3	50	2	50	4.155,00 €	4.211,00 €
1010288	1010289	Comodo - 15 m³/h sa filterom RIVALTA 650, pumpa AMBRA 100, q. elett.	4	50	3	50	4.305,00 €	4.362,00 €
1010418	1010419	Comodo - 15 m³/h sa filterom PANAMA 650, pumpa BRETON 750S, q. elett.	4	50	3	50	3.776,00 €	3.832,00 €
1010290	1010291	Comodo - 21 m³/h sa filterom RIVALTA 760, pumpa AMBRA 150, q. elett.	4+1	50+63	3	50	4.714,00 €	4.764,00 €
1010294	1010295	Comodo ALTO - 30 m³/h sa filterom RIVALTA 900, pumpa AMBRA 300, q. elett.	4+1	50+63	3	50	5.423,00 €	5.272,00 €
1010430	1010431	Comodo ALTO - 30 m³/h sa filterom MEDITERRANEO 900, AMBRA 300, q. elett.	4+1	50+63	3	50	5.252,00 €	5.300,00 €
1010422	1010423	Comodo - 15 m³/h sa MEDITERRANEO SIDE 650, pumpa AMBRA 100, q. elett.	4	50	3	50	4.261,00 €	4.317,00 €
1010426	1010427	Comodo - 15 m³/h sa MEDITERRANEO SIDE 650, pumpa BRETON 750S, q. elett.	4	50	3	50	3.935,00 €	3.991,00 €
1010434	1010435	Comodo - 21 m³/h sa MEDITERRANEO SIDE 750, AMBRA 200, t. elekt.	4+1	50+63	3	50	4.902,00 €	4.812,00 €
1010438	1010439	Comodo - 21 m³/h sa filterom MEDITERRANEO SIDE 750, pumpa VIENNA 200, t. elekt.	4+1	50+63	3	50	4.548,00 €	4.476,00 €

*Električna table ne poseduje sigurnosni prekidač "spasi život" / *The electrical panel is not provided of lifesaving

Sa poklopcem stile pločica Castellane ili Rosalind predvideti uvećanje cene od € 80,00
For the version with cover-style tile Castellane or Rosalind consider a price increase of € 80,00

BELBO



Inovativna i prilagodljiva mašinska prostorija koja može da primi filter i pumpu do nosivost od 30 mc/h ili se može opremiti za hidromasažne uređaje u kompletu sa pumpama, kompreorima i komadnim tablama, itd. Idealna kao kompenzaciona kada, za mali prelivni bazen ili za profesionalnu SPA . Prostorija poseduje poklopac sa sigurnosnom bravom. **Isporuka mašinske prostorije ne sadrži pesak filtera.**

*This technical bunkers is innovative and versatile, it can accommodate complete filtration system up to 30 mc/h or plant for hydromassage, for pump blower, electric panels, etc. Also great for compensation tank, for a small swimming pools or professional SPA. Cover with safetylock. **The technical bunkers provision does not include the sand of the filter.***

Šifra/code	Opis/description	Cena/price
1011000	Belbo prazan sa poklopcem / Belbo empty with lid	1.651,00 €
1011001	Poklopac za Belbo - zamena / Lid for Belbo -replacement	637,00 €

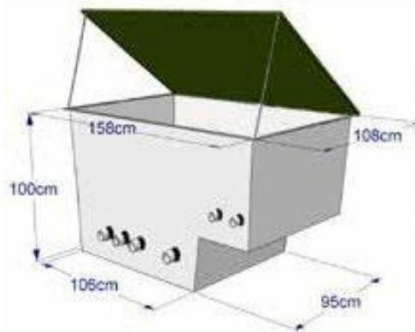
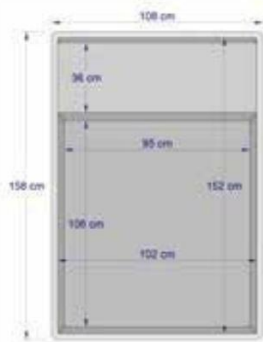

Na raspolaganju takođe poklopac verzije pločice Castellane*
Available with Castellane tiles cover style*

Prostorija za slaganje

Šifra monofaze	Šifra trifaze	Opis	Asp.		Mand.		Cena monofaze	Cena trifaze
			N°	ø	N°	ø		
1011002	1011003	Belbo-9m3/h filter MEDITERRANEO500,pumpaBRETON550	3	50	2	50	2.898,00 €	2.892,00 €
1011004	1011005	Belbo - 15 m3/h filter RIVALTA 650, pumpa AMBRA 100	4	50	3	50	3.771,00 €	3.776,00 €
1011012	1011013	Belbo-16m3/h filter MEDITERRANEO650,pumpaAMBRA100	4	50	3	50	3.726,00 €	3.721,00 €
1011006	1011007	Belbo - 21 m3/h filter RIVALTA 760, pumpa AMBRA 150	4+1	50+63	3	50	4.180,00 €	4.168,00 €
1011008	1011009	Belbo-21m3/h filter MEDITERRANEO SIDE750,pumpaAMBRA200	4+1	50+63	3	50	4.239,00 €	4.216,00 €
1011010	1011011	Belbo-21m3/h filter MEDITERRANEO SIDE750,pumpaVIENNA200	4+1	50+63	3	50	3.886,00 €	3.880,00 €

Šifra monofaze	Šifra trifaze	Verzija uključujući utičnicu kompletno sa razvodnom i elektr.kutijom "Plug and play" Version with electrical panel*	Asp.		Mand.		Cena monofaze	Cena trifaze
			N°	ø	N°	ø		
1011030	1011031	Belbo-9m3/h filter MEDITERRANEO500,pumpaBRETON550, razvodna kutija	3	50	2	50	3.399,00 €	3.454,00 €
1011032	1011033	Belbo-15m3/h filter RIVALTA650,pumpaAMBRA100,r.kutija	4	50	3	50	4.198,00 €	4.254,00 €
1011014	1011015	Belbo - 16 m3/h filter MEDITERRANEO 650, pumpa AMBRA 100, r.kutija	4	50	3	50	4.153,00 €	4.209,00 €
1011034	1011035	Belbo-21m3/hfilterRIVALTA760,pumpaAMBRA150,r.kutija.	4+1	50+63	3	50	4.606,00 €	4.794,00 €
1011036	1011037	Belbo - 21 m3/h sa MEDITERRANEO SIDE 750, AMBRA 200, razvodna kutija.	4+1	50+63	3	50	4.794,00 €	4.704,00 €
1011038	1011039	Belbo - 21 m3/h filter MEDITERRANEO SIDE 750, pumpa VIENNA 200,r.kutija.	4+1	50+63	3	50	4.441,00 €	4.368,00 €

*razvodna kutija ne predviđa zaštitu života / *The electrical panel is not provided of lifesaving

Za verziju sa poklopcem stil pločica Castellane podrazumeva se uvećana cena za € 80,00
For the version with cover-style tile Castellane consider a price increase of € 80,00

HELLIO



Ukopana prostorija velikog smeštajnog kapaciteta, dva filtera i dve pumpe, jedan panel Hloro-ph, filtracija i hidromasaža, protivklizni poklopac sa svom serijskom opremom. Težina kg.122. **Isporuka mašinske prostorije ne sadrži pesak filtera.**

*Technical bunkers set into the ground with large capacity, two filters and two pumps, PH Adjustmen, filtering and hydromassage, cover slip and with all standard accessories. Weight kg.122. **The technical bunkers provision does not include the sand of the filter.***

Šifra/ code	Opis/description	Cena/ price
1010080	Hellio prazan sa poklopcem / Hellio empty with lid	2.880,00 €
1010081	Poklopac za Hellio - zamena/ Lid for Hellio - replacement	1.169,00 €

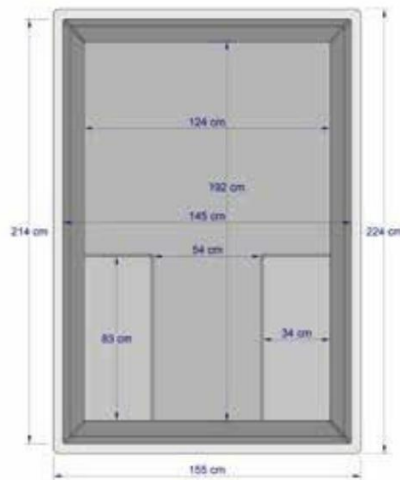
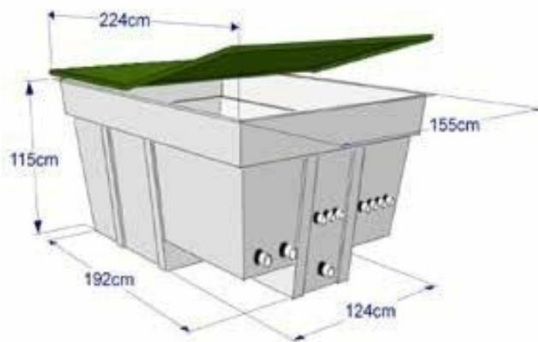

Šifra monofaze	Šifra trifaze	Opis	Asp.		Mand.		Cena monofaze	Cena trifaze
			N°	ø	N°	ø		
1010120	1010121	Hellio-15m3/h filter MEDITERRANEO650,pumpaAMBRA100	4	50	3	50	5.395,00 €	5.390,00 €
1010124	1010125	Hellio - 21 m3/h filter RIVALTA 760, pumpa AMBRA 150	4	50	3	50	5.848,00 €	5.837,00 €
1010126	1010127	Hellio - 30 m3/h filter RIVALTA 900, pumpa AMBRA 300	4+1	50+63	3	50	6.102,00 €	6.089,00 €
1010530	1010531	Hellio- 30 m3/h filter MEDITERRANEO 900, pumpa AMBRA 300	4+1	50+63	3	50	6.069,00 €	6.055,00 €
1010151	1010152	Hellio-27m3/h dva filteraRIVALTA600,dvepumpeAMBRA100	5	50	4	50	6.639,00 €	6.628,00 €
1010464	1010465	Hellio - 30 m3/h dva filteraMEDITERRANEO650,dve pumpe AMBRA 100	5	50	4	50	6.639,00 €	6.628,00 €
1010468	1010469	Hellio - 30 m3/hconduetiltriMEDITERRANEO650,dve pumpe BRETON 750S	5	50	4	50	5.987,00 €	5.976,00 €

Šifra monofaze	Šifra trifaze	Verzija uključujući utičnicu za razvodnom i električnom tablom* "Plug and play" Version with electrical panel*	Asp.		Mand.		Cena monofaze	Cena trifaze
			N°	ø	N°	ø		
1010300	1010301	Hellio-15m3/h FILTER MEDITERRANEO 650, pumpa AMBRA 100, Razvodna kutija.	4	50	3	50	5.826,00 €	5.878,00 €
1010306	1010307	Hellio - 21 m3/h FILTER RIVALTA 760,pumpaAMBRA150, R.kutija.	4	50	3	50	6.294,00 €	6.325,00 €
1010308	1010309	Hellio-30m3/hfilter RIVALTA 900,pumpaAMBRA300, R.kutija.	4+1	50+63	3	50	6.714,00 €	6.544,00 €
1010534	1010535	Hellio-30m3/h filter MEDITERR ANEO 900, pumpa AMBRA 300, Razvodna kutija.	4+1	50+63	3	50	6.747,00 €	6.577,00 €
1010312	1010313	Hellio-27m3/h 2 filtera RIVALTA 600, due pumpe AMBRA 100, Razvodna kutija	5	50	4	50	7.344,00 €	7.377,00 €
1010466	1010467	Hellio-30m3/h 2filtera MEDITERRANEO650,dve pumpe AMBRA 100, razvodna kutija.	5	50	4	50	7.346,00 €	7.377,00 €
1010470	1010471	Hellio-30m3/h dva filteraMEDITERRANEO650, dve pumpe BRETON 750S, razvodna kutija.	5	50	4	50	6.742,00 €	6.725,00 €

*Il quadro elettrico non è previsto di salvavita / *The electrical panel is not provided of lifesaving

GLOBO



Svestran i kompletan prostor , idealan za velike bazene. Pored toga što sadrži dva filtera, može sadržati kontrolne aparature i regulaciju vode. Poklopac sa sigurnosnom bravom. Idelan je takođe kao kompenzaciono korito za standardne bazene. Težina: 144kg.

Isporuka mašinske prostorije ne obuhvata pesak filtera.

Versatile and complete technical bunkers, suitable for wide swimming pools. Besides housing two filters, it can hold control equipment and water adjustment. Cover with safety lock. It can also be used as a compensation tank for standard swimming pools. Weight 144 kg.

The technical bunkers provision does not include the sand of the filter.

Šifra/ code	Opis/description	Cena price
1010100	Globo prazan sa poklopcem / Globo empty with lid	3.184,00 €
1010101	Poklopac za Globo – zamena 234x193 cm Lid for Globo - replacement	1.084,00 €

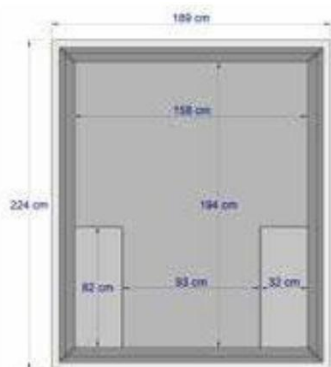

Šifra monofaze	Šifra trifaze	Opis	Asp.		Mand.		Cena monofaze	Cena trifaze
			N°	∅	N°	∅		
1010185	1010186	Globo - 15 m3/h sa filterom RIVALTA 650, pumpa AMBRA 100	3	50	2	50	5.359,00 €	5.354,00 €
1010191	1010192	Globo - 30 m3/h sa filterom RIVALTA 900, pumpa AMBRA 300	5	50	4	50	6.432,00 €	6.419,00 €
1010195	1010196	Globo - 27 m3/h sa dve filtera RIVALTA 600, dve pumpe AMBRA 100	5	50	4	50	6.961,00 €	6.950,00 €
1010197	1010198	Globo - 30 m3/h sa dva filtera RIVALTA 650, dve pumpe AMBRA 100	5	50	4	50	7.049,00 €	7.039,00 €
1010199	1010200	Globo - 42 m3/h sa dva filtera RIVALTA 760, dve pumpe AMBRA 150	5	50	4	50	7.996,00 €	7.974,00 €
1010474	1010475	Globo - 30 m3/h sa dva filtera MEDITERRANEOS650, dve pumpe BRETON 750S	5	50	4	50	6.309,00 €	6.298,00 €
1010478	1010479	Globo - 30 m3/h sa dva filtera MEDITERRANEOS650, dve pumpe AMBRA 100	5	50	4	50	6.961,00 €	6.950,00 €
1010482	1010483	Globo - 42 m3/h sa dva filtera MEDITERRANEOS750, dve pumpe AMBRA 150	5	50	4	50	8.063,00 €	8.041,00 €
1010486	1010487	Globo - 42 m3/h sa dva filtera MEDITERRANEOS750, dve pumpe AMBRA 150	5	50	4	50	8.063,00 €	8.041,00 €

Šifra monofaze	Šifra trifaze	Verzija uključujući utičnicu sa razvodnom i električnom tablom* "Plug and play" Version with electrical panel*	Asp.		Mand.		Cena monofaze	Cena trifaze
			N°	∅	N°	∅		
1010320	1010321	Globo - 15 m3/h filter RIVALTA650, pumpa AMBRA100, r.kutija.	3	50	2	50	5.786,00 €	5.842,00 €
1010326	1010327	Globo - 30 m3/h filter RIVALTA900, pumpa AMBRA300, r.kutija.	5	50	4	50	7.058,00 €	6.907,00 €
1010330	1010331	Globo - 27 m3/h dva filtera RIVALTA600, dve pumpe AMBRA100, r.kutija.	5	50	4	50	7.656,00 €	7.699,00 €
1010332	1010333	Globo - 30 m3/h dva filtera RIVALTA650, dve pumpe AMBRA100, r.kutija.	5	50	4	50	7.745,00 €	7.788,00 €
1010334	1010335	Globo - 42 m3/h dva filtera RIVALTA760, dve pumpe AMBRA150, r.kutija.	5	50	4	50	8.692,00 €	8.723,00 €
1010476	1010477	Globo - 30 m3/h dva filtera MEDITERRANEO S 650, dve pumpe BRETON 750S, r.kutija	5	50	4	50	7.004,00 €	7.047,00 €
1010480	1010481	Globo - 30 m3/h sa dva filtera MEDITERRANEOS650, dve pumpe AMBRA 100, r.kutija	5	50	4	50	7.656,00 €	7.699,00 €
1010484	1010485	Globo - 42 m3/h sa 2 MEDITERRANEO S 750, dve AMBRA 150, r.kutija.	5	50	4	50	8.759,00 €	8.790,00 €
1010488	1010489	Globo - 42 m3/h sa 2 MEDITERRANEO S 750, 2 AMBRA 150, r.kutija	5	50	4	50	8.901,00 €	8.915,00 €

*Razvodna kutija ne sadrži sigurnosni taster zaštitu života / *The electrical panel is not provided of lifesaving

MASTER



Mašinski prostor za bazene velikih dimenzija i za javne bazene. Ima velike dimenzije radi smeštaja 2 filtera i 2 pumpe sa predfilterom, prapratna oprema uređaja: izmenjivač, razvodna kutija itd. Poklopac sa sigurnosnom bravom i otvaranjem sa vazдушnim klipovima. Isporuka mašinske prostorije ne obuhvata pesak filtera.

Technical bunkers for public swimming pool. Large dimensions to accomodate 2 filters and 3 pumps with pre-filter, plant equipment, heat exchanger, electrical panel etc... Cover with safety lock and air piston cover opening. **The technical bunkers provision does not include the sand of the filter.**

Šifra/ code	Opis/description	Cena/ price
1010600	Master prazan sa poklopcem / Master empty with lid	3.820,00 €
1010601	Poklopac za master Master - zamena / Lid - replacement	1.265,00 €

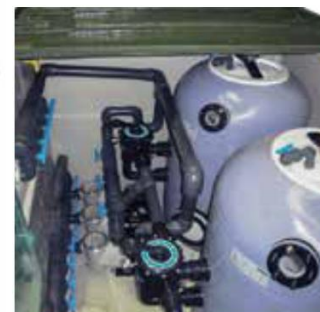
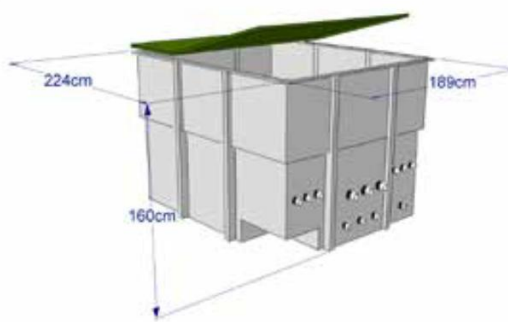
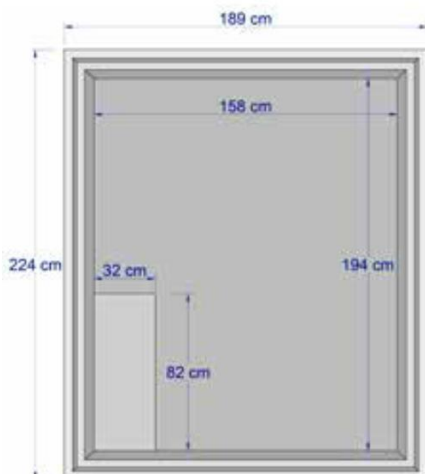

Šifra monofaze	Šifra trifaze	Opis	Usis		Protok		Cena monofazni	cena trifazni
			N°	∅	N°	∅		
1010767	1010768	Master - 11 m3/h con 1 BLU HBS 650, 2 AMBRA 75	5	50	4	50	8.714,00 €	8.701,00 €
1010769	1010770	Master - 15 m3/h con 1 BLU HBS 750, 2 AMBRA 100	5	50	4	50	9.076,00 €	9.066,00 €
1010610	1010611	Master - 21,5 m3/h con 2 BLU HBS 650, 3 BRETON 750S	5	50	4	50	9.164,00 €	9.149,00 €
1010540	1010541	Master - 30 m3/h con 2 BLU HBS 750, 2 AMBRA 150	3+2	50+63	4	50	9.623,00 €	9.601,00 €
1010606	1010607	Master - 34 m3/h con 2 POLARIS 800, 3 AMBRA 200	3+2	50+63	4	50	13.736,00 €	13.666,00 €
1010602	1010603	Master - 30 m3/h con 2 BLU HBS 750, 3 AMBRA 150	3+2	50+63	4	50	10.550,00 €	10.516,00 €
1010604	1010605	Master - 21,5 m3/h con 2 BLU HBS 650, 3 AMBRA 100	3+2	50+63	4	50	10.180,00 €	10.165,00 €

ATLANTIC



Mašinski prostor za javne bazene kategorije "A" i "B". Velikih dimenzija radi smeštaja 2 filtera sa spremnikom za pesak od 1 m e 3 pumpe sa predfilterom, aparati u sklopu uređaja, izmenjivač, razvodna kutija itd... Otvaranje poklopca sa vazдушnim klipovima i sigurnosno zatvaranje. Opremljen odgovarajućom opremom pruža mogućnost kompenzacionog rezervoara od 8 m³.

Isporuka mašinskog prostora ne obuhvata pesak filtera.

Technical bunkers for public swimming pools of "A" and "B" categories. Large dimensions to accommodate two filters with 1 m sand bed and three pumps with pre-filter, plant equipment, heat exchanger, electrical panel etc... Airtight cover opening and safety lock. Equipped with proper fittings, it can also be an 8 m³ compensation tank.

The technical bunkers provision does not include the sand of the filter.

Codice/code	Descrizione/description	Prezzo/price
1010500	Atlantic vuoto con coperchio / Atlantic empty with lid	5.422,00 €
1010513	Coperchio per Atlantic / Lid - replacement	1.594,00 €

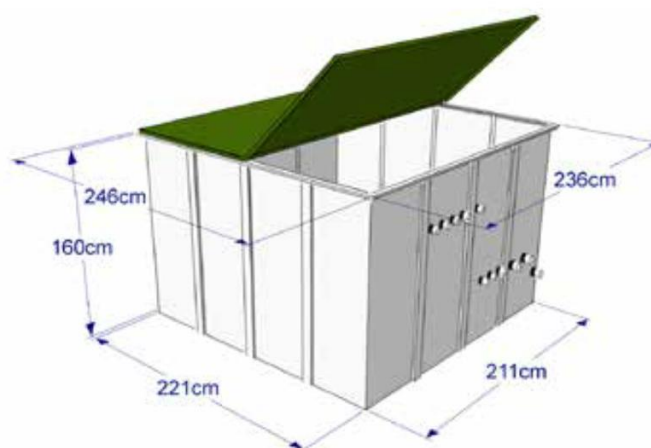
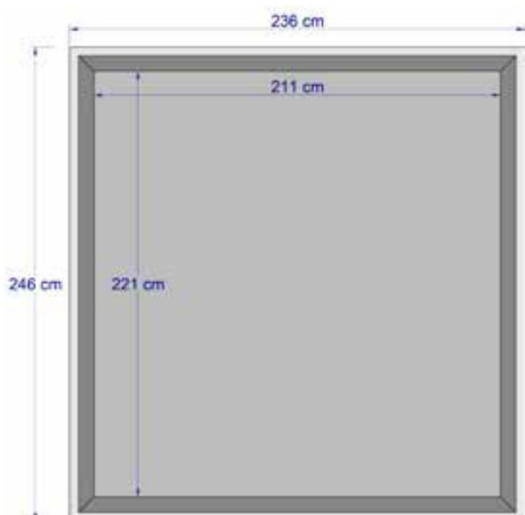

Codice monofase	Codice trifase	Descrizione	Asp.		Mand.		Prezzo monofase	Prezzo trifase
			N°	ø	N°	ø		
1010771	1010772	Atlantic - 21 m ³ /h con 1 BLU HBS 900, 2 AMBRA 200	5	50	6	50	11.310,00 €	11.264,00 €
1010773	1010774	Atlantic - 26 m ³ /h con 1 BLU HBS 1000, 2 AMBRA 300	5	50	6	50	12.531,00 €	12.504,00 €
1010516	1010517	Atlantic - 30 m ³ /h con 2 BLU HBS 750, 3 AMBRA 100	3+2	50+63	4	50	11.869,00 €	11.854,00 €
1010515	1010514	Atlantic - 42 m ³ /h con 2 BLU HBS 900, 3 AMBRA 150	5	50	6	50	14.673,00 €	14.640,00 €
1010501	1010502	Atlantic - 52 m ³ /h con 2 BLU HBS 1000, 3 AMBRA 300	5	50	6	50	16.978,00 €	16.938,00 €
1010509	1010510	Atlantic - 42 m ³ /h con 2 Tanaro 900, 3 AMBRA 200	5	50	6	50	18.400,00 €	18.331,00 €
1010511	1010512	Atlantic - 52 m ³ /h con 2 Tanaro 1000, 3 AMBRA 300	5	50	6	50	19.938,00 €	19.898,00 €

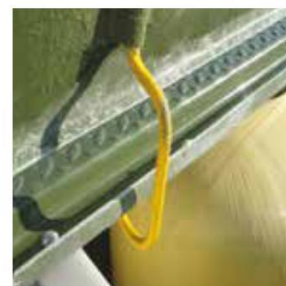

FILTER ZID MODEL IKARUS E APOLLO/ WALL FILTER IKARUS AND APOLLO MODEL



VERZIJA IKARUS / IKARUS VERSION



Sadrži filtracione aparature (pumpu i filter na pesak ili ketridž), skimer, dve/tri potisne mlaznice, usisnu mlaznicu, jedan reflektor. Ne trebaju mu drugi uređaji.
Isporuka mašinske prostorije ne sadrži pesak filtera.

Technical bunkers designed to accommodate filtering equipment (pump and sand or cartridge filter), one skimmer, two/three return fittings, one suction nozzle, one projector. Additional plants are not required. **The technical bunkers provision does not include the sand of the filter.**

VERZIJA APOLLO / APOLLO VERSION



Šifra/code	Opis/description	Cena/price
1010340	Ikarus prazan sa poklopcem / Ikarus empty with lid	1.726,00 €
1010341	Apollo prazan sa poklopcem / Apollo empty with lid	2.434,00 €

DIMENZIJE / DIMENSIONS

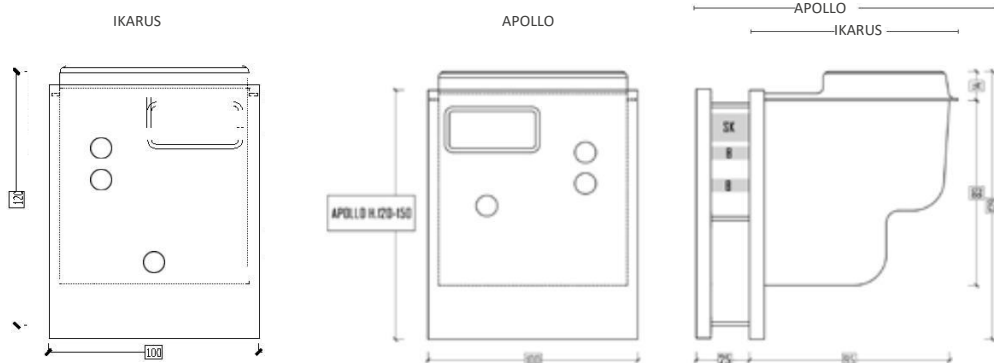

MAŠINSKE PROSTORIJE/

Šifra monofaze	Šifra trifaze	Raspoložive verzije	Cena monofaze	Cena trifaze
PEŠČANI FILTER				
1010339	1010342	Ikarus mc/h 9 sa PANAMA TOP 500, pumpa 0,75 cv	3.711,00 €	3.706,00 €
VERZIJA SKIMFILTRE				
1010345	1010346	Ikarus mc/h 10 sa SKIMFILTRE ELEGANCE 400, pumpa 1,00 cv	4.549,00 €	4.544,00 €
1010203	1010207	Apollo mc/h 16 sa SKIMFILTRE ELEGANCE 400 16 m3, pumpa AMBRA 1,00 cv, ravnim reflektorom 30 LED bianco 17.7 W/12V, skimmer a bocca svasata	4.938,00 €	4.933,00 €
KETRIDŽ FILTER				
1010202	1010206	Apollo mc/h 10 sa BRETON 550, filtro KFC, pumpa 0,75 cv, ravnim reflektorom 30 LED beli 17.7 W/12V, skimer širokog otvora	4.459,00 €	5.370,00 €
Verzija "uključi utičnicu" sa razvodnom kutijom i elektrouredajem* "Plug and play" Version with electrical panel*				
1010347	1010348	Ikarus mc/h 9 sa PANAMA TOP 500, pumpa 0,75 cv, razvodna kutija	4.138,00 €	4.194,00 €
1010351	1010201	Ikarus mc/h 10 con SKIMFILTRE ELEGANCE 400, pumpa 1,00 cv, razvodna kutija	4.976,00 €	5.032,00 €
1010204	1010208	Apollo mc/h 9 con BRETON 550, pumpa 0,75 cv, filter MEDITERRANEO TOP 500, ravnim reflektorom 30 LED beli 17.7 W/12V, skimer a širokog otvora**	5.315,00 €	5.370,00 €

*Razvodna table poseduje zaštitu života/ The electrical panel is not provided of lifesaving

**sa transformatorom cod. 1090395 12V ac - 100VA / with trasformer cod. 1090395 12V ac - 100VA

POSTOLJE BOX 65/75 BOX 65/75 BASE

Opremljeno postolje gde se može smestiti filter prečnika od 650 do 750 mm. Na raspolaganju verzije standard i u verziji sa elektrolizom i dozirnom pumpom pH.

Dimenzije postolja: 149 cm x 90 x h 149 cm.

Assembled base able to contain a filter with a diameter of 650 or 750 mm. Available in the standard version and in the version with electrolysis and pH dosing pump.

Dimensions of the base: 149 cm x 90 x h 149 cm.

Šifra monofaze	Šifra trifaze	Opis	Usis		Protok		Cena monofaze	Cena trifazna
			N°	∅	N°	∅		
BOX STANDARD								
1010590	1010592	BOX 50 con sa filter MEDITERRANEO SIDE 500, pompa AMBRA 50 BOX 50 with filter MEDITERRANEO SIDE 500, pump AMBRA 50	2	50	1	50	2.791,00 €	2.867,00 €
1010560	1010561	BOX 65 sa filterom MEDITERRANEO SIDE 650, pompa AMBRA 100 BOX 65 with filter MEDITERRANEO SIDE 650, pump AMBRA 100	4	50	3	50	3.140,00 €	3.168,00 €
1010562	1010563	BOX 75 sa filterom MEDITERRANEO SIDE 750, pompa AMBRA 150 BOX 75 with filter MEDITERRANEO SIDE 750, pump AMBRA 150	4	50	3	50	3.440,00 €	3.631,00 €
BOX SA ELEKTROLIZOM								
1010591	1010593	BOX 50 sa filterom MEDITERRANEO SIDE 500, pompa AMBRA 50, AUTOCHLOR RP-PH 15 BOX 50 with filter MEDITERRANEO SIDE 500, pump AMBRA 50, AUTOCHLOR RP-PH 15	2	50	1	50	4.224,00 €	4.300,00 €
1010564	1010565	BOX 65 sa filterom MEDITERRANEO SIDE 650, pompa AMBRA 100, AUTOCHLOR RP-PH 15 BOX 65 with filter MEDITERRANEO SIDE 650, pump AMBRA 100, AUTOCHLOR RP-PH 15	4	50	3	50	4.653,00 €	4.681,00 €
1010566	1010567	BOX 75 sa filterom MEDITERRANEO SIDE 750, pompa AMBRA 150, AUTOCHLOR RP-PH 20 BOX 75 with filter MEDITERRANEO SIDE 750, pump AMBRA 150, AUTOCHLOR RP-PH 20	4	50	3	50	5.430,00 €	5.453,00 €



**PRIKLJUČCI I FITING ZA MAŠINSKI PROSTOR
CONNECTIONS AND FITTINGS FOR TECHNICAL BUNKERS**

Šifra/ code	Opis/description	Cena/ price
1011103	Set za povezivanje pumpe pompa mašinskom prostoru – pumpa do 1 HP Ø50 / Filter connection kit to the housing	150,90 €
1011104	Set za povezivanje pumpe mašinskom prostoru - pumpa do 3 HP Ø63 / Filter connection kit to the housing	182,40 €
1011105	Set za povezivanje pumpe mašinskom prostoru - pumpa do 4 HP Ø90 / Filter connection kit to the housing	335,00 €
1011170	Naknadni dodatak priključku usisa/protok sa ventilom I prodorom Ø50 / Further attack supplement inlet/outlet	115,60 €
1011171	Naknadni dodatak priključku usisa/protok sa ventilom I prodorom Ø63 / Further attack supplement inlet/outlet	134,30 €
1011107	Naknadni dodatak priključku usisa/protok sa ventilom I prodorom Ø75 / Further attack supplement inlet/outlet	223,10 €
1011108	Naknadni dodatak priključku usisa/protok sa ventilom I prodorom Ø90 / Further attack supplement inlet/outlet	345,90 €
1011119	Naknadni dodatak priključku usisa/protok sa ventilom I prodorom Ø110/ Further attack supplement inlet/outlet	386,80 €
1011110	Naknadni dodatak priključku usisa/protok sa ventilom I prodorom Ø125/ Further attack supplement inlet/outlet	339,90 €
1010023	By-pass za povezivanje Ø50 / By-pass connection Ø 50	135,20 €
1010024	By-pass za povezivanje Ø63 / By-pass connection Ø 63	150,30 €
1011111	By-pass za povezivanje Ø75 / By-pass connection Ø 75	164,30 €
1011112	By-pass za povezivanje Ø90 / By-pass connection Ø 90	238,60 €
1011113	By-pass za povezivanje Ø110 / By-pass connection Ø 110	272,30 €
1011114	By-pass za povezivanje Ø125 / By-pass connection Ø 125	384,90 €
1011115	By-pass za povezivanje 160 / By-pass connection Ø 160	769,20 €
1011116	By-pass za povezivanje Ø200 / By-pass connection Ø 200	2.714,30 €

Povezani proizvodi: ELEKTRONSKE TABLE POOL CONTROL - cod. da 1090606 a 1090614/ cod da 1090636 a 1090647

Comfort

KOMFORT BAZENA



5



Sadržaj

GREJANJE VODE / WATER HEATING

254 UVOD

TOPLOTNE PUMPE

256 BLUEFIRE JUNIOR
257 BLUEFIRE SENIOR E MASTER
258 INDIANA EVO-MINI
259 INDIANA EVO-E
260 INDIANA EVO-M
261 INDIANA EVO-P
262 INDIANA EVO-V
263 INDIANA EVO-INDUSTRIAL

TERMIČKI IZMENJIVAČI / HEAT EXCHANGERS

265 TERMIČKO IZMENJIVAČI OD TITANIUMA / TITANIUM HEAT EXCHANGERS
266 PREMONTIRANI TERMIČKI IZMENJIVAČI / PREASSEMBLED HEAT EXCHANGERS
267 TERMIČKI IZMENJIVAČI ČELIK INOX / STAINLESS STEEL HEAT EXCHANGERS
269 IZMENJIVAČI DUPLI TERMO ELEKTRIČNI ZA SPA / DOUBLE ELECTRIC HEAT EXCHANGERS FOR SPA

ELEKTRIČNI GREJAČI/ ELECTRIC HEATER

271 GREJAČI ČELIK INOX / STAINLESS STEEL ELECTRIC HEATERS
272 GREJAČI OD TITANIUMA / TITANIUM HEATERS

274 SOLARNI PANELI ECO-SPARK 40 / SOLAR PANEL ECO SPARK 40

278 ODVLAŽIVAČI VAZDUHA / DEHUMIDIFIERS

ELEKTROLIZA SOLI / ELECTROLYSIS OF SALT

281 AUTOCHLOR RP E RP-PH
282 OPREMA AUTOCHLOR RP E RP-PH/ACCESSORIES AUTOCHLOR RP E RP-PH
283 UNIKO E UNIKO PRO

DEZINFEKCIJA VODE

285 UNIKO MG
287 LAMPE NA UV-C / UV-C LAMPS
289 LAMPE UV SREDNJEG-NISKOGR PRITISKA / MEDIUM-LOW PRESSURE UV LAMPS

COMFORT POOL - COMFORT

TOPLITNE PUMPE / HEAT PUMPS



BLUEFIRE JUNIOR



BLUEFIRE SENIOR E MASTER



INDIANA EVO MINI



INDIANA EVO-E



INDIANA EVO-M



INDIANA EVO-P



INDIANA EVO-V



INDIANA EVO-INDUSTRIAL

IZMENJIVAČI TOPLOTE HEAT EXCHANGERS



SERIE D-KWT-TI TANIUM
TITANIUM D-KWT-TI SERIES



SERIE D-KWT-TI PREMONTIRANI
PREASSEMBLED D-KWT-TI SERIES



A70-A1000
IČELIK INOX IN
STAINLESS STEEL



SERIE XS IN ČELIK INOX
STAINLESS STEEL XS SERIES



SERIE EVO KERAMIČKI
CERAMIC EVO SERIES



SERIE EWX DUPLI ZA SPA
DOUBLE SPA EWX SERIES



SERIE D-EWT-EV IN
ČELIK INOX
IN STAINLESS STEEL



SERIE D-EWT-TI INTITANIO
TITANIUM D-EWT-TI SERIES

SOLARNI PANELI / SOLAR PANELS



ECO-SPARK

ODVLAŽIVAČI VAZDUHA AIR DEHUMIDIFIERS



WD 3.5
WD 4.5

ELEKTROLIZA SOLI SALT ELECTROLYSIS



AUTOCHLOR RP
AUTOCHLOR RP-PH



MAGNEZIJUM ANODE
MAGNESIUM ANODES



UNIKO E UNIKO PRO
ELEKTROLITSKI SISTEM
ELECTROLYTIC SYSTEM

DEZINFEKCIJA VODE SALT ELECTROLYSIS



UNIKO Mg
SA SOLIMA MAGNEZIJUMA



LAMPE ZRACI UV UV-C EASY UV
UVC RAY LAMPS EASY UV



LAMPE ZRACI UV-C 4 ALL
UVC RAY LAMPS 4 ALL



LAMPA UV
UV LAMP

TEMPERATURA BAZENA

Bazeni sadrže velike zapremine vode koje, da bi garantovale optimalnu funkciju istih, moraju biti održavane na konstantnoj temperaturi, bez obzira dali su bazeni smešteni napolju ili unutra.

Temperatura na koju dovesti i održati vodu zavisi od vrste aktivnosti koja se želi vršiti u bazenu i od stepena željenog komfora:

- bazen za takmičenje 22-24°C
- laka sportska aktivnost/razonoda 26-29°C
- bazen za decu/pred zagrevanje 28-30°C
- bazeni za terapeutusku upotrebu 29-35°C

Termičke disperzije jednog bazena (Fig 1) proizilaze iz više faktora: zbog isparavanja površinskog vode, zbog zračenja prema spoljnom ambijentu, zbog prenosa toplote strujanjem proizvedena kontaktom vazduha i vode, zbog prenosa kroz zidove bazena, zbog ubacivanja vode iz razloga dnevne zamene. Potrebne sile za podešavanje i održavanje temperature mogu biti isporučene raznim uređajima, kao što su toplotne pumpe, termički izmenjivači i solarni paneli. Odgovarajuće rešenje za specifični bazenbiće određenaod stanja iste kao što je : električna opremljenost, postojanje gasnog kotla ili traženje maksimalnog tehničkog odgovora u terminima energetske uštede i ekokompatibilnsoti.

THE POOL TEMPERATURE

Pools contain large volumes of water that, to ensure optimum usage of the same, must be maintained at a constant temperature, placed outdoors or indoors. The temperature at which bring and keep the water depends on the type of activities that must take place into the pool and on the degree of comfort you require:

- Competitive pool 22-24 ° C Light sport / leisure 26-29 ° C Children's pool / warm 28-30 ° C
- Swimming pools for therapeutic use 29-35 ° C

The thermal dispersion of a swimming pool (Fig. 1) is due to several factors: the water evaporation from the surface, by radiation towards the external environment, by convection produced by the contact between the air and the water, for transmission through the walls of the basin, for the introduction of water daily. The power needed to start-up system and maintaining the temperature may be provided by various devices, such as heat pumps, heat exchangers and solar panels. The appropriate solution to the pool will be determined by the specific conditions of the same such as: the availability supply, the pre-existence of a gas boiler or the pursuit of maximization of the technical response in terms of energy saving and environmentally-friendly.

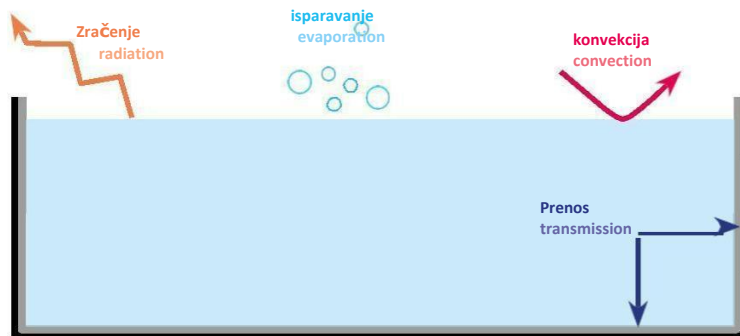

Fig 1: Termička dizperzija jednog bazena

Fig 1: Heat loss of a swimming pool

GREJANJE SA NISKOM POTROŠNJOM

Upoređujući razne grejne sisteme, onaj sa toplotnom pumpom smatra se najefikasnijim i najjeftinijim (Fig 2) zahvaljujući visokim vrednostima termičke efikasnosti (C.O.P.) koji takvi uređaji postižu.

HEATING WITH LOW CONSUMPTION

Comparing the different systems of heating, the heat pump is one of the most efficient and cost effective (Fig. 2) due to the thermal efficiency COP achieved by such devices.

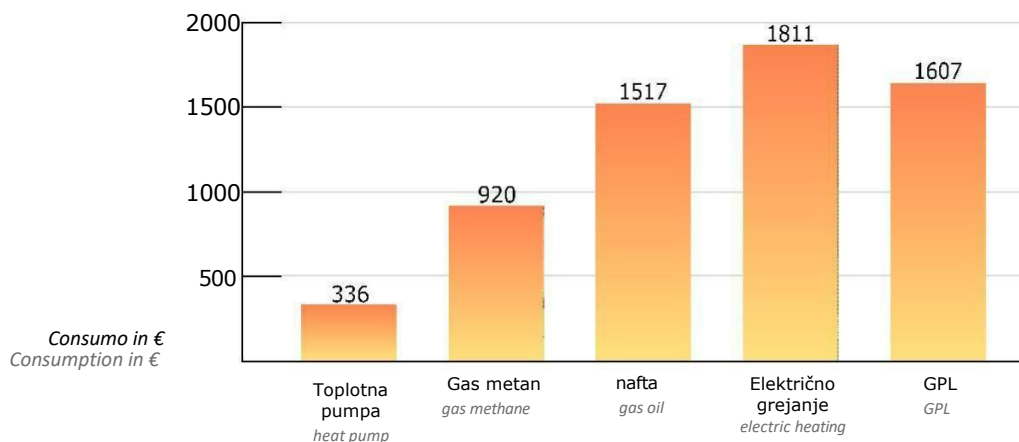

Fig2: Upoređenje koštanja između raznih grejnih sistema

Fig 2: Comparison of costs of heating systems

TOPLOTNA PUMPA U POSTROJENJU

Toplotna pumpa se spaja na filtracioni uređaj vode bazena. Kolo pumpe je povezano sa potiskom bazena (posle filtera) preko jednog by-pass a od tri ventila. Hladna voda, pošto je filtrirana, greje se unutar toplotne pumpe i pušta se u bazen. Zahvaljujući by-pass od tri ventila moguće je isključiti toplotnu pumpu, u slučaju održavanja i čišćenja, bez zaustavljanja filtracionog uređaja bazena (Fig. 3)



Fig 3: Schema di collegamento pompa e impianto

THE HEAT PUMPS IN SYSTEM

The heat pump must be connected to the water filtration system of the pool. The circuit of the pump is connected to the pool outlet (after the filter) through a by-pass with three valves. The cold water, after being filtered, is heated within the heat pump and fed into the pool. Thanks to the by-pass with three valves is possible to exclude the heat pump, in the case of maintenance and cleaning, without stopping the system of filtration of the pool (Fig. 3)

Fig 3: Schematic of connection pump and system

RAD TOPLOTNIH PUMPI

Toplotna pumpa je mašina sposobna da prenese toplotu iz tela sa nižom temperaturom na telo sa višom, koristeći električnu energiju. Toplotna pumpa vazduh/voda ne radi ništa drugo nego izdvaja energiju prisutnu u vazduhu i prenosi je u vodu u formi toplote.

Jedina energija koju sistem traži je ona upijena od strane, iako se mora imati u vidu da se upijena električna energija od kompresora sabira sa energijom uzetom iz vazduha, stvarajući zajedno toplotu za grejanje (25% cca). Toplotna pumpa (Fig. 4) je sastavljena od zatvorenog kruga, protočeno rashladnim tečnošću. Kolo se sastoji od četiri elementa kao što su isparivač, kompresor, kondenzator i organ valjanja, preko kojih rashladna tečnost trpi promene stanja koje omogućavaju transfer termičke energije. Kod isparivača vazduh greje rashladnu tečnost (1), hladeći se; od isparivača do kompresora tečnost dobija dodatni prinos energije u obliku pritiska i temperature (2). Po dolasku u kondenzator, rashlađivač trpi promenu stanja prepuštajući svoju toplotu vodi (3). Prisustvo jedne ekspanzione i regulacione sprave posle kondenzatora omogućava tečnosti za hlađenje da se vrati u isparivač i da otpočne ponovo ciklus hlađenja (4).

OPERATION OF THE HEATING PUMPS

The heat pump is a machine capable of transferring heat from a body at a lower temperature to a body at a higher temperature, using electrical energy.

The air/water heat pump extracts energy from the air and transfers it to the water in the form of heat.

The only energy that the system requires is absorbed by the compressor and fans, even if it is to keep in mind that the electric power absorbed by the compressor adds up the energy drawn from the air, together providing the heat for heating (about 25%).

The heat pump (Fig. 4) is constituted by a closed circuit with a special cooling fluid. The circuit consists in four components such as the evaporator, the compressor, the condenser and the expansion device, through which the refrigerant undergoes changes of state which make possible the transfer of thermal energy.

In the evaporator the air heats the refrigerant fluid (1), and cools; from the evaporator to the compressor fluid receives an additional intake of energy in the form of pressure and temperature (2). In the condenser, the refrigerant undergoes a change of state yielding its heat to the water (3). The presence of an organ expansion and regulation after the condenser allows the refrigerant to return to the evaporator and to recommence the cycle refrigerant (4).

4 Ekspanzioni ventil smanjuje pritisak tečnosti i ponovo ga rashlađuje

4 The expansion valve decreases the fluid pressure and cools again

Topla voda se vraća u bazen
Hot water to the pool

3 Voda bazena u kondenzatoru u kontaktu sa tečnošću, zagreje se

3 The water of the pool in the condenser in contact with the fluid, is heated

Hladna voda bazena
Water from th

2 Kompresor povećava pritisak tečnosti i dodatno utiče na povišenje temperature

2 The compressor increases the pressure of the fluid, and contributes to increase the temperature

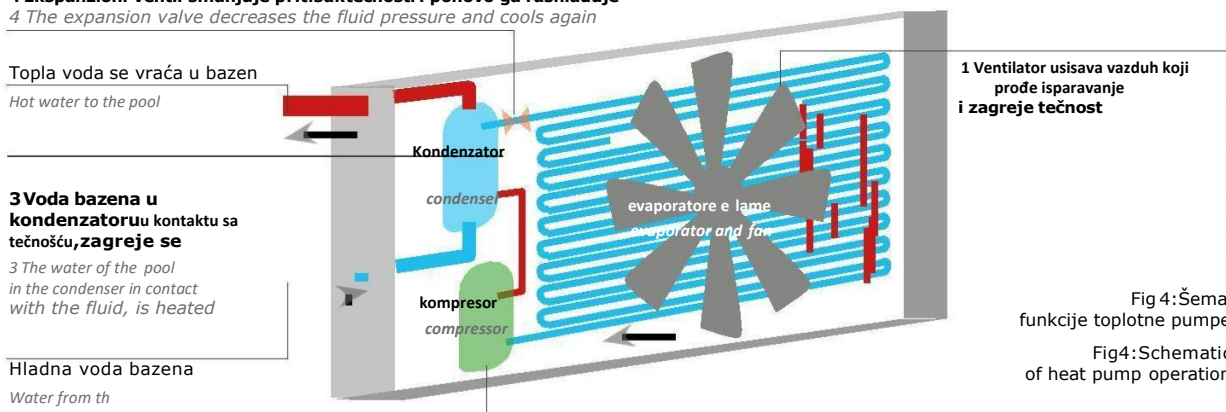

1 Ventilator usisava vazduh koji prođe isparavanje i zagreje tečnost

Fig 4: Šema funkcije toplotne pumpe

Fig4: Schematic of heat pump operation

TOPLOTNE PUMPE BLUEFIRE JUNIOR BLUEFIRE JUNIOR HEAT PUMPS



- Čelično telo prethodno farbano u pećnici
 - Konstantno grejanje i funkcija hlađenja
 - Titanijumski izmenjivač toplote sa visokom otpornošću na koroziju
 - Display LCD
 - Funkcija vremenskog paljenja i gašenja
 - Senzor protoka protiv praznog hoda
 - Zaštita od visokog/niskog pritiska
 - Automatsko odmrzavanje, garancija rada u ambijentima sa niskim temperaturama
- Stove pre-enamelling steel body
 - Constant heating and cooling function
 - Titanium heat exchanger with high resistance to corrosion
 - LCD display
 - Function on/off with timer
 - Flow sensor anti-idling
 - Protection high / low pressure
 - Auto defrost, guaranteed to work in cold environments

Šifra/ code	Opis/description	Alimen. Power supply [V/ph/Hz]	Cena/ price
1041130	Toplotna pumpa BluefireJuniorSBR-3.8H-Bfinoa15/20m3 HeatpumpBluefireJuniorSBR-3.8H-Bupto15/20m3	230/1/50	1.312,00 €
1041131	Toplotna pumpa BluefireJuniorSBR-5.3H-Bfinoa24/30m3 HeatpumpBluefireJuniorSBR-5.8H-Bupto24/30m3	230/1/50	1.493,00 €
1041138	Toplotna pumpa BluefireJuniorSBR-9.5H-Bfinoa30/40m3 HeatpumpBluefireJuniorSBR-9.5H-Bupto30/40m3	230/1/50	2.313,00 €
1041132	Toplotna pumpa BluefireJuniorSBR-11.3H-Bfinoa40/50m3 Heat pump Bluefire Junior SBR-11.3H-B up to 40/50 m3	230/1/50	2.886,00 €

KARAKTERISTIKE		SBR-3.8H-B	SBR-5.3H-B	SBR-9.5H-B	SBR-11.3H-B
Temperatura vazduha: 24°C; Vлага: 65%; Temperatura vode na ulazu: 27°C Air temperature: 24 ° C, Humidity: 65%, Inlet water temperature: 27 ° C					
Grejni kapacitet Heating capacity	kW	3,80	5,30	9,50	11,3
Nominalna potrošnja Heating input power	kW	0,79	1,08	1,94	2,35
Nominalna apsorpcija Heating running current	A	3,60	5,00	8,80	10,70
COP	-	4,8	4,9	4,9	4,8
R 410A težina/ R 410A weight	Kg	0,60	0,67	1	1,40
Prečnik spojeva (mm) / Water connection	mm	50	50	50	50
Termički izmenjivač / Heat exchanger	-	Titanium telo pumpe metal			
Tip kompresora / Compressor type	-	Rotativo / Rotary			
Napajanje / Power supply	V/PH/Hz	230/1/50	230/1/50	230/1/50	230/1/50
Zvučna emisija ad 1 m / Noise at 1 m	dBA	47	49	53	55
Protok / Water flow volume	m³/h	2-4	2-4	4-7	5-8
Gubljenje pritiska / Water pressure drop	Kpa	10	12	15	15
Dimenzije / Dimension	Largh / L	935	935	1010	1115
	Prof / W	360	360	370	470
	Altezza / H	520	520	585	690
Neto težina / Weight net	Kg	44	52	63	97
Zapremina bazena / Volume of pool	m	15/20 m³	24/30 m³	30/40 m³	40/50 m³

**TOPLLOTNE PUMPE BLUEFIRE SENIOR E MASTER
BLUEFIRE SENIOR AND MASTER HEAT PUMPS**



- Čelično telo prethodno farbano u peći sa display LCD
- Konstantno grejanje i funkcija hlađenja
- Izmenjivač toplote u titanijumu sa velikom otpornošću na koroziju
- Funkcija vremenskog paljenja i gašenja
- Senzor protoka protiv-praznog hoda
- Zaštita visoki/niski pritisak
- Automatsko odmrzavanje, garancija rada u ambijentu niske temperature
- *Stove pre-enamelling steel body with LCD display*
- *Constant heating and cooling function*
- *Titanium heat exchanger with high resistance to corrosion*
- *Function on/off with timer*
- *Flow sensor anti-idling*
- *Protection high / low pressure*
- *Auto defrost, guaranteed to work in cold environments*

Šifra/ code	Opis/description	Napon Power supply [V/ph/Hz]	Cena/ price
1041133	Toplotna pumpa Bluefire Senior SBR-14.0 H-B do 45/65 m ³ Heat pump Bluefire Senior SBR-14.0 H-B up to 45/65 m ³	230/1/50	3.477,00 €
1041134	Toplotna pumpa Bluefire Senior SBR-17.0 H-B do 60/80 m ³ Heat pump Bluefire Senior SBR-17.0 H-B up to 60/80 m ³	230/1/50	4.167,00 €
1041139	Toplotna pumpa Bluefire Senior SBR-17.0 H-B-S do 60/80 m ³ Heat pump Bluefire Senior SBR-17.0 H-B-S up to 60/80 m ³	400/3/50	3.836,00 €
1041136	Pumpa Bluefire Master SBR-26.0 H-B-S do 100/120 m ³ Heat pump Bluefire Master SBR-26.0 H-B-S up to 100/120 m ³	400/3/50	5.011,00 €

Caratteristiche		SBR-14.0 H-B	SBR-17.0 H-B	SBR-17.0 H-B-S	SBR-21.0 H-B-S	SBR-26.0 H-B-S	SBR-45.0 H-A-S
Temperatura vazduha: 20°C; Vlaga: 65%; Temperatura vode na ulazu: 27°C Air temperature: 20 ° C, Humidity: 65%, Inlet water temperature: 27 ° C							
Grejni kapacitet Heating capacity	kW	14	17	17	21,00	26,00	45,00
Nominalna potrošnja Heating input power	kW	2,91	3,70	3,70	4,55	5,65	9,9
Nominalna apsorpcija Heating running current	A	13,10	17,60	5,90 x 3	7,2 x 3	8,9 x 3	15 x 3
COP	-	4,8	4,6	4,6	4,6	4,6	4,5
R 410A težina / R 410A weight	Kg	1,64	1,80	1,80	2,43	2,60	2,30 x 2
Prečnik konekcija/ Water connection	mm	50	50	50	50	50	63
Termički izmenjivač / Heat exchanger	-	Titanio in scocca in metallo					
Vrsta kompresora / Compressor type	-	Rotativo / Rotary			Scroll		
Napajanje / Power supply	V/PH/Hz	230/1/50	230/1/50	400/3/50	400/3/50	400/3/50	400/3/50
Zvučna buka ad 1 m / Noise at 1 m	dB(A)	55	58	58	60	60	62
Protok / Water flow volume	m ³ /h	5-8	5-8	5-8	6-10	6-12	8-15
Gubitak pritiska / Water pressure drop	Kpa	15	16	16	16	16	18
Dimenzije / Dimension	Largh / L	mm	1115	1115	1115	1115	1450
	Prof / W		470	470	470	470	710
	Altezza / H		690	940	940	1250	1250
Neto težina / Weight net	Kg	120	132	132	143	145	255
Zapremina bazena / Volume of pool	m ³	45/63	60/80	60/80	70/95	100/120	160/200

TOPLOTNE PUMPE INDIANA EVO-MINI INDIANA EVO-MINI HEAT PUMPS



- Rotacioni kompresor
- Toplotni izmenjivač visoke efikasnosti
- Efikasna kontrola temperature sa display vizuozilatorom
- Zaštita od visokg pritiska
- Kompletna zaštita električnog kola
- Gas R32

- *Rotary compressor*
- *High efficiency heatexchanger*
- *Efficient temperature control with display visualization*
- *High pressure protection*
- *Full circuit protection*
- *R32 gas*

Šifra/code	Opis/description	Cena/price
1041444	INDIANA EVO MINI 05	758,30 €
1041445	INDIANA EVO MINI 08	866,40 €
1041446	INDIANA EVO MINI 12	996,10 €

MODEL / Model	MN05	MN08	MN12
Preporučena zapremina bazena (m ³) / advised pool volume (m ³)	15	20	30
Modalitet rada / Function mode	Grejanje /Heating		
Operativna temperatura (°C) / Operating air temperature (°C)	{10~43}		
USLOVI RADA(VAZDUH27°C/VODA26°C/VLAGA80%)/PERFORMANCECONDITION(AIR27°C/WATER26°C/HUMID.80%)			
Kapacitet grejanja (kW) / Heating Capacity (kW)	3.0	4.0	5.0
Potrošnja(kW)/Consumedpower(kW)	0.58	0.78	0.98
Koeficijent performansi / COP range	5.2	5.1	5.1
USLOVI RADA (VAZDUH 15°C/VODA 26°C/VLAGA 70%) / PERFORMANCE CONDITION (AIR 27°C/WATER 26°C/HUMID. 80%)			
Kapacitet grejanja (kW) / Heating Capacity (kW)	2.2	3.0	3.5
Potrošnja(kW)/Consumedpower(kW)	0.55	0.75	0.88
Koeficijent performansi / COP range	4.0	4.0	4.0
TEHNIČKE SPECIFIKACIJE / TECHNICAL SPECIFICATIONS			
Električno napajanje / Power Supply	230V/1Ph~/50Hz		
Telo / Casing type	ABS		
Hidraulični spojevi (mm) / Water Connection (mm)	32		
Broj ventilatora / Fan Quantity	1		
Broj kompresora / Compressor quantity	1		
Zvučni pritisakA1mdB(A)/SoundPressure1mdB(A)	46	46	46
Preporučeni protok vode (m ³ /h) / Advised Water Flow Volume (m ³ /h)	0.7	1.2	1.8

Nota: informacije vezane za sve modele Pumpi Indiana Evo mogu varirati po nahođenju urednika, bez upozorenja, kontekstualno sa ovim dokumentom, prema ispravkama predmetnog proizvoda: obaveza je kupca u trenutku narudžbe proveriti trajnost saobraznosti proizvoda informativnoj šemi. Gore navedeni podaci su samo informativni a za efektivnu vrednost imati u vidu pločicu sa oznakama zakačenu na svakoj pumpi pojedinačno. Ove pumpe mogu funkcionisati normalno unutar naznačenog temperaturnog intervala vazduha, efikasnost funkcionisanja neće biti garantovana van navedenog ranga. Molimo da se imaju u vidu da su performanse i parametri toplotne pumpe različiti zavisno od menjanja ambijentalnih uslova i instalacionih uslova. Navedeni parametri podložni su periodičnim ispravkama radi tehničkih poboljšanja bez prethodnog upozorenja. Za detalje pratiti pločicu za markaturu namenski prikačenu na svakoj pojedinačnoj toplotnoj pumpi. Eventualne šeme i slike prikazane u ovom dokumentu imaju samo informativnu vrednost.

TOPLOTNE PUMPE INDIANA EVO-E
INDIANA EVO-E HEAT PUMPS



- Rotacioni kompresor sa DC inverterom
- Spiralni toplotni izmenjivač visoke efikasnosti
- Soft starter
- Brzo odmrzavanje na topli gas sa 4položajnim ventilom
- Efikasna kontrola temperature sa display vizualizacijom
- Zaštita od visokog/niskog pritiska
- Kompletna zaštita električnog kola
- Gas R32
- DC inverter rotary compressor
- High efficiency spiral heat exchanger
- Soft starter
- Hot gas quick defrost with four-wayvalve
- Efficient temperature control with display
- High and low pressure protection
- Full circuit protection
- R32 gas



Toplotna pumpa inverter sa display controllertouch. Zahvaljujući inovativnoj kontroli tokova kombinovane razmene vazduha postiže nivo tišine po visokim standardima kvaliteta.

Inverterheatpumpwithtouchcontroller display. Thanks to an innovative control of the combined air exchange flows, it achieves a high standard of quietness



GasR3225%delR410a
25% gas quota of R410a



Rotacioni kompresor full inverter
Twin rotary compressor



Izmenjivač spiralni toplote od titanijuma
Twisted titanium heat exchanger

Šifra/code	Opis/description	Cena/price
1041441	INDIANA EVO E 30	2.487,10 €
1041442	INDIANA EVO E 40	3.162,10 €
1041443	INDIANA EVO E 50	3.608,60 €

MODEL /Model	E30	E40	E50
Preporučena zapremina bazena (m³) / advised pool volume (m³)	30~60	40~70	55~85
Modalitet rada / Function mode	Riscaldamento e raffreddamento/ Heating & Cooling		
Operativna temperatura (°C) / Operating air temperature (°C)	{0~43}		
USLOVI RADA (VAZDUH 27°C/VODA 26°C/VLAGA 80%) / PERFORMANCE CONDITION (AIR 27°C/WATER 26°C/HUMID. 80%)			
Grejni kapacitet (kW) / Heating Capacity (kW)	2.3~11.5	2.9~15.4	3.2~18.5
Potrošnja(kW)/Consumedpower(kW)	0.21~1.95	0.27~2.70	0.30~3.31
Koeficijent performansi / COP range	10.9~5.9	10.7~5.7	10.6~5.6
USLOVI RADA (ARIA 15°C/ACQUA 26°C/UMIDITÀ 70%) / PERFORMANCE CONDITION (AIR 27°C/WATER 26°C/HUMID. 80%)			
Grejni kapacitet (kW) / Heating Capacity (kW)	1.8~8.6	2.1~11.5	2.4~13.8
potrošnja(kW)/Consumedpower(kW)	0.28~1.91	0.33~2.61	0.38~3.28
Koeficijent performansi / COP range	6.4~4.5	6.3~4.4	6.3~4.2
TEHNIČKE SPECIFIKACIJE / TECHNICAL SPECIFICATIONS			
Električni napon / Power Supply	230V/1Ph~/50Hz		
Telo pumpe / Casing type	Čelo od ABS, leđa od metala / ABS front panel, metal back panel		
Kompresor / Compressor	Rotacioni Gree /Gree Rotary		
Hidraulični spoj (mm) / Water Connection (mm)	50		
Broj ventilatora / Fan Quantity	1		
Motor ventilatora / Fan motor	Dupla brzina / Dual speed		
Broj kompresora/ Compressor quantity	1		
Zvučni pritisak A 1 m dB(A) / Sound Pressure 1m dB(A)	41~51	43~53	44~54
Preporučeni protok vode (m³/h) / Advised Water Flow Volume (m³/h)	3.3	4.4	5.5
Gubitak pritiska(MAX)kPa/ WaterPressureDrop(max)kPa	3.8	4.8	4.8

COMFORTLY

TOPLOTNE PUMPE INDIANA EVO-M
INDIANA EVO-M HEAT PUMPS



Toplotna pumpa inverter sa display touch kontrolom i mogućnošću daljinske posvećene kontrole i lične wi fi mreže

- Rotacioni kompresor inverter DC
- Spiralni izmenjivač toplote visoke efikasnosti
- Kontrola WiFi via app
- Soft starter
- Brzo odmrzavanje toplim gasom sa 4 položajnim ventilom
- Efikasna kontrola temperature sa pregledom preko display
- Zaštita visokog i niskog pritiska
- Kompletna zaštita električnog kola
- Gas R32
- DC inverter rotary compressor
- High efficiency spiral heat exchanger
- WiFi control via app
- Soft starter
- Hot gas quick defrost with four-way valve
- Efficient temperature control with display visualization
- High and low pressure protection
- Full electrical circuit protection
- R32 gas



Gas R32 25% del R410a
25% gas quota of R410a



Rotacioni kompresor full inverter
Twin rotary compressor



Toplotni spiralni izmenjivač Od titanuma
Twisted titanium heat exchanger

Šifra/code	Opis/description	Cena/price
1041434	INDIANA EVO M 15	2.625,20 €
1041436	INDIANA EVO M 30	2.940,00 €
1041437	INDIANA EVO M 40	3.606,30 €
1041438	INDIANA EVO M 50	4.403,40 €
1041439	INDIANA EVO M 60	7.078,00 €
1041440	INDIANA EVO M 70T	7.971,00 €
1041456	INDIANA EVO M 80T	8.181,00 €

MODEL / Model	M15	M30	M40	M50	M60	M70T	M80T
Preporučena zapremina bazena (m ³) / advised pool volume (m ³)	15-40	30-55	40-75	45-90	55-105	60-120	100-200
Modaliitet rada / Function mode	Grejanje i hlađenje / Heating & Cooling						
Temperatura rada (°C) / Operating air temperature (°C)	(-7-43)						
USLOVI RADA (VZDUH 27°C/VODA 26°C/VLAGA 80%) / PERFORMANCE CONDITION (AIR 27°C/WATER 26°C/HUMID. 80%)							
Grejni kapacitet (kW) / Heating Capacity (kW)	1,6-7,5	2,5-12,0	3,1-16,0	3,70-20,0	6,5-24,3	7,1-28,2	8,15-35,1
Potrošnja (kW) / Consumed power (kW)	0,12-1,19	0,18-1,90	0,22-2,54	0,27-3,22	0,45-3,74	0,49-4,41	0,57-5,18
Koeficijent zaštite / COP range	13,8-6,3	14,1-6,3	13,9-6,3	13,8-6,2	14,5-6,5	14,3-6,4	14,3-6,8
USLOVI RADA (VAZDUH 15°C/ACQUA 26°C/UMIDITÀ 70%) / PERFORMANCE CONDITION (AIR 15°C/WATER 26°C/HUMID. 70%)							
Kapacitet grejanja (kW) / Heating Capacity (kW)	1,2-5,7	2,1-9,0	2,4-12,6	2,6-14,5	4,5-19,0	5,1-21,0	7,8-24,4
POTROŠNJA (kW) / Consumed power (kW)	0,17-1,21	0,29-1,91	0,34-2,73	0,38-3,15	0,62-3,88	0,71-4,38	1,07-5,55
Koeficijent performanse / COP range	7,1-4,7	7,1-4,7	7,0-4,6	6,9-4,6	7,3-4,9	7,2-4,8	7,3-4,4
TEHNIČKE OSOBINE / TECHNICAL SPECIFICATIONS							
Električno napajanje / Power Supply	230V~1Ph/50Hz					380V/3N~/50Hz	
Školjka / Casing type	Front od ABS, Leđa od metala / ABS front panel, metal back panel						
Kompresor / Compressor	Rotacioni inverter Mitsubishi / Mitsubishi Rotary inverter				Rotacioni inverter Panasonic / Panasonic Rotary Inverter		
HIDRAULIČNI PRIKLJUČAK (mm) / Water Connection (mm)	50						
BROJ VENTILATORA/ Fan Quantity	1						
Brzina ventilatora (rpm) / fan speed (rpm)	400-700	400-800	300-750	400-750	400-800		
Broj kompresora/ Compressor quantity	1						
Zvučni pritisak A 1 m dB(A) / Sound Pressure 1m dB(A)	38-47	40-49	41-52	42-53	44-55	45-56	47-57
Protok vode preporučeni (m ³ /h) / Advised Water Flow Volume (m ³ /h)	2,5	4,0	5,2	6,0	8,5	9,5	13,8
Gubitak pritiska (MAX) kPa / Water Pressure Drop (max) kPa	2,0	4,0	5,0	5,0	10,4	12,0	33,8

TOPLOTNE PUMPE INDIANA EVO-P INDIANA EVO-P HEAT PUMPS



- Rotacioni kompresor inverter DC
- Spiralni izmenjivač toplote visoke efikasnosti
- Kontrola WiFi preko app
- Soft starter
- Automatsko odmrzavanje smartcontrol
- Efikasna kontrola temperature preko displaya
- Zaštita od visokog i niskog pritiska
- Kompletna zaštita elektr.kola
- Gas R32
- *DC inverter rotary compressor*
- *High efficiency spiral heat exchanger*
- *WiFi control via app*
- *Soft starter*
- *Automatic defrosting with smart control*
- *Efficient temperature control with display*
- *High and low pressure protection*
- *Full circuit protection*
- *R32 gas*



Gas R32
R32 gas



Rotacioni kompresor
full inverter
Twin rotary compressor



Spiralni izmenjivač
toplote od titanijuma
Twisted titanium heat
exchanger

Šifra/code	Opis/description	Cena/price
1041429	INDIANA EVO P 30	4.279,00 €
1041431	INDIANA EVO P 50	6.779,00 €
1041432	INDIANA EVO P 60T	9.056,00 €
1041433	INDIANA EVO P 70 T	9.494,00 €

MODEL / Model	P30	P50	P60T	P70T
Preporučena zapremina bazen (m ³)/advised pool volume (m ³)	30-70	50-100	70-130	90-170
Modalitet rada / Function mode	Riscaldamento e raffreddamento / Heating & Cooling			
Operativna temperatura (°C) / Operating air temperature (°C)	(-15~43)			
USLOVI RADA (ARIA 27°C/ACQUA 26°C/UMIDITÀ 80%) / PERFORMANCE CONDITION (AIR 27%/WATER 26%/HUMID. 80%)				
KAPACITET GREJANJA (kW) / Heating Capacity (kW)	3.5~13.0	4.2~20.8	5.6~25.0	7.1~30.0
POTROŠNJA(kW)/Consumed power(kW)	0.22-1.81	0.26-2.78	0.34-3.38	0.44-4.17
Koeficijent performansi / COP range	16.2-7.2	16.4-7.5	16.5-7.4	16.1-7.2
USLOVI RADA (ARIA 15°C/ACQUA 26°C/UMIDITÀ 70%) / PERFORMANCE CONDITION (AIR 27°C/WATER 26°C/HUMID. 80%)				
Kapacitet grejanja (kW) / Heating Capacity (kW)	2.5-9.8	3.2-15.6	4.2-19.9	5.0-23.5
Potrošnja(kW)/Consumed power(kW)	0.32-1.88	0.41-2.94	0.53-3.83	0.66-4.61
Koeficijent performansi/ COP range	7.8-5.2	7.9-5.3	8.0-5.2	7.6-5.1
TEHNIČKES PECIFIKACIJE / TECHNICAL SPECIFICATIONS				
Električni napon / Power Supply	230V~/ 1ph/50Hz		380V/3N~/50Hz	380V/ 3N~50Hz
Telo pumpe/ Casing type	Lim sa mat finišom / matt-finished sheet metal			
Kompresor/ Compressor	Rotacioni inverter Mitsubishi / Mitsubishi Rotary inverter			
Hidraulični spoj (mm) / Water Connection (mm)	50			
Broj ventilatora / Fan Quantity	1			
Brzina ventilatora (rpm) / fan speed (rpm)	480-800			
Broj kompresora/ Compressor quantity	1			
Zvučni pritisak A1 mdB(A)/Sound Pressure 1mdB(A)	38-48.5	41-51	41-52	43-53
Preporučeni protok vode(m ³ /h)/Advised Water Flow Volume (m ³ /h)	5.5	8.0	9.5	10.5
Gubitak pritiska(MAX)kPa/Water Pressure Drop(max)kPa	3.5	8.0	10.5	12.5

TOPLOTNE PUMPE INDIANA EVO-V INDIANA EVO-V HEAT PUMPS



- Rotacioni inverter DC Kompresor
 - Spiralni izmenjivač toplote visoke efikasnosti
 - Kontrola WiFi putem app
 - Soft starter
 - Automatsko odmrzavanje smartcontrol
 - Efikasna kontrola temperature preko display
 - Zaštita od visokog i niskog pritiska
 - Kompletna zaštita električnog kola
 - Gas R32
- *DC inverter rotary compressor*
 - *High efficiency spiral heat exchanger*
 - *WiFi control via app*
 - *Soft starter*
 - *Automatic defrosting with smart control*
 - *Efficient temperature control with display visualization*
 - *High and low pressure protection*
 - *Full circuit protection*
 - *R32 gas*



Gas R32 25% del R410a
25% gas quota of R410a



Rotacioni kompresor
full inverter
Twin rotary compressor



Spiralni Izmenjivač
toplote od titaniuma
Twisted titanium heat
exchanger

Šifra/code	Opis/description	Cena/price
1041424	INDIANA EVO V 50	5.620,00 €
1041426	INDIANA EVO V 70T	7.281,00 €
1041425	INDIANA EVO V 80T	8.428,00 €

MODEL / Model	V50	V70T	V80T
Preporučena zapremina bazena (m ³) /advised pool volume (m ³)	42-84	60-120	66-136
Modalitet rada / Function mode	Riscaldamento e raffreddamento/ Heating & Cooling		
Radna temperatura (°C) / Operating air temperature (°C)	(-7~43)		
USLOVI RADA (ARIA 27°C/ACQUA 26°C/UMIDITÀ 80%) / PERFORMANCE CONDITION (AIR 27°C/WATER 26°C/HUMID. 80%)			
Kapacitet grejanja (kW) / Heating Capacity (kW)	5.2~20.6	8.5~28.0	10.4~32
Potrošnja(kW)/ Consumed power(kW)	0.38~3.2	0.60~4.3	0.77~4.9
Koeficijent performansi / COP range	13.6~6.5	14.2~6.5	13.5~6.5
USLOVI RADA (ARIA 15°C/ACQUA 26°C/UMIDITÀ 70%) / PERFORMANCE CONDITION (AIR 27°C/WATER 26°C/HUMID. 80%)			
Kapacitet grejanja (kW) / Heating Capacity (kW)	4.1~14.8	5.6~20.3	6.5~22.5
Potrošnja(kW)/ Consumed power(kW)	0.55~3.3	0.71~4.1	0.88~5.0
Koeficijent performansi / COP range	7.4~4.5	7.9~4.9	7.4~4.5
Tehničke specifikacije/ TECHNICAL SPECIFICATIONS			
Električni napon / Power Supply	230V~/1Ph/50Hz	380V/3N~/50Hz	380V/3N~/50Hz
Telo / Casing type	Galvanizirani čelik / Galvanized steel		
Kompresor / Compressor	Rotacioni inverter Panasonic / Panasonic rotary inverter		
Hidraulična konekcija (mm) / Water Connection (mm)	50		
Broj ventilatora/ Fan Quantity	1		
Brzina ventilatora (rpm) / fan speed (rpm)	500-750	600-800	
Broj kompresora / Compressor quantity	1		
Zvučni pritisak 1 m dB(A) / Sound Pressure 1 m dB(A)	44-55	47-58	48-60
Preporučeni protok vode (m ³ /h) / Advised Water Flow Volume (m ³ /h)	9.5	12.0	15.0
Gubitak pritiska(MAX)kPa/Water Pressure Drop(max)kPa	16.2	23.8	23.8

TOPLOTNA PUMPA INDIANA EVO-INDUSTRIAL
 INDIANA EVO-INDUSTRIAL HEAT PUMPS

- Kompresor scroll DC
- Toplotni spiralni izmenjivač visoke efikasnosti
- Soft starter
- Brzo odmrzavanje toplim gasom sa 4 položajnim ventilom
- Efikasna kontrola temperature sa pregledom na display
- Zaštita od visokog i niskog pritiska
- Kompletna zaštita električnog kola
- Gas R32
- DC scroll compressor
- High efficiency spiral heat exchanger
- Soft starter
- Hot gas quick defrost with four-way valve
- Efficient temperature control with display visualization
- High and low pressure protection
- Full circuit protection
- R32 gas

 Gas R32
 R32 gas

 Kompresor scroll
 Scroll compressor

 Izmenjivač toplote
 Titanium spirala
 Twisted titanium heat
 exchanger

Šifra/code	Opis/description	Cena/price
1041449	INDIANA INDUSTRIAL 8S*	14.473,00 €
1041450	INDIANA INDUSTRIAL 10S	15.426,00 €
1041451	INDIANA INDUSTRIAL 13S	17.053,00 €
1041453	INDIANA INDUSTRIAL 25S	37.473,00 €

* Artikel trenutno nije na raspolaganju

MODEL / Model	MC 08S	MC 10S	MC 13S	MC 25S
Preporučena zapremina bazena (m ³) / advised pool volume (m ³)	130	170	350	650
Modalitet rada / Function mode	Grejanje i hlađenje / Heating & Cooling			
Temperatura rada (°C) / Operating air temperature (°C)	(-15~43)			
USLOVI RADA (VAZDUH 27°C/VODA 26°C/VLAGA 80%) / PERFORMANCE CONDITION (AIR 27°C/WATER 26°C/HUMID. 80%)				
Gejni kapacitet (kW) / Heating Capacity (kW)	38,5	46,2	59,8	140,6
Potrošnja (kW) / Consumed power (kW)	6,23	8,41	9,84	23,35
Koeficijent performanse / COP range	6,1	5,50	6,1	6
USLOVI RADA (VAZDUH 15°C/VODA 26°C/VLAGA 70%) / PERFORMANCE CONDITION (AIR 15°C/WATER 26°C/HUMID. 70%)				
Gejni kapacitet (kW) / Heating Capacity (kW)	29,8	38,6	49,2	112,1
Potrošnja (kW) / Consumed power (kW)	6,23	7,28	9,84	23,35
Koeficijent performanse / COP range	4,8	5,3	5	4,8
TEHNIČKE OSOBINE / TECHNICAL SPECIFICATIONS				
Električno napajanje / Power Supply	380V/3N~/50Hz			
Ram / Casing type	Čelik inox 304 / Stainless steel 304			
Kompresor / Compressor	Sanyo Scroll			
Hidraulična konekcija (mm) / Water Connection (mm)	63			
Broj ventilatora / Fan Quantity	2		3	
Brzina ventilatora (rpm) / fan speed (rpm)	750		920	
Broj kompresora/ Compressor quantity	2		4	
Zvučni pritisak A 1 m dB(A) / Sound Pressure 1m dB(A)	59		60	
Preporučeni protok vode (m ³ /h) / Advised Water Flow Volume (m ³ /h)	12		24	
Gubitak pritiska (MAX) kPa / Water Pressure Drop (max) kPa	6,1		19,4	

IZMENJIVAČ TOPLOTE HEAT EXCHANGERS

BRZO GREJANJE

Izmenjivač toplote je po definiciji aparat u kojem je toplota prenešena iz jedne "tople" tečnosti, tj. veće temperature, u "hladnu" tečnost, manje temperature.

U slučaju bazena, izmenjivač se povezuje sa vodovima kućnog kotla, tako da već topla voda kotla može zagrijati onu iz bazena. To je srednje rešenje po pitanju troškova, sa potrošnjom koja varira zavisno od kućnog termičkog bilansa.

IZMENJIVAČ U SISTEMU

Voda teče u unutrašnjosti izmenjivača u suprotnim smerovima, putem dva kola (Fig 5):

- Primarno kolo: prenosi vodu kućnog grejnog sistema u izmenjivač.
- Sekundarno kolo: transportuje vodu bazena u izmenjivač da bi se zagrejala.

Prednosti su prepoznata pouzdanosti brzo grejanje: jednom povezan na kotao, bazen može biti zagrejan na 28°C za 24-48 sata.

A QUICK HEATING

The heat exchanger is by definition a device in which heat is transferred from a "hot" fluid, with a high temperature, to a "cold" fluid, at a lower temperature.

In the case of swimming pools, the heat exchanger is connected to the pipes of the boiler house, so that the already hot water of the boiler can warm that of the pool. It is an intermediate solution in terms of costs, with a consumption which varies as a function of the thermal balance home.

THE EXCHANGER IN THE SYSTEM

Water flows inside the exchanger in opposite directions, through two circuits (Fig 5):

- primary circuit: it carries water from home heating system to the heat exchanger
- secondary circuit: it carries the pool water in the heat exchanger and warms it up

The advantages are the reliability and the fast heating: once connected to a boiler, the pool can be heated to 28 °C within 24-48 hours.

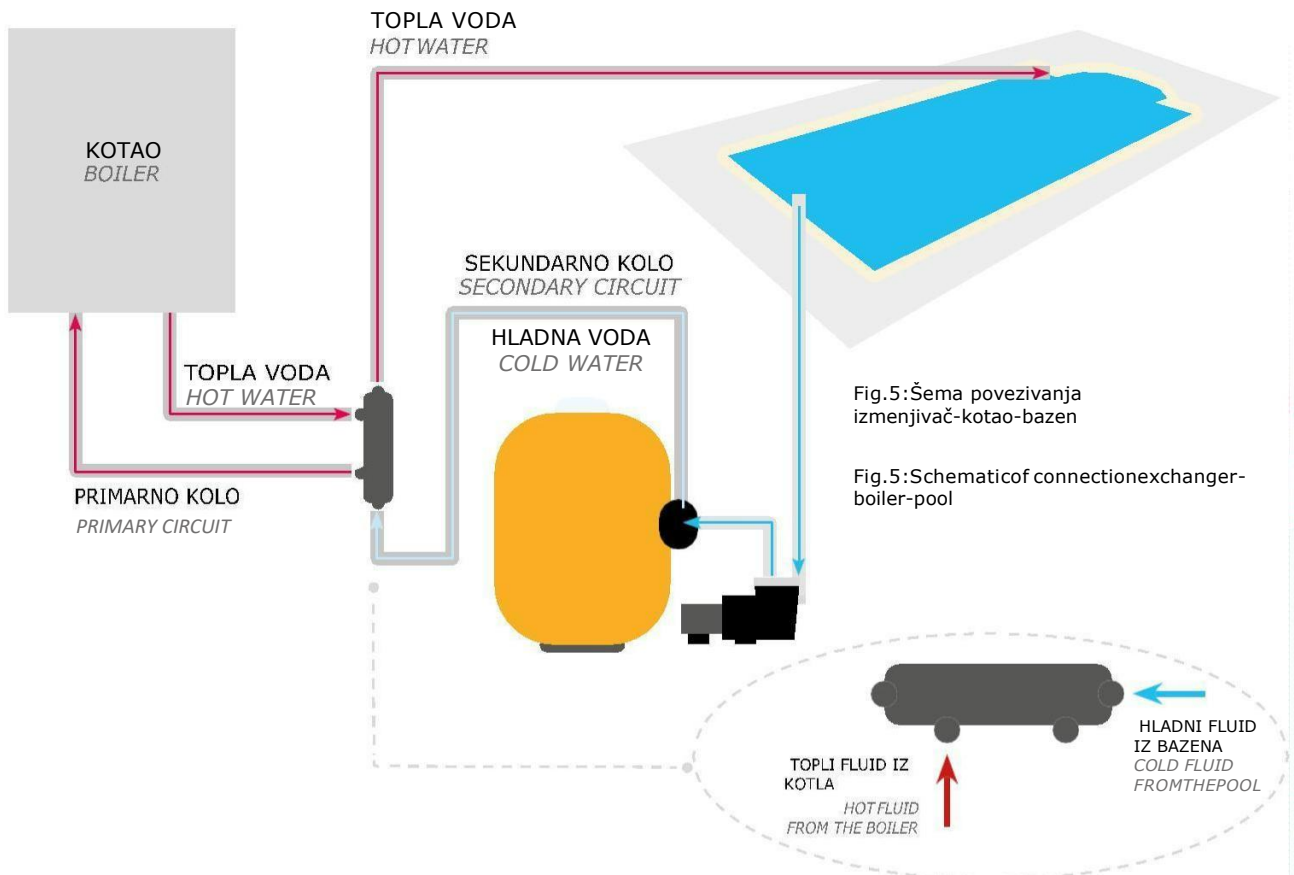

TITANIJUMSKI TERMIČKI IZMENJIVAČI SERIE D-KWT-TI
D-KWT-TI SERIES TITANIUM HEAT EXCHANGERS



D-KWT-Ti 25

- Izmenjivači od titanijske saplastičnimitelom
- Spojevi na lepljenje u ABS
- Prstenasti silikonski dihtunzi
- Valovita spirala od titanijuma
- Grejanje na kotao, solarnim uređajima, toplotnim pumpama ili uređajima niske temperature
- Temperatura max. 90°C

- Titanium heat exchangers with a plastic casing
- Gluing socket: ABS
- O-ring: silicon
- Corrugated tube: titanium
- Heating: from a boiler, solar collectors, a heat pump, or a low temperature heating system
- Maximum temperature 90° C

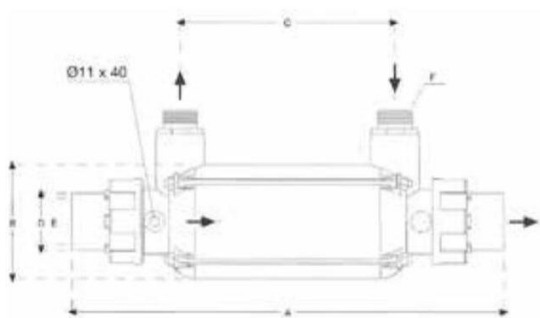

Šifra/ code	Opis/description	Cena/ price
1040536	Izmenjivač toplote D-KWT-Ti 25 Heat exchanger D-KWT-Ti 25	769,00 €
1040537	Izmenjivač toplote D-KWT-Ti 45 Heat exchanger D-KWT-Ti 45	890,00 €
1040538	Izmenjivač toplote D-KWT-Ti 85 Heat exchanger D-KWT-Ti 85	1.433,00 €
1040539	Izmenjivač toplote D-KWT-Ti 105 Heat exchanger D-KWT-Ti 105	1.976,00 €

Model	A [mm]	B [mm]	C [mm]	D [mm]	E [mm]	F [inch]
D-KWT-Ti 25	345	110	135	63	50	¾ "
D-KWT-Ti 45	415	110	205	63	50	¾ "
D-KWT-Ti 85	705	110	495	63	50	1"
D-KWT-Ti 105	1015	110	805	63	50	1"

Model	Kapacitet razmene [kW]		Površina razmene [m ²]	Protok primarnog kola [m ³ /h]	Gubitak pritiska primarnog kola [bar]	protok sekundarnog kola m ³ /h	Gubitak pritiska sekundarnog kola [m ³ /h]	Radni prit. max. grejanja [bar]	Radni max.prit. vode bazena [bar]
	80°C	60°C							
D-KWT-Ti 25	21,5	14,5	0,09	2	0,10	8	0,11	6 max.	2 max.
D-KWT-Ti 45	39	25	0,15	2	0,15	10	0,15	6 max.	2 max.
D-KWT-Ti 85	78	52	0,33	2	0,28	12	0,22	6 max.	2 max.
D-KWT-Ti 105	108	72	0,54	2	0,36	15	0,30	6 max.	2 max.

PREMONTIRANI IZMENJIVAČI SERIE D-KWT-TI COMPACT D-KWT-TI
COMPACT SERIES PREASSEMBLED HEAT EXCHANGERS

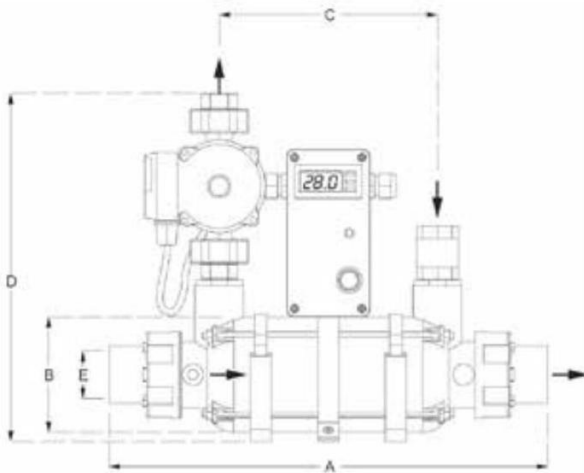

- Potpuno užičeno i opremljeno sa cirkularnom pumpom(sa tri brzine za primarno kolo),nepovratnim ventilom,prekidačem za paljenje/gašenje,kontrolna špijunkaLEDi regulator digitalno elektronski temperature (podesiv od0-40°C)
 - Upotreba:grejanje bazena,hidromasažne kade I wellness uređaji.
 - Lako se ugrađuje u filtraciono kolopreko plastične spojnice na lepljenje ø 50 mm
 - Plastični omotač
 - Valovita titanijumska spirala / čelik inox AISI 316
 - Napon: 230V / 50 Hz
 - Potrošnja energije: 0,34 A
 - IP - Code:IP54
- It is completely wired and is featured with a circulation pump (three step for the primary circuit), non return valve, on-off button, LED - control lamp and digital electric temperature regulation (adjustable from 0-40 °C)*
- Usage: to heat swimming pools, whirlpools and wellness facilities*
- The electric heat exchanger is easy to insert into the filtration circuit by means of a plastic nozzle ø 50*
- Material casing: plastic
 - Corrugated spiral in titanium / stainless steel AISI 316
 - Voltage: 230 V / 50 Hz
 - Power consumption level 3: 0,34 A
 - IP - Code: IP54

Šifra/code	Opis/description	Cena/price
104054	Izmenjivač titanijumski toplote D-KWT-Ti45 Compact Titanium heat exchanger D-KWT-Ti45 Compact	1.960,00 €
104054	Izmenjivač toplote inox D-KWT-VA45 Compact Inox heat exchanger D-KWT-VA 45 Compact	1.554,00 €
104054	Izmenjivač toplote titanium D-KWT-Ti85 Compact Titanium heat exchanger D-KWT-Ti85	2.302,00 €
104054	Izmenjivač toplote inox D-KWT-VA85 Compact Inox heat exchanger D-KWT-VA 85 Compact	1.863,00 €

Model	A [mm]	B [mm]	C [mm]	D [mm]	E [mm]
D-KWT-Ti/VA 45 Compact	415	110	205	345	ø 50
D-KWT-Ti/VA 85 Compact	705	110	495	-	ø 50

Model	Kapacitet razmene [kW]	Temperatura vode bazena 20°C	Površina za razmenu [m ²]	Protok primarnog kola [m ³ /h]	Gubitak pritiska primarno kolo [bar]	Protok sekundarnog kola [m ³ /h]	Gubitak pritiska sekundarno kolo [m ³ /h]	Radni Max.pritisak grejanja [bar]	Radni max.pritisak vode bazena [bar]
D-KWT-Ti/VA 45	39	25	0,15	2	0,15	10	0,15	6 max.	2 max.
D-KWT-Ti/VA 85	78	52	0,33	2	0,28	12	0,22	6 max.	2 max.

TERMIČKI IZMENJIVAČI ČELIK INOX STAINLESS
STEEL HEAT EXCHANGERS

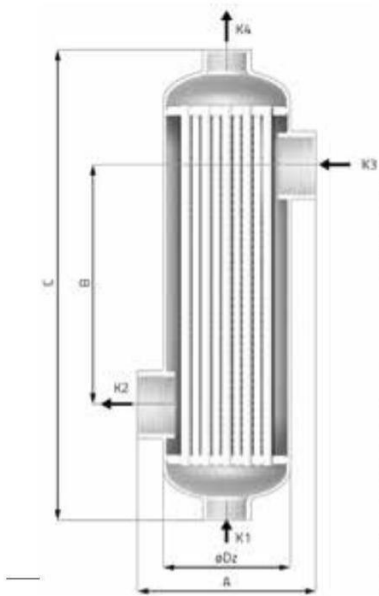

- Od inox čelika 316-L da bi se garantovala visoka otpornost na koroziju i duži vek trajanja.
- Projektovani da rade sa visokom brzinom protoka i malim gubitcima pritiska
- Sistem auto pranja
- *Stainless steel 316-L to ensure a superior corrosion resistance and a longer duration*
- *Designed to operate at high speed flow with low pressure drop*
- *Self-cleaning syste*

Šifra/ code	Opis/description	Cena/ price
104102	Izmenjivači toplote inox A70 A70 stainless steel heat exchanger	667,50 €
104102	Izmenjivači toplote inox A130 A130 stainless steel heatexchanger	704,50 €
104102	Izmenjivači toplote inox A180 A180 stainless steel heatexchanger	964,00 €
104102	izmenjivač toplote inox A250 A250 stainless steel heatexchanger	1.010,50 €
104102	Izmenjivač toplote inox A300	1.075,30 €
104102	Izmenjivač toplote inox A500	1.594,50 €
104102	Izmenjivač toplote inox A1000	2.642,00 €

Model	A [mm]	B [mm]	C [mm]	ØDz [mm]	Ø K2, K3 Kolo bazena	Ø K1, K4 Kolo kotla	Tež [kg]	Sup. di scambio [m ²]
A70	122,0	175,0	389,5	80,0	1½"	¾"	3,00	0,18
A130	122,0	225,0	439,5	80,0	1½"	¾"	3,30	0,23
A180	143,6	193,0	379,0	101,6	1½"	1"	4,60	0,38
A250	143,6	323,0	509,0	101,6	1½"	1"	5,80	0,55
A300	143,6	451,0	637,0	101,6	1½"	1"	7,30	0,73
A500	143,6	884,0	1103,0	101,6	2"	1"	12,40	1,37
A1000	190,0	598,0	943,0	139,7	2"	2"	23,50	1,97

Ulazna temp. kotao Heat source temp.inlet	Ulazna temp. bazena Pool water temp. inlet	Jed. units	A70	A130	A180	A250	A300	A500	A1000						
60°C	20°C	kW	22	26	36	44	50	59	61	75	96	110	145	165	275
		Kcal/h	18.916	22.355	30.954	37.833	42.992	50.730	52.450	64.488	82.545	94.582	124.677	141.874	236.457
90°C	20°C	kW	40	50	66	80	92	110	115	135	174	200	250	300	500
		Kcal/h	34.393	42.992	56.749	68.787	79.105	94.582	98.882	116.079	149.613	171.969	124.677	257.953	429.922
PROTOK Flow	kolo bazena poolwater	m ³ /h	12	12	12	15	12	15	12	15	12	13	15	15	20
	kolo kotla heat	m ³ /h	3	3	4	5	4	5	4	5	4	5	4	5	10
Gubitak pritiska Pressure drop	kolo bazena pool water	kPa	12	15	7	11	10	14	12	18	19	22	7	7	12
	kolo kotla heat	kPa	3	4	2	3	3	5	4	6	5	7	2	3	9
Zapremina bazena / pool capacity	m ³		15-25	25-40	40-55	55-75	75-90	90-160	140- 280						
Attacco circuito piscina Konekcija bazenskog kola	Ø		1"1/2	1"1/2	1"1/2	1"1/2	1"1/2	2"	2"						
konekcija kola kotla	Ø		3/4"	3/4"	1"	1"	1"	1"	2"						

TERMIČKI IZMENJIVAČI

TERMIČKI IZMENJIVAČI ČELIK INOX INOX XS STAINLESS STEEL XS HEAT EXCHANGERS



- Od inox čelika 316 radi garantovanja veće otpornosti na koroziju i duži rok trajanja
- Glavčine demontažne za čišćenje oklopnih cevi
- Savetuje se da se uradi uzemljenje

- *Stainless steel 316 to ensure a superior corrosion resistance and a longer duration*
- *Removable heads for cleaning*
- *It is recommended to operate the grounding*

Inox izmenjivači nisu kompatibilni sa aparaturama elektrolize
The stainless steel exchangers are not compatible with the equipment of electrolysis

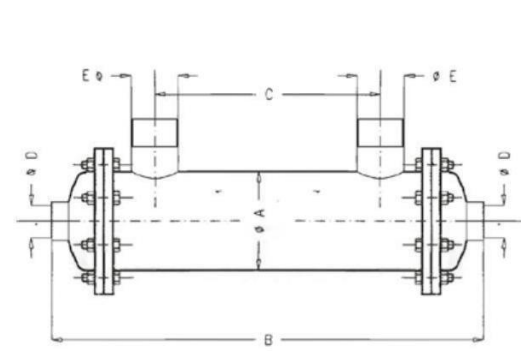

Šifra/ code	Opis/description	Cena/ price
104012	Izmenjivač toplote xs 120.000kcal/h Heatexchangerxs120.000kcal/h	2.544,00 €
104012	Izmenjivač toplote xs 150.000kcal/h Heatexchangerxs150.000kcal/h	3.191,00 €
104012	Izmenjivač toplote xs 180.000kcal/h Heatexchangerxs180.000kcal/h	3.432,00 €
104012	Izmenjivač toplote xs 200.000kcal/h Heatexchangerxs200.000kcal/h	3.739,00 €

Model	ØA [mm]	B [mm]	C [mm]	ØD [mm]	ØE [mm]
1040120	114	724	490	50 F	63 M
1040121	129	784	540	63 F	63 M
1040122	129	854	600	63 F	75 M
1040123	129	904	640	63 F	75 M

Priklj.	1040120	1040121	1040122	1040123
Ø Priključak na kolo bazena	2"	2"	2" ½	2" ½
Ø Priključak na kolo kotla	1 1/2"	2"	2"	2"

*Vrednosti, reprodukovane slike i šeme predstavljeni su samo kao informacija.

*Values, images and diagrams reproduced are shown only for information.

DUPLI TERMIČKI IZMENJIVAČI

TERMIČKO ELEKTRIČNI DUPLO IZMENJIVAČI ZA SPA SERIJE EWX EWX SERIES DOUBLE ELECTRIC HEAT EXCHANGERS FOR SPA

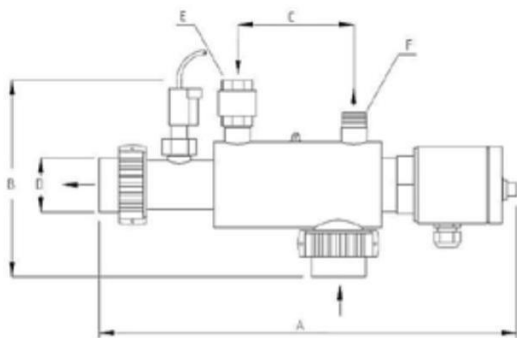

- EWX je toplotni izmenjivač Dvojne Upotrebe sposoban da zagreje vodu bazena i na električni način putem otpora ili razmenom toplote putem namotanih cevi.
- Može se takođe pustiti u funkcijusa oba sistema uporedo da bi značajno povećao snagu aparata.
- Koristi izabrani izvor energije i dodaje onu preostalu u slučaju potrebe.
- Serijski isporučen sa prekidačem za protok vode kao sigurnosnim uređaj em u slučaju nedostatka protoka vode, sa sigurnosnim termostatom 55°C sa otporom Incoloy 800 visokotpornim na koroziju, IPX5
- S lakoćom se ubacuje u vodeno kolo putem plastičnog spoja na lepljenje D.50.
- Osmišljen zbog potreba skućenog prostora, ovaj izmenjivač Dvojne Upotrebe odgovara uređajima spa, hidromasažnim kadama, ribljim akvarijumima i sličnim uređajima malih dimenzija.
- *EWX is a Dual Heat Exchanger that can heat up bathing water by either using the heating element or by exchanging heat through the coiled tube.*
- *It can also be operated with both systems at the same time which rises the capacity considerably.*
- *Use the preferred energy source and add the other one when needed.*
- *It is equipped (standard) with a flow switch for slow water protection, a safety thermostat 55°C, and with a highly corrosion resistant heating element Incoloy 800, IPX5.*
- *Easily inserted into the water circuit by means of a D.50 adhesive plastic nozzle.*
- *They are made to save space and suited for whirlpools, fish tanks, and similar small devices.*

Šifra/ code	Opis/description	Cena/ price
1040555	Izmenjivač E2WX dupli električni 2 kW - voda/voda 7kW Electric heat exchanger 2 kW - E2WX	230 v 825,50 €
1040556	Izmenjivač E3WX dupli električni 3 kW - voda/voda 7kW Electric heat exchanger 3 kW - E3WX	230 v 846,40 €
1040557	Izmenjivač E5WX dupli električni 5 kW - voda/voda 7kW Electric heat exchanger 5 kW - E5WX	230 v 879,50 €
1040558	Izmenjivač E3WX dupli električni 3 kW - voda/voda 7kW Electric heat exchanger 3 kW - E3WX	400 v 935,30 €

Šifra	Model	A [mm]	B [mm]	C [mm]	D [mm]	E [inch]	F [inch]
1040555	E2WX - 1 ~	435	200	220	Ø50	¾" IG	¾" AG
1040556	E3WX - 1 ~	435	200	220	Ø50	¾" IG	¾" AG
1040557	E5WX - 1 ~	435	200	220	Ø50	¾" IG	¾" AG
1040558	E3WX - 3 ~	435	200	220	Ø50	¾" IG	¾" AG

TERMIČKE I ELEKTRIČNE KARAKTERISTIKE/ HEAT AND ELECTRIC FEATURES

karakteristike	E2WX / 230V	E3WX / 230V	E5WX / 230V	E3WX / 3x400V
Termičko električni kapacitet / Heat capacity electric	2 kW	3 kW	5 kW	3 kW
Potrošnja / Power consumption	8,8 A	12,9 A	21,5 A	4,3 A
Napajanje / Voltage	230 V	230 V	230 V	400 V
Frekvencija / Frequency	50/60 Hz			
Senzor protoka / Flow switch	max.1A / 230VAC			
Max. Pritisak primarnog kola / max. pressure primary	10 bar			
Max.Pritisak sekundarnog kola/max.pressure secondary	3 bar			
Termički kapacitet razmene / Capacity water heater	70°C / 7 kW 50°C / 3 kW			
Protok primarnog kola / Pump capacity primary	0,9m ³ /h			
Max.Temperatur primarnog kola/Max.temperature primary	70°C P /			
Kapacitet sekundarnog kola Pump capacity secondary	6 m ³ /h			

TERMIČKO ELEKTRIČNI GREJAČI OD ČELIKA INOX SERIE D-EWT-EV
D-EWT-EV SERIES STAINLESS STEEL ELECTRIC HEATER



- Od Inox čelika AISI316radi garancije veće otpornosti na koroziju i duži vek trajanja.
- Otpornost Incoloy 825 visokootporni na koroziju.
- Regulatorni termostat 0-40°C e sigurnosni termostat 55°C
- Za instalaciju u filtraciono kolo namenski su osmišljena dve inovativne plastične spojnice na lepljenje Ø 50mm.
- Pogodan za fiksne i mobilne uređaje.
- *Stainless steel 316-L to ensure a superior corrosion resistance and a longer duration.*
- *Highly corrosion proof heating rods made out of Incoloy 825.*
- *With control thermostat 0-40 °C and safety thermostat 55 °C.*
- *To connect them in the filtration circuit, two new and innovative gluing sockets ø 50 mm.*
- *It works perfectly for permanent and mobile facilities.*

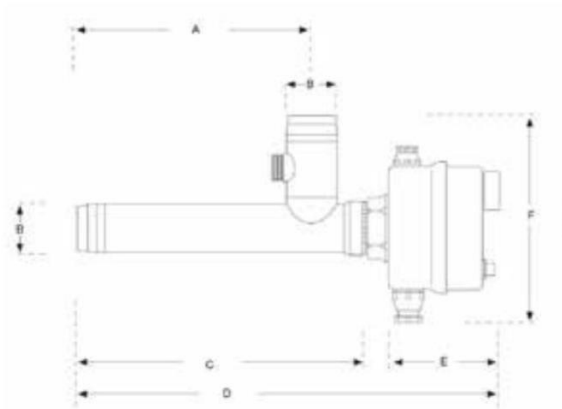

Šifra/ code	Opis/description	cena/ price
104052	Električno grejanjeinoxD-EWT-EV1,5 Inoxelectric heat exchanger D-EWT-EV 1,5	665,30 €
104052	Električno grejanje inox D-EWT-EV 3 Inox electric heat exchanger D-EWT-EV 3	674,80 €
104052	Električno grejanje inox D-EWT-EV 6 Inox electric heat exchanger D-EWT-EV 6	708,80 €
104052	Električno grejanje inox D-EWT-EV 9 Inox electric heat exchanger D-EWT-EV 9	724,30 €
104052	Električno grejanje inox D-EWT-EV 12 Inoxelectric heat exchanger D-EWT-EV 12	730,10 €
104052	Električno grejanje inox D-EWT-EV 15 Inoxelectric heat exchanger D-EWT-EV 15	741,20 €
104052	Električno grejanje inox D-EWT-EV 18 Inoxelectric heat exchanger D-EWT-EV 18	764,60 €

Model	A [mm]	B [mm]	C [mm]	D [mm]	E [mm]	F [mm]
D-EWT-EV 1,5	293	ø 50	345	475	110	255
D-EWT-EV 3	293	ø 50	345	475	110	255
D-EWT-EV 6	363	ø 50	415	545	110	255
D-EWT-EV 9	363	ø 50	415	545	110	260
D-EWT-EV 12	453	ø 50	505	635	110	260
D-EWT-EV 15	553	ø 50	605	735	110	270
D-EWT-EV 18	653	ø 50	705	835	110	270

karakteristike	D-EWT-EV 1,5	D-EWT-EV 3	D-EWT-EV 6	D-EWT-EV 9	D-EWT-EV 12	D-EWT-EV 15	D-EWT-EV 18
Termički kapacitet / Heat capacity	1,5kW	3 kW	6 kW	9 kW	12 kW	15 kW	18 kW
Kapacitet pumpe min. Min. pump capacity	2800l/h	2800 l/h	2800 l/h	2800 l/h	2800 l/h	2800 l/h	2800 l/h
Pritisak/Pressure	max. 3bar	max. 3 bar	max. 3 bar	max. 3 bar	max. 3 bar	max. 3 bar	max. 3 bar
Potrošnja~3ph-400V Power consumption at ~3 ph - 40	2,2A	4,3 A	8,7 A	13 A	17,3 A	21,7 A	26 A
Potrošnja~1ph-230V	6,6A	12,9 A	26,1 A	-	-	-	-

COMFORTLY

TERMIČKO ELEKTRIČNI GREJAČI U TITANIJUMU SERIE D-EWT-TI D-EWT-TI SERIES TITANIUM ELECTRIC HEATER



- Pogodni za sve bazene na slanu vodu, morsku, za wellness ili fizioterapeutske, gde visoka koncentracija soli ne sme predstavljati problem.
- Regulatorni termostat 0-40°C i sigurnosni termostat 55°C
- Za instalaciju u filtraciono kolo namenski su osmišljene dve inovativne plastične spojnice na lepljenje Ø 50 mm.
- Pogodan za fiksne i mobilne uređaje.
- *Offer absolute corrosion resistance, even for seawater. They are perfectly suited for all swimming pools getting sanitized with salt, as well as any pools for which a high concentration of salt is necessary, like for brine pools and all wellness and therapy pools.*
- *With control thermostat 0-40 °C and safety thermostat 55 °C*
- *To connect them in the filtration circuit, two new and innovative gluing sockets ø 50 mm.*
- *It works perfectly for permanent and mobile facilities.*

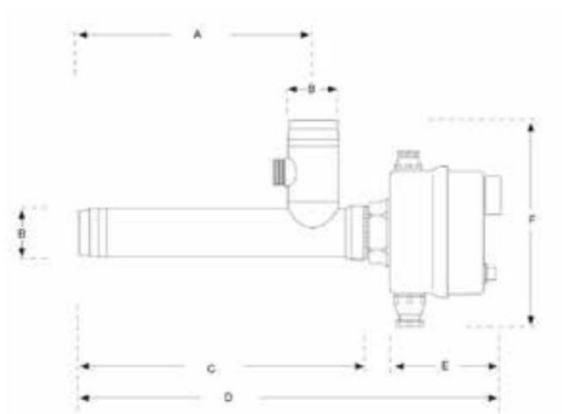

Šifra/ code	Opis/description	Cena/ price
104053	Titanijumski električni grejač D-EWT-Ti3 Titaniumelectric heatexchanger D-EWT-Ti 3	1.085,80 €
104053	Titanijumski električni grejač D-EWT-Ti6 Titaniumelectric heatexchanger D-EWT-Ti 6	1.095,10 €
104053	Titanijumski električni grejač D-EWT-Ti9 Titaniumelectric heatexchanger D-EWT-Ti 9	1.160,60 €
104053	Titanijumski električni grejač D-EWT-Ti12 Titaniumelectric heatexchanger D-EWT-Ti 12	1.174,30 €
104053	Titanijumski električni grejač D-EWT-Ti18 Titaniumelectric heatexchanger D-EWT-Ti 18	1.320,50 €

Model	A [mm]	B [mm]	C [mm]	D [mm]	E [mm]	F [mm]
D-EWT-Ti 3	293	ø 50	345	455	110	255
D-EWT-Ti 6	363	ø 50	415	525	110	255
D-EWT-Ti 9	363	ø 50	415	525	110	260
D-EWT-Ti 12	453	ø 50	505	615	110	260
D-EWT-Ti 18	653	ø 50	705	815	110	270

karakteristike	D-EWT-Ti 3	D-EWT-Ti 6	D-EWT-Ti 9	D-EWT-Ti 12	D-EWT-Ti 18
Termički kapacitet / Heat capacity	3 kW	6 kW	9 kW	12 kW	18 kW
Kapacitet pumpe min. Min. pump capacity	2800 l/h	2800 l/h	2800 l/h	2800 l/h	2800 l/h
Pritisak/Pressure	max. 3 bar	max. 3 bar	max. 3 bar	max. 3 bar	max. 3 bar
Potrošnja~3ph-400V Powerconsumptionat~3ph-400V	4,3	8,7A	13A	17,3A	26A
Potrošnja~1ph-230V Powerconsumptionat~1ph-230V	12,9A	26,1A	-	-	-

EKOPODRŽIVO GREJANJE

Solarna tehnologija omogućava (ako klimatske promene dozvole) da se produži vreme upotrebe bazena, produžavajući ga i van letnje sezone, koristeći obnovljivu sunčanu energiju. U mnogim slučajevima iskoristivost bazena opremljenog solarnim grejanjem može se kretati **od početka meseca maja do septembra oktobra**: tokom dana voda dostiže i održava prijatnu temperaturu, između 25 i 28° C.

Pogonska rešenja

Imajući u vidu komplikovane varijabile koje se aktiviraju u prisustvu velikih zapremina vode, kao npr. gubitak toplote noću, **ad hoc** je potrebno dimenzionirati uređaj.

To je **sistem prinudne cirkulacije**, urađen u plastici, kroz koji cirkuliše voda bazena, bez potrebe predviđanja izmenjivača toplote.

Za bazene malih i velikih dimenzija može se koristiti, za **cirkulaciju vode**, jedna jedinstvena pumpa lakim povetivanjem by-pass: dovodi se voda iz bazena do panela, ulazi odozdo i cirkuliše kroz cevi, gde se greje sunčanim zracima. Voda se posle kontinuirano vraća u bazen. (Fig 7).

Velika ekonomska prednost i ugradnje ovih sistema ogleda se u činjenici **da ne treba imati jedan rezervoar za skladištenje**, pošto i sam bazen ima funkciju rezervoara.

A SUSTAINABLE HEATING

Solar technology allows (variable weather permitting) to extend the period of use of the pool, extending outside of the summer season, using renewable energy from the sun. In many cases, the usability of a swimming pool with solar heating can go from the beginning of May until September- October: during the day the water reaches and maintains comfortable temperatures, between 25 and 28° C.

SYSTEM SOLUTIONS

Considering the complex variables that come into play in presence of considerable volumes of water, such as heat losses during the night, it is necessary to appositely dimension the plant.

It's a forced circulation system, made of plastic material, inside which passes the same water of the pool, without the need to provide a heat exchanger.

For small and medium-sized pools, a single pump with a simple by-pass connection can be used for water circulation:

the water is brought from the pool to the panels, enters from below and circulates in the pipes, where it is heated by sunlight. The water then returns to the pool continuously (Fig. 7).

A major economic and plant-engineering advantage of these systems lies in the fact that it is not necessary to have a storage tank, as it is the pool itself to perform the function of a tank.

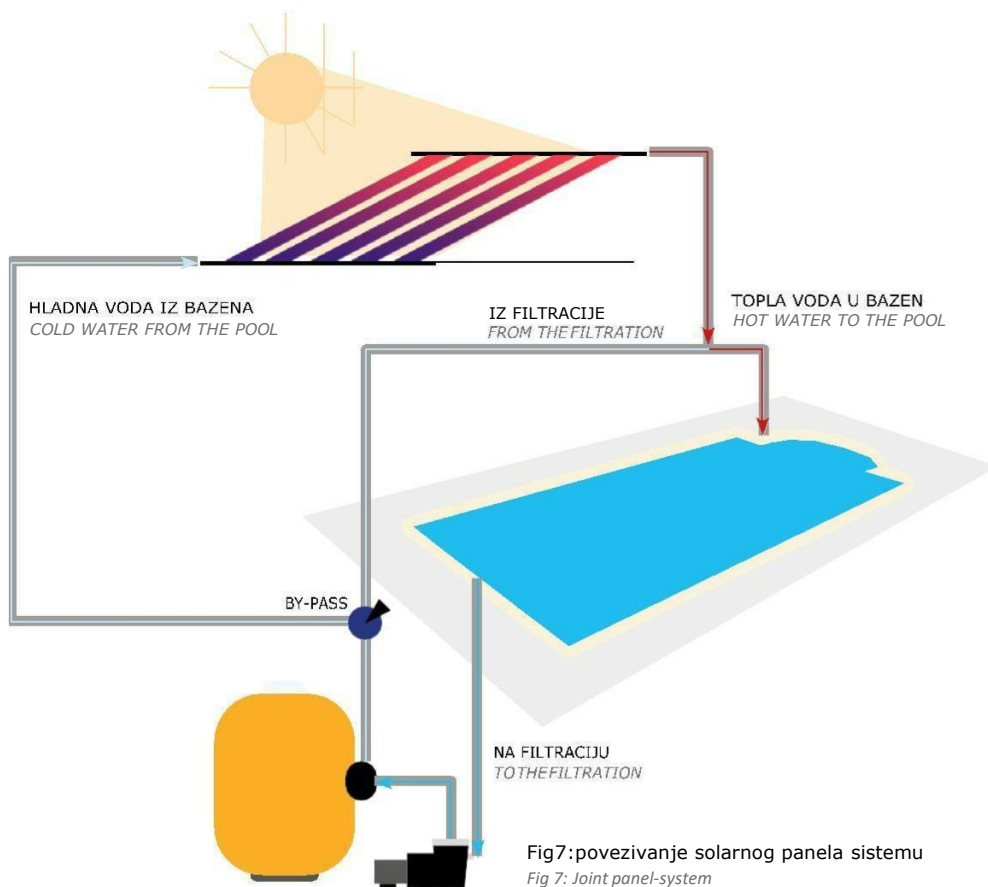

Fig7:povezivanje solarnog panela sistemu
Fig 7: Joint panel-system

COMFORTLY

EKO SOLARNI PANELI-SPARK 40
SOLAR PANEL ECO SPARK 40

- polimerički materijal namenski tretiran protiv efekata toplote, U.V. zrakai nepovoljnih klimatskih uslova.
- boja: crna
- dimenzije: 3,23 x 1,20 m – Površina: 3,85 m²
- težina kolektora na prazno: 17 Kg
- težina punog kolektora: 28,7 Kg
- zapremina vode po panelu: 11,7 litara
- maksimalni broj panela u jednom redu: 12
- protok preporučeni u panelima: cca 900 l/h po panelu
- pozicioniranje: zemlja ili krov
- orijentacija: Jug ili Jug-Zapad
- potrebna površina: 60% površine bazena za orijentir na Jug i na 30° nagutosti
- energetski učinak: temperaturavode 35°C --> 37.000kJ/dan, cca 0,428 kw/h
- temperatura maksimalna 80°C

- *Molymer material specially treated against the effects of heat, the UV and adverse weather conditions*
- *color: black*
- *dimensions: 3.23 x 1.20 m - Area: 3,85 m²*
- *weight of a vacuum manifold: 17 Kg*
- *weight of a manifold at full load: 28.7 kg*
- *volume of water for panel: 11.7 liters*
- *maximum number of panels in a single row: 12*
- *water flow rate recommended in the panels: about 900 l / h for panel*
- *placement: floor or roof*
- *orientation: South or South-West*
- *area required: 60% of the surface of the pool for an orientation to the south and 30° tilt*
- *energy efficiency: water temperature 35 ° C -> 37 000 kJ / day, about 0.428 kw / h*
- *maximum temperature 80 ° C*

Šifra/ code	Opis/description	Cena/ price
104038	Solarni panel EKO-SPARK crni- jedinica Solarni panel Eco-Spark black - one	900,00 €



KARAKTERISTIKE/ SPECIFICATIONS

Višestruko Inekciono livenje
Inekcioni proces spaja cevi sa gornjom stranom kolektora

Superimposed injection molding
injection process connects the tubes with the upper part of the collector

Gornji deo četvrtast
design četvrtasti omogućava montažu panela na svakoj vrsti krova
The top square
square design allows the mounting of the panel on any type of roof

Zaptivanje panela
mehanizam koji omogućava ekspanziju ili kontrakciju panela i u isto vreme onemogućava ulaz vode i prašine u staklo
Sealing panel
Mechanism that allows the expansion or contraction of the panel and simultaneously prevents the ingress of water and dust in the glass

Modularna struktura
Omogućava brzu i stabilnu konekciju između panela. Montaža jednostavna i brza
Modular structure
Allows fast and robust connection between the panels. Quick and easy installation

PC staklo
Presvučeno sa trajnim slojem protiv UV, obezbeđuje providnost za dug vremenski period
PC glass
Coated with anti uv durable layer, ensures transparency for a long period of time

Inkapsulacija staklenog saća
proizvodi efekat staklenika i izolaciju za svaku pojedinačnu cev. Značajno poboljšava termičku efikasnost panela.

Alveolar glass encapsulation
Produces the greenhouse effect and isolation for each tube. Significantly improves the thermal efficiency of the panel

Konekcije

Polimeran materijal, ojačavaju kolektor, održavajući konstantan razmak između modula omogućujući apsorpciju sila izazvanih jakim vetrovima.
Connections
polymeric material, reinforcing the collector, maintaining a constant spacing between the modules and allowing the absorption of the forces caused by strong winds

GUBITAK PRITISKA I PROTOKA / PRESSURE DROP AND FLOW RATE SPECIFICATIONS

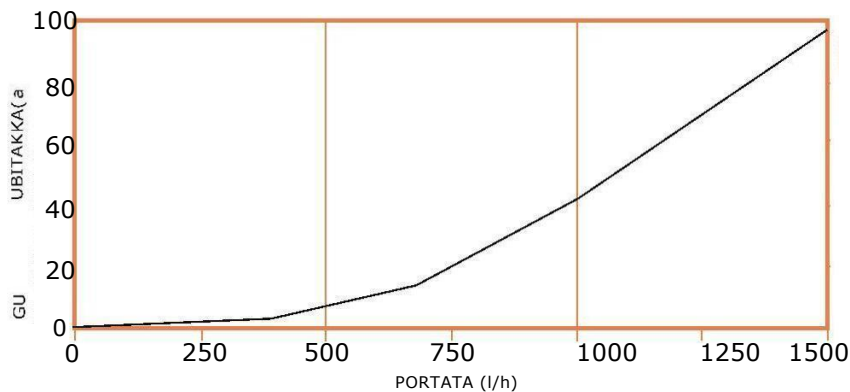

MEHANIČKA STABILNOST / MECHANICAL STABILITY

Temperatura vode / Water tempera- ture	20°C	40 °C	60°C
Max pritisak rada/Maxoperating pressure	8 bar	6 bar	4 bar
Pritisak pucanja/BurstPressure	25 bar	18 bar	14 bar

FITING ZA ECO – SPARK
FITTINGS ECO - SPARK

cod.1040361 cod.1040362 cod.1040363 cod.1040364 cod.1040365 cod.1040366 cod.1040367

Šifra/ code	OPIS description	Cena/ price
104036	Šelna ogrlica za fiksiranje panela Clamps for fixing assembly of the solar panels	10,80€
104036	Spojnica na lepljenje Ø 50 m crna	13,00€
104036	Čep ravni - crni Flat cap - black	4,30 €
104036	Odzračni ventil, navoj 3/4" Bleed valve, threaded 3/4"	47,50 €
104036	Gornja zakačaljka za krov Top roof mounting pad	8,60 €
104036	Donja zakačaljka za postavljanje na krov	13,80 €
104036	Automatska kontrola + ventil 3 položajni motor. 3 way motorized valve Ø50 (230 V)	1.620,00 €

TIPSKA KONFIGURACIJA – POVRŠINSKO DIMENZIONIRANJE JEDNAKO 60% POVRŠINE BAZENA
CONFIGURATION - SURFACE SIZING EQUAL TO 60% OF POOL SURFACE

Šifra/ code	dim. bazena	Br. Pane la	pale te	Protok preporučē n m3/h	šelna fiksaža	Donji prijlj. Za krov	Gornji prijlj.za krov	Prijlj. inc. Ø 50	Ravni čep	Odzrač ni venti	cena/ price
1040374	8,00x4,00	5	1	4,00	12	5	10	2	2	1	4.876,00 €
1040375	9,00x4,00	6	1	4,50	14	6	12	2	2	1	5.829,00 €
1040376	10,00x5,00	8	1	6,50	18	8	16	2	2	1	7.734,00 €
1040377	11,00x5,00	9	1	7,00	20	9	18	2	2	1	8.687,00 €
1040378	12,00x5,00	10	1	7,50	22	10	20	2	2	1	9.639,00 €
1040379	12,00x6,00	12	2	9,00	26	12	24	4	4	1	11.579,00 €

*montaža putem nosača nije predviđena

*mounting with socket connection with bracket not included

AMBIJENT BEZ VLAGE

Visoka vlažnost vazduha je glavni razlog stvaranja buđi, korozije, propadanje materijala i neprijatnih mirisa, faktori koji spuštaju kvalitet i vrednost proizvoda, materijala, opreme, civilnih i industrijskih objekata sa odgovarajućom opremom. Najbolje rešenje za kontrolu prekomerne vlage vazduha je ugradnja u takve ambijente odvlaživače ili uređaje za odvlaživanje koji ne remeteći termičke postojeće uslove, apsorbuju i eliminišu iz vazduha višak vlage. Odvlaživači mogu biti korišćeni za unutrašnje bazene (pokriveni) scenografski bazeni i lokali opremljeni za hidroterapeutsku upotrebu ili hidromasažne kade radi izbegavanja problema kondenzacije. Odvlaživači mogu se koristiti i u saunama, banjskim centrima, wellness centrima, sportskim aktivnostima uopšte. Odlične rezultate su postigle aplikacije unutar teleskopskih prekrivki od polikarbonata.

PRINCIP RADA

Odvlaživač je aparat koji omogućava održivost u prostoriji bazena idealne higrometrije od 60% do 70% tako garantujući dobar komfor korisnicima i dobro očuvanje strukture. Odvlaživač poseduje termodinamičko kolo (toplotna pumpa vazduh/voda) koje omogućava transformaciju toplog i vlažnog vazduha u topliji i suvlji vazduh (sl. 8). Njegov rad, sa sveukupnom reciklažom vazduha, omogućava veliku energetska uštedu od rešenja koje predviđa totalno uklanjanje vlažnog vazduha.

TIPOLOGIJA INSTALACIJE

Zavisno od modela, odvlaživači se instaliraju kako direktno u prostorijama za tretman, tako i u mašinskim prostorijama u blizini prostora bazena.

Postoje tri mogućnosti montaže:

- Ambijent: odvlaživač je postavljen u prostoriji bazena van korita bazena.
- Međuprostorni: Odvlaživač se postavlja u nekom međuprostoru u zidu.
- Kanalisani: odvlaživač se instalira u mašinsku prostoriju u blizini ambijenta bazena sa kojim je povezan jednom mrežom povratnih kanala za usis vlažnog vazduha i emisije toplog i suvog vazduha.

A HUMID-FREE ENVIRONMENT

The high humidity of air is the main cause of the formation of mold, corrosion, deterioration of materials and odors, factors that contribute to lower the quality and value of products, materials, equipment, civil and industrial premises with their furnishings. The most suitable solution to control excess air humidity is the insertion in the environments of dehumidifiers or dehumidification plants that, not altering the existing thermal conditions, absorb and eliminate excess humidity from the air. The dehumidifiers can be used for indoor swimming pools, scenic swimming pools and rooms used for hydrotherapy or whirlpool baths in order to avoid condensation problems. Dehumidifiers also find applications in saunas, spas, wellness centers, sports activities in general, gyms, indoor pools, rehabilitation pools, fitness centers and recreational pools. Excellent results have had internal applications to telescopic polycarbonate roofing.

PRINCIPLE OF OPERATION

The dehumidifier is a device that allows to maintain in the pool room an ideal hygrometry from 60% to 70%, in order to guarantee a good comfort to users and the good conservation of the structure.

The dehumidifier has a thermodynamic circuit (heat pump air/air), which allows to transform hot and humid air in warmer and drier air (Fig 8). Its operation, with the total recycling of air, allows a significant energy saving compared to the solution that provides for the total expulsion of damp air.

TYPE OF INSTALLATION

Depending on the model, the dehumidifiers are installed both directly in the room to be treated, and in a technical environment near the pool room.

There are three mounting options:

- Environment: the dehumidifier is located in the local pool far from the tank.
- Intermediate: the dehumidifier is placed in a intermediate local in the wall.
- Ducted: the dehumidifier is installed in a utility room nearby the swimming pool environment with which it is connected via a pipeline network of recovery for the intake of wet air and the inlet of hot and dry air.

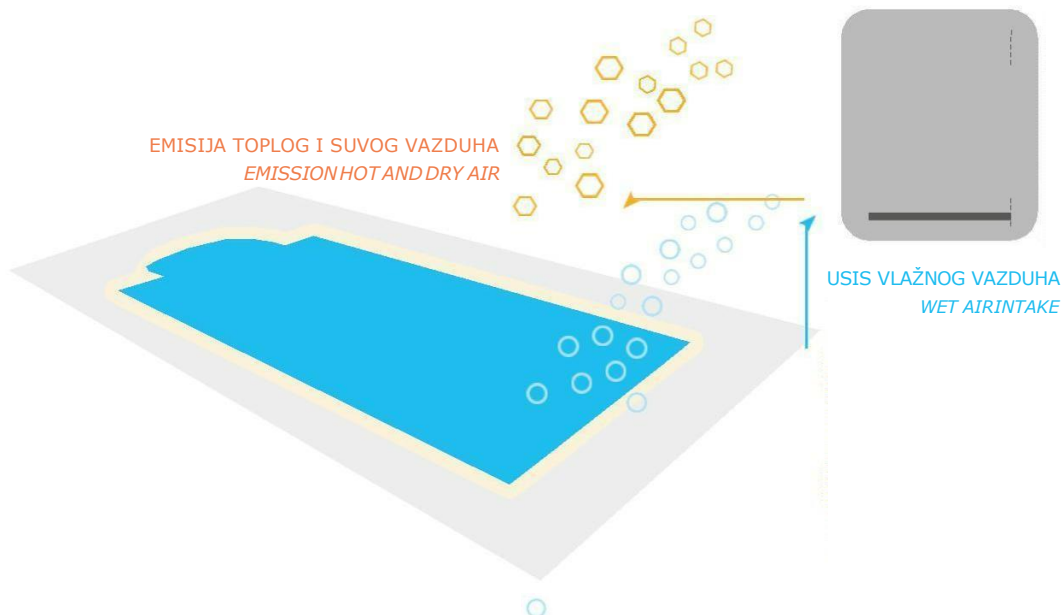
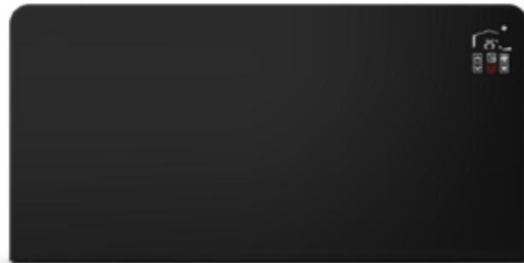

Fig 8: Funkcionisanje odvlaživača

**ODVLAŽIVAČI VAZDUHA
DEHUMIDIFIERS**

- Rashlađujući gas: R32
- Zidna instalacija
- Telo modernog dizajna
- Visoka estetika
- Tihi rad
- Refrigerant gas: R 32
- Wall installation
- Modern design shell
- Careful aesthetics
- Silent operation

Šifra/code	Opis/description	Cena/price
1041098	Odvlaživač WD 3.5 E da 3,00 l/h	5.440,00 €
1041099	Odvlaživač WD 4.5 E da 4,30 l/h	6.100,00 €



Model/ Model	WD 3.5 E	WD 4.5 E
Kapacitet odvlaživanja(l/24h*)/Dehumidificationcapacity(l/24h*)	72,00	103,00
Kapacitet odvlaživanja (l/h**) / Dehumidification capacity (l/h**)	3,00	4,30
Protok vazduha(m³/h)/Airflow(m³/h)	750	1030
Kapacitet električnog grejanja (kW) / Electric heating capacity(kW)	2,00	2,00
Potrošnja električne snage(kW)/Electricalpowerconsumption(kW)	1,13	1,97
Potrošnja električne snage (A) / Electrical power consumption (A)	5,0	8,8
Maksimalna potrošnja električne snage(kW)/Maximumabsorbedelectricpower(kW)	1,32	2,28
Maksimalni strujni rad (A) / Maximum Operating Current(A)	5,85	10,00
Napon struje (Volts/Frekuensi) / Power Supply (Volts/Frekuensi)	220-240V/50Hz	220-240V / 50 Hz
Relativna vlažnost (%RH) / Relative humidity(%RH)	Da 40~90	Da 40~90
Radna temperatura(°C)/Workingtemperature(°C)	Da 10°a 32°	Da 10° a 32°
Zvučna snaga da 1,00 m di distanza (dBA) / Acoustic power at 1.00m distance (dbA)	46	48
Dimenzije(LxPxH)(mm)/Dimensions(LxDXH)(mm)	1479x615x209	1690x647x207
Neto težina / Net weight	77	82
Bruto težina(kg)/grossweight(kg)	89	94
Prečnik cevi kondenzacije (mm) / Condensation pipe diameter(mm)	7,94	7,94

*Iskazani kapacitet za vazduh na 30°C e 80% relativne vlage./ *Data valid for a temperature of 30°C and a relative humidity of 80%

TRETMAN VODA WATER TREATMENT

KVALITET VODE BAZENA

Svaki dan se u vodu bazena unose mikroorganizmi, spore algi, kontaminirani elementi, bakterije, prašina, čađ i prljavština koji su štetni za zdravlje kupaca.

Čestice prašine i zamućenost, mikroorganizmi, kao što su alge, bakterije i virusi mogu se eliminirati dobrim filtracionim uređajem i efikasnim dizinfekcijskim tretmanom.

Prvi parametar o kome treba voditi računa je pH, koji otkriva stepen baznosti ili kiseline vode. Skala merenja ide od 0 do 14: ispod 7 imamo kiseli rastvor, iznad imamo bazni rastvor.

Kontrola pH je važna za jedan bazen pošto sa kiselim pH dolazi do korozije metala. Sa bazičnim pH dolazi do stvaranja naslaga, voda se muti, proizvodi na bazi hlora smanjuju deo njihovog kapaciteta dezinfekcije a koža i oči se mogu iritirati. Idealna vrednost za vodu bazena jeumerena bazična: ide od 7,2 do 7,6 cca. Drugi parametar je hlor: vrednost hlora merenog u bazenu mora biti između 0,5 i 1,2 mg/l.

pH i hlor mogu biti kontrolisani putem hemijskih proizvoda, tečnih, u tabletama ili prašku ili preko automatskih, regulacionih sistema, koji se baziraju na različite metode, kao što su elektroliza soli, ozonizacija, sterilizirajuće sijalice ili UV zraci.

THE QUALITY OF POOL WATER

Every day microorganisms, algae spores, contaminants, bacteria, dust, soot and dirt are introduced into the pool water, which are harmful to bathers' health.

The particles of dirt and the turbidity, microorganisms such as algae, bacteria and viruses can be eliminated by a good filtration system and an effective disinfectant treatment (Fig. 1).

The first parameter to be considered is the pH, which reveals the degree of alkalinity or acidity of the water. The measuring scale goes from 0 to 14; an acidic solution is below 7, a basic solution is above 7.

The pH control is important for a swimming pool because with acidic pH there is corrosion of metals, excessive use of disinfectants and irritation of skin and eyes. With basic pH you have the formation of encrustations, water tends to become cloudy, chlorine products decrease part of their disinfectant capacity, and skin and eyes can become irritated. The ideal value for pool water is slightly basic: ranging from about 7.2 to 7.6.

The second parameter is chlorine: the value of chlorine measured in the pool must be between 0,5 and 1,2 mg/l.

The pH and the chlorine can be managed through liquid chemical products, in tablets or powder or through automatic adjustment systems, based on different methodologies, such as electrolysis of salt, ozonation, UV lamps sterilizers.

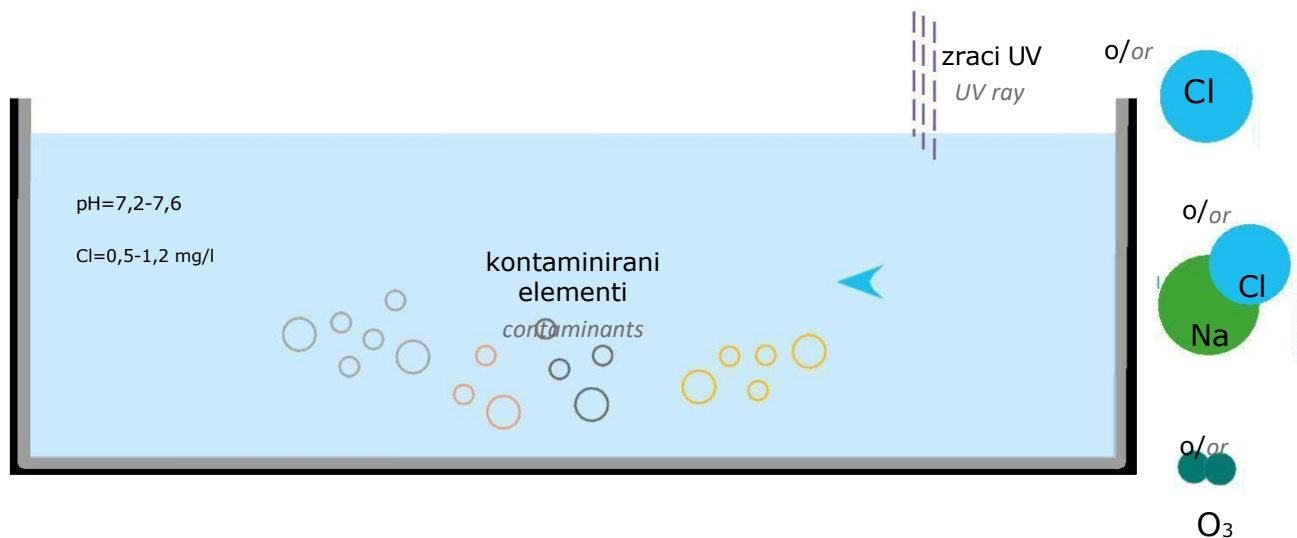

Fig1:Dezinfekcija vode
Fig 1: Water disinfection

EKOODRŽIVA DEZINFEKCIJA

Elektroliza je sistem dizinfekcije na bazi hlora: do dezinfekcije dolazi zahvaljujući proizvodnji hlora koja se dobij preko procedure razbijanja molekula natrijum hlorida (so) u hlora gas (Cl_2) i kaustičnu sodu (NaOH). U ovom slučaju bazen će biti dezinfekvan putem hlora gasa ; Oni se mogu međusobno prekomponovati i formirati natrijum hipohlorit (NaClO): u ovom slučaju bazen će dezinfekovati hipohlorit.

Ovi procesi ne generišu nikakve zagađujuće ostatke i nisu im potrebni hemijski proizvodi. So se inače, automatski rekonponuje zahvaljujući efektima UV zraka da bi se ponovo iskoristio. Iz ovih razloga se radi o ekoodrživom sistemu.

Princip funkcionisanja aparata je jednostavan : razbija se molekula natrijum hlorida prolaskom (slane vode) kroz magnetno polje (anoda i katoda), formirajući gore opisana jedinjenja . (Sl. 2). Količina potrebne soli je obuhvaćena između 3 i 6 grama / liter.

PREDNOSTI

Prednosti su: manja koncentracija hlora u vodi; automatska i stalna dezinfekcija; dobar komfort za kupaće; eliminacija problema akumulacije izocijanurane kiseline; eliminacija rizika predoziranja sredstva za dezinfekciju.

A SUSTAINABLE DISINFECTION

Electrolysis is a chlorine-based disinfecting system:

the disinfection is due to the production of chlorine, that is obtained through a process of cleavage of the molecule of sodium chloride (salt) obtaining chlorine gas (Cl_2) and sodium hydroxide (NaOH). In this case, the pool will be disinfected using chlorine gas, or they may recombine with each other and form sodium hypochlorite (NaClO): in this case the pool will be disinfected by hypochlorite.

These processes do not generate any polluting residue and do not require any chemicals. Also the salt is recomposed automatically thanks to the effect of UV rays and it is reused. For these reasons it is an environment-friendly system.

The operating principle of the apparatus is simple: the sodium chloride molecule is cleaved through the passage (of salt water) inside a magnetic field (anode and cathode), producing the compounds described above. (Fig. 2). The amount of salt required is normally comprised between 3 and 6 grams / liter.

BENEFITS

The advantages are: lower concentration of chlorine in water; automatic and continuous disinfection; good comfort for bathers; elimination of the problem of the accumulation of isocyanuric acid; elimination of the risk of excessive dosing of disinfectant.

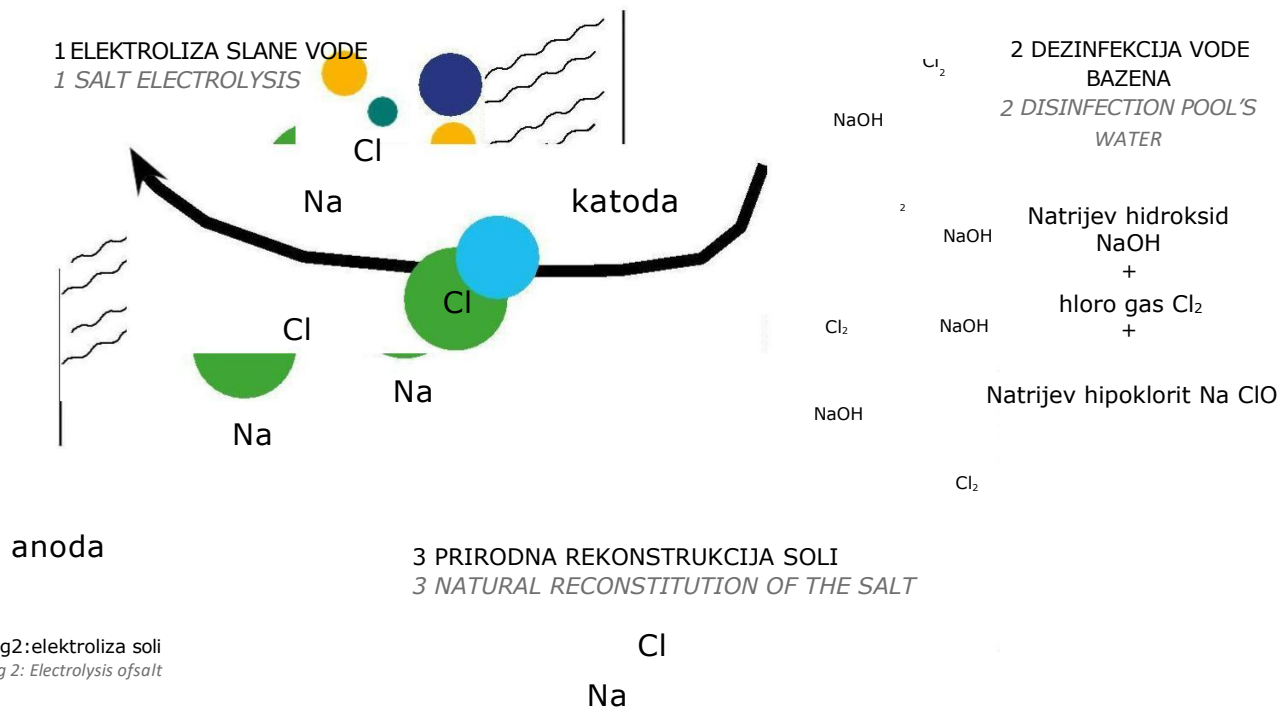

Fig2: elektroliza soli
Fig 2: Electrolysis of salt

AUTOCHLOR RP



- Sistem visokog učinka
- Visok stepen proizvodnje hlora za svaku jedinicu
- Proces uklanjanja kamenca protiv stvaranja kalcijuma
- Lako instaliranje
- Male dimenzije i mala težina aparata
- Lako održavanje i čišćenje ćelije

- *High-performance system*
- *High rate of production of chlorine for each unit*
- *Descaling action against the formation of calcium*
- *Simple installation*
- *Small size and lightness of the device*
- *Easy maintenance and cleaning of the cell*

Šifra/code	Opis/description	Cena/price
1075040	Autochlor RP 15	1.192,30 €
1075031	Autochlor RP 20	1.516,00 €
1075041	Autochlor RP 25	1.624,60 €
1075032	Autochlor RP 36	2.223,20 €
1075022	Autochlor RP 50 HD	4.061,60 €
1075023	Autochlor RP 64 HD	4.498,90 €
1075042	Autochlor RP 100 HD	7.113,40 €

Šifra	Opis	clorogas g/h equivalent	Zapremina bazena*
1075040	Autochlor RP 15 / Autochlor RP 15	15	75 m ³
1075031	Autochlor RP 20 / Autochlor RP 20	20	90 m ³
1075041	Autochlor RP 25 / Autochlor RP 25	25	120 m ³
1075032	Autochlor RP 36 / Autochlor RP 36	36	170 m ³
1075022	Autochlor RP50 HD	50	230 m ³
1075023	Autochlor RP 64 -RP64HD	64	300 m ³
1075042	Autochlor RP 100 HD / Autochlor RP 100 HD	100	450 m ³

*Zapremina max. preporučena sa vremenom recikliranja 12 h/dn. i kućno korišćenje bazena

Volume max. recommended with a recirculation time of 12 h/day and domestic use of the pool

AUTOCHLOR RP-PH



Dozir pumpa
cod.1075170

- Automatski sistem tretmana kompletan i efikasan
- Povetuje elektrolizu slane vode sa regulisanjem pH
- U sastavu: 1 AUTOCHLOR-RP, 1 peristaltička dozirna pumpa HPR1 simkompletna sa elektrodom, nosač elektrode, puferi rastvori, 2 utičnice za nosače
- So u tabletama je jedna mešavina soli visoke hemijske čistoće (sadržaj NaCl veći od 99,9%) i hlora u minimalnoj količini

- *complete and effective processing system*
- *it associates the electrolysis of salt water with a pH adjustment*
- *complete of: 1 AUTOCHLOR-RP, 1 pump adjusting pH PR1 simcomplete model of electrode, electrode holder, buffer solutions, 2 sockets bracket*
- *the salt tablets is a mixture of salt of high chemical purity (content of NaCl greater than 99.9%) and chloride in small amounts*

Šifra/code	Opis/description	Cena/price
1075044	Autochlor RP-PH 15 / Autochlor RP-PH 15	1.538,00 €
1075090	Autochlor RP-PH 20 / Autochlor RP-PH 20	1.862,00 €
1075045	Autochlor RP-PH 25 / Autochlor RP-PH 25	1.971,00 €
1075091	Autochlor RP-PH 36 / Autochlor RP-PH 36	2.569,00 €
1075114	Autochlor RP-PH 50 HD / Autochlor RP-PH 50 HD	4.773,00 €
1075115	Autochlor RP-PH 64 HD / Autochlor RP-PH 64 HD	5.210,00 €
1075116	Autochlor RP-PH 100 HD / Autochlor RP-PH 100 HD	7.825,00 €

OPREMA I ZAMENE AUTOCHLOR RP E RP-PH
AUTOCHLOR RP AND RP-PH ACCESSORIES AND SPARE PARTS

Šifra/code	Opis/description	Cena/price
ZAMENA KOMPLETNIH ČELIJA AUTOCHLOR		
600-00979	Kompletna ćelija Autochlor RP 15 / Complete cell Autochlor RP 15	593,00 €
600-00917	Kompletna ćelija Autochlor RP 20 / Complete cell Autochlor RP 20	690,00 €
600-00978	Kompletna ćelija Autochlor RP 25 / Complete cell Autochlor RP 25	769,00 €
600-00918	Kompletna ćelija Autochlor RP 36 (fino al 2016) / Complete cell Autochlor RP 36 (until 2016)	1.008,00 €
600-00923	Kompletna ćelija Autochlor RP 36 (apartire dal 2016) / Complete cell Autochlor RP 36 (from to 2016)	1.008,00 €
600-00925	Kompletna ćelija Autochlor RP 50 HD / Complete cell Autochlor RP 50 HD	3.166,00 €
600-00926	Kompletna ćelija Autochlor RP 64 HD / Complete cell Autochlor RP 64 HD	3.573,00 €
600-00924	Kompletna ćelija Autochlor RP 100 HD / Complete cell Autochlor RP 100 HD	4.333,00 €



cod. 600-00979

Cena/code	Opis/description	Cena/price
SPECIJALNA SO ZA ELEKTROLIZU		
1075018	Specijalna so u tabletama – vreća od 25 kg / Special salt tablets - 25 kg bag	21,40 €
1075019	Specijalna so u granulama – vreća od 25 kg / Special salt granular - 25 kg bag	20,30 €
1055234	Trousse sale / 10 strips	27,60 €



cod.1075018



cod.1075019

Šifra/code	Opis/description	Cena/price
OPREMA		
5000000	Magnezijum anoda 50 mm / Magnesium anode 50 mm	32,00€
5000001	Magnezijum anoda 110 mm / Magnesium anode 110 mm	35,30€
HLORNI STABILIZATOR		
9010035	Izocijanurna kiselina / Isocyanuric acid	24,20€



cod.5000000



cod.9010035



- Elektrolitski generator sa unapređenom elektronskom kontrolom
Sa stalnim praćenjem električne efikasnosti sistema generator-ćelija
- Optimizacija električne potrošnje i trajanja ćelije u funkciji realnih uslova vode u bazenu.
- Samočišćeća ćelija sa inverznim polom sa programiranim tajmerom radi maksimiziranja korisnog života ćelije
- Display pojednostavljen radi programiranja parametara upravljanja
- Kontakt graničnika hoda roletne
- Visok procenat proizvodnje hlora za svaku jedinicu
- Radnja skidanja naslaga protiv stvaranja kalcijuma putem inverzije pola
- Nova ćelija na liniji niskog gubitka pritiska
- *Electrolytic generator with advanced electronic control with constant monitoring of the electrical efficiency of the generator-cell system*
- *Optimization of electrical consumption and cell life according to the actual water conditions in the tank*
- *Reverse polarity self-cleaning cell with programmed timing to maximize cell life*
- *Facilitated menu for programming management parameters*
- *Roller shutter limit contact*
- *High rate of chlorine production per unit*
- *Descaling action against calcium formation by reversing polarity*
- *New in-line cell with low pressure drop*

Šifra/code	Opis/description	Cena/price
1040007	Uniko 50	1.380,00 €
1040008	Uniko 75	1.576,00 €
1040009	Uniko 100	1.692,00 €
1040010	Uniko 150	2.004,00 €

Šifra	Opis	hlorogas g/h equivalent	Zapremina bazena*
1040007	Uniko 50	10	50 m ³
1040008	Uniko 75	15	75 m ³
1040009	Uniko 100	20	80 m ³
1040010	Uniko 150	30	150 m ³

*Zapremina max. preporučena sa vremenom recirkulacije jednakim 12 h/dan i privatno korišćenje bazena

*Volume max. recommended with a recirculation time of 12 h/day and domestic use of the pool

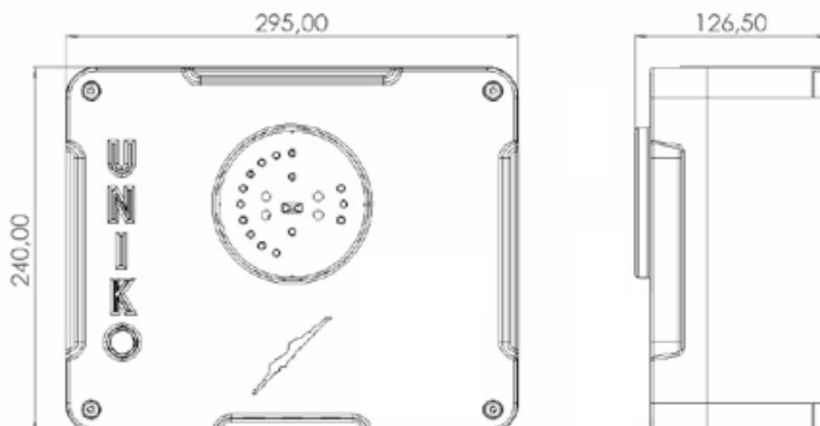



- Elektrolitski generator sa unapređenom elektronskom kontrolom Sa stalnim praćenjem električne efikasnosti sistema generatora-ćelije
- Optimizacija elektronske potrošnje i trajanja ćelije u funkciji realnih uslova vode u bazenu
- Sistem namenjen elektrolitskom generisanju i pH regulisanju Samočišćaća ćelija sa inverznim polaritetom sa programiranim tajmerom radi maksimiziranja korisnog života ćelije
- Display pojednostavljen radi programiranja parametara upravljanja
- Kontakt graničnika hoda roletne
- Visok procenat proizvodnje hlora za svaku jedinicu
- Radnja skidanja naslaga protiv stvaranja kalcijuma putem inverzije polariteta
- Nova ćelija na liniji malog gubitka pritiska
- *Electrolytic generator with advanced electronic control with constant monitoring of the electrical efficiency of the generator-cell system*
- *Optimization of electrical consumption and cell life according to the actual water conditions in the tank*
- *Dedicated system for electrolytic generation and pH adjustment*
- *Reverse polarity self-cleaning cell with programmed timing to maximize cell life*
- *Facilitated menu for programming management parameters*
- *Roller shutter limit contact*
- *High rate of chlorine production per unit*
- *Descaling action against calcium formation by reversing polarity*
- *New in-line cell with low pressure drop*

Sifra/code	Opis/description	Cena/price
1075241	Uniko PRO 50	1.812,00 €
1075242	Uniko PRO 75	1.964,00 €
1075243	Uniko PRO 100	2.124,00 €
1075244	Uniko PRO 150	2.436,00 €

Sifra	Opis	horogas g/h equivalent	Zapremina bazena*
1075241	Uniko PRO 50	10+dosaggio pH	50 m³
1075242	Uniko PRO 75	15+dosaggio pH	75 m³
1075243	Uniko PRO 100	20+dosaggio pH	90 m³
1075244	Uniko PRO 150	30+dosaggio pH	150 m³

*Zapremina max. preporučena sa vremenom recirkulacije jednakim 12 h/dan i privatno korišćenje bazena

*Volume max. recommended with a recirculation time of 12 h/day and domestic use of the pool

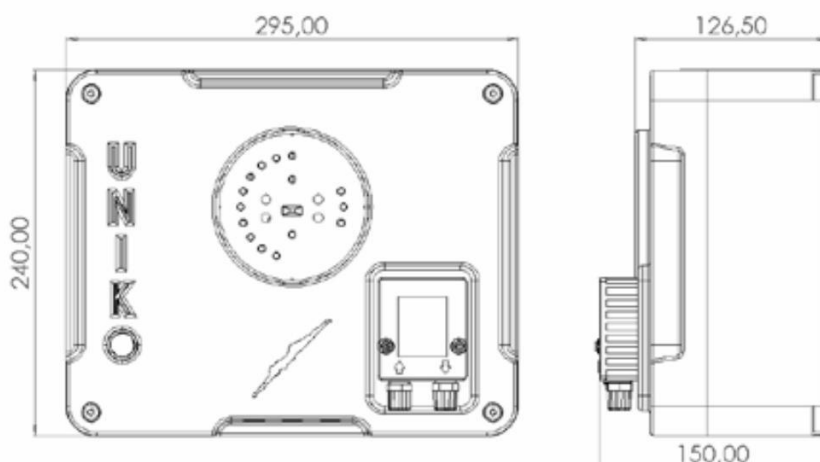

UNIKO Mg

MADE IN ITALY



Uniko Mg je inovativni sistem tretmana vode, baziran na jednoj mešavini soli magnezijuma koji doprinose blagodeti kože.

Uniko Mg je srce sistema tretmana koje čisti vodu garantujući kristalno čistu kvalitet. Novi model funkcioniše sa samo jednom ćelijom visoke efikasnosti generisanja. Glavna komponenta ove ćelije jeste elektroda velikog potencijala koja garantuje visoku performance generatora, koji sa svoje strane omogućava jednostavno i svrsishodno korišćenje bazena, povezujući zabavu i održavanje zdravlja.

Uniko Mg is an innovative water treatment system, based on a mixture of magnesium salts which bring benefits to the skin.

Uniko Mg is the heart of the treatment system that purifies water, it ensures a crystal clear quality. The new model works with a single high efficiency generation cell. The key component of this cell is the electrode of high capacity that ensures the high performance of the generator, in turn it enables an easy and safe use of the pool, linking entertainment and health care.



Karakteristike performansi generatora Uniko Mg	
Napajanje	240 V / 50-60 Hz
Zapremina bazena	fino a 75* m ³
Automatsko čišćenje ćelija	Programmabile 6-12 ore
Zaštita protiv hoda na suvo	Rilevamento automatico del flusso
Protok uređaja za cirkulaciju	9-27 m ³ /h
Proizvodnja hlora	20*g/h
Grado IP	24
Nivo koncentracije soli preporučnog TDS	2500-3500 ppm

*Merenje urađeno na 26° C, salinitet 3000ppm i tok od 12 m³/h



Optimalni uslovi učinka vode bazena	
TDS – Koncentracija soli	3000 ppm
Alkalnost ukupna	90-150 ppm
Cijanidna kiselina	40-65 ppm
pH	7.2-7.4
Tvrdoća vode	< 28 °f

Šifra/code	Opis/description	Cena/price
1040012	Uniko Mg	2.305,00 €



Šifra/code	Opis/description Oprema / Accessories	Cena/price
5000000	Magnezijum anoda 50 mm Magnesium Anode 50 mm	33,60 €
1075017	BiancoPuro - soli al magnezijuma džak 25 kg BiancoPuro - magnesium salt bag 25 kg	86,00 €
1075020	BiancoPuro - sale al magnesio secchio 25 kg BiancoPuro - magnesium salt bucket 25 kg	97,20 €
1080226	BiancoPuro - vetro finissimo cristallino 25 kg BiancoPuro - very fine crystal glass 25 kg	23,20 €

Zahvaljujući mešavini soli BiancoPuro™, usporava na prirodan način širenje bakterija. Istraživanja su dokazala da sa sistemom Uniko Mg generiše se il 40% manje hloramina, koje rastu mnogo sporije upoređujući sa tretmanom elektrolize soli. Sa sistemom BiancoPuro™ biraš vodeni ambijent blagodeti za celu fam il i ju poštujući ambijent.

Thanks to the BiancoPuro™ salt mixture, it naturally slows down the proliferation of bacteria. Research has shown that with the Uniko Mg system, 40% less chloramines are generated, which grow much more slowly than with salt electrolysis treatment. With the BiancoPuro™ system, you choose an environmentally friendly wellness aquatic environment for the whole family.

VODA ČISTIJA ZA 60%

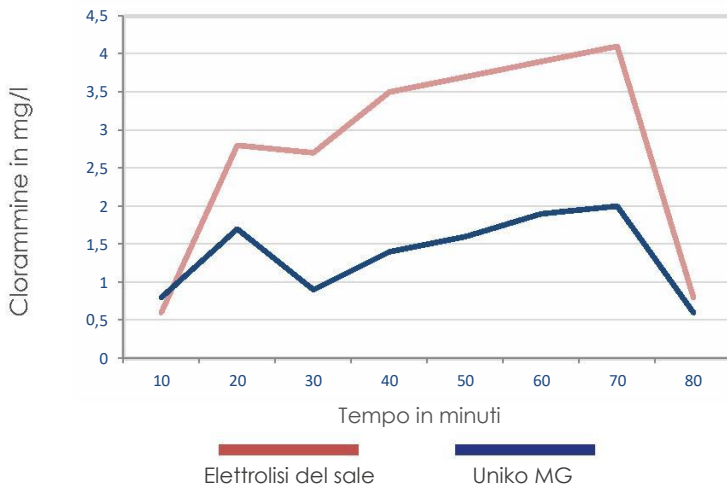

Uniko Mg è je jednostavna i automatski sistem, eliminiše Tradicionalne ograničavajuće tretmane sa hemijskim sanacijama i garantuje izvanrednu providnost vode zahvaljujući kombinovanoj akciji dva faktora:

1. Prirodna moć razbistravanja Magnezijuma
2. Odlična filtracija zagarantovana granulama VetroPuro™

Uniko Mg is an easy and automatic system, it eliminates the constraints of traditional treatment with sanitizing chemicals and provides exceptional water clarity due to the combination of two factors:

1. The natural power of fining Magnesium
2. The excellent filtering guaranteed by crystals VetroPuro™

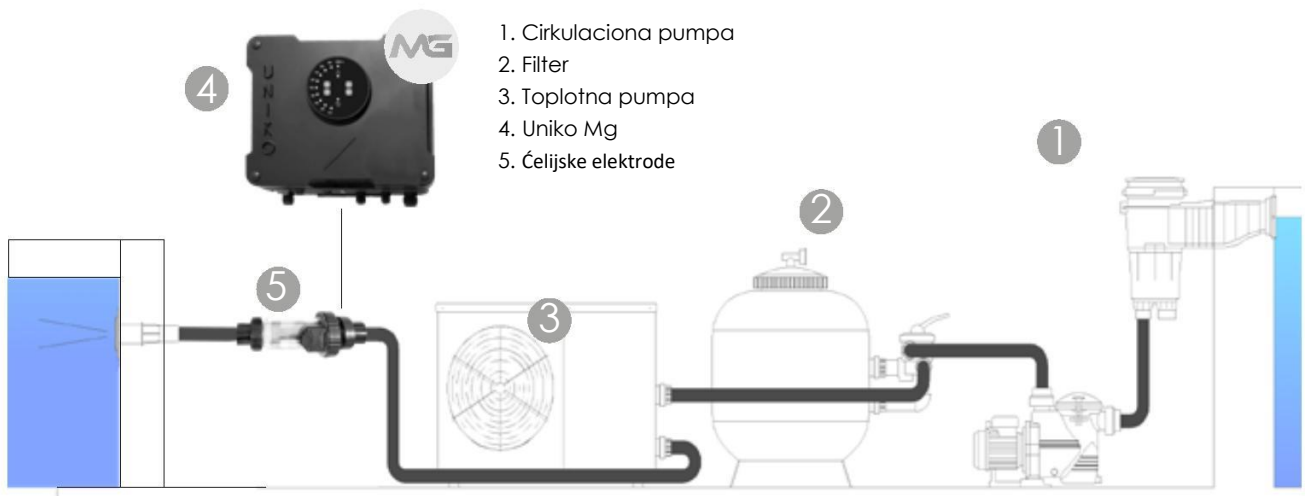

DŽAKOVI SOLI ZA ELEKTROLIZU BAGS OF SALT FOR ELECTROLYSIS

Rafinisana so, rekristalisana ključala, visoke solventnosti (100%) bez ostataka i stranih minerala, idealan za uređaje sa elektrolizom (u granulama) i omešivačima (u tabletama). Izričito se preporučuje za Premio+ i Autochlor.

Refined salt, recrystallized from boiling, high solubility (100%) free of debris and foreign minerals, ideal for electrolysis plants and water softeners. Specifically recommended for Premio+ and Autochlor.

Šifra/ code	Opis/description	Cena/ price
1075018	Specijalna so u tabletama – džak od 25 kg / Special salt tablets - 25 kg bag	19,80 €
1075019	Specijalna granularna so – džak od 25 kg / Special salt granular - 25 kg bag	18,40 €



cod.1075018



cod.1075019

LAMPE NA ZRAKE UV-C EASY UV UV-C RAY LAMPS

NEW

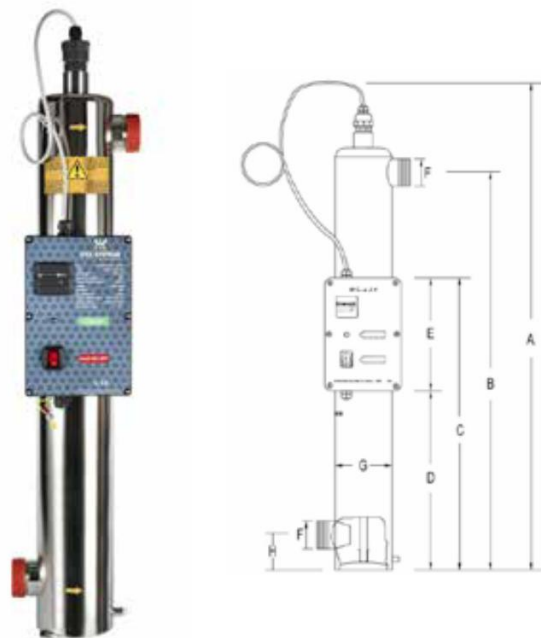

Aparati EASY-UV, bakteriološki ispitani dezinfikuju vodu bazena putem svetla UV-C i uništavaju hloroamine.

- Garantuju svežu vodu, čistu i providnu
- Od prvog dana rada može se dobiti stepen dezinfekcije između 75% e il 91%, posle drugog dana već 94%
- Štite bazen od propadanja materijala
- Izbegavaju formiranje bakterija, virusa, algi, pečurki, parasita i drugih mikroorganizama
- Omogućavajući smanjenje upotrebe hlora i ostalih hemijskih proizvoda
- Predupređuju miris hlora i iritaciju kože i očiju
- Lako se integrišu u kolo pumpe za filtraciju.

EASY-UV, bacteriologically tested devices disinfect pool water by UV-C light and destroy chloramines.

- They ensure fresh, clean and clear water
- From the first day of operation, a disinfection degree between 75% and 91% can be achieved, after the second day already 94%
- They protect the tank from deterioration of materials
- They prevent the formation of bacteria, viruses, algae, fungi, parasites and other microorganisms
- They make it possible to reduce the use of chlorine and other chemicals
- They prevent chlorine odor and skin and eye irritation
- Easily integrated into the filtration pump circuit

Model	A [mm]	B [mm]	C [mm]	D [mm]	E [mm]	F [mm]	G [mm]	H [mm]
1075210	1000	805	650	400	240	2" male	125	80

Šifra/code	Opis/description	cena/price
1075210	Sterilizzatore EASY UV	2.061,00 €
Rezervni delovi/ REPLACEMENT		
1075212	Lampa 80W za sterilizzatore EASY-UV	257,00 €

karakteristike / Features	
Lampa / Lamp	1x lampa niskog pritiska/ 1x low pressure lamp
Max trajanje lampe / Max. service life of lamp	9000 h
Potrošnja energije / Power consumption	80 W
Talasna dužina / Wave length	253,7 nm
Vreme ekspozicije / Dwell time	6,7 - 2,25 sec.
Voltaža / Voltage	230 V
Frekvencija / Frequency	50 Hz
Stepen zaštite / Degree of protection	IP 54
Balast	Elektronico / Electronic
Protok / Flow rate	5 - 15 m ³ /h
Max protok / Max flow rate	30 m ³ /h / 30 m ³ /h
Max pritisak / Max. Pressure	2,5 bar
Korpus / Vessel	AISI 316 / 1.4404 elettrolucidato/ electropolished
Interval radne temperature / Working temperature range	10 - 40 °C
Brojač sati / Hour counter	Si
Prekidač on-off / On-off switch	Si

LAMPA ZRACI UV-C 4 ALL
UV-C RAY LAMP 4 ALL



Cod. 1075207 -1075208



Cod. 1075209



Lampe na UV-C zrake otporne su, podržive i jednostavno za ugradnju. L'UV-C 4ALL sadrži ležište Duplex sa velikom otpornošću na korozijutako da odgovara i bazenima sa sistemima za elektrolizu soli.

- Garantuju svežu vodu, čistu i providnu
- Dezinfektiju vodu na siguran e i efikasan način
- Štite bazen od vrsta patogenih organizama
- Kontrolišu stvaranje buđi, bakterija algi
- Omogućavaju umanjeње od 80% l'upotrebu hlora i drugih hemijskih supstanci
- Predupređuje miris hlora i iritaciju kože i očiju
- U modelima inox funkcija timer sa računanjem trajanja veka lampe

Pored prednosti da se poseduje jedna jedina jedinica koja odgovara svim vrstama vode bazena, lampe odgovaraju rastućem zahtevu otpornijih i podrživih materijala: eliminisani su plastični reaktori menjajući ih sa čelikom koji ima veću trajnost i otpornost.

UV-C lamps are durable, sustainable, and easy to install. The UV-C 4ALL contains a Duplex housing with high corrosion resistance, making it suitable even for pools with salt electrolysis systems.

- It ensure fresh, clean and clear water
- It disinfect the water safely and efficiently
- It protect the pool from strains of pathogenic organisms
- It control the formation of mold, bacteria and algae
- It allow the use of chlorine and other chemicals to be reduced by 80%
- Prevents chlorine odor and skin and eye irritation
- In stainless steel models, timer function with counting of lamp life hours

In addition to the convenience of having one unit suitable for all types of pool water, the lamps meet the growing demand for more durable and sustainable materials: plastic ballasts have been eliminated and replaced with steel, which has greater durability and strength.

Šifra/code	Opis/description	Cena/price
MODELI SA TIMER		
1075207	Sterilizator UV-C 4ALL 75 W sa timerom UV-C 4ALL 75 W sterilizer with timer	1.148,00 €
1075208	Sterilizator UV-C 4ALL 130 W sa timer 4ALL 130 W UV-C sterilizer with timer	1.983,50 €
MODELI BEZ TIMER		
1075209	Sterilizator UV-C 4ALL 40 W UV-C Sterilizer 4ALL 40 W	874,60 €
REZ.DELOVI/ REPLACEMENT		
1075211	Lampa 40 W per sterilizator UVC Replacement lamp 40 W for UVC sterilizer	95,20 €
1075098	Lampa 75 W per sterilizator UVC Replacement lamp 75 W for UVC sterilizer	98,00 €
1075095	Lampa 130 W ZA sterilizator UVC Replacement lamp 130 W for UVC sterilizer	573,90 €

Karakteristike/ Features	cod.1075207	cod.1075208	cod.1075209
Telo lampe / Housing	inox 316	inox 316	inox 316
Kapacitet bazena / Capacity of the pool	75.000 l	150.000 l	40.000 l
Lampa / Lamp	75 watt	130 watt	40 watt
Maksimalni pritisak / Maximum pressure	2 bar	2 bar	2,5 bar
Dužina aparata / Length unit	100 cm	100 cm	100 cm
Isijavanje / Irradiation	30 mJ/cm ²	30 mJ/cm ²	30 mJ/cm ²
Maksimalni protok / maximum flow rate	23 m ³ /h	23 m ³ /h	23 m ³ /h
Preporučeni protok / Recommended flow rate	16 m ³ /h	22 m ³ /h	11 m ³ /h
Prečnik ulaz / izlaz / Diameter of inlet / outlet	63-50 mm	63-50 mm	63-50 mm
Merač protoka / Flowmeter	-	da	-
Timer / Timer	da	da	-

**SIJALICA UV SREDNJE-NIZAK PRITISAK
MEDIUM-LOW PRESSURE UV LAMP**



- Kompletan asortiman za javne bazene
- Sistemi da 0,3 a 1200 m3/h
- Čelični kolektori AISI304 (na upit AISI 316 L/ HDPE)
- Lampe sa živinom parom niskog i srednjeg pritiska i amalgamske
- Kontrolne mikropcesorne centrale
- Complete range for public pools
- Systems from 0.3 to 1200 m3/h
- Manifolds in stainless steel AISI 304 (on request AISI 316 L/ HDPE)
- Mercury vapor lamp at low and medium pressure and amalgam
- Microprocessor control

KARAKTERISTIKE MOD. NISKOG PRITISKA

- Stepen zaštite IP55
- Temperatura ambijenta od 2° do 40°
- Električno napajanje 230V , 50 Hz
- Ukupan brojčanik
- Brojač koji se može resetovati sa upozorenjem isteka radnog veka sijalice
- Led crvena za anomalije
- Relè alarm čist kontakt NA/NC
- Relè alarm izlaza 230 V , NA/NC, 2A MAX
- Display kontrola radijacija/temperatura
- Gašenje zbog visoke temperature kolektora

FEATURES MOD. LOW PRESSURE

- Degree of protection IP55
- Temperature from 2° to 40°
- Power supply 230V, 50 Hz
- Total counter
- Counter reset with warning of the end of life of lamp
- Red LED for fault
- Alarm relay dry contact NA/NC
- Alarm relay output 230 V, NA/NC, 2A MAX
- Display control radiation / temperature
- Shutdown due to high temperature collector

KARAKTERISTIKE MOD. SREDNJEG PRITISKA

- Stepen zaštite IP55
- Temperatura ambijenta od 2° do 40°
- Električno napajanje 380/400V
- Magnetnotermički prekidač
- Brojač koji se može resetovati sa upozorenjem isteka radnog veka sijalice
- Kontrola temperature unutar kutije
- Kontrola ispravnog rada sijalica
- Vidljivi alarm za anomalije
- Relè alarm čistog kontakta NA/NC
- Relè alarm izlaza 230 V, NA/NC, 2A MAX
- Kontrola temperature i radijacija sa pragovima alarma
- Gašenje zbog visoke temperature kolektora

FEATURES MOD. MEDIUM PRESSURE

- Degree of protection IP55
- Temperature from 2° to 40°
- Power supply 380/400 V
- Switch magnetic
- Counter reset with warning of end of life lamp
- Control temperature inside the switchboard
- Control of good function of lamps
- Visual alarm fault
- Alarm relay dry contact Na / NC
- Alarm relay output 230 V, NA / NC, 2A MAX
- Temperature monitoring and irradiation with alarm thresholds
- Shutdown under high temperature collector

**CENE NA UPIT
PRICES ON REQUEST**

MODEL	SIJALICA	Maksimalni pritisak	UVC regulisanje	protok max	preč.	komora	Kompatibilni filteri*
UV-S-307 niski pritisak	3X80W	9 bar	400 J/m2	20 m3/h	2" M	aisi 304	750-900
UV-S-305 niski pritisak	4X80W	9 bar	400 J/m2	30 m3/h	DN 80	aisi 304	1000
UV-S-306 niski pritisak	5X80W	9 bar	400 J/m2	40 m3/h	DN 80	aisi 304	1200
UV-S-703 b.p. amalgama	2X200W	9 bar	400 J/m2	60 m3/h	DN 80	aisi 304	1400-1600
UV-S-704 b.p. amalgama	3X200W	9 bar	400 J/m2	96 m3/h	DN 100	aisi 316L	1600-1800
UV-S-705 b.p. amalgama	4X200W	9 bar	400 J/m2	125 m3/h	DN 150	aisi 316L	2000-2200
UV-S-600 Esrednji pritisak	1X600W	9 bar	600 J/m2	33 m3/h	2" 1/2	aisi 316L	750-900-1000
UV-S-601 Esrednji pritisak	1X1000W	9 bar	600 J/m2	55 m3/h	DN 100	aisi 316L	1250-1400
UV-S-602 Esrednji pritisak	1X2000W	9 bar	600 J/m2	120 m3/h	DN 150	aisi 316L	1800-2000-2200
UV-S-603 Esrednji pritisak	1X2500W	9 bar	600 J/m2	170 m3/h	DN 200	aisi 316L	2000-2200

*Indikativne vrednosti podložne logikama uređaja

Public pools

JAVNI

BAZENI



6

SADRŽAJ

REFERENCE STANDARDA / NORMATIVE REFERENCE

292 ŠEMA TIPSKOG UREĐAJA / TYPE PLANT SCHEME

FILTERI / FILTERS

300 VERDUNO
301 BLU HBS
302 TANARO
303 DANUBIO
304 POLARIS SIDE
305 EUROPA NAMOTANO
306 ATLANTICO STANDARDI UNI
307 POVRATNE BATERIJE / BACKWASH BATTERIES
308 GRUPA URANO 1-2-3 / URANUS GROUP 1-2-3

PUMPE / PUMPS

309 SERIE AURORA SA I BEZ PREFILTERA / AURORA SERIES WITH OR WITHOUT PREFILTER
311 SERIE RIVER
312 SERIE GHISA NM / CAST IRON NM PUMPS
313 SERIE GHISA NM4 / CAST IRON NM4 PUMPS

PREFILTERI / PREFILTERS

314 PREFILTERI GRUBE OBRADE OD POLIPROPILENA E POLIFENILENOS
KSIDA /
315 PREFILTERI GRUBE OBRADE OD ČELIKA INOX / STAINLESS STEEL ROUGHER PREFILTERS

KOMANDNE TABLE POOL CONTROL / ELETRIC PANEL POOL CONTROL

ZIDNA GALANTERIJA / WALL ACCESSORIES

316 SLIVNICI PODA VISOKOG PROTOKA / BIG RANGE MAIN DRAIN
316 ZIDNA REŠETKA I SET PODLOŠKI REŠETKE/WALL GRILL AND GRID SUPPORT KIT

INSTRUMENTI / TOOLS

317 MANOMETRI I SLAVINE / MANOMETER AND FAUCET
317 MERAČI PROTOKA PITOT/ PITOT FLOWMETERS

OPREMA / ACCESSORIES

318 TUNNEL TUŠ, PLOČE ZA OKRET I REŠETKE /TUNNEL SHOWER, TURNING PLATE AND
GRIDS
319 PLUTAJUĆE TRAKE I INDIKATORI TAKMIČENJA/ LANES AND NOTICE INDICATORS
320 KOLICA ZA NAMOTAVANJE TRAKA/ CART FOR LANES
321 STARTNI BLOKOVI / STARTING BLOCKS
322 VISOKE STOLICE ZA NADGLEDANJE / SURVEILLANCE HIGH
CHAIR

FIZIOTERPEUTSKI BAZENI / PHYSIOTHERAPY POOLS

324 ELEKTRIČNI DIZAČ PACIJENATA / ELECTRIC LIFTING PATIENTS
325 SPORA REKA / SLOW RIVER

KLASIFIKACIJA BAZENA

Kompatibilno standardima UNI 10637:2024 bazeni javne upotrebe se klasifikuju kako sledi:

TIP 1: javni bazeni, kao na primer opštinski bazeni, bazeni za rekreativno korišćenje i bazeni usmereni igrama u vodi;

TIP 2: bazeni kolektivnog korišćenja: su oni uvršteni u već opremljene strukture, uglavnom, za ostale prijemne aktivnosti (npr hotele, kamping, prijemne strukture, seoski turizam i slično) gde mogu ući samo gosti, mušterije, članovi i korisnici strukture, bazeni koji se identifikuju pošto su deo jedinstvenog kompleksa ili sačinjeni od građanskih korisnika ili koji su deo zajedničkih prostorija, koji sadrži više od četiri stambene jedinice, nezavisno od broja vlasnika namenjene u krajnjoj liniji da se koristi od strane onih koji žive u toj zgradi i njihovih gostiju, bazeni za rehabilitaciju i lečenje, smešteni u strukturama za lečenje ili rehabilitacije;

TIP 3: bazeni namenjeni isključivo na neke posebne namene, kao što su skokovi, vojna obuka, obuka za spašavanje i bazeni za ronioce.

CLASSIFICATION OF POOLS

For the purposes of this rule, the pools are classified as follows:

- **type 1:** public swimming pools, such as municipal swimming pools, recreational pools and pools for water play;
- **type 2:** swimming pools for collective use: they are those included in structures already used, in the main street, for other receptive activities (for example hotels, camping, accommodation complexes, farmhouses and similar) accessible only to guests, customers, members and users of the structure itself, swimming pools that are identified because they are part of a single complex or composed of residential or condominium, consisting of more than four units, regardless of the number of owners, intended exclusively for use by those who reside in such buildings and their guests, swimming pools for rehabilitation and curative purposes, located within a care or rehabilitation facility;
- **type 3:** swimming pools intended exclusively for certain specific uses, such as diving, military training, rescue training and swimming pools for divers

SVOJSTVA VODE

Voda za snabdevanje mora imati svojstva saobrazna važećem zakonodavstvu što se tiče kvaliteta voda namenjenih ljudskoj potrošnji.

WATER REQUIREMENTS

The water supply must be compliant with current legislation requirements concerning the quality of water intended for human consumption.

SVOJSTVA UREĐAJA

Uređaj za cirkulaciju, shvaćen kao komponente distribucije, t.j., c e v i i fitting, mora položiti proveru pritiska.

Uređaj za cirkulaciju mora proći proveru boje sa opisom prema standardima UNI EN 15288-1 sa Jednoobraznim hlorisanjem postignutim raggiunta u 15' minuta.

INSTALLATION REQUIREMENTS

The circulation system, intended as distribution components, that is, pipes and fittings, must pass the pressure test. The circulation system must pass the color test described in UNI EN 15288-1 with uniform chlorination achieved in 15' minutes

SKIMER

Upotreba skimera dozvoljeno je samo u bazenima tipa 2 koji imaju površinu $\leq 100\text{m}^2$, brojčano makar jedan skimer svakih 20 m^2 .

PAŽNJA: BAR IL 75% PROTOKA uređaja za cirkulaciju mora teći preko površinskog sistema povrata.

Skimeri moraju odgovarati propisima po tačkama 4.2.6 e 4.2.7 standarda UNI EN 13451-3 i moraju posedovati Probušenu korpicu koja se može vaditi i čistiti.

Skimeri se moraju pozicionirati sa maksimalnom razlikom međusobnog nivoa u kvoti $\pm 15\text{mm}$.

SKIMMER

The use of skimmers is allowed only in type 2 tanks with a surface of 100m^2 , with at least one skimmer per 20 m^2 .

Please note: at least 75% of the flow rate of the circulation system must flow through the surface recovery systems. Skimmers must meet the requirements of points 4.2.6 and 4.2.7 of UNI EN 13451-3 and must be equipped with removable perforated basket and can be cleaned.

Skimmers must be positioned with a mutual maximum level difference in 15mm altitude.

POTOPLJENI SISTEMI ZA POVRAT

Potopljeni sistemi za povrat moraju poštovati propise UNI EN 13451-3.

Da bi predupredili rizik da se bude usisano od strane potopljenih sistema za povrat moraju se poštovati propisi UNI EN 13451-1.

RECORDING SYSTEMS IMMERSSED

The submerged system must meet the requirements of EN 13451-3.

In order to prevent the risk of entrapment associated with immersed camera systems, the requirements of EN 13451-1 must be met.

KOMPENZACIONI REZERVOAR

Uobičajena zapremina kompenzacionog rezervoara mora se računati u funkciji vrste preliva i mora biti dovoljna da primi: pomešanu zapreminu od strane max broja kupaca u bazenu ; zapreminu vezanu za eventualni talasni nalet generisanu od samih kupaca prilikom predviđenih aktivnosti u bazenu, zapreminu u odnosu na eventualne aparate i opremu i talasno kretanje kreirano njihovom upotrebom; zapreminu vode sadržane u kanalu i/ili u prelivnim kolektorima izračunato projektom protoka; potrebnu zapreminu za pranje bar jednog filtera; minimalnu potrebnu zapreminu radi obezbeđenja korektnog usisavanja pumpi za recirkulaciju i da ne bi radile na suvo.

Nota 1: tokom pranja filtera poželjno je izbegavati reintegrisanje vode u kompenzacionom rezervoaru

Kompenzacioni rezervoar mora biti:

- Ne pristupačan kupcima
- Lako pristupačan osoblju zaduženom u radnjama održavanja i pranja;
- da se može potpuno isprazniti;
- opremljen opcijom "prepunjeno";
- realizovan sa namenskim rešenjima da bi se izbeglo da se eventualna ispuštanja iz istog sliju u druge ambijente;
- sa površinama koje se lako peru.

Nota 2: sistem upravljanja nivoima kompenzacionog rezervoara morao bi predvideti aktiviranje reintegracije vode Pre dostizanja minimalnog nivoa, da bi se izbegli prekidi rada tretmanskog postrojenja.

OVERFLOW TANK

The volume of the conventional compensation tank must be calculated as a function of the type of overflow and should be sufficient to contain: the displaced volume by the maximum number of bathers in the pool, the relative volume of the possible wave motion generated by bathers themselves in the activities provided in the pool, the volume relative to any devices and equipment and the wave motion generated by their use; the volume of water contained in the channel and/or in the collectors of overflow calculated at the design flow rate; the volume needed for the washing of at least one filter, the minimum volume necessary to ensure the correct suction of the recirculation pumps and to prevent dry running.

Note 1: During the washing of the filters must be prevented by replenishing water in the overflow tank

The overflow tank should be:

not accessible to swimmers; easily accessible to operations people for maintenance and cleaning; completely evacuable; equipped with overflow; realized with special precautions in order to avoid that any emissions from the same flow into other environments; with easily washable surfaces.

Note 2: the management system of the levels of the compensation tank should provide for the activation of the replenishment of water before reaching the minimum level, to avoid interruptions of operation of the treatment plant.

SISTEMI NAPAJANJA VODE KOD DOLIVANJA I OBNAVLJANJA

Prelivni bazeni bilo koje vrste i bazeni tipa 2 sa skimerom moraju biti opremljeni automatskim uređajem za reintegrisanje i obnavljanje prepunjenosti.

Nota: automatski uređaj za reintegrisanje i obnovu i prepunjenost savetuju se za bazene sa skimerom tipa C.

Na uređaju za reintegrisanje i obnovu bazena tipa 1 i 2, mora se instalirati brojilo za proveru realno ubačene zapremine vode. Protok sistema za reintegraciju i obnavljanje vode mora biti dovoljan da dovede odgovarajuće količine za predviđene ciljeve.

SUPPLY SYSTEMS UP WATER AND RENEWAL

The infinity edge pools and swimming pools of any kind of type A2 and B with skimmer, shall be equipped with an automatic replenishment and renewal of overflow.

Note: the automatic replenishment and renewal and the overflow is recommended for pools with skimmer type C. On the plant make-up and renewal of the pools of type A and B, must be installed a counter for the verification of the volume of water actually placed.

The system flow rate of water renewal and reinstatement shall be sufficient to state the relative amounts of the intended purposes as defined in paragraphs 3.5, 3.6 and 3.7.

KLASIFIKACIJA BAZENA - CLASSIFICATION OF POOLS		
Vrste bazena		Bazen tipa 1 - tipo 2 - tipo 3
A	Zone za skakanje i podvodne aktivnosti sa dubinom ≥ 3 m <i>Digs and diving activities areas with depth ≥ 3 m</i>	6
B	Bazeni za plivače sa dubinom > 1.35 m, omologabili per competizioni ufficiali <i>Swimming pools with a depth > 1.35 m, homologated for official competitions</i>	4
C	Zone sa dubinom > 1.35 m, escluse le vasche di cui al punto B <i>Areas with a depth > 1.35 m, excluding the pools referred to in point B</i>	3
D	Zone sa dubinom > 0.6 m e ≤ 1.35 m <i>Zones with depths > 0.6 m and ≤ 1.35 m</i>	2.5
E	Zone sa dubinom > 0.4 m e ≤ 0.6 m <i>Zones with depths > 0.4 m and ≤ 0.6 m</i>	1
F	Zone sa dubinom ≤ 0.4 m <i>Zones with depths ≤ 0.4 m</i>	0.5
G	Bazeni sa talasima <i>Pool with waves</i>	2
H	Zona za ulazak u vodu sa tobogana * <i>Landing zone waterslides</i>	1
I	Reke/potoci sa dubinom ≤ 0.8 m <i>Rivers/streams with depth ≤ 0.8 m</i>	1
J	Reke/potoci sa dubinom > 0.8 m <i>Rivers/streams with depth > 0.8 m</i>	2
K	Bazeni za rehabilitaciju <i>Pools for use in rehabilitation</i>	**

* Za zone za ulazak u vodu sa tobogana kako definišano standardima UNI EN 1069-1, zapremina na koju se aplicira vreme recirkulacije mora se računati imajući u vidu dubinu di 1 m. U slučaju prisustva tobogana posebne vrste (npr. sa spustom in catch unit, kako po standardima UNI EN 1069-1, ili slično) vreme recirkulacije mora biti u skladu s tim smanjeno, u funkciju upotrebe strukture.

** Apliciraju se vremena recirkulacije datog prospekta, držeći se eventualni restrikcija koje se definišu sa zdravstvenom direkcijom u sedištu projektovanja, u vezi upotrebne destinacije uređaja i tipologije korišćenja.

* For waterslide ditching areas as defined by UNI EN 1069-1, the volume to which the recirculation time must be applied must be calculated considering the conventional depth of 1 m. In the case of the presence of special type of water slides (for example, with arrival in catch unit, as defined in UNI EN 1069-1, or similar situations) the recirculation times must be adequately reduced, depending on the use of the structure.

** The recirculation times of this prospectus apply, without prejudice to any restrictions to be defined with the health management during the design phase, in relation to the intended use of the plant and the type of user.

1) za identifikaciju tipa bazena, vezati se za prevalentnu aktivnost koja rezultira iz protokola upravljanja i autokontrole

2) Parametar za naznaku u sedištu projektovanja, vezano sa destinacijom upotrebe uređaja i vrste korišćenja

1) to identify the type of tank, refer to the prevalent activity as indicated by the management protocol and self-control

2) Parameter to be indicated in the design, in relation to the intended use of the system and the type of users

Nota 1: Vremena recirkulacije iskazane su maksimalne vrednosti, koje se odnose na špicu poseta kupaca manje ili jednake jednoj osobi Svaka 3 m² površine bazena. Morali bi se adekvatno smanjiti u slučaju velike posete kupaca bazenu, kako u numeričkim apsolutnim terminima Tako i vremenskoj učestalosti i u odnosu na zapreminu vode (npr značajno prisustvo di zonama hidro/aero-masažnim).

Note 1: The recirculation times listed are maximum, referring to experiences of a less peak attendance of swimmers equal to one person per 3m² of pool area. Should be suitably small in the case of swimming pools to high load of swimmers, both in terms of absolute numerical, hourly and in relation to the volume of water (for example the presence of significant areas hydro / aeromassage).

U slučaju višenamenskih rezervoara ili različitih dubina, ukupni protok uređaja mora se računati:

- dodajući zapremini svake površine rezervoara, različitih namena i dubine, jedan proporcionalni procenat konvencionalne zapremine kompenzacionog rezervoara;
- apilirajući svakoj zapremini kako gore integrisano predviđeno vreme recirkulacije iz prospekta 3;
- sumirajući tako izračunate protoke

U slučaju da su prerdviđene razne mogućnosti korišćenja jednog rezervoara ili jedne zone rezervoara, zbog dimenzioniranja uređaja mora se imati u vidu aktivnost koja predviđa niži nivo recirkulacije.

Uređaj za recirkulaciju mora biti dimenzioniran zonu po zonu, da bi se garantovalo u svakoj zoni vreme recirkulacije. U slučaju jednog jedinog uređaja za tretman koji opslužuje veći broj rezervoara, za svaki mora biti ispoštovano vreme recirkulacije.

In case of multi-purpose pools or different depths, the total flow system must be calculated:

- adding to the volume of each area of the basin, with different uses, or depth, a proportional percentage of the conventional volume of the overflow tank;
- applying to each volume as so supplemented recirculation time specified in the prospectus 3;
- performing the summation of the capacities as calculated.

In the case in which different possibilities of use of the same tank or an area of a bathtub are provided, for the purpose of dimensioning of the plants must be regarded as the activity that provides the time of bottom return.

The recirculation system must be sized by zone, to ensure in every area of recirculation the time.

In the case of a single treatment plant to the service of more tanks, for each must be respected the recirculation time.

FILTERI

Za svaki tretmanski uređaj mora se instalirati jedan broj filtera ≥ 2 istih karakteristika. Za bazene tipa $2 \leq 100$ m² i filteri su dozvoljeni u broju ≥ 1 istih karakteristika.

FILTERS

For each treatment plant, an equivalent number of filters shall be installed. For pools type 2 100 m² filters are allowed in number 1 with equivalent characteristics.

CIRKULACIONE PUMPE

Cirkulacione pumpe moraju garantovati projektovani protok tretmanskog uređaja, imajući u vidu i 50% razlike u gubitku pritiska između čistog filtera i onoga koji se mora prati.

Filtracione pumpe moraju biti istog broja filtera ili sistema ultrafiltracije;

mora se instalirati i jedna dodatna pumpa sa upotrebom rotaciono po potrebi svakom filteru ili sistemima ultrafiltracije.

Svaka pumpa mora posedovati:

- Propusni ventil uzvodno i nizvodno;
- nizvodni manometar, radi verifikacije uslova rada iste;
- ako je potrebno, nepovratnog nizvodnog ventila.

CIRCULATION PUMPS

The circulation pumps must ensure the design flow rate of the treatment plant, taking into account also 50% of the difference in pressure loss between clean filter and to be washed.

The number of filtration pumps shall be equal to the number of filters or ultrafiltration systems; in addition, an additional pump shall be installed with rotational use for each filter or ultrafiltration systems.

Each pump must be equipped with:

- shut-off valves upstream and downstream;
- a pressure gauge downstream, in order to verify the conditions of employment of the same;
- and, if necessary, a check valve downstream.

PRISUSTVO IGARA U VODI

U slučaju bazena sa igrama u vodi protok recirkulacije mora biti povećan za 1 m³/h

Za svaku postavku. Recirkulacioni uređaj mora biti dimenzioniran zona po zoni, da bi se garantovalo u svakoj zoni vreme recirkulacije predviđen dal prospektom 3.

PRESENCE OF WATER GAMES

In the case of pools with water features

The recirculation flow rate shall be increased by 1 m³/h for each station.

The recirculation system must be dimensioned zone by zone, in order to guarantee in each zone the recirculation time foreseen in table 3.

KARAKTERISTIKE FILTERA TABLE 4 - CHARACTERISTICS OF FILTERS	
Mass filteri za bazene sa $500 \leq \varnothing \leq 1000$ mm <i>Mass filters for swimming pools with $500 \leq \varnothing \leq 1000$ mm</i>	Mass filteri za bazene sa $\varnothing > 1000$ mm <i>Mass filters for swimming pools with >1000 mm</i>
Mogu posedovati bilo koji sistem unutrašnje distribucije Koji bi garantovao jednoobrazan protok i takav da zaokupi komplet filtrirajuću masu. U slučaju da nije predviđen namenski držač (npr neka ploča) filtrirajuće mase moraju biti održavane od namenskog sloja granula postavljenih na dnu filtera i toliko visokog da pokrije povratni sistem isfiltrirane vode <i>They can be equipped with any internal water distribution system that ensures a uniform flow and such as to affect a the filtering masses. If no support is provided (for example a plate) the filter masses shall be supported by a special grit layer with a nominal particle size of 2 to 40 mm placed on the bottom of the filter and at least as high as to cover the filtered water recovery system as follows: - 50 mm from the top of filters of 800 mm; - 100 mm from the top of filters > 800 mm.</i>	Moraju imati nosač filtrirajuće mase i noseći oslonac pločasti, ili zvonast, sistem distribucije i povrata. Unutar filtera mora biti zagarantovan ujednačen protok, koji utiče na celokupnu sadržanu masu, kako za filtrirajuće tako i noseće. Noseći slojevi filtrirajuće mase nominalne granulacije od 2 do 40 moraju poštovati sledeće visine: ->100mm gornje kvote za pločasti sistem distribucije ->350mm gornje kvote za zvonasti sistem distribucije

NE MOGU SE KORISTITI FILTERI sa $\varnothing < 500$ mm. Filteri mass moraju imati šahtove/rukohvate/otvore u odgovarajućem broju i dimenzijama da bi se omogućio utovar i istovar mase i normalno održavanje podnog slivnika i vazdušnog ispusta.

Nota: protivstrujno pranje jednog mase filtera trebalo bi se predvideti kao normalna radnja, kako bi se uvek garantovala efikasnost a ipak pre nego što pad pritiska dođe do > 30 kPa upoređujući sa padom pritiska opranog filtera.

Can not use filters with a diameter <500mm. The filter masses must be equipped with manholes / handrail / openings in number and of adequate size to allow the loading and unloading of the masses and the normal maintenance of a bottom outlet and an air vent.

Note: the backwashing of a filter masses should be provided as normal operation, so as to always guarantee the efficiency and anyway before the pressure drop becomes > 30 kPa with respect to the pressure drop of the filter washed.

JEDNOSLOJNI PEŠČANI FILTERI

Jednoslojni peščani filteri moraju imati jedan jedini peščani filtrirajući sloj sa nominalnom granulometrijom od 0,4mm do 1,3 mm eventualno podržani sa jednim ili više slojeva granula .

Minimalna visina filtrirajućeg sloja iznad granula ili povratnog sistema vode mora biti kako naznačeno.

SAND FILTERS MONOLAYER

The sand filters monolayer should have a single filtering layer of sand with a particle size rated from 0.4 mm to 1.3 mm may be supported by one or more layers of grit.

The minimum height above the filter bed of gravel or water recovery system must be.

MINIMALNA VISINA FILTRIRAJUĆEG SLOJA MINIMUM HEIGHT OF THE FILTER LAYER	
Filteri sa prečnikom ≤ 1000 mm Za sve vrste bazena <i>Filters with a diameter ≤ 1000 mm for all types of pools</i>	600
Filteri sa prečnikom >1000 mm Za sve vrste bazena <i>Filters with a diameter > 1000 mm for all types of pools</i>	800

Brzina filtracije mora biti ≤ 35 m/h.

The filtration speed shall be 35 m/h.

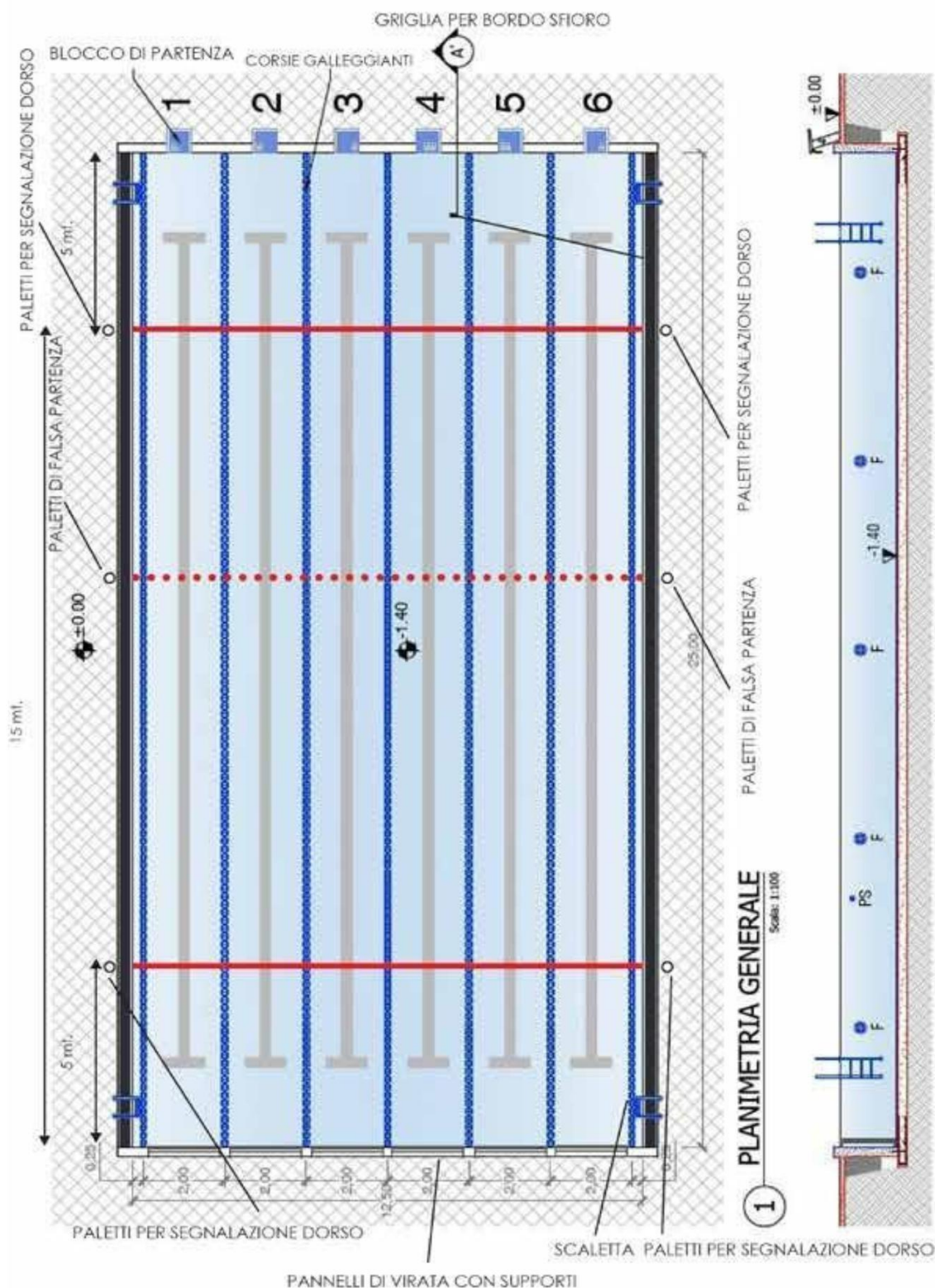

LEGENDA	
	Blocco di partenza
	Aspirazione di fondo meccanica piccolo
	Boccetta d'irrigazione
	Prisma di spazzola
	Prismine subacquee

FILTRI - FILTERS



VERDUNO

KARAKTERISTIKE | Features

modeli 630-1000
 filtr.površina(m²) min0,31 filtering surface(m²) max0,79
 protok 50 m/h (m³) min 15,5 50 m/h flow (m³) max 40



BLU HBS

modeli 650 - 1000
 models
 filtr.površina(m²) min0,18 filtering surface(m²) max0,76
 protok 50m/h(m³) min6,5 50m/hflow(m³) max26



TANARO

KARAKTERISTIKE | Features

modeli 800 - 1200
 models
 superficiefiltrante(m²) min0,50 filtering surface(m²) max1,13
 protok 35 m/h (m³) min 17,7 35 m/h flow(m³) max 40



DANUBIO

KARAKTERISTIKE | Features

modeli 1400 - 2500
 filtr.površina(m²) min1,54 filtering surface(m²) max6,92
 protok 35 m/h (m³) min 54 35 m/h flow(m³) max 168



POLARIS SIDE

modeli 800 - 1000
 models
 filtr.površina(m²) min0,49 filtering surface(m²) max0,77
 protok 35 m/h (m³) min 17 35 m/h flow(m³) max 27



ARENA

KARAKTERISTIKE | Features

modeli 1250 - 2400
 filtr.površina (m²) min 1,23 filtering surface (m²) max 6,52
 protok 35 m/h (m³) min 43 35 m/h flow(m³) max 228



EURO PA

KARAKTERISTIKE | Features

model 1200 - 2400
 models
 filtr.površina (m²) min 1,13 filtering surface (m²) max 4,52
 protok 50 m/h (m³) min 56 50 m/h flow(m³) max 226



ATLANTICO

KARAKTERISTIKE | Features

modeli 1000 - 2500
 models
 filtr.površina(m²) min0,79 filtering surface(m²) max4,91
 protok 35m/h(m³) min24,49 35 m/h flow(m³) max 171,80

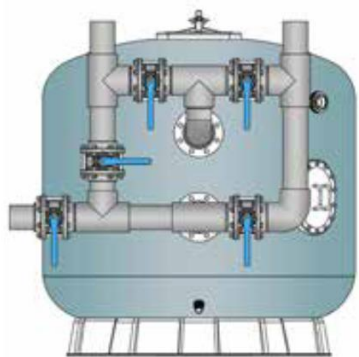

**BATERIJE ZA POVRATNO ISPIRANJE
BACKWASH BATTERIES**



**SKLOP URANO 1-2-3
URANUS GROUP 1-2-3**

PUMPA - PUMPS



AURORA

KARAKTERISTIKE | Features

modeli models	3 HP - 12,5 HP
Snaga kW power Kw	2,2 - 9,2
prefilter prefilter	Da Ne Yes and no



RIVER

KARAKTERISTIKE | Features

modeli models	4 HP - 20 HP
snaga kW power Kw	3 - 15
prefilter prefilter	Da Yes



GHISA NM / NM 4

KARAKTERISTIKE | Features

modeli models	3 HP - 12,5 HP
snaga kW power Kw	2,2 - 9,2
prefilter prefilter	Ne No

PREDFILETRI ODMAŠČIVAČI - PREFILTER



ABS / POLIPROPILENE

KARAKTERISTIKE | Features

materiale material	ABS polipropilene
PRIKLJUČAK (mm) attach (mm)	min ø 75 - DN 80 max DN150-DN150



INOX

KARAKTERISTIKE | Features

materijal material	inox stainless steel
priključak (mm) attach (mm)	min DN 100 max DN 250



Peščani filter za filtraciona postrojenja povezanih sa bazenom za javnu i privatnu upotrebu. Realizovan u laminat poliesteru ojačan sa fibroglassom, sa manometrom, ispustom vazduha i selekcionim ventilom na boku.

- Visina filtrirajućeg sloja: 1 metar
- Pritisak pri ispitivanju: 3,5 kg/cm²
- Max pritisak rada: 2,5 kg/cm²
- Max temperatura rada: 40° C

Sandfilterforfiltrationsystemsassociated with swimming pools for public and private use. Made of laminated polyester reinforced with fiberglass, complete with pressure gauge, air purge and selector valve on the side.

- Height of the filter bed: 1 meter
- Test pressure: 3.5 kg / cm²
- Maximum working pressure: 2.5 kg / cm²
- Maximum operating temperature: 40 ° C

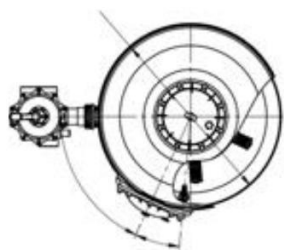

šifra/code	Opis/description	Cena/price
1080180	Verduno ø630 mm	2.149,00 €
1080181	Verduno ø710 mm	2.539,00 €
1080182	Verduno ø800 mm	3.388,00 €
1080183	Verduno ø900 mm	3.525,00 €
1080184	Verduno ø1000 mm	4.925,00 €

Model	Ø D mm	C mm	N mm	M mm	L mm	konektori Ø
630	630	1510	590	130	630	1 1/2"
710	720	1690	690	150	650	2"
800	800	1780	605	150	330	2"
900	900	1765	700	150	715	2"
1000	1000	1985	-	-	970	2 1/2"

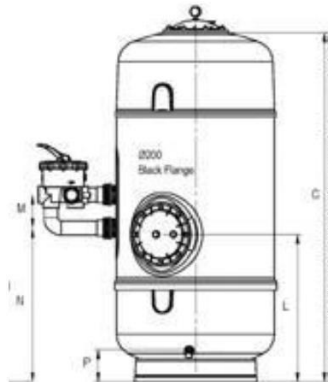

Verduno 630

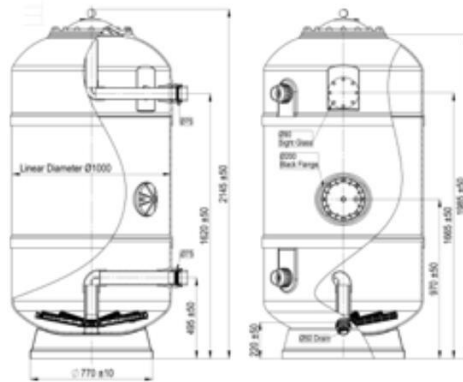

Verduno 1000

Model	PROTOK a vel. 35 m/h	PROTOK a vel. 50 m/h	Teži na kg
630	10,8 m ³ /h	15,5 m ³ /h	35,2
710	14 m ³ /h	20 m ³ /h	55,0
800	17,5 m ³ /h	25 m ³ /h	71,0
900	22,4 m ³ /h	32 m ³ /h	78,5
1000	27,6 m ³ /h	40 m ³ /h	95,0

Model	Filtrirana površina	Antracite 0,8 – 1,6 mm (l)	Pesak 0,5 – 1 mm (kg)	Pesak 1 – 3 mm (kg)
630	0,31 m ²	200	200	150
710	0,40 m ²	250	250	215
800	0,50 m ²	320	320	270
900	0,64 m ²	470	470	420
1000	0,79 m ²	580	580	577

BLU HBS RUČNI
BLUE HBS FILTERS WITH LATERALS



Blu Hbs bez bočnih vrata
Blu Hbs WITHOUT side opening



*na telo filtera i cevi
*for body filter and pipes



BluHbsSA bočnim vrat.
Blu Hbs WITH side opening

- Ručni filter namotan od fiberglasa sa unutrašnjom oblogom od fiberglasa i poliestera.
- Telo filtera sa tretmanom protiv-UV
 - Maksimalni korisni pritisak 2,5kg/cm²
 - Max radna temperatura 50°C
 - Unutrašnje cevi sa preseccima Ø63 mm
 - 6 položajni selektivni ventil
 - Poklopci na brzo otvaranje i providna nadzorna kapica (izuzev mod.1000)
 - Spojnice na lepljenje manometar per za praćenje unutrašnjeg pritiska.
 - Ventil za brzo pražnjenje
 - Visina filtrirajućeg sloja 650/750 mm
 - U skladu sa normama UNI10637

- Coiled laterals filter in fiberglass with fiberglass and polyester liner
- Filter body with anti-UV
- Maximum pressure of use: 2.5 kg/cm²
- Maximum operating temp. 50° C
- Pipes sections with inner diameter of Ø63 mm
- 6-way selector valve
- Covers with fast opening and cap with transparent inspection (except mod.1000)
- Pressure gauge bonding fittings for internal pressure monitoring
- Quick exhaust valve
- Filter bed height 650/750 mm
- IN ACCORDANCE WITH UNI 10637

Šifra/code	Opis/description	Cena/price
1080498	Blu Hbs 500 sa ventilom 1"½	764,60 €
1080499	Blu Hbs 650 sa ventilom 1"½	897,00 €
1080500	Blu Hbs 750 sa ventilom 2"	1.239,00 €
1080501	Blu Hbs 900 sa ventilom 2"	1.495,00 €
1080515	BluHbs1000sa ventilom 2" bez bočnih vratanaca with valve 2" without side opening	1.892,00 €
1080511	BluHbs1000 sa ventilom 2"½ sa bočnim vrat.	2.477,00 €

Mod.	Ø nom. mm	Spojevi in-out mm	Ventil selekc. inc	Visina filtr. sloja mm	Filtr. površ inam ²	Protok m ³ /h [Vel. 35m/h]	Protok m ³ /h [Vel. 50m/h]	Pesak kg	Granulat kg	Teži na kg
650	650	50	1" ½	650	0,321	11	16	215	38	26
750	750	63	2"	750	0,427	15	21	298	53	45
900	900	63	2"	750	0,619	21	31	429	76	52
1000	1000	75	2" ½	750	0,765	26	38	530	94	73

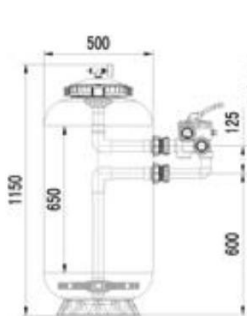

BluHbs500

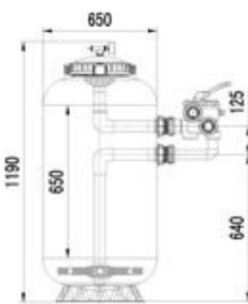

BluHbs650



Blu Hbs750

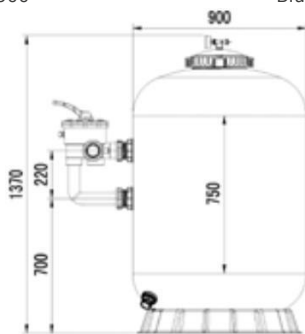

BluHbs900

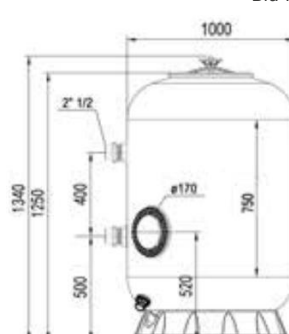

Blu Hbs 1000 cod. 1080511

*Prikazane mere imaju se smatrati kao nominalne/**Vrednosti,slike i šeme date su samo informativno

TANARO PLOČASTI SA DIFUZORIMA TANARO NOZZLE PLATE FILTERS WITH DIFFUSERS



Namotani filteri, unutrašnja obloga od poliestera i fibreglasa. Potpuno antikorozivni, visoka mehanička, termička i na hemijske proizvode, otpornost.

Jedna od njegovih glavnih karakteristika je visina sloja za filtraciju: prljavština provučena kroz sloj peska stišnjena je u malim prostorima u granulama peska. Prvo će jedan čisti sloj odstraniti veće čestice, zatim će filtrirajući dublji sloj odstraniti najsitnije čestice. Veća visina filtracionog sloja omogućava veći učinak.

U SKLADU SA NORMAMA UNI 10637
SA INSPEKCIJSKIM BOČNIM OTVOROM

Filters with coils, lining of polyester and fiber glass. Completely anti-corrosion, high mechanical thermal and chemical products strength.

One of its main features is the height of the filter: the dirt carried through the bed of sand is trapped in the tiny spaces between the grains of sand.

Initially a clean layer removes larger particles, then the filtering layer deeper remove finer particles. Greater height of the filter bed for added performance.

IN ACCORDANCE WITH UNI 10637, SIDE HATCH INSPECTION INCLUDED

Šifra/ code	Opisdescription	Cena/ price
1080280	Tanaro 800	3.024,00 €
1080281	Tanaro 900	3.588,00 €
1080282	Tanaro 1000	4.186,00 €
1080283	Tanaro 1200	5.561,40 €

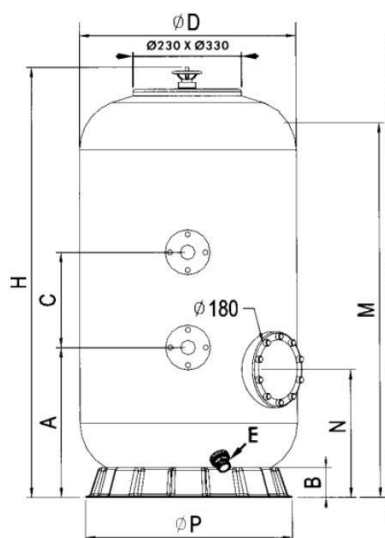

Model	Ø D mm	H mm	B mm	A mm	C mm	E mm	N mm	M mm
800	800	1600	-	550	350	60	550	1330
900	900	1600	150	550	350	60	520	1330
1000	1000	1600	150	550	350	60	520	1330
1200	1200	2100	190	650	350	60	600	1330

Model	Pritisak pri ispitivanju kg/cm ²	Pritisak max rada kg/cm ²	T max rada °C	Filtr.površina m ²	Protokm ³ /h [Vel.35m/h]	Protok m ³ /h [Vel.40m/h]
800	6	4	50	0,50	17,7	20
900	6	4	50	0,63	22	25
1000	6	4	50	0,78	27,3	31
1200	6	4	50	1,13	40	45

Model	h filter,sloj [m]	Pesak Ø 0,4-0,8mm [kg]	Granuli Ø 3-5 mm [kg]	Spoj Ø [mm]	Masa [kg]	Masa u funkciji [kg]
800	0,7	405	70	63	85	-
900	0,7	515	75	63	95	1210
1000	0,7	636	90	63	105	1460
1200	1,1	1221	265	90	197	2637

*Navedene mere imaju se smatrati kao nominalne dimenzije ** Vrednosti, reprodukovane slike i šeme imaju samo informativni karakter
*The measurements are to be considered as nominally ** values, images and diagrams reproduced are only shown for information

PLOČAST DANUBIO VISOKOG FILTRACIONOG SLOJA
NOZZLE PLATE FILTERS DANUBIO WITH HIGH SAND BED



Namotani filteri od poliestera i fibreglasa, poseduju noseće ploče filtracione mase i inspeksijski bočni otvor. Ispust vazduhana ručno aktiviran je ugrađen na poklopcu. Razdaljina između gornjeg dela sloja peska i glave difuzora proučena je da omogući optimalnu distribuciju vode u fazi filtracije. Okruglo prozorče za nadzor smešteno na filteru. SA INSPEKCIJSKIM BOČNIM OTVOROM U SKLADU NORMAMA UNI 10637:2016

- Pritisak ispitivanja 3,8 kg/cm²
- Maksimalni pritisak rada 2,5 kg/cm²
- Maksimalna radna temperatura 50 °C
- Gubitak pritiskasa čistim filterom < 50 kPa

Filters with coils in polyester and glass fiber equipped with the support nozzle plate of filtering masses and lateral inspection passes-man. Air-bleed manually operated inserted on the lid. The distance between the top of the layer of sand and the head of the diffuser is designed to ensure an optimum distribution of water in the filtration stage. Sight glass placed on the filter. Hatches side inspection including IN ACCORDANCE WITH UNI 10637:2016

- Test pressure 3,8kg/cm²
- Maximum working pressure 2,5 kg/cm²
- Maximum working temperature 50°C
- Pressure drop at clean filter < 50 kPa

DIMENZIJE / DIMENSIONS

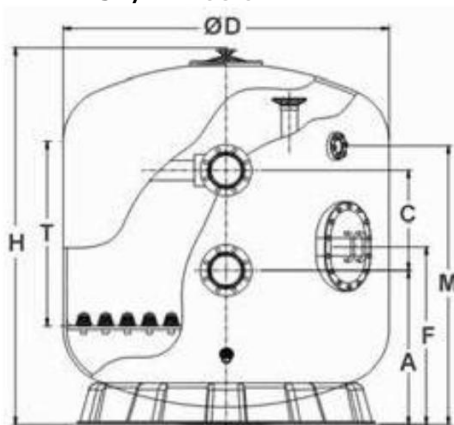

Šifra/code	Opis/description	Cena/price
1080260	Danubio 1400	8.509,00 €
1080261	Danubio 1600	10.533,00 €
1080262	Danubio 1800	13.199,00 €
1080263	Danubio 2000	14.313,00 €
1080264	Danubio 2300	21.143,00 €
1080265	Danubio 2500	NA UPIT

Model	ØD ext. [mm]	H [mm]	A [mm]	C [mm]	F [mm]	M [mm]	T [mm]
D. 1400	1420	1890	700	550	830	1400	1000
D. 1600	1625	2000	810	550	900	1500	1000
D. 1800	1830	2100	850	550	980	1600	1000
D. 2000	2035	2200	900	550	1030	1650	1000
D. 2300	2300	2350	940	600	1070	1800	1000
D. 2500	2500	2400	960	600	1100	1900	1000

Model	h filtr. sloj [m]	Filtr. površina [m ²]	Protok m ³ /h [Vel. 35m/h]	Protok m ³ /h [Vel. 40m/h]	Pesak Ø 0,4-0,8mm [kg]	Granuli Ø 1-2 mm [kg]	Granuli Ø 3-5 mm [kg]	Spoj Ø mm	Masa filter [kg]	Masa u funkciji [kg]
D. 1400	1,0	1,54	54	61	1665	225	200	110 (4")	345	3170
D. 1600	1,0	2,01	70	80	2170	300	275	160 (6")	410	3935
D. 1800	1,0	2,54	89	101	2750	375	350	160 (6")	542	4867
D. 2000	1,0	3,14	110	125	3395	475	450	160 (6")	585	5815
D. 2300	1,0	4,07	142	162	4475	600	475	200 (8")	943	8528
D. 2500	1,0	4,80	168	192	5275	700	550	200 (8")	1200	10125

DANUBIO SA VIŠESLOJNIM MASA HETEROGENIM PUNJENJEM
DANUBIO MULTIPLY HETEROGENEOUS MASSES CHARGED

H filtr. sloj m	Filtr. sredstvo Ø mm
0,1	Granule 3-5
0,1	Granule 1-2
0,5	Pesak 0,4-0,8
0,3	Antracite 1,2-2,5



*Naznačene mere imaju se smatrati kao nominalne dimenzije ** Vrednosti, reprodukovane slike i šeme imaju samo informativni karakter
 *The measurements are to be considered as nominally ** values, images and diagrams reproduced are only shown for information

POLARIS SIDE RUČNI FILTER SA VISOKIM FILTRIRAJUĆIM SLOJEM

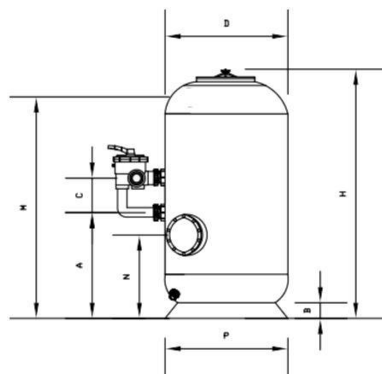

Namotani filteri iznutra presvučeni poliesterom i fiber glasom, potpuno antikoroziivnime i otporni na sve hemijske proizvode. Visoka termička i mehanička otpornost.

Sloj granula (od 3 do 5 mm) na dnu omogućava bolju distribuciju vode u difuzori i zatim novi sloj peska sa granulazom od 0,4 a 0,7 mm. Obezbeđuje savršeno odstranjenje nečistoće.

Sono dotati di diffusore a candelotti, boccaporto laterale d'ispezione e svuotamento con chiusura a dado, manometro e valvola seletttrice del diametro di 2".

SAOBRAZNO NORMI UNI 10637:2016

Coiled filters, lined in polyester and fiberglass, completely corrosion-proof and resistant to all chemicals.

High mechanical strength and thermal. The layer of grit (from 3 to 5 mm) on the bottom allows a better distribution of the water to diffusers sticks, and then another layer of sand-particles size from 0,4 to 0,7 mm. Ensures perfect retention of the impurities. They are fitted with diffuser sticks, side hatch inspection and emptying with locking nut, selector valve and pressure gauge with a diameter of 2".

IN ACCORDANCE WITH UNI 10637:2016

Šifra/code	Opis/description	Cena/price
1080300	Polaris Side 800	2.426,00 €
1080301	Polaris Side 900	2.648,00 €
1080302	Polaris Side 1000	2.947,00 €

Model	D mm	H mm	B mm	A mm	C mm	P mm	N mm	M mm
Polaris Side 800	800	1600	150	700	220	690	520	1330
Polaris Side 900	900	1600	150	700	220	760	520	1330
Polaris Side 1000	1000	1600	190	700	220	830	600	1330

Model	Pritisak Ispitivanja kg/cm ²	Pritisak max rada kg/cm ²	Radna T max °C	Površina filtr. m ²	Protok m ³ /h [Vel. 35m/h]	Protok m ³ /h [Vel. 40m/h]
Polaris Side 800	4,0	2,5	40	0,49	17	19,5
Polaris Side 900	4,0	2,5	40	0,62	21,5	25
Polaris Side 1000	4,0	2,5	40	0,77	27	31

Model	h sloj filtr. m	Pesak Ø 0,4-0,7 mm [kg]	Granule Ø 3-5 mm [kg]	Spoj Ø mm	Massa kg	Masa Kompl. U funkciji kg
Polaris Side 800	0,7	405	60	63 (2")	69	970
Polaris Side 900	0,7	515	75	63 (2")	73	1200
Polaris Side 1000	0,7	635	90	63 (2")	85	1450

FILTER SERIJE EUROPA NAMOTANI

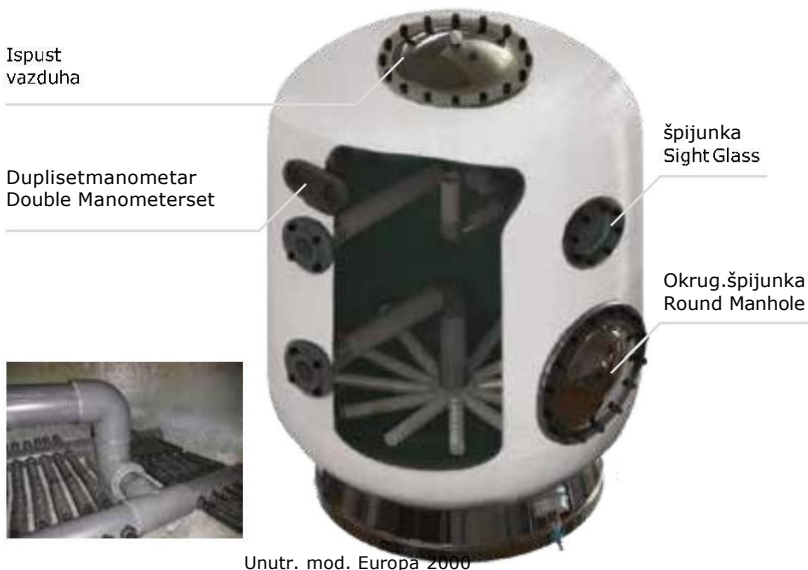

Unutr. mod. Europa 2000
Mod. Europa 2000 inside

D

- Telo filtera od ojačanog poliestera spoljnim omotom bobine fibreglasom
- Sa manometrom, ventilom za ispuštavanje vazduha 1/2"
- Probni pritisak 4,0 kg/cm². Max. Radni pritisak 2,5 kg/cm²
- Brzina filtracije: 40 m³/h/m².
- Dubina filtracije: 1,0 m

- Filter shell made of FR Polyester and reinforced by fiberglass bobbin winding outside.
- Complete with pressure gauge, air release valve of 1/2".
- Test pressure 4,0 kg/cm². Max. operation pressure 2,5 kg/cm².
- Filtration rate: 40m³/h/m².
- Filtration bed depth: 1,0m

DIMENZIJE / DIMENSIONS

Model	D mm	H ₁ mm	H ₃ mm	H ₄ mm	H mñ
1200	1200	1560	1500	520	880
1400	1400	1560	1500	600	950
1600	1600	1860	1800	640	1200
1800	1800	2050	1990	700	1300
2000	2000	2160	2100	770	1400
2200	2200	2300	2240	900	1530
2400	2400	2660	2600	900	1700



Šifra	Model	Priključci in/out mm	Pesak Sand	Površina filtr. m ²	Protok m ³ /h V=50 m ³ /h/m ²	Teži na Kg	Cena
1080384	Filter serije Europa bobinano 1200 Filter series Europa coiled 1200	90	1500	1,13	56	110	6.829,00 €
1080385	Filter serije Europa bobinano 1400	110	1950	1,54	77	180	7.628,00 €
1080386	Filter series Europa coiled 1400 Filter serije Europa bobinano 1600	125	2750	2,01	100	240	8.875,00 €
1080387	Filter series Europa coiled 1600 FilterserijeEuropa namotan 1800* Filter series Europa coiled 1800	140	3650	2,54	127	275	11.209,00 €
1080388	FilterserijeEuropa namotan 2000* Filter series Europa coiled 2000	160	4750	3,14	157	300	13.582,00 €
1080389	Filterseries Europa coiled 2200	200	5700	3,8	190	425	17.138,00 €
1080390	Filterseries Europa coiled 2400	200	6400	4,52	226	535	20.924,00 €

*Kompletan sa bočnim otvorom Ø400 mm
*Complete with lateral manhole Ø400 mm

FILTER SERIJE ATLANTICO NORMATIVA UNI

PEŠČANI FILTER (secondo DIN 19605 e 19643).

Telo filtera od poliestera ojačan fiberglassom sa namotajem od fiberglassa. Sa manometrom, ispustom vazduha i višestrukim ventilom. Ploča za skupljanje i mlaznice. Špijunka i bočni otvor. Dubina: 1,20 m. Probni pritisak 3,5 kg/cm². Max. radni pritisak 2,5 kg/cm². Brzina filtracije: singl sloj (kvarcni pesak): 30 m³/h/m². Višeslojni (kvarcni pesak + antracit i / ili zeolit): 40 m³/h / m².

SAND FILTERS (According to DIN 19605 and 19643).

Filter shell made of fiberglass reinforced laminated polyester by fiberglass bobbin winding. Including pressure gauge, air purge and multiport valve. Collector plate with nozzles. Sight glass and side manhole at side. Bed depth: 1,20m. Test pressure 3,5 kg/cm². Max.

operation pressure 2,5 kg/cm². Filtration Rate: Single Layer (Quartz Sand) : 30 m³/h/m². Multilayer (Quartz Sand + Anthracite and/or zeolite) : 40 m³/h/m².



Distributivni sistem ploče mlaznice
Nozzle plate distribution system

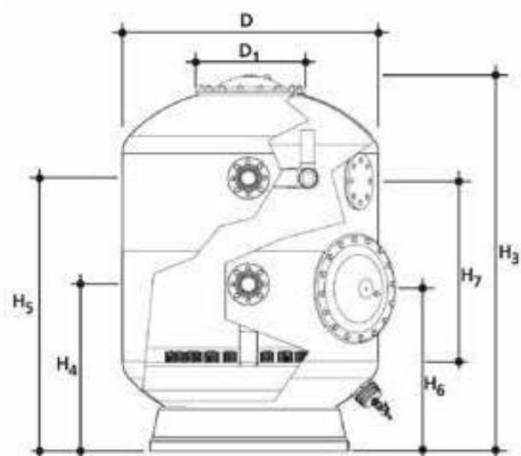

DIMENZIJE/ DIMENSIONS

Model	D mm	H ₃ mm	H ₄ mm	H ₅ mm	H mm
1000	1000	1650	680	1180	360
1200	1200	1985	720	1220	950
1400	1400	1985	800	1300	950
1600	1600	2030	800	1300	950
1800	1800	2070	800	1350	950
2000	2000	2180	950	1550	950
2400	2400	2680	950	1700	1000
2500	2500	2580	950	1700	1000

Šifra	Model	spojevi in/out mm	Pesak Sand	Protok m ³ /h V=35 m ³ /h/m ²	Poroto k m ³ /h V=50 m ³ /h/m ²	Filtr.površina m ²	Cena
1080391	Filter Atlantico 1000 FilterAtlantico1000	90	1100	27,49	39,27	0,79	5.539,00 €
1080392	Filter Atlantico 1200 FilterAtlantico1000	90	1583	38,75	55,35	1,11	9.339,00 €
1080393	Filter Atlantico 1400 FilterAtlantico1000	110	2155	52,05	74,35	1,49	10803.723,00 €
1080394	Filter Atlantico 1600 FilterAtlantico1000	125	2815	70,37	100,53	2,01	12.294,00 €
1080395	Filter Atlantico 1800 FilterAtlantico1000	140	3562	89,06	127,23	2,54	17.359,00 €
1080396	Filter Atlantico 2000 FilterAtlantico1000	160	4398	109,95	157,08	3,14	21.088,00 €
1080397	Filter Atlantico 2400 FilterAtlantico1000	200	6333	158,33	226,19	4,52	35.152,00 €
1080398	Filter Atlantico 2500 FilterAtlantico1	200	6872	171,8	245,43	4,91	43.953,00 €

POVRATNE BATERIJE NA RUČNO I AUTOMATSKO UPRAVLJANJE
BACKWASH BATTERIES WITH MANUALLY OPERATIONS AND AUTOMATIC BACKWASH BATTERIES

Baterije za povratno ispiranje opremljene su šrafovim od pocinčanog čelika (Inox na upit) i isporučene za lepljenje. Backwashes in galvanized steel (stainless steel on request) and delivered to paste.

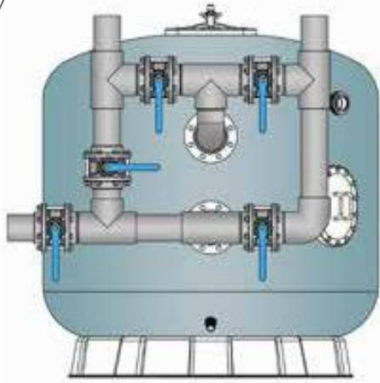

Povratna baterija
Backwash Battery



Cod. 1080110
Ploča sa dva manometra
Plate with two pressure gauges



Cod. 1080104
Podesivi nosač
Adjustable support



Baterija sa pneum.pokretanjem
Batteries with pneumatically operation



Povratna baterija sa elektro pogonom
Electric actuated Backwash battery

Šifra	Model	Cena ručno	Cena pneumatički
1080114	Povratne baterije sa 5 leptir. ventila inPVC/Ø75/backwash battery with 5 throttle valves PVC Ø75	1.843,00€	
1080115	Povratne baterije sa 5 leptir ventila inPVC/Ø90/backwash battery with 5 throttle valves PVC Ø90	2.112,00€	
1080116	Povratne baterije sa 5 leptir ventila inPVC/Ø110/backwash battery with 5 throttle valves PVC Ø110	2.396,00€	Na upit
1080117	Povratne baterije sa 5 leptir ventila PVC/Ø125/backwash battery with 5 throttle valves PVC Ø125	3.534,00€	Na upit
1080118	Povratne baterije sa 5 leptir ventila inPVC/Ø140/backwash battery with 5 throttle valves PVC Ø140	4.244,00€	Na upit
1080119	Povratne baterije sa 5 leptir ventila inPVC/Ø160/backwash battery with 5 throttle valves PVC Ø160	4.795,00€	Na upit

OPREMA

1080104	Podesivi nosač za povratne baterije Ø 90 / adjustable support of the plate Ø 90	451,00 €	-
1080106	Podesivi nosač za povratne baterije Ø 110 / adjustable support of the plate Ø 110	451,00 €	-
1080108	Podesivi nosač za povratne baterije Ø 125 / adjustable support of the plate Ø 125	457,00 €	-
1080109	Podesivi nosač za povratne baterije Ø 140 / adjustable support of the plate Ø 140	457,00 €	-
1080105	Podesivi nosač za povratne baterije Ø 160 / adjustable support of the plate Ø 160	564,00 €	-

ZAMENA

1080110	Ploča sa dve manometra > Ø160 (Danubio 1600-1800-2000) / plate with two pressure gauges	120,80 €	-
1080111	Ploča sa dva manometra ≤ Ø110 (Tanaro e Danubio 1400) / plate with two pressure gauges	120,80 €	-

Šifra	Opis	Cena automatska
POVRATNE AUTOMATSKE BATERIJE		
1080140	Povratna baterija sa 5 ventila sa elektr.pogonom Ø 50 / backwash battery with 5 electric-actuated valves Ø 50	Na upit
1080141	povratna baterija sa 5 ventila sa elektr.pogonom Ø 63 / backwash battery with 5 electric-actuated valves Ø 63	Na upit
1080142	Povratna baterija sa 5 ventila sa elektr.pogonom Ø 75 / backwash battery with 5 electric-actuated valves Ø 75	Na upit
1080139	Povratna baterija sa 5 ventila sa elektr.pogonom Ø 90 / backwash battery with 5 electric-actuated valves Ø 90	Na upit
1080120	Povratna baterija sa 5 ventila sa elektr.pogonom Ø 110 / backwash battery with 5 electric-actuated valves Ø 110	Na upit
1080121	Povratna baterija sa 5 ventila sa elektr.pogonom Ø 140 / backwash battery with 5 electric-actuated valves Ø 140	Na upit
1080122	Povratna baterija sa 5 ventila sa elektr.pogonom Ø 160 / backwash battery with 5 electric-actuated valves Ø 160	Na upit
1080123	Povratna baterija sa 5 ventila sa elektr.pogonom Ø 200 / backwash battery with 5 electric-actuated valves Ø 200	Na upit

SKLOP URANO 1-2-3
URANUS GROUP 1-2-3



SKLOP URANO SA POSTOLJEM, SASTAVLJEN OD 2 FILTERA, 3 PUMPE I BATERIJE ZA POVRATNO ISPIRANJE.

SKLOP Urano 1: 2 filtera TANARO 1200 namotani, sa filtracionim pločom, unutrašnjom oblogom od poliestera i fiberglasa / 3 pumpe AURORA 4,00 HP sa predfilterom polipropilenskim ojačanim fiberglasom / baterija povratnog ispiranja d.90 sa 5 leptirastih ventila / usisni kolektor d.125.

SKLOP Urano 2: 2 filtera DANUBIO 1400 namotani, sa filtracionom pločom, unutrašnjom oblogom od poliestera i fiberglasa / 3 pumpe AURORA 5,50 HP sa predfilterom od polipropilena ojačanim fiberglasom / baterija povratnog ispiranja d.110 sa 5 leptirastih ventila / usisni kolektor d.125.

SKLOP Urano 3: 2 filtera DANUBIO 1600 namotani, sa filtracionom pločom, unutrašnjom oblogom od poliestera i fiberglasa / 3 pumpe AURORA 5,50 HP sa predfilterom od polipropilene ojačanim fiberglasom / baterija povratnog ispiranja d.125 5 leptirastih ventila / usisni kolektor d.160.

URANUS GROUP WITH BASE, CONSISTING OF 2 FILTERS, 3 PUMPS AND BATTERY BACK WASH.

Uranus Group 1: 2 filters TANARO 1200 coiled with filtration nozzle plate, polyester liner with and glass fiber / 3 pumps AURORA 4.00 HP with polypropylene prefilter reinforced with glass fiber / backwash battery d.90 with 5 butterfly valve / manifold suction d.125.

Uranus Group 2: 2 filters DANUBIO 1400 coiled with filtration nozzle plate, polyester liner with glass fiber / 3 pumps AURORA 5.50 HP with pre-filter made of polypropylene with glass fiber / battery backwash d.110 with 5 butterfly valve / manifold suction d.125.

Uranus Group 3: 2 filters DANUBIO 1600 coiled with filtration nozzle plate, liner in polyester and fiberglass / 3 pumps AURORA 5.50 HP with polypropylene prefilter reinforced with glass fiber / battery backwash d.125 with 5 butterfly valve / manifold suction d.160.

Model	Šifra	Brzina filtr. m/h	Protokm3/h	Brzina filtr. m/h	Protok m3/h	Cena
Urano 1	1080297	35	80	40	90	23.688,00 €
Urano 2	1080298	35	108	40	122	30.583,00 €
Urano 3	1080299	35	140	40	160	36.528,00 €

SERIE AURORA SA I BEZ PREFILTERA
AURORA SERIES WITH OR WITHOUT PREFILTER



Seriya Aurora sa prefilterom
 Aurora series with prefilter



Serie Aurora bez prefiltera
 Aurora series without prefilter



Upotreba

- Protok vode u sistemima Filtracije bazena
- Idealan za velike protoke niskog pritiska

Telo

- Telo pumpe i prefilter od polipropilena ojačano fiberglassom
- Plastični rotor
- Kardan i korpica prefiltera od Inox čelika

Motor

- Trofazni motor sa obrtom 3000 r.p.m.
- 230/400Vo380/600V(modellisa snagom većom od7,5 HP), 50 Hz
- Zaštita IP 55
- Klasa izolacije F

Uses Watercirculationin swimmingpool filtration systems

- Ideal for high flow at low pressure

Body

- Body pump and pre-filter made of reinforced polypropylene with fiberglass
- Plastic impeller Shaft and pre-filter drum in stainless steel

Motor

- Three-phasemotor-rotating at 3000 r.p.m.
- 230/400 V or 380/600 V (models with higher power to 7.5HP), 50Hz
- IP-55 protection
- Class-F insulation

Šifra/ code	Opis/description	Cena/ price
PUMPAURORASA PREFILTER/PUMPAURORAWITHPREFILTER		
1090184	Pumpa Aurora sa prefilterom 3 HP / pump with prefilter 3 HP	1.145,50 €
1090170	Pumpa Aurora sa prefilterom 4 HP / pump with prefilter 4 HP	1.564,00 €
1090171	Pumpa Aurora sa prefilterom 5,5 HP / pump with prefilter 5,5 HP	1.681,50 €
1090172	Pumpa Aurora sa prefilterom 7,5 HP / pump with prefilter 7,5 HP	3.031,50 €
1090173	Pumpa Aurora sa prefilterom 10 HP / pump with prefilter 10 HP	3.447,60 €
1090174	Pumpa Aurora sa prefilterom 12,5 HP / pump with prefilter 12,5 HP	4.462,90 €
PUMPE AURORA BEZ PREFILTERA / PUMP AURORA WITHOUT PREFILTER		
1090175	Pumpa Aurora bez prefiltera 4 HP / pump without prefilter 4 HP	1.964,00 €
1090176	PumpaAurorabezprefilterom5,5HP/pumpwithoutprefilter5,5HP	2.094,30 €
1090177	PumpaAurorabezprefilterom7,5HP/pumpwithoutprefilter7,5HP	2.744,50 €
1090178	Pumpa Aurora bez prefiltera 10 HP / pump without prefilter 10 HP	3.103,20 €
1090179	PumpaAurorabezprefilterom12,5HP/pumpwithoutprefilter12,5HP	4.118,50 €

AURORAMODELLI3HP,4HPE5,5HPSA PREFILTER
AURORA MODEL 3HP, 4HP AND 5,5 HP WITH PREFILTER

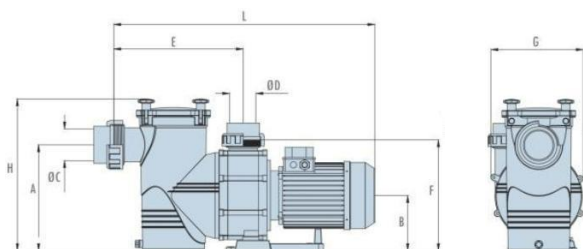

Mod.	A mm	B mm	C mm	D mm	E mm	F mm	G mm	H mm	L mm
3	300	160	Ø90	Ø75	368	320	264	431	713
4	300	160	Ø90	Ø75	368	320	264	431	743
5,5	300	160	Ø90	Ø75	368	320	264	431	743

Model	Snaga HP	Snaga kW	A 3 ~		H mm	Q m³/h
			230 V 50Hz	400 V 50Hz		
3	3	2,2	8,0	4,8	12	30
4	4	2,9	12,6	7,3	12	43
5,5	5,5	4	14,9	8,6	12	55

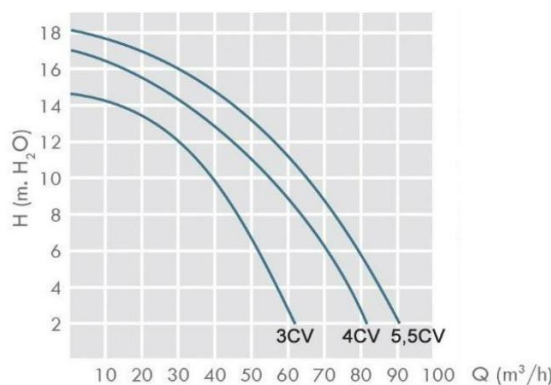

PUMPE

AURORA MODELLI 7,5 - 10-12,5 HP SA PREDFLITER AURORA MODEL 7,5 - 10 - 12,5 HP WITH PREFILTER

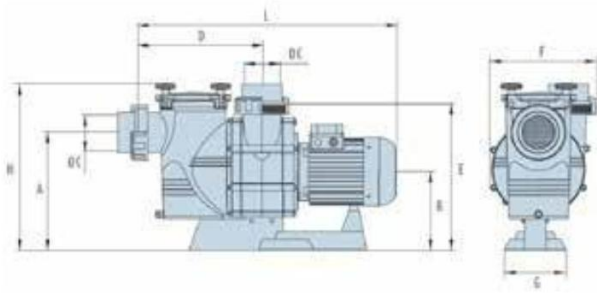

A mm	B mm	C mm	D mm	E mm	F mm	G mm	H mm
375	255	110	405	470	330	200	534

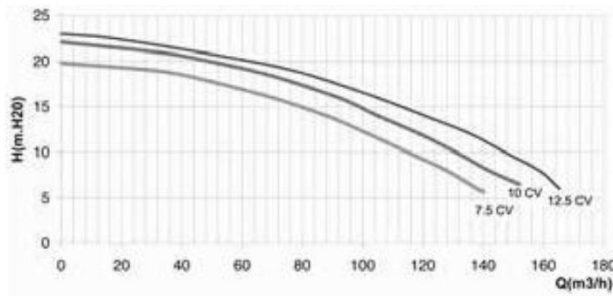

Modello	Potenza HP	Potenza kW	A 3 ~		H mm	Q m ³ /h
			230 V 50Hz	400 V 50Hz		
7,5	7,5	5,5	22,5	13,3	12	110
10	10	7,4	30,5	17,6	12	125
12,5	12,5	9,2	40	23,3	12	140

AURORAMODELLI BEZPREDFLITERA AURORA MODEL WITHOUT PREFILTER

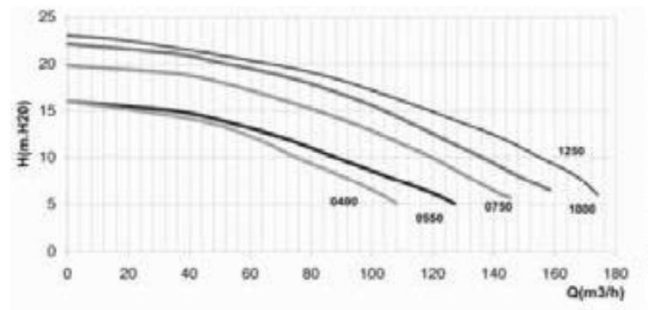
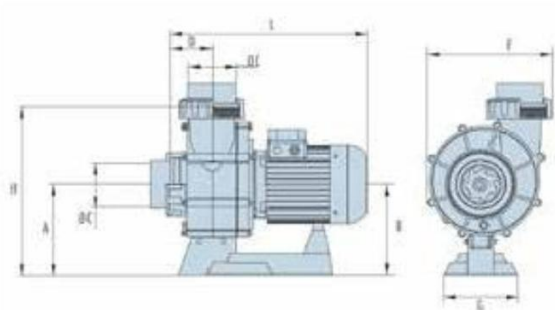

Model	A mm	B mm	C mm	D mm	F mm	G mm	H mm	L mm
4	255	255	90	105	330	200	470	510
5,5/7,5	255	255	110	105	330	200	470	530
10	255	255	110	105	330	200	470	600
12,5	255	255	110	105	330	200	470	645

Model	Snaga HP	Snaga kW	A 3 ~		H mm	Q m ³ /h
			230 V - 50Hz	400 V - 50Hz		
4	4	2,9	13,2	7,6	12	61
5,5	5,5	4	17,9	10,3	12	66
7,5	7,5	5,5	13,3	7,6	12	103
10	10	7,4	17,6	9,5	12	122
12,5	12,5	9,2	23,3	12,1	12	142

**SERIJE
RIVER**



Centrifugalne pumpe Vienna e River sa prefilterom, za cirkulaciju vode u uređajima za filtraciju bazena.

Materiali serije River

Telo pumpe, prefilter, difuzor, poklopac pumpe, poklopac konekcija, filter i rotor od PPO. Vratilo od čelika inox AISI 304

- Mehanička zaptivka sic-sic

Motor

- Asinhroni, dva pola.
- Zaštita IP55.
- Izolacija klase F
- Kontinuirani rad

Vienna and River centrifugal pumps complete with prefilter, for circulation in swimming pools.

Materials River serie

- Pump body, prefilter, diffuser, pump cover, connection cover, filter and impeller in PPO.
- Shaft in stainless steel AISI 304.
- Mechanical seal insic-sic

Motor

- Asynchronous, two poles.
- IP 55 protection.
- Class F insulation.
- Continuous operation

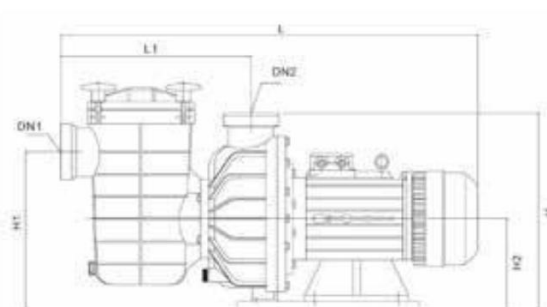
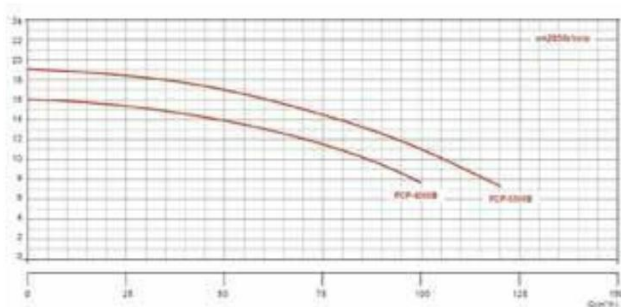

Model	L mm	L1 mm	H mm	H1 mm	H2 mm	DN1 mm	DN2 mm
River FCP-4000B	841	420	418	266	166	ø110	ø110
River FCP-5500B	886	420	418	266	166	ø110	ø110

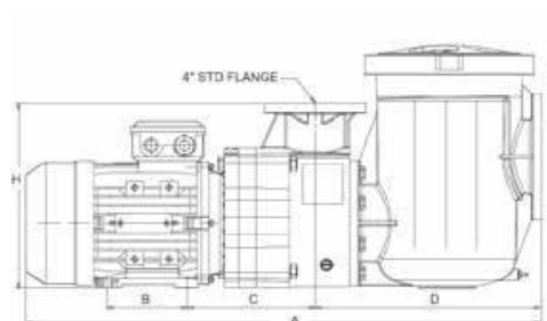
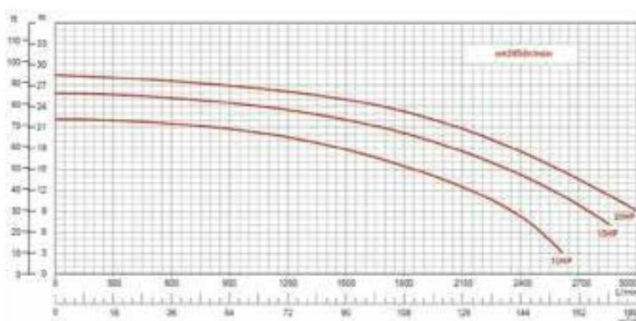

Model	A mm	B mm	C mm	D mm	F mm	G mm	H mm	H ₁ mm	H ₂ mm	K mm
River FCP-10AN	1145	140	298	508	483	216	415	295	546	12
River FCP-15AN	1330	210	305	508	483	216	415	295	546	12
River FCP-20AN	1330	210	305	508	483	216	415	295	546	12

Šifra	Model	Snaga HP	Snaga Kw	H m	Q m ³ /h	H m	Q m ³ /h	V 3 ~ 50	A 400 V	Cena
2220275	Vienna 400S*	4	3	8	54	12	43,5	400	6.4	703,00 €
1090141	River FCP-4000B	5,5	4	8	95	12	70	400	8.3	1.760,10 €
1090142	River FCP-5500B	7,5	5,5	8	115	12	95	400	11.1	1.859,10 €
1090143	River FCP-10AN	10	7,5	8	144	12	128	400	14.9	2.656,70 €
1090144	River FCP-15AN	15	11	8	175	12	155	400	21	3.171,30 €
1090145	River FCP-20AN	20	15	9	180	12	168	400	28	3.438,70 €

*Za model Vienna 400S vidi. str 135 / *For the Vienna 400S model look at page 1

PUMPE SERIJE LIVENO GVOŽĐE NM / CAST IRON NM PUMPS



Pumpa od livenog gvožđa sa zaptivkom od specijalnog uglja impregniranim u smolu/keramika/FPM za hlorisanu vodu.

Cast iron with special carbon sealing resin/ceramic/FPM impregnated for chlorinated water.

Impieghi

- Za čiste tečnosti bez abrazivnih čestica, ne agresivnih za materijale pumpe (sa tvrdim česticama do 0,2% max)
- Za snabdevanje vodom
- Za ugradnju za građanstvo i industriju

Uses

- For clean liquids without abrasives, which are non-aggressive for the pump materials (solids content up to 0,2%)
- For water supply
- For civil and industrial applications.

Motor

- Indukcioni dvopolni motor, 50Hz

Motor

- 2-pole induction motor, 50 Hz (n ≈ 2900 rpm)
- Three-phase 230/400V ± 10% upto 3

(n ≈ 2900 1/min)

- Trofazni 230/400V ± 10%, do 3kW;
- 400/690 V ± 10%, da 4 a 75 kW

kW; 400/690 V ± 10% from 4 to 75 kW
Insulation class F. Protection IP54
Liquid temperature from -10 °C to +90 °C.

- Izolacija klasa F. Zaštita IP54
- Temperatura tečnosti do -10°C a +90
- Temperatura ambijenta do 40°C
- visina manometričkog usisa do 7 m
- Krajni maksimalni dozvoljeni pritisak tela pumpe: 10 bar

- Ambient temperature up to 40° C.
- Total suction lift up to 7 m.
- Maximum permissible working pressure up to 10 bar

Šifra/code	Opis/description	Cena/price
1090130	Pumpa od livenog gvožđa bez predfiltera NM40/12A/C tri/pump without prefilter NM40/12A/C	1.234,40 €
1090131	Pumpa od livenog gvožđa bez predfiltera NM40/16B/B tri/pump without prefilter NM40/16B/B	1.513,90 €
1090132	Pumpa od livenog gvožđa bez predfiltera NM40/20C/B tri/pump without prefilter NM40/20C/B	1.868,70 €
1090133	Pumpa od livenog gvožđa bez predfiltera NM40/20AR/A tri/pump without prefilter NM40/20AR/A	2.543,00 €

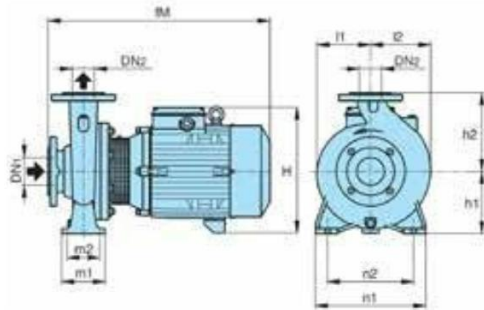

Model	DN1 mm	DN2 mm	f m	h1 mm	h2 mm	H mm	m1 mm	m2 mm	n1 mm	n2 mm	I1 mm	I2 mm
40/12A/B	65	40	450	112	140	240	100	70	210	160	100	113
40/16B/B	65	40	475	132	160	270	100	70	240	190	119	119
40/20C/A	65	40	495	160	180	298	100	70	265	212	140	140
40/20AR/A	65	40	525	160	180	320	100	70	265	212	140	140

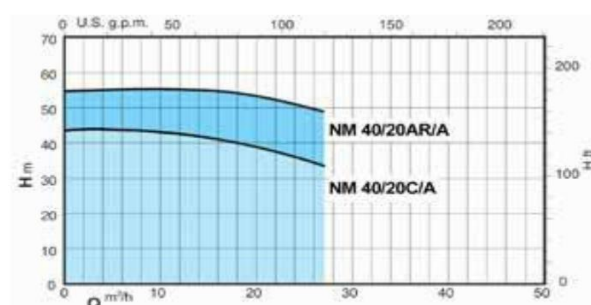
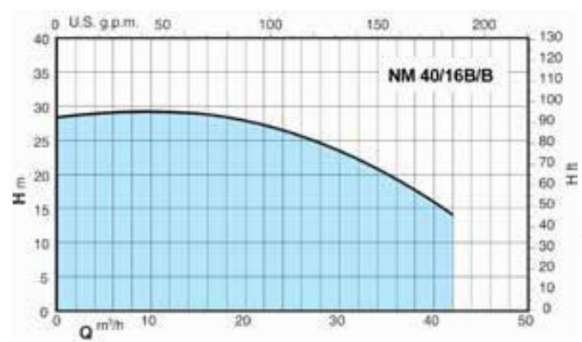
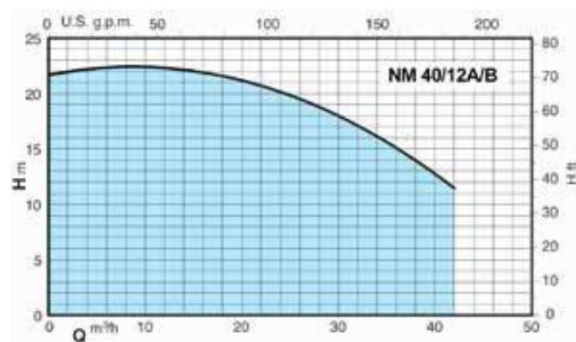

cpa-piscine.it

Model	Potenza kW	Potenza HP	230 V Δ 400 V Y		H m	Q m³/h
40/12A/B	2,2	3	9,2	5,3	-	13,0
40/16B/B	3	4	11,5	6,6	-	14,0
40/20C/A	4	5,5	-	9,6	5,5	33,5
40/20AR/A	5,5	7,5	-	10,8	6,2	49,0

PUMPE SERIJE LIVENO GVOŽĐE NM4 / CAST IRON NM4 PUMPS



Pumpa od livenog gvožđa sa zaptivkom od specijalnog uglja impregniranog u smoli/keramika/ FPM za hlorisanu vodu.

Upotreba

- Za čiste tečnosti bez abrazivnih čestica, ne agresivnih za materijale pumpe (satvrđim česticama do 0,2% max)
- Za snabdevanje vodom
- Kada se traži rad sa smanjenom bukom

Motor

- Indukovani motor 4 polni, 50 Hz (n ≈ 1450 1/min)
- Trofazni 230/400V ± 10%, do 3kW; 400/690 V ± 10%, da 4 a 75 kW
- Izolacija klase F. Protezione IP 54
- Temperaturatečn.: da -10 °C a +90 °C
- Temperatura okoline fino a 40 °C
- Visina manometr.usisa do 7m
- Pritisak final max dozvoljen u telu pumpe: 10bar

Cast iron with special carbon sealing resin/ ceramic/FPM impregnated forchlorinated water.

Uses

- For clean liquids without abrasives, which are non-aggressive for the pump materials (solids content up to 0,2%)
- For watersupply
- When low noise operating is required

Motor

- 2-pole induction motor, 50 Hz (n ≈ 2900 rpm)
- Three-phase 230/400 V ± 10% up to 3 kW; 400/690 V ± 10% from 4 to 75 kW
- Insulation class F. Protection IP 54
- Liquid temperature from -10 °C to +90 °C.
- Ambient temperature up to 40 °C.
- Total suction lift up to 7 m.
- Maximum permissible working pressure up to 10 bar

Šifra/ code	Opis/description	cena/ price
1090134	Pumpa od livenog gvožđa bez predfiltera NM440/25B/C tri / pump without prefilter NM440/25B/C	2.554,10 €
1090135	Pumpa od livenog gvožđa bez predfiltera NM440/25A/B tri / pump without prefilter NM440/25A/B	2.703,00 €
1090136	Pumpa od livenog gvožđa bez predfiltera NM4 65/25B/B tri / pump without prefilter NM4 65/25B/B	3.265,00 €
1090137	Pumpa od livenog gvožđa bez predfiltera NM465/31C/B tri / pump without prefilter NM465/31C/B	5.948,00 €
1090138	Pumpa od livenog gvožđa bez predfiltera NM480/25A/B tri / pump without prefilter NM480/25A/B	5.574,40 €
1090139	Pumpa od livenog gvožđa bez predfiltera NM480/31C/B tri / pump without prefilter NM480/31C/B	7.119,40 €

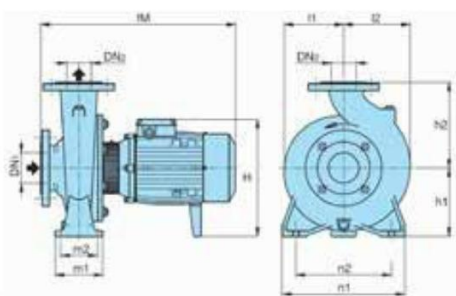

Model	DN1 mm	DN2 mm	fM mm	h1 mm	h2 mm	H mm	m1 mm	m2 mm	n1 mm	n2 mm	I1 mm	I2 mm
40/25B/B	65	40	495	180	225	308	125	95	320	250	175	175
40/25A/B	65	40	525	180	225	340	125	95	320	250	175	175
65/25B/A	80	65	540	200	250	360	160	120	360	280	175	190
65/31C/B	80	65	670	225	280	410	160	120	400	315	220	220
80/25A/B	100	80	745	200	280	385	160	120	400	315	191	210
80/31C/B	100	80	745	250	315	435	160	120	400	315	220	232

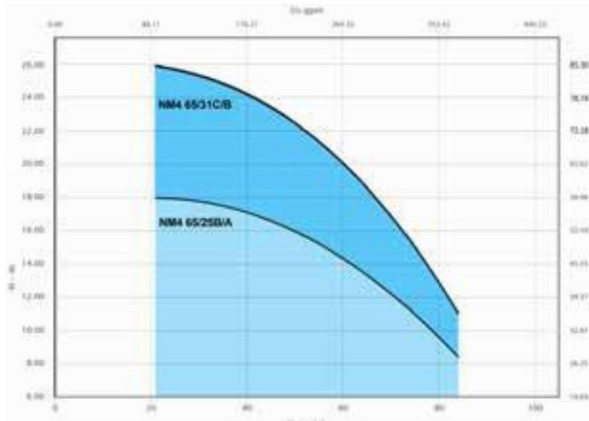
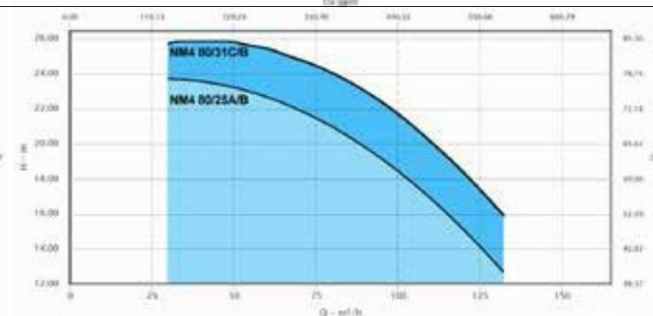
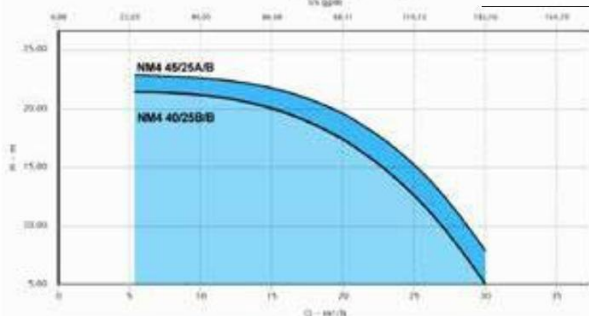

Model	Snaga kW	Snaga HP	230 V Δ 400 V Y			H m	Q m³/h
			400 V Δ		690 V Y		
			In A	In A	In A		
40/25B/B	2,2	3	8,6	5,0	-	10,0	27
40/25A/B	3	4	11,1	6,4	-	12,6	27
65/25B/A	4	5,5	-	8,3	4,8	13,1	66
65/31C/B	5,5	7,5	-	12,5	7,2	15,0	75
80/25A/B	7,5	10	-	16,0	9,2	15,1	120
80/31C/B	9,2	12,5	-	19,0	11,0	18,3	120

PUMPE

PREFILTERI ZA GRUBU OBRADU IN POLIPROPILENE E POLIFENILENOSSIDO POLYPROPYLENE AND POLYPHENYLENEOXIDE PREFILTERS

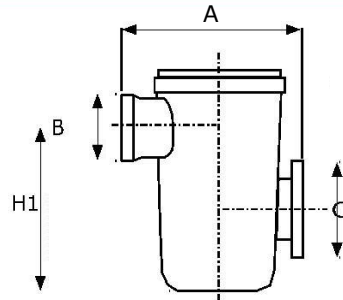

cod.1090295

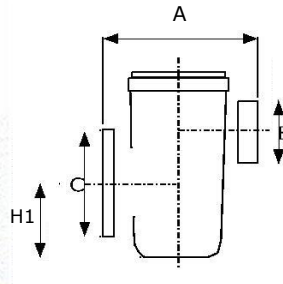

cod.1090293

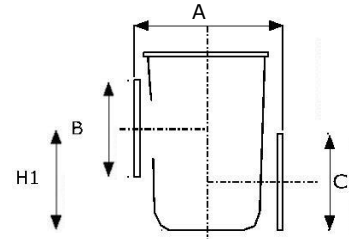

cod.1090292

Šifra/ code	Opis/description	cena/ price
1090295	Predfilter za grubu obradu od polipropilena za FCP 2200A/3000A/ 4000A-spoj Ø 75/DN 80/ Polypropylene roughing prefilter for FCP2200A/3000A/ 4000A - connection Ø 75/DN 80	196,50 €
1090293	Predfilter za grubu obradu od polipropilena za FCP-B-spoj Ø 110/DN 100 Polyprop. roughing prefilter for FCP-B-connection Ø 110/DN 100	226,40 €
1090292	Predfilter za grubu obradu od polifenilenoksida za FCP4.0A/7.0A/ 10A/15A - spoj 6"/DN 150/ Polyphenyleneoxide roughing prefilter for FCP 4.0A/7.0A/10A/15A-connection 6"/DN 150	944,00 €

Šifra	A [mm]	H1 [mm]	B [mm]	Flangia [mm]	C [m m]	Flanša [mm]
1090295	145	238	Ø75	--	DN 80	Ø90
1090293	309	150	Ø110	--	DN 100	Ø110
1090292	427	295	DN 130	Ø160	DN 150	Ø160

RAZVODNE KUTIJE

PREFILTERI ZA GRUBU OBRADU ČELIK INOX STAINLESS



Prefilterisa korpicom na vađenje od čelika INOX 316, telo kompletno napravljeno od čelika INOX 304. Podobni kako za usis pumpi (zaštita turbine) tako za filtraciju za razne instalacije. Slobodne flanše u PVC.

Prefilters with 316 stainless steel removable bowl, body entirely made of stainless steel 304. Suitable for the suction of the pumps (protection turbine) and for the filtration for different installations. PVC free flanges.

Šifra / code	Opis / description	cena / price
1090190	Prefilter PFP čelik inox AISI 304 DN-100 / prefilter in stainless steel	4.176,00 €
1090191	Prefilter PFP čelik inox AISI 304 DN-125 / prefilter in stainless steel	4.304,00 €
1090192	Prefilter PFP čelik inox AISI 304 DN-150 / prefilter in stainless steel	5.562,00 €
1090193	Prefilter PFP čelik inox AISI 304 DN-200 / prefilter in stainless steel	6.195,00 €
1090194	Prefilter PFP čelik inox AISI 304 DN-250 / prefilter in stainless steel	7.100,00 €

RAZVODNA KUTIJA POOL CONTROL ELETRIC PANEL POOL CONTROL



KUTIJA KOMPLETNA SA: metalnom kutijom (norma IP55) sa sigurnosnom bravicom ili sandučad od plastike (IP65), sat programator za svaku pumpu, prekidač ON/OFF, set plovaka za kompenzacioni rezervoar, nosač komandne kutije reflektora, priključni kablovi ožičeni sa terminalnim blokom, certifikat o saobraznosti i sigurnosti po normama CEE, šema za povezivanje.

Panel full of: metal enclosure (IP55) with security lock door or plastic boxes (IP65) timer for each pump, switch ON/OFF, set floating overflow tank, connection for control lights, wired to terminal connections, certificate of compliance and security under the CEE wiring diagram.

Šifra / code	Opis / description	cena / price
3 HP		
1091020	Razvodna kutija Pool Control za 3 pumpe	2.678,00 €
1091030	Razvodna kutija Pool Control za 4 pumpe	4.194,00 €
1091040	Razvodna kutija Pool Control za 5 pumpi	4.615,00 €
4 HP		
1091021	Razvodna kutija Pool Control za 3 pumpe	2.693,00 €
1091031	Razvodna kutija Pool Control za 4 pumpe	4.194,00 €
1091041	Razvodna kutija Pool Control za 5 pumpi	4.615,00 €
5,5 HP		
1091022	Razvodna kutija Pool Control za 3 pumpe	2.750,00 €
1091032	Razvodna kutija Pool Control za 4 pumpe	4.241,00 €
1091042	Razvodna kutija Pool Control za 5 pumpi	4.982,00 €
7,5 HP		
1091023	Razvodna kutija Pool Control za 3 pumpe	4.244,00 €
1091033	Razvodna kutija Pool Control ZA 4 pumpe	4.752,00 €
1091043	Razvodna kutija Pool Control per 5 pumpi	5.198,00 €
10 HP		
1091024	Razvodna kutija Pool Control za 3 pumpe	4.298,00 €
1091034	Razvodna kutija Pool Control za 4 pumpe	4.806,00 €
1091044	Razvodna kutija Pool Control za 5 pumpi	5.198,00 €

RAZVODNA KUTIJA + UTIČNICE REFLEKTORA + KOMPENZACIONI PLOVCI
CONTROL PANEL + PLUG LIGHTS + FLOATING HAND

**PODNE MLAZNICE ABS ZALAJNER
ABS BOTTOM INLET FOR LINER**

Šifra/ code	Opis/description	Cena/ price
1070071	Mlaznica sa rešetkom, aspirazione/mandata 2" diam. 63 a incollaggio, liner-C-319 / Bonding inlet with grid 2" Ø63	27,30 €
2220501	Bocchetta a pavimento incollaggio con griglia diam.63, liner / Floor inlet glue with grid diam 63, liner	42,90 €
2220106	Bocchetta a pavimento diam. interno 50, esterno 2", flange liner rif. 96825V / Floor inlet diam. internal 50, external 2"	23,00 €



cod.1070071



cod.2220501



cod.2220106

**PODNI SLIVNICI VELIKOG PROTOKA ZA LAJNER PO NORMI UNI EN 13451-3
BIG RANGE MAIN DRAIN FOR LINER IN ACCORDANCE WITH THE STANDARD UNI 13451-3**

Telo od poliestera ojačano fibreglasom. rešetka od čelika inox AISI 316. Izlaz PVC za lepljenje.
Body in fiberglass reinforced polyester. AISI 316 stainless steel grid. Bonding output of PVC.



cod.1071036



cod.1071037



cod.1071013



cod.1070381

Šifra/code	Opis/description	cena/price
1071036	Podni slivnik za lajner 330 x 330 Ø 110, rešetka inox AISI 316, po normi UNI EN 13451-3 main drain for liner, grid in stainless steel AISI 316, in accordance with the standard UNI 13451-3	2.205,00 €
1071037	Podni slivnik za lajner 512 x 512 Ø 200, rešetka inox AISI 316, po normi UNI EN 13451-3 main drain for liner, grid in stainless steel AISI 316, in accordance with the standard UNI 13451-3	2.973,00 €
1071013	Podni slivnik PVC za lajner spoj Ø90 (3"), po normi UNI EN 13451-3 main drain in PVC for liner Ø90 (3"), in accordance with the standard UNI 13451-3	496,20 €
1070381	Podni slivnik za lajner 735 x 735 Ø 200, rešetke inox AISI 316, po normi UNI EN 13451-3 main drain for liner 735 x 735 Ø 200, AISI 316 stainless steel grid, in accordance with UNI EN 13451-3	3.600,00 €

**ZIDNA REŠETKA I SET NOSAČA REŠETKE
WALL GRILL AND GRID SUPPORT KIT**

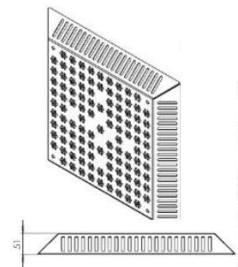
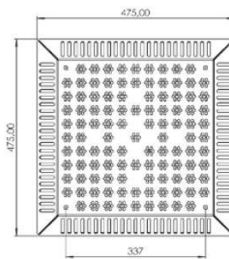
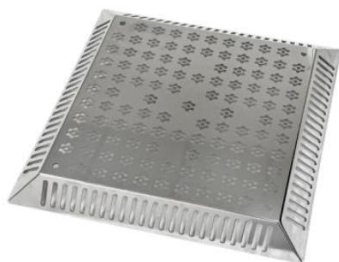

Šifra/code	Opis/description	Cena/price
1020040	Zidna rešetka	900,00 €
1020041	Set nosača rešetke	150,00 €

Prisustvo soli u vodi povećava provodljivost iste povećavajući akciju mogućih lutajućih struja prisutnih u bazenu. Pravilna instalacija bazena predviđa ukupavanje strukture i, ako prisutna, centrale elektrolize. Ovi fenomeni se ne mogu ponekada predvideti a posledice (oksidacija / korozija) nisu isključivo prouzrokovane navodnom lošom proizvodnjom proizvoda ili materijala.

ISTRUMENTI

MERAČI PROTOKA PITOT/ PITOT FLOWMETERS

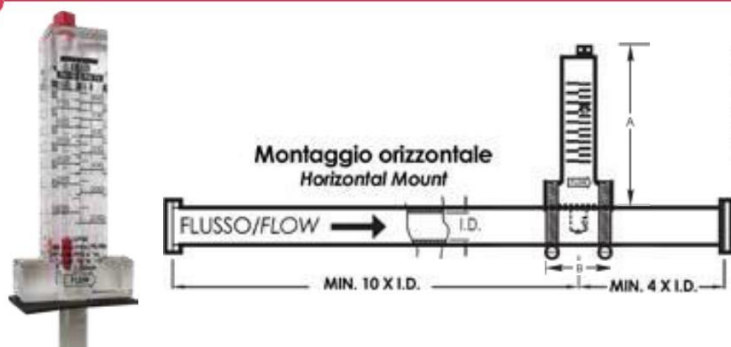

- Merači protoka za cevi od Ø63 do Ø200 mm
- Rang protoka da 100 a 5100 LPM
- Telo od akrila
- Moguća instalacija na postojećim cevima, bez potrebe za adapterima
- Uključene flanše i dihtunzi
- Flowmeters for Ø63 to Ø200 mm pipes
- Flow rates from 100 to 5100 LPM
- One piece machined acrylic body
- Mount to existing pipe. No unions or adapters required
- Mounting clamps and gasket included

Šifra/ code	Opis/description	Dimenzije/ Dimensions [mm] A	Dimenzije/ Dimensions [mm] B	Range LPM	Cena/ price
1041300	Merači protoka za cev Ø50 / flow-meter for pipe Ø63	110	62	50 - 350	271,70 €
1041301	Merači protoka za cev Ø63 / flow-meter for pipe Ø63	110	62	100 - 475	292,00 €
1041302	Merači protoka za cev Ø75 / flow-meter for pipe Ø63	110	62	150 - 700	333,30 €
1041303	Merači protoka za cev Ø90 / flow-meter for pipe Ø90	110	62	200 - 850	375,70 €
1041304	Merači protoka za cev Ø110 / flow-meter for pipe Ø110	110	62	600 - 1800	409,80 €
1041305	Merači protoka za cev Ø160 / flow-meter for pipe Ø160	108	62	900 - 3200	662,50 €
1041308	Merači protoka za cev Ø200 / flow-meter for pipe Ø200	108	62	1500 - 5100	736,80 €

PALETNI MERAČI PROTOKA DIGITALNI / PADDLEWHEEL FLOWMETERS

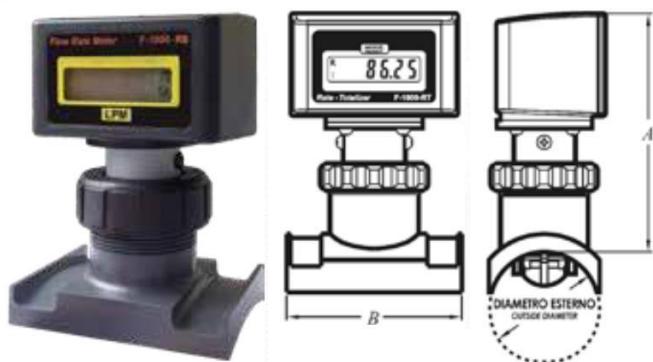

Instalacija / Installation
INPUT 10 x I.D. - OUTPUT 5 X I.D.

- Horizontalna instalacija sa sedlo montažom
- Display LCD 6 cifre e fino a 4 posizioni decimali con aggiornamento dati ogni 1,5 sec. Con calibrazioni di fabbrica
- A prova dimanomissione
- Funzionamento a batteria (2 batterie AAA incluse)
- CustodiainABSresistenteagliagentiatmosferici.Noninstallare il display LCD sotto luce solare diretta
- Horizontal saddle mount installation
- 6digitdisplay,upto4decimalpositions.Displayupdate time: rate 1,5sec. Factorycalibrated
- Tamper proof
- Battery operated (2 AAA batteries included)
- Weather resistant ABSenclosure. LCD is not recommended for direct sunlight applications

Šifra/ code	Opis/description	Cevovod [mm]	Dimenzije [mm]		Range LPM	cena/ price al pz
			A	B		
1041311	Digitalni merač protoka / flow-meter	90	110	81	887	1.018,00 €
1041312	Digitalnimerlač protoka / flow-meter	110	110	81	992	1.139,00 €
1041313	Digitalni merač protoka / flow-meter	160	108	81	992	1.139,00 €
1041314	Digitalni merač protoka / flow-meter	200	108	81	992	1.139,00 €

MANOMETRI,SLAVINE ZA UZORKOVANJE I TERMOMETRI MANOMETER,FAUCETFORTAKENSAMPLESANDTHERMOMETERS

Šifra/ code	Opis/description	Cena/ price
1080216	Manometar 0-2,5 bars, 1/8" / Manometer 0-2,5 bars, 1/8"	20,70 €
600-00791	Manometar za filtere Mediterraneo / Manometer for Mediterraneo filters	23,80 €
1041329	Slavina za uzorkovanje 1/2" / Faucet for taken samples 1/2"	22,80 €
1041360	Prednji termometar priključak 1/2" 0/120°C / Frontal thermometer 1/2" 0/120°C	38,50 €



cod.1080216



cod.1041329



cod.1041360

TUNELSKI TUŠ SA FOTOČELIJSKIM STUBOM TUNNELSHOWERWITHCOLUMNPHOTOCELL

Proizvedni od čelika inox AISI-304. Osmišljeni za pristup javnim bazenima. Širina 1,20 m., Maksimalna visina 2,50 m. Automatizam aktiviranja putem fotočelijskog stuba. Prolazni bočni stubići od plastike.

Made of stainless steel AISI-304. Designed for access to public swimming pools. Width 1.20m. Maximum height 2.50m. System of operation of the column by an automatic photocell. Bollard side passage in plastic.

Šifra/ code	Opis/description	cena/ price
1041242	Tunelski tuš 1 luk sa 3 glave tuša čelikinix AISI 304 Tunnel 1 arc, 3 shower	1.048,00 €
1041247	Stub inox sa fotočelijama za tunelski tuš Column with a photocell for shower	1.334,30 €
1041248	Kutija sa fotočelijama Panel with a photocell	437,30 €

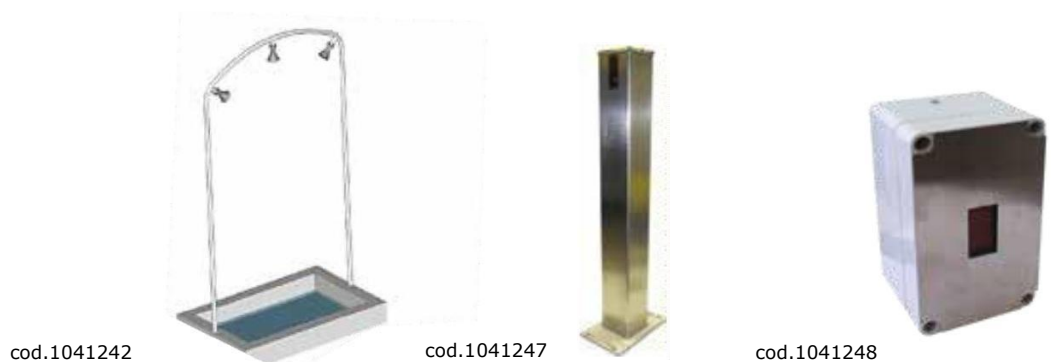

PLOČA ZA OKRET/ TURNING PLATE



Struktura od čelika inox 316, širina m 2,5 o 2 m. Dostupna sa dva nosača, podesivi po udaljenosti od vode prema položaju baze za fiksiranje i sa dizajnom protiv povreda. Korišćeni materijali i proizvodnja su italijanskog porekla. Svi proizvodi poštuju normative F.I.N.A.

Stainless steel 316 structure, width 2.5m or 2. Available in two supports, adjustable in the distance from the water in accordance with the position of the fixing base and with anti-accident design. The material used and the production are of Italian origin. All products comply with F.I.N.A. rules.

Šifra/ code	opis/description	Cena/price al pz
1041228	Ploča za okret sa 2 nosača mm.2000/Turning plate with 2 supports mm.2000pz.	2.576,90 €
1041229	Ploča za okret sa 2 nosača mm.2500/Turning plate with 2 supports mm.2500pz.	2.694,00 €

REŠETKE ZA IVICE I OBLOGE / EDGE AND COVER GRIDS

Uzdužna rešetka od ABS stabilizovana na UV zrake, sa 6 čeličnih inox cevi. Mera modula cm.50. Po normi FINA

Longitudinal grid in UV stabilized ABS complete with n.6 stainless steel tubes. Module size cm.50. Comply with FINA rules



cm

Šifra/ code	Opis/description	cena/price mt
1041111	Rešetka debljine cm 3 cm 24,7 Rešetka debljine 3 cm 24,7	124,60 €
1041112	Rešetka deblj. cm 3 cm 29,8 Rešetka deblj. 3 cm 29,8 cm	148,10 €

INDIKATORI TAKMIČENJA / NOTICE INDICATORS

Šifra/ code	Opis/description	Cena/ price pz
1041101	Bazenski brojači od čelika inox i forex / Count tanks, stainless steel and forex	747,00 €
1041218	Linija lopti za lažni start / Balls online false start	30,30 €
1041102	Linija zastavica ledno okretanje 22 metara / Flags line turn back 22 meters	475,70 €
1041108	Linija zastavica ledno okretanje 30 metara / Flags line turn back 30 meters	648,70 €
1041103	Par čeličnih inox indikatorskih stubova za takmičenj preč. 45/48 / Pair of race signposts steel / stainless steel diam. 45/48	502,60 €



cod.1041101



cod.1041218



cod.1041102



cod.1041103

PLUTAJUĆE PLIVAČKE TRAKE / LANES

Plutajuća traka štampana, od polietilena, tretirana specijalnim aditivima protiv kiseline i protiv UV zraka. Unutar svake trake ubačena su dva plovka koji optimiziraju plutanje. Isporučuju se kompletne sa oprugama zaštita užeta i zatežaćima čeličnim inox AISI 316 (od 25m i više). Na raspolaganju dva prečnika 110 e 150i u sledećim bojama: belo, plavo, žuto, crno, crveno, zeleno.

Printed lane frangionda, in polyethylene, treated with special additives, anti acid and anti UV. Within each frangionda two floats are inserted to optimize the flotation. Delivered complete with spring save-cable and tensioner lane in stainless steel AISI 316 (from m 25). Available in two Ø 110 and 150 and in the following colors: white, blue, yellow, black, red, green.

Šifra/ code	Opis/description	Cena/ price
1041200	Plutajuća traka Ø110 kompletna sa oprugom i zatezačem, al m (od m 25 i više) Breakwater lane Ø 110 complete of spring and tend lane, m. (from 25 m and over)	62,30€
1041201	Plutajuća traka Ø150 kompletna sa oprugom i zatezačem, / m (od m 25 i više) Breakwater lane Ø 150 complete of spring and tend lane m. (from 25 m and over)	72,00€
1041109	Plutajuća traka Ø110 mt. 25 komplet Breakwater lane Ø 110 m. 25 komplet	1.560,90 €
1041110	Plutajuća traka Ø150 mt. 25 komplet Breakwater lane Ø 150 m. 25 complete	1.805,50 €

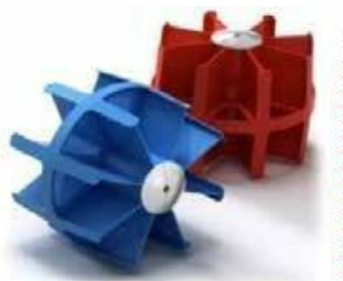

OPREMA

KOLICA ZA NAMOTAVANJE TRAKA I OPREMA / CART FOR LANES AND ACCESSORIES

Kolica za namotavanje trake: struktura od čelika inox AISI 304 i plastični laminat HPL, montirana na okretnim točkovima čelika inox sa gumom, nosivost 5 traka od 25 m, prečnika 110 mm. Dimenzija: širina 120 x dužina 190 x visina 135.

Cart winding lanes: stainless steel AISI 304 and HPL laminate, mounted on rubber castors in stainless steel, range 5 lanes 25 m, 110 mm diameter. Dimensions: length 190 x width 120 x height 135.

Šifra/ code	Opis/description	cena/ price
1041202	Kolica za namotavanje traka / Cart for lanes	3.936,00€
Oprema/ ACCESSORIES		

1041207	Kalemski zatezač trake inox AISI 316 – uključujući zatezač prekrivke od polipropilena Lane tender with spool steel AISI 316- including cover tensioner polypropylen	275,20 €
1041258	Zatezač prekrivke od silikonske gume / Tensioner cover silicone rubber	16,60 €
1041219	Zatezač sa pričvršćivačem čelik inox AISI 316 / Turnbuckle tie rod stainless steel AISI 316	137,60 €
1041208	Opruga za uštedu užeta od čelika inox AISI 316 / Spring saves cable in stainless steel AISI 316	70,80 €
1041209	Kablo-uže od čelika inox AISI 316 al m / Cable-wire stainless steel AISI 316	7,60 €
1041212	Zatezač čelični inox AISI 316 / Turnbuckle stainless steel AISI 316	80,50 €

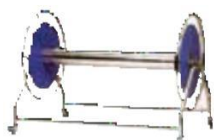

cod.1041202



cod.1041207



cod.1041258



cod.1041219



cod.1041208



cod.1041212

ANKERI ZA PLUTAJUĆE TRAKE / ANCHORS PER LANE

Šifra/ code	Opis/description	Cena/ price
1041204	Baza za fiksiranje čelik inox Ø45 mm / Fixed base stainless steel Ø45 mm	136,10 €
1041299	Baza za fiksiranje čelik inox nagnuta Ø45 mm / Fixed base stainless steel inclined Ø45 mm	153,90 €
1041206	Ankerisanje čelik inox stubić na vađenje / Anchor bolt removed	58,50 €
1041203	Zidno bar ankerisanje inox za liner / Stainless steel anchor to a wall bar for liner	145,30 €
1041297	Zidno bar ankerisanje inox / Stainless steel anchor to a wall bar	106,90 €
1041298	Zidno ankerisanje čelik inox sa skrivenom kukom / Anchor stainless steel hook hidden in the wall	127,70 €



cod.1041204



cod.1041206



cod.1041203



cod.1041297



cod.1041298

OPREMA

STARTNI BLOKOVI / STARTING BLOCKS



Konstrukcija Inox AISI-304. Protivklizna platforma nagnuta od poliestera e od 500 mm x 500 mm. Bez numeracije.

AISI-304 stainless steel construction. Inclined anti-slip platform in polyester and 500 mm x 500 mm. Numbering not included.

Šifra/ code	Opis/description	Cena/ price
1041326	Startni blok H. 400 mm Startingblock h. 400 mm	1.580,00 €



Konstrukcija Inox AISI-304. Protivklizna platforma nagnuta od poliestera e od 500 mm x 500 mm. Bez numeracije.

AISI-304 stainless steel construction. Inclined anti-slip platform in polyester and 500 mm x 500 mm. Numbering not included.

Šifra/ code	Opis/description	Cena/ price
1041327	Startni blok H. 700 mm Startingblock h. 700 mm	2.248,00 €

STARTNI BLOKOVI / STARTING BLOCKS



cod.1041213



cod.1041215



cod.1041113



cod.1041119

Šifra/ code	Opis/description	Cena/ price
1041213	Startni blok mod. ROMA ALTO AISI 316 regolabile / Starting block mod HIGH	3.538,00 €
1041215	Startni blok mod. SIVIGLIA AISI 316 regolabile / Starting block mod SIVIGLIA	1.815,90 €
1041113	Startni blok mod. ROMA AISI 316 regolabile / Starting block mod. ROMA AISI 316 adjustable	2.695,90 €
1041119	Startni blok mod. ISIA AISI 316 verniciatoregolabile / Startingblock mod. ISIA AISI 316 paintedadjustable	2.022,60 €
1041227	Zadnja platforma startnog bloka AISI 316 / Rear platform for starting block	1.125,00 €

BOA ZA SPASAVANJE/LIFESAVER



BOA homologovana:

Urađena u polietilenu visoke gustine. Opremljena reflektirajućim trakama i užetom. Dimenzije Ø spolja 70 cm - Ø unutra 44 cm - težina 2,5 kg

Lifesaver:

Made of high density polyethylene. Equipped with reflective tapes and line. External dimensions Ø 70 cm - internal Ø 44 cm - weight 2,5 kg

Šifra/code	Opisdescription	Cena/price
1041295	Boa za spasavanje homologovana /Approved lifesaver	166,10 €

MOBILNI PODIJUM BAZENA / REMOVABLE HEAD

Struktura izrađena od čelika inox AISI 316 sa poliranjem površine na ogledalo u estetskim delovima. Pokrivena rešetkama i protivkliznim uglovima, proizvodi od ABS stabilizovan na UV zrake i tretiran protiv kiselina. Omogućava održivost preliivanja vode na sve 4 strane, kreirajući jednu površinu za hodanje od 30cm iznad površine vode kako predviđaju važeći normativi F.I.N.A., izbegevaajući i instalaciju ploča za okret.

Dozvoljava instalaciju plutajućih staza za plivanje i elektronskih ploča za merenje vremena kao i fiksiranje svakog startnog bloka ili skakaonice.

Potpuno prilagođene postavke u dimenzijama i bojama.

Svaki naš proizvod poštuje u potpunosti norme F.I.N.A. i sigurnosne standarde. Podsećamo da kompletna naša proizvodnja koristi obradu i varenja certifikovana propisima UNI EN ISO 3834-2.

Structure in AISI 316 stainless steel with mirror polishing in the aesthetic parts. Covered in grids and angular slip, products ABS UV stabilized and treated anti acid. It allows to maintain the overflow circulation of water on 4 sides, creating step plane 30 cm from the water as expected from FINA requirements, also avoiding the installation of the turn plates.

Allows installation of floating lanes and electronic timing plaques over which the fixing of each starting block or pad. Fully custom installations in all sizes and colors.

Every our product fully complies with the norm F.I.N.A. and the safety rules. We recall that all our production makes use of machining and welding certified according to UNI EN ISO 3834-2.

Šifra/ code	Opis/description	Cena/ price pz
1041107	Obložena pokretna pedanaabssupportoblocchicm101x106h.30+placcaviratafrontalel.cm249 Coatedremovablefootrest abs support blocks 101x106 cm h.30 + turn the front plate. 249 cm	3.635,80 €



VISOKA STOLICA ZA NADZOR / SURVEILLANCE HIGH CHAIR



Šifre/ code	Opis/description	Cena/ price pz
1041115	Pokretni model- cevna struktura od čelika inox 316 diam. mm. 45 i gazišta od copolimera Mobile model - 316 stainless steel tube structure diam. mm. 45 and copolymer steps Coatedremovablefootrestabssupportblocks101x106cmh.30+turnthefrontplate.249cm	4.876,00 €

FIZIOTERAPEUTSKI BAZENI

FIZIOTERAPEUTSKI BAZENI PHYSIOTHERAPY POOLS

Fizioterapeutske bazene za riedukaciju i funkcionalno prilagođavanje pacijenta. Istovremeno se mogu koristiti za vodene aktivnosti razne vrste: "Acquaticità Mamma - Bebè", "Aquabuilding", "Aquastretching", personalizovana gimnastika, Cardio- Training i rehabilitacija.

- Bazeni od čelične strukture duplog modularnog panela, sklopljeni za realizaciju dimenzija po izboru mušterija.
- Peščani kvarcni uređaj za filtraciju sa povratnim sistemom skimer. Mogućnost izbora sistema sanifikacije vode (sijalice UV-C, elektroliza, tečni kiseonik itd...)
- Adaptirani za banjske terapije, sa mogućnošću personalizovanja uređaja grejanja vode.
- Obloga sa sjajnim i mat finiturama, na raspolaganju više boja, jednostavnog održavanja.
- Maksimalna personalizacija vezano za hidromasažne tretmane i uređaji za podizanje pacijenata.

Physiotherapy pools for rehabilitation and retraining the patient's functional. They are also used for water activities of various kinds: "Waterskills Mom - Baby," "AQUABUILDING", "Aquastretching", custom gymnastics, cardio-training and rehabilitation.

- *Swimmingpools with amodular double panelsteelstructure, assembledto create tanks with dimensions at the customer's choice.*
- *Quartz sand filtration plant with recovery skimmer system. Choice in relation to water disinfection system (light UV-C, electrolysis, liquid oxygen etc.)*
- *Adapted for bathing, with the possibility of customization of the 'water heating system'.*
- *Liner with gloss and matt finishes, available in different colours, easy to maintain.*
- *Highest relative to customize massage treatments and patient lifting devices.*



**ELEKTRIČNO DIZALO
PACIJENATA PATIENTS**



cod.1041116



cod.1041117



cod.1041118

Šifra	Opis		Cena
1041116	Dizalo za invalide električno ekološko (potreban art. 1041117 ili 1041118) Ecoelectric wheelchair lift (art. 1041117 or 1041118 required)	pz	Na upit
1041117	Ploča za fiksiranje dizala od čelika inox/Fixing plate for lifter in stainless steel	pz	Na upit
1041118	Čaura za čelični inox dizala / Case for lifter in stainless steel	pz	Na upit

**HIDRAULIČNO DIZALO ZA
PACIJENTE
HYDRAULIC LIFTING PATIENTS**



Svestran, prilagodljiv većini bazena kako ukopanih tako i nadzemnih. Rad dizala se odvija bez struje koristeći obični pritisak vodene mreže i u uslovima slabijeg pritiska. Kompletan sa rukom i sedištem sa preklopnim rukohvatima, protivklizno sedište i sigurnosni pojas. Realizovan u aluminijumu, čelik INOX 316 i PVC, farbanje estetskih komponenti u epoksidnom materijalu, otporni na rđu. Minimalni pritisak rada 1,5bar. Nosivost maksimalna: 135Kg.

Versatile, it adapts to most in-ground and above-ground pools. The lift operates without electricity, using simple mains pressure even in low pressure conditions. Complete with folding arm and seat, non-slip seat and safety belts. Made of aluminium, 316 stainless steel and pvc, the paintwork of the aesthetic components is epoxy, free of rust. Minimum operating pressure 1.5 bar.

Šifra/ code	Opis/description	Cena/ price
600-22008	TUTOR900/TUTOR900hydrohoist	15.840,00€
600-22007	Ploča hidro dizanja TUTOR900/TUTOR900hydrolift plate	495,00 €

RIO GRANDE – SPORA PLOVNA REKA
RIO GRANDE - SLOW RIVER WATERWAY

Rio Grande je modularna struktura koja se može razviti u raznim pravcima. Moduli su urađeni od ojačanog fiberglasa i potpuno su proizvedeni u Italiji. Dva komponibilna modula radi kreiranja protoke vode po meri. Izazivati struju vode, doživljavajući jedan zabavni protok sav u krivinama i da se pređe u gumenim čamcima i šlaufima.

Rio Grande is a modular structure that can be developed in different paths. The modules are made of reinforced fiberglass and they are produced entirely in Italy. Two modular units to create the perfect water trails. Challenging the current of water and experience a fun path around curves on a rubber boats and rubber ring.

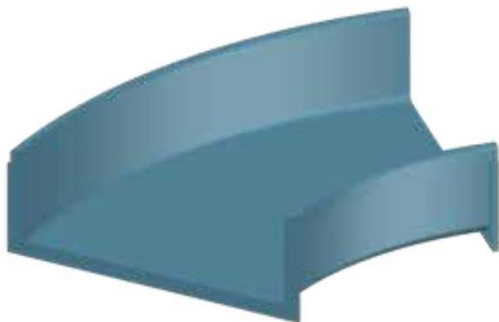

MODUL BAZE
BASE MODULE

+

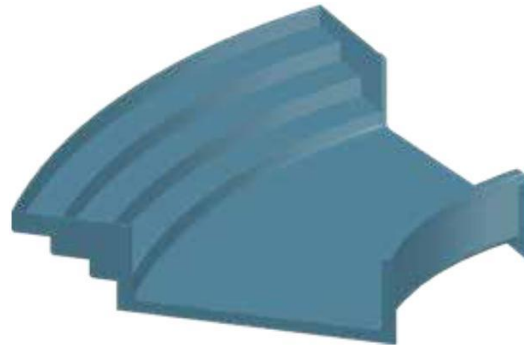

MODUL SA PRISTUPNIM STEPENIŠTEM
BASE MODULE WITH STAIR

NEKI OD MOGUĆIH PROLAZA:

RIO 37

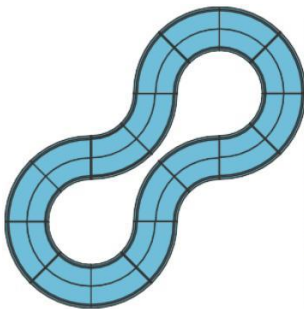

n° moduli BAZE n°	14
moduli stepenica	2
Razvoj	37 m

RIO 55

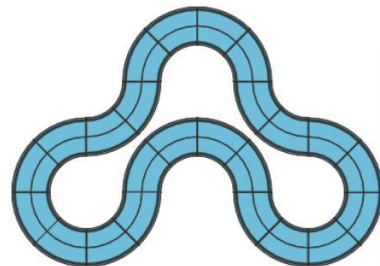

Br.modula BAZE	21
moduli stepenica	3
Razvoj	55 m

RIO 55

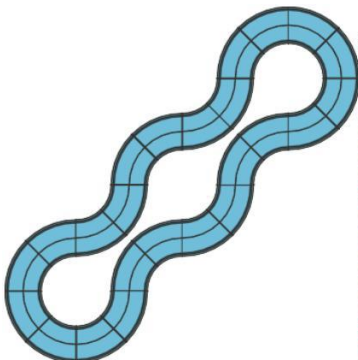

n° moduli BAZE	20
modul.stepenica	4
Razvoj	55 m

RIO92

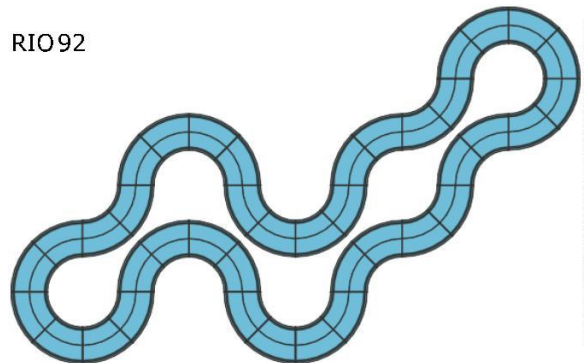

n° moduli BAZE	35
modul stepenica	5
Razvoj	92 m

VIŠE INFORMACIJA I CENE NA UPIT / FURTHER INFORMATION AND PRICES ON REQUEST



Accessories

OPREMA



7



SADRŽAJ

SOLARNI TUŠEVI / SOLAR SHOWERS

- 330 HAPPY FIVE E BIG HAPPY FIVE
- 331 JOLLY E BIG JOLLY
- 332 DADA
- 333 SPRING E ENERGY PRO
- 334 FUNNY YIN E FUNNY YANG
- 335 HAPPY GO E JOLLY GO

OPREMA/ ACCESSORIES

- 336 TUŠ ZA PLAŽU/ BEACH SHOWER
- 337 KADICE ZA PRANJE NOGU/ FEET WASHBASINS
- 338 TOBOGANI OD FIBERGLASA/ FIBERGLASS TOBOGGANGS
- 338 ZEMNE LEŽALJKE ILI PLUTAJUĆE/ SERENDIPITY FOR FLOOR OR FLOATING
- 339 SIGURNOSNA OPREMA/ SAFETY DEVICES

ČELIČNE STEPENICE I RUKOHVATI / STAINLESS STEEL LADDERS AND HANDRAILS

- 346 STEPENICE ELETROLISI / ELECTROLYSIS LADDERS

ŠKAKAONICE / SPRINGBOARDS DIVING

- 348 WINNER 160
- 349 ULISSE

MLAZEVI I VODOPADI / JETS AND FALLS

- 349 VODENI MLAZEVI / WATER BLADES
- 350 VODOPADI / WATER FALL
- 353 VODENI TOP/ WATER CANNON
- 354 ERCOLANO PEČURKA / ERCOLANO FUNGUS
- 354 SET ZA KOMPLETIRANJE MLAZEVA VODA I FONTANE / KIT FOR COMPLETE SYSTEM WATER JET AND FOUNTAINS
- 355 MLAŽNICA SA JEDNIM MLAZOM / SINGLE JET NOZZLE

FONTANE, SEDIŠTA I LEŽALJKE / FOUNTAIN, SEAT AND SUN LOUNGERS

- 356 FIZIOTERAPEUTSKO SEDIŠTE /PHYSIOTHERAPY CHAIR
- 357 LEŽALJKE OD ČELIKA INOX / APOLLO LOUNGER IN STAINLESS STEEL

HIDROMASAŽA / HYDROMASSAGE

- 358 ACQUA BUBBLE / WATER BUBBLE
- 358 SET PUMPA I DUVALJKI / PUMP AND BLOWERS KIT





HAPPY FIVE

KARAKTERISTIKE | Features

visina 2.17 m
 rezervoar 28 l
 zapremina vode
 težina 8 kg
 weight



BIG HAPPY FIVE

KARAKTERISTIKE | Features

visina 2.15 m
 rezervoar 40 l
 zapremina vode
 težina 9 kg
 weight



JOLLY

KARAKTERISTIKE | Features

visina 2.26 m height
 rezervoar 25 l
 zapremina vode
 težina 13 kg

SA ISPIRANJEM NOGU



BIG JOLLY

KARAKTERISTIKE | Features

visina 2.29 m height
 rezervoar 40 l
 zapremina vode
 težina 15 kg

SA ISPIRANJEM NOGU



SPRING

KARAKTERISTIKE | Features

visina 2.25 m
 rezervoar 30 l
 zapremina vode
 težina 10 kg
 weight

SA ISPIRANJEM NOGU



DADA

KARAKTERISTIKE | Features

visina 2.25 m
 rezervoar 40 l
 zapremina vode
 težina 22 kg
 weight

SA ISPIRANJEM NOGU



ENERGY PRO

KARAKTERISTIKE | Features

visina 2.26 m
 rezervoar 75 l
 zapremina vode
 težina 45 kg



FUNNY YIN

KARAKTERISTIKE | Features

visina 2.35 m
 mixer za toplu vodu
 težina 7 kg

PERAČ NOGU



FUNNY YANG

KARAKTERISTIKE | Features

visina 2.15 m
 mixer za toplu vodu
 težina 7 kg



HAPPY GO

KARAKTERISTIKE | Features

visina 1.25 m
 rezervoar 23 l
 težina 9 kg

PERAČ NOGU



JOLLY GO

KARAKTERISTIKE | Features

visina 1.25 m
 rezervoar 23 l
 zapremina vode
 težina 9 kg



TUŠ ZA PLAŽU

KARAKTERISTIKE | Features

visina 2.15 m
 serbatoio no
 zapremina vode
 težina 5 kg

HAPPY FIVE



antracite
anthracite
RAL 7016



bela
white
RAL 9003



lila
fuchsia
RAL 4003



zelena
green
RAL 6016



crvena
red
RAL 3027



oranž
orange
RAL 2009



Realizovan od polietilena visoke gustine. Rezervoar kapaciteta 28 L, visina 2,17 m. Opremljen mikserom tople/hladne vode. Dovod vode univerzalnim konektorom.

Made of polyethylene high density. Fuel tank capacity 28 L, height 2,17m. Equipped with hot/cold water mixer. Water inlet with universal hose connector

TUŠ Solare Happy Five/Happy five solar shower

Šifra/ code	1040324	1040319	1040318	1040317	Cena/ price
Boja/ color	antracite anthracite	bela white	zelena green	crven red	415,80 €

Šifra/ code	1040321	1040320	Cena/ price
Boja/ color	Oranž orange	lila fuchsia	464,40 €

TUŠEVI BIG HAPPY FIVE BIG
HAPPY FIVE SHOWERS



antracite
anthracite
RAL 7016



bela
white
RAL 9003



lila
fuchsia
RAL 4003



zelena
green
RAL 6016



crvena
red
RAL 3027



oranž
orange
RAL 2009



Realizovan od polietilena visoke gustine. Rezervoar 40 L, visina 2.15 m. Opremljeni mikserom tople/hladne vode. Dovod vode univerzalnim konektorom.

Made of polyethylene high density. Fuel tank capacity 40 L, height 2.15 m. Equipped with hot/cold water mixer.

Water inlet with universal hose connector.

Tuš Solare Big Happy Five con sciacqua piedi/ Big Happy Five solar shower with rinse feet

Šifra/ code	1040333	1040328	1040327	1040326	Cena/ price
Boja/ color	antracite anthracite	bela white	zelena green	crven red	547,50 €

Šifra/ code	1040330	1040329	Cena/ price
Boja/ color	Oranž orange	lila fuchsia	596,00 €

**TUŠEVI JOLLY E BIG JOLLY JOLLY AND
BIG JOLLY SHOWERS**



Realizovani u potpunosti od aluminijuma i farbani u peći da bi garantovali trajanje, estetiku i kvalitet. Rezervoar kapaciteta 25 L za model Jolly; 40 L za model Big Jolly. Visina 2,26 m za model Jolly; 2,29 m za model Big Jolly. Opremljene mikserom topla/hladna voda. Dotok vode univerzalnim konektorom.

Entirely made of aluminum and painted to ensure durability, aesthetics and quality. Fuel tank capacity 25 L for Jolly model, 40 L for the Big Jolly model. Height 2,26 m for Jolly model, 2,29 m for Big Jolly model. Equipped with hot/cold water mixer. Water inlet with universal hose connector.



antracite
anthracite
RAL 7016

bela
white
RAL 9003

lila
fuchsia
RAL 4003

zelena
green
RAL 6016

crvana
red
RAL 3027

oranž
orange
RAL 2009

Solarni tuš Jolly / Jolly solar shower

Šifra/code	1040286	1040280	1040279	1040278	Cena/price
Boja/color	antracite/anthracite	pesak/sand	zelena/green	crvena/red	755,40 €

Šifra/code	1040282	1040281	Cena/price
Boja/color	oranž/orange	lila/fuchsia	928,70 €

Tuš Jolly sa ispiranjem nogu/ Jolly solar shower with rinse feet

Šifra/code	1040458	1040459	1040462	1040463	Cena/price
Boja/color	antracite/anthracite	pesak/sand	zelena/green	crvena/red	824,70 €

Šifra/code	1040460	1040461	Cena/price
Boja/color	oranž/orange	lila/fuchsia	998,00 €

Doccia Big Jolly con sciacqua piedi / Big Jolly solar shower with rinse feet

Šifra/code	1040295	1040289	1040288	1040287	Cena/price
Boja/color	antracite/anthracite	pesak/sand	zelena/green	crvena/red	963,30 €

Šifra/code	1040291	1040290	Cena/price
Boja/color	oranž/orange	lila/fuchsia	1.136,60 €



Tuš Big Jolly farban inox / Big Jolly solar shower stainless steel

Šifra/code	1040299	Cena/price
Boja/color	farbana Inox/stainless steel	1.136,60 €

TUŠEVI DADA
DADA SHOWERS

Izrađeni u potpunosti od aluminjuma i farbani u peći radi garantovanja trajnosti, estetike i kvaliteta. Na raspolaganju i u verziji čelik inox. Rezervoar kapaciteta 40 L. Visina 2,25 m. Opremljene mikserom toplo/hladna voda i filterom protiv kamenca. Dotok vode univerzalnim konektorom.

Entirely made of aluminum and painted to ensure durability, aesthetics and quality. Also available in stainless steel. Fuel tank capacity 40 L. Height 2,25 m. Equipped with hot/cold water mixer and anti-scale filter. Water inlet with universal hose connector.

					
antracite anthracite RAL 7016	bela white RAL 9003	lila fuchsia RAL 4003	zelena green RAL 6016	crvena red RAL 3027	oranž orange RAL 2009

* Artkli na raspolaganju po narudžbi

Solarni tuš Dada sa ispiranjem nogu / Dada solar shower with rinse feet						
Šifra/code	1040315	1040310	1040309	1040308	1040316	Cena/price
Boja/color	antracite/anthracite	pesak/sand	zelena/green	crvena/red	farbano Inox/stainless steel	2.009,70 €
Solarni tuš Dada sa tempiranim mikserom i peračem nogu / Dada solar shower with timer and rinse feet						
Šifra/code	1040311		1040312		Cena/price	
Boja/color	Lila/fuchsia		oranž/orange		2.183,00 €	
Solarni tuš Dada sa tempiranim mikserom i peračem nogu / Dada solar shower with timer and rinse feet						
Šifra/code	1040465	1040466	1040469	1040470		Cena/price
Boja/color	antracite/anthracite	pesak/sand	zelena/green	crvena/red		2.286,90 €
Šifra/code	1040468		1040467		Cena/price	
Boja/color	Lila/fuchsia		Oranž/orange		2.460,20 €	
Solarni tuš Dada + mali mobilni tuš sa preklopnikom / Dada solar shower +mobile shower with diverter						
Šifra/code	1040471	1040472	1040475	1040476		Cena/price
Boja/color	antracite/anthracite	pesak/sand	zelena/green	crvena/red		2.335,50 €
Šifra/code	1040474		1040473		Cena/price	
Boja/color	lila/fuchsia		oranž/orange		2.508,70 €	
Solarni tuš Dada + nebulizatori e lavapiedi / Dada solar shower +nebulizers and rinse feet						
Šifra/code	1040477	1040478	1040481	1040482		Cena/price
Boja/color	antracite/anthracite	sabbia/sand	zelena/green	crvena/red		2.702,70 €
Šifra/code	1040480		1040479		Cena/price	
Boja/color	lila/fuchsia		oranž/orange		2.876,00 €	
Solarni tuš Dada sa pranjem za noge ofarban inox / Dada stainless steel solar shower with rinse feet painted inox						
Šifra/code	1040316				Cena/price	
Boja/color	farban inox/stainless steel				2.183,00 €	

TUŠEVI SPRING SPRING SHOWERS

antracite
anthracite
RAL 7016

bianco
white
RAL 9003

fuxia
fuchsia
RAL 4003

verde
green
RAL 6016

rosso
red
RAL 3027

arancio
orange
RAL 2009



Izrađen u potpunosti od aluminijuma i farban u pećnici da bi se garantovala trajnost, estetika i kvalitet. Rezervoar kapaciteta 30 L. Altezza 2,25 m. Opremljene mikserom voda topla/hladna. Dotok vode univerzalnim konektorom.

Made entirely of aluminum, painted to ensure durability, aesthetics and quality. Fuel tank capacity 30 L. Height 2,25 m. Equipped with hot/cold water mixer. Water inlet with universal hose connector.

Solarni tuš Spring sa pranjem nogu / Spring solar shower with rinse feet					
Šifra/ code	1040268	1040262	1040261	1040260	Cena/price
Boja/color	antracite anthracite	pesak sand	zeleni green	crveni red	1.032,60 €

Šifra/ code	1040263		1040264	Cena/price
Boja/color	Lila fuchsia	Oranž orange		1.178,10 €

Solarni tuš Spring sa pranjem nogu farbana inox / Spring stainless steel solar shower with rinse feet painted inox			
Šifra/ code	1040267		Cena/price
Boja/color	vern. Inox/stainless steel		1.205,90 €

TUŠEVI ENERGY PRO ENERGY PRO SHOWERS

antracite
anthracite
RAL 7016

sabbia
sand
RAL 9001



Osmišljen za profesionalnu upotrebu, kontinuirano ispušta prijatnu vodu . izrađen u potpunosti od aluminijuma farban u pećnici, radi garantovanja trajnosti, estetike i kvaliteta. Rezervoar kapaciteta 75 l. Visina 2,26 m. Posедуje mikser za vodu toplo/hladno i filter protiv kamenca. Dotok vode univerzalnim konektorom.

Designed for professional use, it is able to deliver a pleasant and continuous water outflow. Entirely made of aluminum, painted to ensure durability, aesthetics and quality. Fuel tank capacity 75 L. Height 2,26 m. Equipped with hot/cold water mixer and anti-scale filter. Water inlet with universal hose connector.

Opis /description		Cena/price
Solarni tuš Energy pro sa ispiraćem nogu Energy pro shower with rinse feet		2.356,20 €

Boje Tuša Energy Pro sa ispiraćem nogu Energy pro shower with rinse feet colors		
Šifra	1040485	1040486
Boja	antracite anthracite	pesak sand

* Artikli na raspolaganju po narudžbi

TUŠEVI

TRADICIONALNI TUŠEVI FUNNY YIN FUNNY YIN TRADITIONAL SHOWERS

 antracite
 anthracite
 RAL 7016

 belo
 white
 RAL 9003



proizveden u polietilenu visoke gustine. Visdina 2,35 m. Opremljene sa mikserom topla/hladna voda.

Made of polyethylene high density. Height 2,35 m. Equipped with hot/ cold water mixer.

Opis /description	Cena/price
Tradicionalni tuš Funny Yin sa ispiračem nogu Funny Yin steel traditional shower with rinse feet	561,40 €

Tradicionalni tuš Funny Yin sa malim pokretnim tušem. Funny Yin steel traditional shower with removable shower head	658,40 €
--	----------

Boje tuša Funny Yin sa ispiračem nogu Funny Yin steel traditional shower with rinse feet colors

Šifra	1040514	1040515
Boja	antracite anthracite	Belo white

Boje Tuša Funny Yin sa pokretnim malim tušem Funny Yin steel traditional shower with removable shower head colors

Šifra	1040517	1040518
Boja	antracite anthracite	belo white

TUŠEVI FUNNY YANG FUNNY YANG SHOWERS



Realizovana u polietilenu visoke gustine. Visina 2,15 m. Opremljene mikserom topla/hladna voda.

Made of polyethylene high density. Height 2,15 m. Equipped with hot/cold water mixer.

Šifra/ code	Opis/description	Cena/ price
1040561	Tradicionalni tuš Funny Yang crni sa ispiračem nogu Funny yang steel traditional shower black with rinse feet	561,40 €

1040562	Tradicionalni tuš Funny Yang nera sa malim pokretnim tušem Funny yang steel traditional shower black with removable shower head	603,00 €
---------	--	----------

TUŠEVI HAPPY GO HAPPY GO SHOWERS

 antracite
anthracite

 belo
white

 lila
fuchsia

 zelena
green



Solarni perač nogu od polietilena visoke gustine, u potpunosti ekološki, idealan za morske ambijente sa mnogo vetra. Idealno rešenje za kupališta, kampinge, hotele. Opremljen sistemom za fiksiranje, antikorozivni garantovani materijal. Rezervoar kapaciteta 20 L. Visina 1,25 m. Opremljen miskerom toplo/hladna voda. Dotok vode univerzalnim konektorom.

Solar foot washer in polyethylene high-density, totally ecological, ideal in windy marine environments. Ideal for bathing establishments, campings, hotels. Equipped with fastening systems, material guaranteed against corrosion. Fuel tank capacity 20 L. Height 1,25 m. Equipped with hot/cold water mixer. Water inlet with universal hose connector.

Solarni perač nogu Happy Go / Happy Go solar foot washer

Šifra/code	1040435	1040436	1040438	Cena/price
Boja/color	antracite anthracite	bela white	zelena green	408,90 €

Šifra/code	1040437	cena/price
Boja/color	lila fuchsia	457,40 €

TUŠEVI JOLLY GO JOLLY GO SHOWERS



Solarni perač nogu od aluminijuma, u potpunosti ekološki.

Opremljen sistemima za fiksiranje, garantovani antikorozivni materijal. Rezervoar kapaciteta 12 L. Visina 1,25 m. Opremljen miskerom topla/hladna voda. Dotok vode sa univerzalnim konektorom.

Solar foot washer in aluminium, totally ecological. Equipped with fastening systems, material guaranteed against corrosion. Fuel tank capacity 12 L. Height 1,25 m. Equipped with hot/cold water mixer. Water inlet with universal hose connector.

Šifra /code	2023-02-01	Cena/price
1040440	Solarni perač nogu Jolly Go antracite Jolly Go solar foot washer anthracite	672,30 €

ACCESSORI
ACCESSORIES



cod.1040433



cod.1040439



cod.1040434

Codice / code	Descrizione /description	Prezzo/ price
1040433	Staffa di fissaggio antivandalico e antifurto per Happy e Joly / Vandalism and anti-theft bracket for Happy and Joly	242,60 €
1040434	Sistema di fissaggio a vite per sabbia e prato / Screw fixing system for sand and grass	90,10 €
1040439	Filtro anticalcare H12,5 L 6,5 per modelli in alluminio / Descaling filter H12,5 L 6,5 for alluminium models	131,70 €

DOCCIA DA SPIAGGIA / BEACH SHOWER

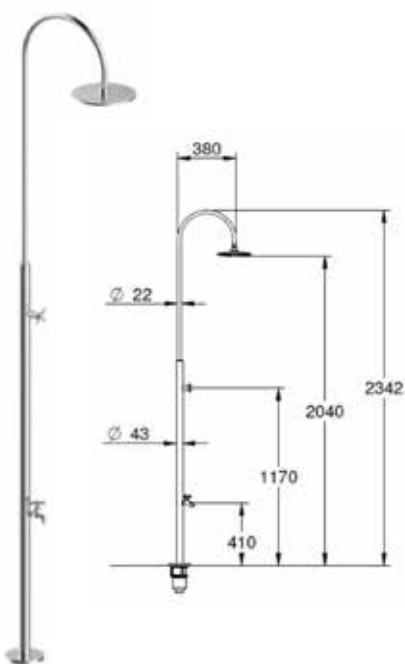

Doccia in acciaio inox 304 con sciacqua piedi. Incluso ancoraggio Ø43 che permette un facile montaggio/smontaggio, attacco femmina 1/2".

Stainless steel 304 shower with feet rinser. Included Ø43 anchor that allows easy assembly/disassembly, female 1/2".

Codice / code	Descrizione /description	Prezzo/ price
1040209	Doccia da spiaggia in acciaio inossidabile con sciacqua piedi / stainless steel beach shower with rinse feet	584,40 €



Ancoraggio
Anchor

PIATTO DOCCIA LAKE / LAKE SHOWER TRAY

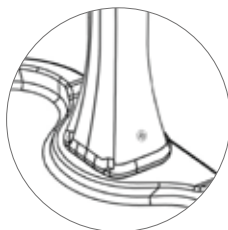

Installazione versione autoportante
Self-supporting installation

Struttura realizzata in polietilene, superficie antiscivolo, effetto pietra. Scarico orizzontale che consente il montaggio senza fori a pavimento o modifiche strutturali. Resistente ai raggi UV, alla salsedine, anticalcare. Rende la doccia autoportante e facilmente spostabile per eventuali successive riambientazioni. Nella versione autoportante utilizzabile con docce: Happy Five, Joly e Joly Go.

Structure made of polyethylene, non-slip surface, stone effect. Horizontal drain that guarantees the assembly without drilling the surface nor structural changes. UV rays and salt resistant, anti-limescale. The shower base makes the shower self standing and easy to move in case of relocation. Self-supporting version with Happy Five, Joly e Joly Go.

Descrizione /description	Prezzo/ price
Piatto doccia in PE "lake" dim. 103x107 cm Shower base PE "Lake" dim. 103x107 cm	408,90 €

Colori Piatto doccia Lake
Shower base Lake colors

Codice	1040430	1040431	1040432
Colore	antracite	bianco	verde



antracite
anthracite



bianco
white



verde
green

VASCHETTA LAVA-PIEDI / FEET WASHBASINS

In vetroresina con finitura gel-coat bianco o celeste. Complete di scarico con rosetta in acciaio cromato.
 Fiberglass gel-coat finish white or blue. Complete with exhaust with chrome steel washer.

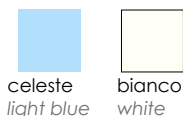

Vaschetta 80x100xh8 cm
 Basin foot-washing

Colori vaschetta accesso facilitato
 Basin foot-washing easy transition colors

Descrizione /description	Prezzo/price
Vaschetta lava piedi 80 x 100 x h8 cm / Basin foot-washing 80x100x8	250,00 €
Vaschetta lava piedi 80 x 100 x h20 cm / Basin foot-washing 80x100x20	300,00 €
Vaschetta lava piedi 200 x 100 x h20 cm / Basin foot-washing 200x100x20	602,00 €
Vaschetta lava piedi con accesso facilitato / Basin foot-washing with easy transition	967,50 €

Colori vaschetta 80x100xh8 cm Basin foot-washing colors			Colori vaschetta 80x100xh20 cm Basin foot-washing colors			Colori vaschetta 200x100xh20 cm Basin foot-washing colors			Colori vaschetta accesso facilitato Basin foot-washing easy transition colors		
Codice	1040214	1040235	Codice	1040212	1040236	Codice	1040213	1040237	Codice	1040227	1040238
Colore	bianca	celeste	Colore	bianca	celeste	Colore	bianca	celeste	Colore	bianca	celeste

VASCA LAVAPIEDI CON ACCESSO FACILITATO FEET WASHBASINS WITH EASY ACCESS



La vaschetta lavapiedi con accesso facilitato realizzata in vetroresina, è una vaschetta che, grazie alla sua pendenza dell'8%, facilita l'accesso in piscina alle persone con disabilità. Disponibile in più colori, è composta da due moduli componibili.

The feet washbasin with easy access made of fiberglass is a tub that, thanks to its 8% slope, facilitates access to the pool for people with disabilities. Available in multiple colors, it consists of two modular modules.



Pendenza	8%
Moduli	2
Dimensione singolo modulo	2500x1130x90 mm
Ingombro due moduli	5025x1130x90 mm

Codice /code	Descrizione /description	Prezzo/price
1040229	Vasca lavapiedi con accesso facilitato bianca/ Feet washbasin with easy access for the disabled white	1.886,00 €
1040230	Vasca lavapiedi con accesso facilitato sabbia/ Feet washbasin with easy access for the disabled sand	1.886,00 €
1040231	Vasca lavapiedi con accesso facilitato celeste/ Feet washbasin with easy access for the disabled light blue	1.886,00 €

LEŽALJKE - TOBOGANI

SERENDIPITY PODNI ILI PLUTAJUĆI / SERENDIPITY FOR FLOOR OR FLOATING

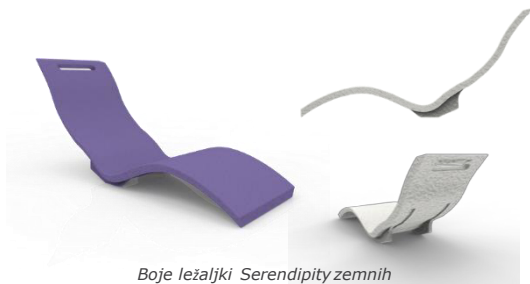

Boje ležaljki Serendipity zemnih
Serendipity chair for floor colors



Boje fotelje Serendipity plutajuća
Serendipity floating chair colors



Realizovana od polietilena, površinski efekat kamena

SERENDIPITY podni: Njegova podesiva struktura čini ga najboljim izborom za kućnu upotrebu ili za bogaćenje bazena i wellness centara. Širina 59 x dužina min.144/max.171 x visina min.69/max 100 cm.

SERENDIPITY PLUTAJUĆI: kompletna sa plutajućim rukohvatima od polietilena sa nosačem flaša. Širina 84 x dužina min.169 x visina 74 cm.

Made entirely of polyethylene, surface stone effect

FLOOR SERENDIPITY: complete of chromed support base. Its adjustable structure makes it the perfect choice for domestic use or for enriching pools and wellness centers. Width 59x length min.144/max.171 x height min.69/max 100 cm.

FLOATING SERENDIPITY: complete of polyethylene floating armrests with bottle holder. Width 84x length 169x height 74 cm.



Ležaljka Serendipity podna/Serendipity chair for floor

Šifra/ code	1040350	1040351	1040354	1040355	Cena/ price
----------------	---------	---------	---------	---------	----------------

Boja/ color	antracite/ anthracite	bela/ white	zelena/ green	crvena/red	408,90 €
----------------	--------------------------	----------------	------------------	------------	----------

Šifra/ code	1040353	1040352	Cena/ price
----------------	---------	---------	----------------

Boja/ color	Lila/fuchsia	Oranž/orange	457,40 €
----------------	--------------	--------------	----------

Ležaljka Serendipity plutajuća/Serendipity floating chair

Šifra/ code	1040390	1040391	1040394	1040395	Cena/ price
----------------	---------	---------	---------	---------	----------------

Boja/ color	antracite/ anthracite	bela/ white	zelena/ green	crvena/red	866,30 €
----------------	--------------------------	----------------	------------------	------------	----------

Šifra/ code	1040393	1040392	Cena/ price
----------------	---------	---------	----------------

Boja/ color	Lila/fuchsia	Oranž/orange	914,80 €
----------------	--------------	--------------	----------

PRISCILLE

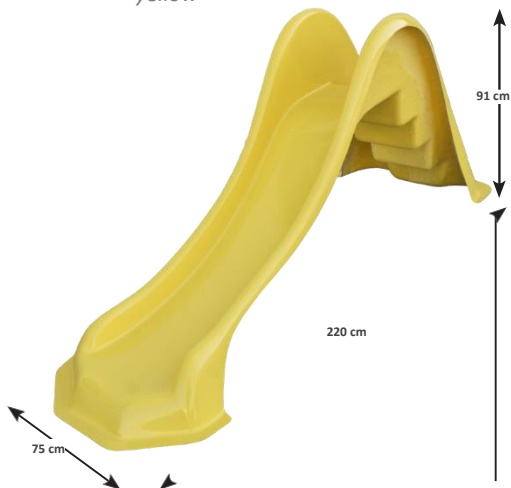
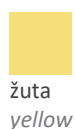

Tobogan od fiberglasa modernog dizajna. Stepenište ima 4 široka stepenika i ivične držače radi omogućavanje lakog i bezbednog hvatanje i za najmanje ručice. Dve boje na raspolaganje: žuta i crvena. širina 75 cm, dužina 220 cm - Visina 91 cm

Water slide in fiberglass of modern design. The scale has four wide steps and grip edge to ensure a safe grip children's hands. Available in two colors: yellow and red.

Width 75 cm- Leght 220 cm - Hight - 91 cm

Šifra / code	Opis /description	Cena/ price
1040444	Tobogan Priscille / Water slide Priscille	739,50 €



PRECISIO ALARM / PRECISIO ALARM

Alarm Precisio kontinuirano analizira talase koje pravi vaš bazen i detektuje uranjanje nekog tela u bazen i upozorava preko ugrađene jake sirene. Precisio je sačinjen od jedinice za detekciju a instalira se na ivice bazena. Posедуje novi ultra jaki mikroprocesor, koji može napraviti hiljade proračuna u sekundi, alarm PRECISIO, sa najnovijim tehnologijama stalno analizira kontinuirano stvorene talase vašeg bazena. Njegove napredne funkcije prerade signala omogućuju da razlikuje moguće opadanje prekida vezanih za meteorološke uslove od servisne opreme (robot, filtracija...). Modernog dizajna, potpuno se uklapa u ambijent vašeg bazena. Precisio se instaliraje jednostavno a prilagodljiv je većini bazena. Kada se želi plivati dovoljno je isključiti alarm ukucavanjem ličnog PIN-a. Posle plivanja uključuje se automatski. Precisio je certifikovan ISO9001.

The Precisio alarm continuously analyzes the waves generated by your pool and detects the immersion of a body in the pool and warns thanks to its powerful integrated siren. Precisio consists of a detection unit and is installed by the pool. Equipped with a new ultra-powerful microprocessor, capable of doing thousands of calculations per second, the Precisio alarm, with the latest technologies constantly analyzes the waves generated in your pool. Your advanced signal processing capabilities allow you to distinguish possible falls due to meteorological conditions or service equipment (robots, filtration...). With a modern design, it fits perfectly into the environment of your pool. Precisio installs easily and suits most pools. When you want to swim, simply turn off the alarm by entering your PIN. After swimming, the reboot will automatically take place. Precisio is ISO9001 certified.

Šifra / code	Opis/description	Cena / price
1042050	Precisio alarm / Alarm Precisio	1.056,00 €



SIGURNOSNA OGRADA BETH / BETH SECURITY FENCE



Sistem zaštite bazena u privatnoj upotrebi. Realizovana modularnim sistemom onemogućava pristup bazenu dece. Potka tekstila dalje, omogućava pun pregled bazena zahvaljujući svojoj providnosti. Mreža se lako demontira i instalira. Svaka sekcija (od 1 do 15m) je sastavljena preko zasuna koji inemogućavaju deci da ih onesposobe. Nosači su mnотirani duž svakog metra na mreži radi optimalne zategnutosti a moraju se fiksirati u zemlju sa rupama Ø30 ili Ø16 prema tome dali je zona instalacije vetrovita ili sa nepravilnim terenom.

Dužina: modularna
Visina: 122 cm

Swimming pool protection system for private use. Made with a modular system it prevents the access of children to the pool area. The fabric texture allows to have full view of the pool thanks to its transparency. The network is easy to disassemble and install. Each section (1 to 15m) is connected through bolts that do not allow children to tamper with them. The pegs are mounted every meter on the grid for optimal voltage and must be fixed to the ground with holes Ø30 or Ø16 depending on whether the installation area is windy or with an uneven ground Length: adjustable
Height: 122 cm



Cod. 1060710 – Mala ograda Easy Demontažna: bušenje Ø16 ili Ø30 mm. Centralna kapija + 2 rigidne bočne sekcije. Fiksiranje na ravnoj i glatkoj površini radi omogućavanja korektnog zatvaranja brave. Dimenzije 122 x h.122cm
Cod. 1060710 - Easy gate
Removable: drilling Ø16 or Ø30 mm.
Central knocker + lateral rigid sections. Fixing on flat and smooth ground to allow a correct closure of the lock. Dimensions 122 x h.122 cm



Cod. 1060711 – Mala ograda Platinum Fiksiranje na ravnoj i glatkoj površini radi omogućavanja korektnog zatvaranja brave. Dim.100 x h.122 cm
Cod. 1060711 - Platinum gate
Fixing on flat and smooth ground to allow a correct closure of the lock. Dimensions 100 x h.122 cm

Standardne Boje

1. Zelena mreža + eloksirani sivi kočič
2. Crna mreža + eloksirani sivi kočič
3. Crna mreža + crni kočič

STANDARD COLORS

green net + gray anodised poles black net + gray anodised poles black net + black poles



Šifra / code	Opis/description		cena / price
1060708	Sigurnosna ograda Beth Beth security fence	po ml per ml	62,50 €
1060710	Demontažna ograda Easy 122x122 cm Removable gate Easy 122x122 cm	po ml per ml	992,30 €
1060711	Demontažna ograda Platinum 100x122 cm Removable gate Platinum 100x122 cm	po ml per ml	992,30 €
	Set za instalaciju patosa (perperimetre do 30/40m):	po ml	
1060712	1 smola Epoxy, 1 zasun, 1 prekrivka zemljišta, 1 cev PVC 1 ml Floor installation kit (for perimeters up to 30/40m): 1 Epoxy resin, 1 bolt, 1 cover soil, 1 PVC pipe 1 ml	Po ml	80,90 €

PERSONALIZOVANE PONUDE NA UPIT / CUSTOMIZED ESTIMATES ON REQUEST

STEPENICE - LADDERS



TRIANON

cev tube Ø 43 cm čelik
 materijal material 304/316 steel 304/316



CHAMBO RD

cev tube Ø 43 cm čelik
 materijal material 304/316 steel 304/316



ORLEANS

cev tube Ø 42 cm čelik
 materijal material 304/316 steel 304/316



REMY

cev tube Ø 42 cm
 materijal material čelik 304 steel 304



MOD . FINLANDESE

cev tube Ø 43 cm
 materijal material čelik 316 steel 316



PONTE SCALA

cev tube Ø 43 cm
 materijal material čelik 304 steel 304



STEPENICE LAKOG PRISTUPA

cev tube Ø 43 cm
 materijal material čelik 316 steel 316



DVOSTRUKO STEPENIŠTE OD SMOLE

rukohvati handrails produžni extensible
 materijal material smola resin



STEPENICE OD SMOLE

rukohvati handrails produžni extensible
 materijal material smola resin

TRIANON 304 E 316



304: Izrađene od cevi Ø 43 mm od inox čelika 304. Stepenici su od čelika inox sa rešetkom od armirane smole. Isporučka sa kompletnom opremom za instalaciju.

316: Izrađene od cevi Ø 43 mm čelik inox 316. Stepenici su od inox čelika. isporučena sa kompletnom opremom za montažu.

304: Made with tube Ø 43 mm in stainless steel 304. The steps are in stainless steel with ring in reinforced resin. Supplied with all accessories for installation.

316: Made with tube Ø 43 mm in stainless steel 316. The steps are in stainless steel. Supplied with all accessories for installation.

Šifra/code	Opis/description	cena/price
1025013	Stepenice Trianon 304 inox sa 3 stepenika INOX / 304 with 3 steps	425,20 €
1025014	Stepenice Trianon 304 inox sa 4 stepenika INOX / 304 with 4 steps	501,70 €
1025002	Stepenice Trianon 316 inox sa 2 stepenika INOX / 316 with 2 steps	504,90 €
1025004	Stepenice Trianon 316 inox sa 3 stepenika INOX / 316 with 3 steps	569,40 €
1025006	Stepenice Trianon 316 inox sa 4 stepenika INOX / 316 with 4 steps	651,10 €
1025008	Stepenice Trianon 316 inox sa 5 stepenika INOX / 316 with 5 steps	738,90 €

Šifra	a [mm]
1025002	696
1025013 - 1025004	946
1025014 - 1025006	1196
1025008	1446

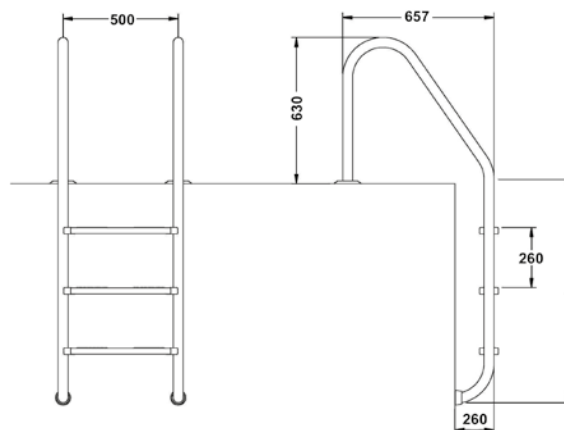

CHAMBORD



Izrađene od cevi Ø 43 mm od inox čelika 316. Stepenici su od inox čelika. Isporučene sa komplet opremom za montažu.

Made with tube Ø 43 mm in stainless steel 316. The steps are in stainless steel. It's complete with all accessories for the installation.

Šifra/code	Opis/description	Cena/price
	MODEL SA UZIDNIM SLIVNIKOM 316 / 316 WITH BUILDING MAIN DRAIN	
1025026	Stepenice Chambord 316 con 2 stepenika INOX / with 2 steps	504,40 €
1025028	Stepenice Chambord 316 con 3 scalini INOX / with 3 steps	602,40 €
1025030	Stepenice Chambord 316 con 4 scalini INOX / with 4 steps	674,40 €
1025032	Stepenice Chambord 316 con 5 scalini INOX / with 5 steps	756,10 €

Šifra	a [mm]
1025026	696
1025028	946
1025030	1196
1025032	1446

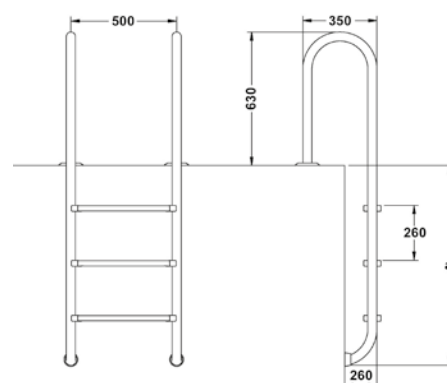

Stepenice, izlaz iz bazena i rukohvat od čelika inox 304 nisu kompatibilni elektroliznom tretmanu.

The ladders and the handrails in stainless steel are not compatible with treatments of electrolysis.

ORLEANS



304: Izrađene od cevi Ø 42 mm čelim inox 304, debljina 0,9 mm. Stepenci su od inox čelika. Opremljene sa komplet opremom za instalaciju.

316: Izrađene od cevi Ø 42 mm čelik inox 316, debljine 1,1 mm. Stepenci su od inox čelika. Opremljene sa komplet opremom za instalaciju.

304: Made with tube Ø 42 mm in stainless steel 304, thickness 0,9mm. The steps are in stainless steel. It's complete with all accessories for the installation.

316: Made with tube Ø 42 mm in stainless steel 316, thickness 1,1mm. The steps are in stainless steel. It's complete with all accessories for the installation.

Šifra / code	Opis/description	Cena/ price
1025016	Stepenice Orleans inox 304 sa 3 stepenika INOX, cev Ø42 / with 3 steps, tube Ø42	221,40 €
1025017	Stepenica Orleans inox 304 sa 4 stepenika INOX, cev Ø42 / with 4 steps, tube Ø42	241,50 €
1025018	Stepenice Orleans inox 316 con 3 stepenika INOX, cev Ø42 / with 3 steps, tube Ø42	348,80 €
1025019	Stepenice Orleans inox 316 con 4 stepenika INOX, cev Ø42 / with 4 steps, tube Ø42	382,40 €

Šifra	A [mm]	B [mm]	C [mm]	D [mm]	E [mm]	F [mm]
1025016	645	720	250	850	180	500
1025017	645	720	250	1100	180	500
1025018	645	720	250	850	180	500
1025019	645	720	250	1100	180	500

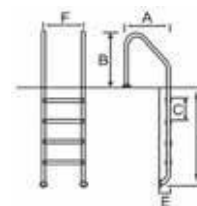

REMY



Izrađene od cevi Ø 42 mm od inox čelika 304, debljine 0,9 mm. Stepenice su od inox čelika. Opremljene svim delovima za instalaciju.

Made with tube Ø 42 mm in stainless steel 304, thickness 0,9mm. The steps are in stainless steel. It's complete with all accessories for the installation.

Šifra /code	Opis /description	Cena/ price
MODEL SA UZIDNIM SLIVNIKOM / MODEL WITH BUILDING MAIN DRAIN		
1025020	Stepenica Remy SA 3 stepenika INOX 304, cev Ø42 / with 3 steps, tube Ø42	207,90 €
1025029	Stepenica Remy SA 3 stepenika INOX 316, cev Ø42 / with 3 steps, tube Ø42	325,30 €
MODEL SA PLOČICOM ZA FIKSIRANJE ZA DRVENE BAZENE / MODEL WITH PLATE FOR WOODEN POOL		
1025021	Stepenice Remy pločica sa 3 stepenika INOX 304, cev Ø42 /with plate, 3 steps	259,30 €

Šifra	A [mm]	B [mm]	C [mm]	D [mm]	E [mm]	F [mm]
1025020	320	630	250	930	180	500
1025029	320	630	250	930	180	500
1025021	320	630	250	930	180	500

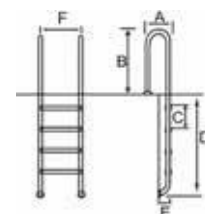
FINSKI MODEL ZA PRELIVNU IVICU
FINNISH MODEL FOR OVERFLOW EDGE

Proizvedene od čelične inox cevi 316 - prečnika Ø 43 mm. Stepenci su od inox čelika 316. Opremljene svim delovima za instalaciju.

Made with tube Ø 43 mm in stainless steel 316. The steps are in stainless steel. Supplied with all accessories for the installation.

Šifra /code	Opis/description	Cena/ price
1025081	Finska stepenica za prelivnu ivicu sa 3 stepenika / for overflow edge with 3 steps	1.052,70 €
1025082	Finska stepenica za prelivnu ivicu sa 4 stepenika / for overflow edge with 4 steps	1.131,30 €
1025083	Finska stepenica za prelivnu ivicu sa 5 stepenika / for overflow edge with 5 steps	1.088,70 €

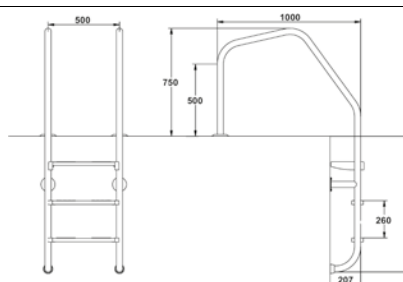

Šifra	a [mm]
1025081	946
1025082	1196
1025083	1446

KIT PER LINER COD. 1025122 ESCLUSO PAG. 322

MOSTNE STEPENICE-DUPLE ZA NADZEMNE BAZENE / BRIDGE-DOUBLE LADDER FOR ABOVE-GROUND POOLS



Proizvedene od inox čelične cevi 304 - prečnik Ø 43 mm.
Made with tube Ø 43 mm in stainless steel 304.

Šifra/ code	Opis/description	cena/ price
1025100	Mostne stepenice sa 4/4 stepenika / Ponte ladder with 4/4 steps	769,80 €
1025101	Mostne stepenice sa 5/5 stepenika / Ponte ladder with 5/5 steps	854,30 €

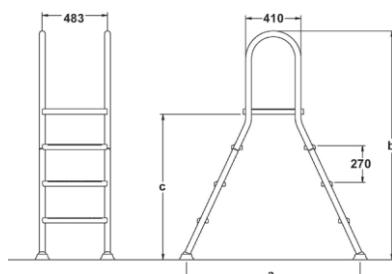

Šifra	a [mm]	b [mm]	c [mm]
1025100	1350	1900	1295
1025101	1545	2130	1525

IZLAZ ZA BAZEN / HANDRAILS



Izlazi za bazen od inox čelika 316 - prečnik Ø 43 mm, isporuka po izboru za uziđivanje ili sa pločama sa tiplovima za fiksiranje. Fiksiraju se na ivicama.

Handrails in stainless steel 316 - Ø 43 mm, given to be built or with plate with fixed block. To be fixed on the coping stone.

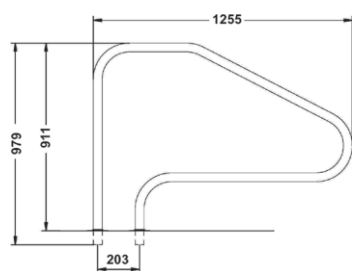

Šifra/ code	Opis/description	Cena/ price
	UZIDNI MODEL 316 / MODEL TO BE BUILT-IN 316	
1025060	Uzidni bazenski rukohvat / Handrail to be built-in	362,30 €
	MODEL SA PLOČAMA ZA FIKSIRANJE 316 / WITH WELDED FLANGE 316	
1025062	Bazenski izlaz sa pločom za fiksiranje / Handrail with welded flange	400,10 €

IZLAZI BAZENA / POOL EXITS



Uzidni izlazi bazena od čelika inox 304 - Ø42 mm - debljine 1,1 mm, za fiksiranje na ivicama. Prodaja isključivo u paru.
Pool exits in stainless steel 304 - Ø42 mm, thickness 1,1 mm given to be built. To be fixed on the coping stone. Sold in pairs only.

Šifra /code	Opis /description	cena/ price
1025063	Izlaz iz bazena INOX 304 uzidni 800 / Outputs pool wall 800 La coppia / the couple	201,30 €
1025064	Izlaz iz bazena INOX 304 uzidni 1250 / Outputs pool wall 1250 La coppia / the couple	268,30 €

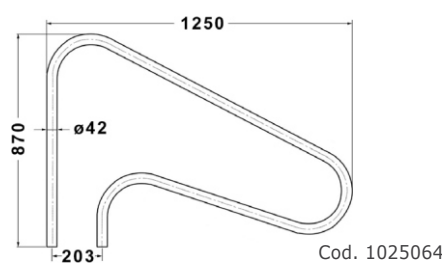
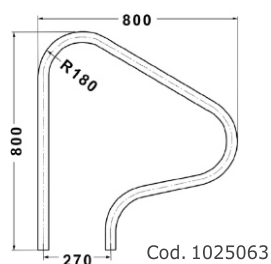
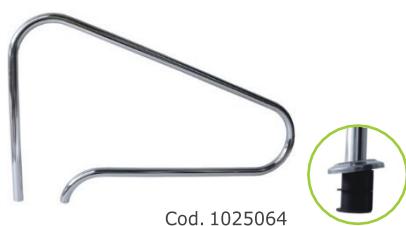

Stepenice, izlazi iz bazena i rukohvati čelika inox 304 nisu kompatibilni sa elektroliza tretmanima.
The ladders, pool exits and handrails in stainless steel are not compatible with electrolysis treatments.

STEPENICE LAKOG PRISTUPA / EASY ACCESS LADDER



Proizvedene od cevi čelika inox 316 - prečnika Ø 43 mm. Stepene 457x325 mm protivklizne. Mogućnost adaptacije na različite dubine. Preporučuju se osobama smanjene pokretljivosti.

Made with tube Ø 43 mm in stainless steel 316. Antislip steps 457x325 mm. Adaptability to different depths. Recommended for people with reduced mobility.

Šifra / code	Opis/description	Cena / price
1025105	Stepenice lakog pristupa sa 5 /stepenika easy access with 5 steps	4.242,70 €
1025106	Stepenice lakog pristupa sa 6 stepenika / easy access with 6 steps	4.656,30 €
1025107	Stepenice lakog pristupa sa 7 stepenika / easy access with 7 steps	5.145,10 €

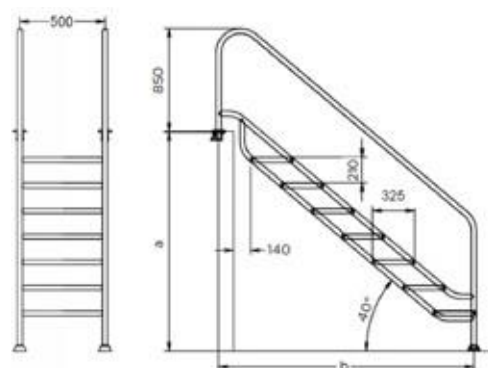

Codice	a [mm]	b [mm]
1025105	1180-1380	1600
1025106	1390-1590	1850
1025107	1600-1800	2100

PRILAGODLJIVE DVOSTRUKE STEPENICE OD SMOLE ZA NADZEMNE BAZENE
TERRA DOUBLE LADDER IN RESIN ADJUSTABLE FOR ABOVE GROUND POOLS



Stepenice od smole otporne na UV, prilagodljive po visini od 122cm do 137 cm. Može se podizati i blokirati sa katancem iznad platforme, onemogućavajući tako ulaz u bazen. Platforma i stepenici su od protivklizne smole. Rukohvati na razvlačenje za veću sigurnost. Posebna rotirajuća potporna baza, podešava se da bi se izbeglo oštećenje podloge za veću stabilnost. Struktura jednostavne montaže, nosivost max 160 kg.

Ladder in resin, UV resistant, adjustable in height from 122cm to 137 cm. Can be lifted and lock with a padlocked above the platform, preventing the entry in the pool. The platform and steps are in antislip resin. Extensible handrails for more security. Special base plate rotatable, it tilts for not damage the liner and for greater stability. Installer-friendly design, maximum weight: 160 kg

Šifra / code	Opis/description	Cena / price
1025097	Dvostruke stepenice od smole / Double ladder in resin	534,20 €

PODESIV STEPENICE OD SMOLE ZA PODZEMNE BAZENE
LADDER IN RESIN ADJUSTABLE FOR INGROUND POOLS



Stepenice od smole, sa podesivom visinom i potpornom bazom, za podzemne bazene. Visina stepenica se može podešavati, od 122 cm do 137 cm, dizajnirane da se najbolje prilagode svakoj vrsti montaže. Upotreba visokokvalitetne smole omogućava da stepenice izdrže maksimalnu težinu od 135 kg. Potporna baza na dnu bazena je rotirajuća, podešavanje nagiba jamči najbolju stabilnost i izbegava oštećenja obloge. Rukohvati stepenica, koji se mogu produžiti za 25 cm, garantuju bolju pomoć pri izlasku i ulasku u bazen, što olakšava penjanje uz stepenice. Montaža stepenica je jednostavna. Budući da se gornja platforma ne oslanja na gornju konstrukciju bazena, štiti ga od oštećenja usled težine.

Ladder in resin, with height and base adjustable, for inground pools. The height of the ladder can be changed, from 122 cm to 137 cm, it is designed to best fit in any type of installation. The usage of high quality resin allows the ladder to support a maximum weight of 135 kg. The support base at the bottom of the tank can be rotated, adjusting the inclination ensures the best stability and avoids to damage to the liner. The ladder handrails, extendable to 25 cm, provide better assistance both at the exit and at the entrance from the pool, facilitating the climb of the steps. The installation of the ladder is simple. The upper platform does not lean on the upper structure of the pool, it protects it from damage due to weight.

Šifra / code	Opis/description	Cena / price
1025098	Stepenice od smole / Ladder in resin	327,70 €



KLASIČNA

KARAKTERISTIKE | Features

cev \varnothing 43 cm
tube

materijal čelik 316
material steel 316



LAKOGA PRISTUPA

KARAKTERISTIKE | Features

cev \varnothing 43 cm
tube

materijal čelik 316
material steel 316



RAMBOUILLET

KARAKTERISTIKE | Features

cev \varnothing 43 cm
tube

materijal čelik 316
material steel 316



SKY

KARAKTERISTIKE | Features

cev \varnothing 43 cm
tube

materijal čelik 316
material steel 316

KLASIČNE STEPENICE / CLASSIC LADDER



Proizvedene od cevi čelika inox 316 - prečnik Ø 43 mm. Opremljene svim delovima za montažu.
Tube Ø 43 mm in stainless steel 316. Complete with all accessories for the installation.

Šifra/ code	Opis/description	Cena/ price
1025108	Stepenice Classica sa tretmanom elektročišćenja 3 stepenika / Classic with electro cleaning treatment with 3 steps	721,20 €
1025109	Stepenice Classica sa tretmanom elektročišćenja 4 stepenika/ Classic with electro cleaning treatment with 4 steps	789,60 €

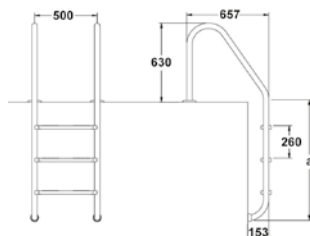

Šifra	a (mm)
1025108	946
1025109	1196

STEPENICE LAKOG PRISTUPA / EASY ACCESS LADDER



Proizvedene od cevi čelika inox 316 - prečnika Ø 43 mm. Dvostruki sigurnosni stepenici. Opremljeni sa svim delovima za montažu.
Made with tube Ø 43 mm in stainless steel 316. Double security steps. Complete with all accessories for the installation.

Šifra/ code	Opis/description	Cena/ price
1025102	Stepenica lakoga pristupa sa tretmanom elektročišćenja 3 stepenika / Easy access with electro cleaning treatment with 3 steps	1.481,50 €
1025103	Stepenica lakog pristupa sa tretmanom elektročišćenja 4 stepenika / Easy access with electro cleaning treatment with 4 steps	1.764,40 €

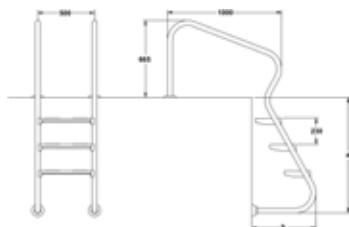

Šifra	a [mm]	b [mm]
1025102	1005	511
1025103	1225	630

RAMBOUILLET SAČINJENA IZ DVA DELA ZA BAZENE SA PREKRIVKAMA
 RAMBOUILLET IN 2 PARTS, FOR POOLS WITH COVER

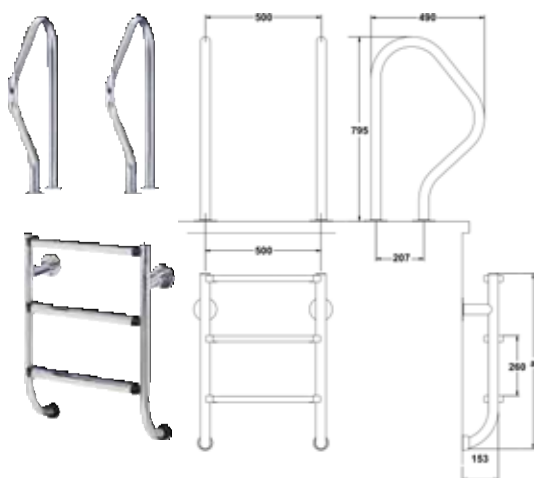

Proizvedene od čelika inox 316 - prečnik Ø 43 mm. Stepenici od čelika inox. Opremljene sa svim delovima za montažu.

Made with tube Ø 43 mm in stainless steel 316. The steps are in stainless steel. Complete with all accessories for the installation.

Šifra/ code	Opis /description	Cena/ price
1025034	Stepenice Rambouillet sa 2 stepenika inox / with 2 inox steps	1.250,60 €
1025036	Stepenice Rambouillet con 3 scalini inox / with 3 inox steps	1.372,30 €
1025038	Stepenice Rambouillet con 4 scalini inox / with 4 inox steps	1.391,00 €
1025039	Stepenice Rambouillet con 5 scalini inox / with 5 inox steps	1.474,40 €

Šifra	1025034	1025036	1025038	1025039
a [mm]	515	765	1015	1265

KIT PER LINER COD. 1025122 ESCLUSO PAG. 322

SCALA SKY / SKY LADDER



Proizvedene od cevi čelik inox 316 - prečnik Ø 43 mm.
Stepenici su od čelika inox. Opremljene sa komplet opremom za montažu.

Made with tube Ø 43 mm in stainless steel 316. The steps are in stainless steel. Complete with all accessories for the installation.

Šifra/ code	Opis/description	Cena/ price
1025022	Stepenice Sky sa elektroliza tretmanom 3 stepenika/ Sky with electro cleaning treatment with 3 steps	1.357,80 €
1025023	Stepenice Sky con trattamento di elettropulizia 4 scalini / Sky with electro cleaning treatment with 4 steps	1.435,80 €

kit per liner cod. 1025122 escluso pag. 322

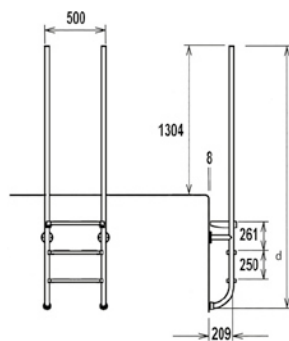

Šifra	1025022	1025023
d [mm]	2315	2565

SPOJEVI ZA STEPENICE / JOINTS FOR LADDERS

Zglobovi za stepenice su proizvedeni od inox čelika / The joints for ladders are in stainless steel.

Šifra/ code	Opis/description	Cena/ price
1025044	Spoj za cev stepenice di Ø 43 mm, sa prirubnicom, čelik inox 304 par / Joint for the tube Ø 43 mm of the ladder, with flanges, in stainless steel 304 the couple	127,20 €
1025045	Zglobni spoj, cevni za stepenice di Ø 43 mm, sa prirubnicom, čelik inox 304 par / Swivel joint for the tube Ø 43 mm of the ladder, with flanges, in stainless steel 304 the couple	283,40 €
1025047	Zglobni spoj, za cev stepenica di Ø 43 mm, čelik inox 304 par / Swivel joint for the tube Ø 43 mm of the ladder, in stainless steel 304 the couple	944,30 €
1025122	Set za podlogu za stepenice inox – neophodan za stepenice Sky - Rambouillet - Finske par / Kit for stainless steel stair liner necessary for ladder Sky - Rambouillet - Finlandese the couple	202,00 €



cod.1025044

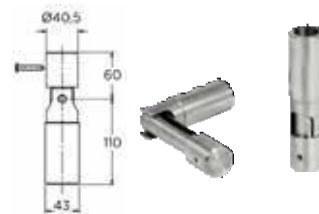

cod.1025047

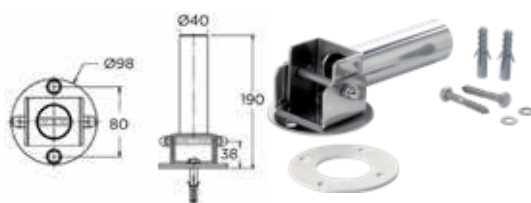

cod.1025045



cod.1025122

RUHOHVAT INOX / INOX HANDRAIL

ŠIFRA/ code	OPIS/description	CENA/ price
1025114	Cev dužine1000, čelik inox 316 / tube 1000 m, stainless steel 316	94,70 €
1025115	Cev dužine 2000, čelik inox 316 / tube 2000 m, stainless steel 316	175,20 €
1025116	Cev dužine 3000, čelik inox 316 / tube 3000 m, stainless steel 316	264,40 €
1025117	Cev za spajanje 180°, čelik inox 316 / connection tube 180°, steel 316	61,40 €
1025118	Cev za spajanje 90°, čelik inox 316 / connection tube 90°, steel 316	111,70 €
1025119	Čep cevi Ø 43 mm / cap of the tube Ø 43 mm	2,50 €
1025120	Držać cevi, čelik inox 316 / support of the tube, stainless steel 316	59,20 €
1025121	Krajni držać cevic, čelik inox 316 / sfinal upport of the tube, steel 316	75,90 €
1025124	Set za podlogu za držanje cevi / kit for liner for the support of the tube	92,70 €



cod.1025115



cod.1025117



cod.1025118



cod.1025120



cod.1025121

SKAKAONICA WINNER 160 / WINNER 160 SPRINGBOARD DIVING



U skladu NORMI EN 13451-10

Compliance with the standard EN 13451-10

Skakonica od poliester i fiberglasa boja BELO Ili SVETLO PLAVA.

Daska od smole dužine 1.70 m, širine 0.49 m. Kompletan za uzidnim kavezom od čelika, šrafovi inox, rozetne od aluminijuma.

Diving board in PE and glass fiber, color white or light blue. Board in resin, length 1,70 m, width 0,49 m. Complete with box to be built, steel screws, aluminum rosettes.



celeste
light blue



bianco
white

Šifra /code	Opis/description	Cena/price
SKAKAONICA / SPRINGBOARD DIVING		
1040500	Winner beli c/gabbia uzidni kavez dužina daske 1,70 m / white Winner 1,70 m	1.050,00 €
1040504	Winner svetlo plavi c/uzidni kavez dužina daske 1,70 m / light blue Winner 1,70 m	1.103,00 €
RICAMBI / REPLACEMENT		
1040501	Daska za zamenu 1,70 m bela / replacement white board 1,70 m	944,00 €
1040502	Daska za zamenu 1,70 m svetlo plava / replacement light blue board 1,70 m	944,00 €
1040509	Set šrafova za skakaonicu / kit screws for diving board	44,60 €
6000019	Kavez za skakaonicu Winner / Box to be build for Winner	141,50 €

SKAKAONICA ULISSE ULISSE SPRINGBOARD DIVING



U skladu normi EN 13451-10

Compliance with the standard EN 13451-10

Skakaonica od poliestera i Fiberglassa boja BELO. Na raspolaganju daska od smole dužine 1.80 m i širine 0.49 m. Oslonac od čelično anodizirane opruge. Uzidni kavez, pocinkovani zavtrnji.

Diving board in PE and glass fiber, colour white. Board in resin, length 1,80 m, width 0,49 m. Support by steel crossbow. Complete with box to be built, galvanized bolts.

Šifra /code	Opis /description	Cena/price
SKAKAONICA / SPRINGBOARD DIVING		
1040505	Ulisse dužina 1.80 m – h 0.25 m širina 0.49 m / Ulisse L 1,80-H0,25-W0,49m	1.085,00 €
REZERVNA DASKA / REPLACEMENT SPRINGBOARD DIVING		
1040507	Rezervna daska 1,80 m / replacement board 1,80 m	885,00 €

VODENI MLAZEVI WATER BLADES



*Moguće je kontrolisati VIŠE VODENIH MLAZNICA sa istom komandnom elektronskom tablom
It is possible to control several water blades using a single electrical panel

Da bi postigli skladan vodeni mlaz, neophodan je konstantni dotok vode. Zato je neophodno koristiti sferni ventil koji omogućava regulaciju dotoka vodenog mlaza.

To create a harmonious water blade, the water flow rate must be constant. Therefore necessary to use a ball valve which allows to adjust the flow rate of the water blade.

3 Dimenzije radi omogućavanja savršene jednoobraznosti u funkciji bazena ili odabrane spa. Vodeni mlazevi opremljeni LED svetlom sa naponom od 12V cc, pomoću elektro kutije (4) i njegovog daljinskog upravljača (uključen sa kutijom). Integriše 10 svetlosnih programa.

Available in 3 sizes to ensure a perfect fit in your pool or spa.

Water blades fitted with LEDs work off a 12 V DC supply via an electrical panel (4) and a remote control (included with the electrical panel). There are 10 light programmes to choose from.

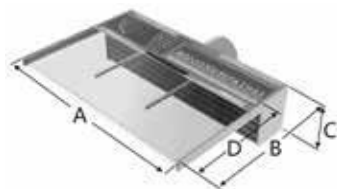

Šifra	A mm	B mm	C mm	D mm
1041170/73	306	263	76	150
1041171/74	606	263	76	150
1041172/75	1206	263	76	150

Šifra /code	Opis /description	Cena/price
VODENI MLAZEVI/ WATER BLADES		
1041170	Vodeni mlaz 300x150 mm / water blade 300x150 mm	200,30 €
1041171	Vodeni mlaz 600x150 mm / water blade 600x150 mm	349,30 €
1041172	Vodeni mlaz 1200x150 mm / water blade 1200x150 mm	571,70 €
VODENI MLAZ SALED / WATER BLADES WITH LED		
1041173	Vodeni mlaz sa LED da 4 W, 300x150 mm / water blade with 4W	292,80 €
1041174	Vodeni mlaz sa LED da 8 W, 600x150 mm / water blade with 8W	477,60 €
1041175	Vodeni mlaz sa LED da 16 W, 1200x150 mm / water blade with 16W LED 1200x150 mm	799,40 €
1041176	Razvodna tabla 60W, per lame d'acqua a LED* / electrical panel 60W for led water blade	436,90 €



cod.1041170

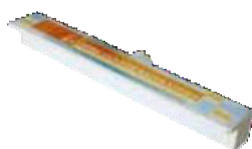

cod.1041171



cod.1041172



cod.1041176

VODOPADI

UKRASNI VODOPAD VESTA INOX 316 VESTA DECORATIVE WATERFALL 316 STAINLESS STEEL

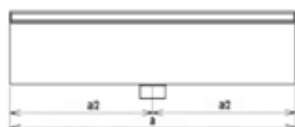
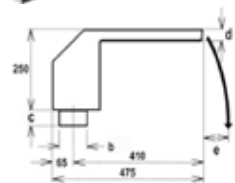

Šifra/ code	Opis/description	Cena/price
1041240	Ukrasni vodopad Vesta 300 / decorative waterfall Vesta 300	1.138,60 €
1041241	Ukrasni vodopad Vesta 500 / decorative waterfall Vesta 500	1.652,90 €

Šifra	Protok	A mm	B mm	C mm	D mm	E mm
1041240	10m ³ /h	300	2"	42	25	270
1041241	20m ³ /h	500	2"	42	25	250
1041245	40m ³ /h	1000	3"	48	25	260

VODOPAD MEZZA LUNA IOS INOX 316 – POTREBNO ANKERISANJE WATERFALL HALF-MOON IOS 316 STAINLESS STEEL - REQUIRED ANCHOR



Šifra/ code	Opis /description	Cena/ price
1041232	Vodopad mezzaluna polirani - inox 316 / polished waterfall los-316	3.173,00 €
1041233	Vodopad mezzaluna los mat - inox 316 / mattwaterfall los-316	2.768,10 €
1041226	Vodopad mezzaluna los elektr.polirana - inox 316 / electropolished waterfall los-316	2.857,90 €
1041277	Ram vodopada mezzaluna los polirana - inox 316 /frame for pol-ished waterfall los -316	304,50 €
1041278	Ram vodopada mezzaluna los mat - inox 316 / frame for pol-ished waterfall los-316	315,70 €
1041279	Ankerisanje vodopada mezzaluna los - inox 316 / anchor for water- fall los-316	375,90 €

Anker Ø	Protok m ³ /h
2"	30

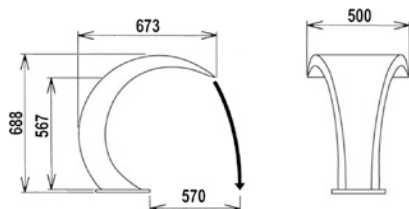

VODOPAD MINI IOS - INOX 304 BEZ ANKERISANJA MINI IOS WATERFALL - INOX 304 ANCHOR NOT REQUIRED



šifra / code	Opis/description	Ankeri Ø	Protok m ³ /h	Cena/ price
1041231	Vodopad Mini los polirani - inox 304 polished waterfall Mini los	1"1/2	20	1.716,10 €
1041224	Vodopad Mini los elektr.polirana - inox 304 electropolished waterfall Mini los	1"1/2	20	2.052,30 €

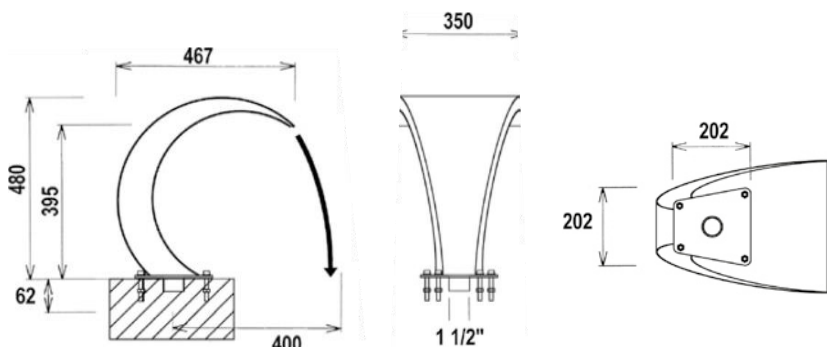

VODOPADI BOW E MINI BOW - INOX 316 SA ANKERISANJEM
BOW AND MINI BOW WATERFALLS - INOX 316 ANCHOR INCLUDED



Šifra / code	Opis /description	Cena/ price
1041380	Vodopad Bow polirana - inox 316 polished waterfall Bow	9.725,30 €
1041381	Vodopad Mini Bow polirani - inox 316 polished waterfall Mini Bow	5.547,10 €



Šifra	Ankeri Ø	Protok m³/h
1041380	1"1/2	20
1041381	1"1/2	12

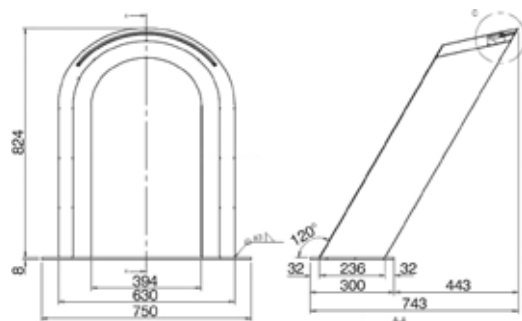

cod.1041380

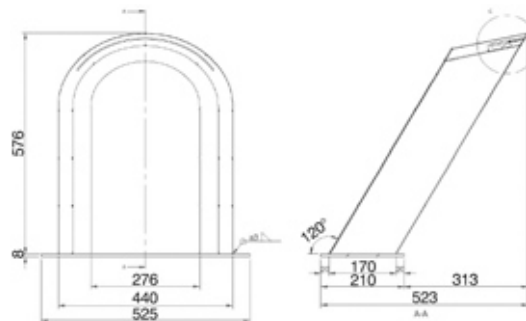

cod.1041381

VODOPAD FRAME ZIDNI - INOX 316 SA ANKERISANJEM
FRAME WALL WATERFALL - INOX 316 ANCHOR INCLUDED



Attacchi Ø	Portata m³/h
2"	10

ŠIFRA / code	Opis /description	Cena/ price
1041382	Vodopad Frame zidni polirani - inox 316 / polished waterfall Frame Wall	2.484,30 €

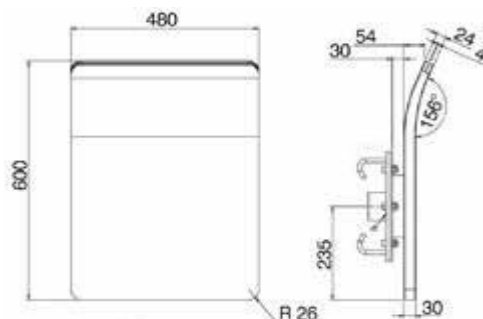

VODOPAD FRAME PODNI - INOX 316 BEZ ANKERISANJA
FRAME GROUND WATERFALL - INOX 316 ANCHOR NOT REQUIRED



Ankeri Ø	Protok m³/h
2"	10

ŠIFRA / code	Opis /description	Cena/ price
1041383	Vodopad Frame podni polirani - inox 316 / polished waterfall Frame Ground	2.336,60 €

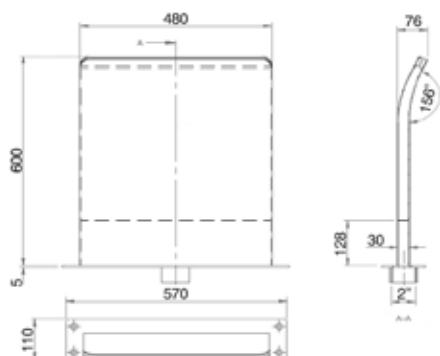

VODOPAD NINFA / NYMPH WATERFALL

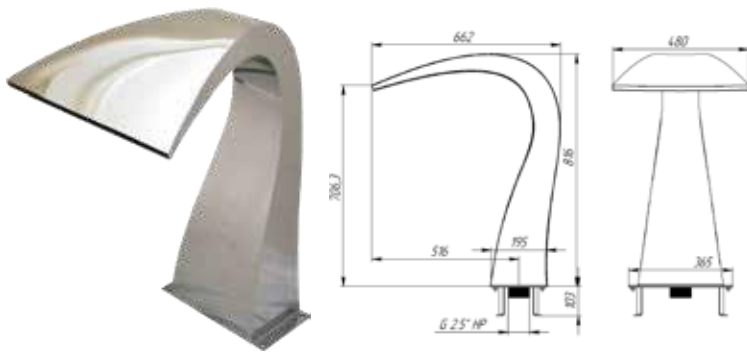

Šifra / code	Opis /description	Cena/ price
1041262	Vodopad ninfa - inox 304 Nymph waterfall stainless steel 304	3.611,60 €

Ankeri Ø	Protok m ³ /h
2"1/2	30

VODOPAD DELFINO / DOLPHIN WATERFALL

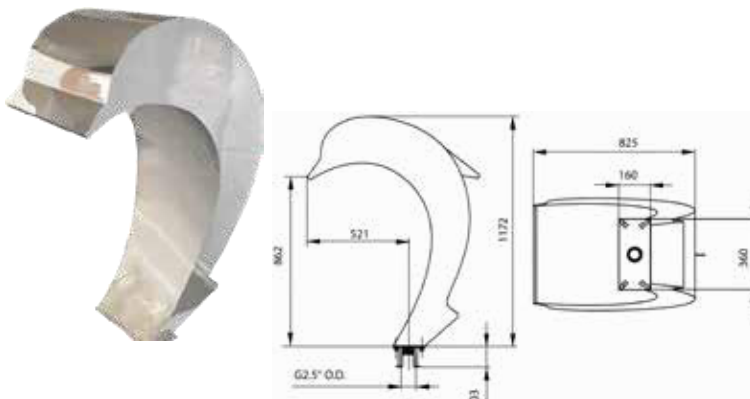

Šifra / code	Opis /description	Cena/ price
1041263	Vodopad delfino - inox 304 Dolphin waterfall stainless steel 304	7.208,00 €

Ankeri Ø	Protok m ³ /h
2"1/2	30

TOP ITHAKA INOX 316 / ITHAKA CANNON INOX 316

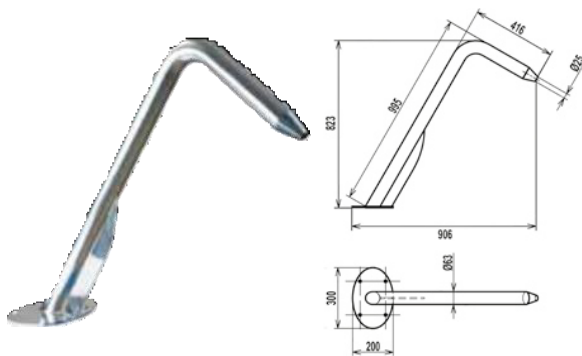

cod.1041264

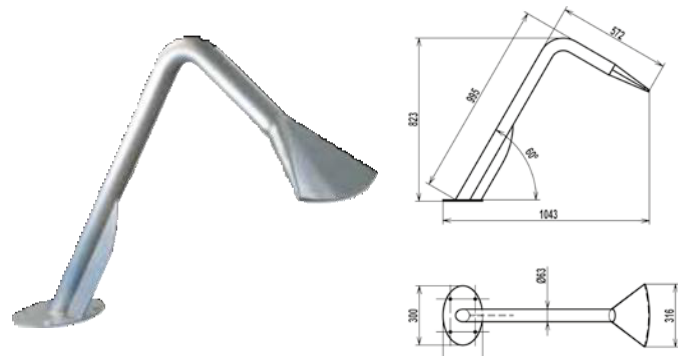

cod.1041265



cod.1041276

ŠIFRA/ code	Opis/description	Cena/ price
1041264	Top Ithaka – okrugla mlaznica polirana - inox 316 / Cannon Ithaka- circu- lar polished tip	1.064,80 €
1041265	Top Ithaka – ravna mlaznica polirana - inox 316 / Cannon Ithaka- flat polished tip	1.327,10 €
1041276	Ankerisanje topa Ithaka - inox 316 / anchor for cannon Ithaka	648,60 €

Spojevi Ø	Protok m ³ /h
2"	8

VODOPAD ANACONDA / ANACONDA WATERFALL

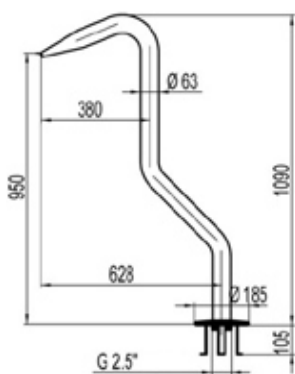

Šifra / code	Opis /description	Cena/ price
1041273	Vodopad anaconda - inox 304 Anaconda waterfall stainless steel 304	2.513,90 €

Spojevi Ø	Protok m ³ /h
2"1/2	15

VODENI TOP CORFU INOX 316 BEZ ANKERISANJA CORFU WATER CANNON INOX 316 ANCHOR NOT REQUIRED

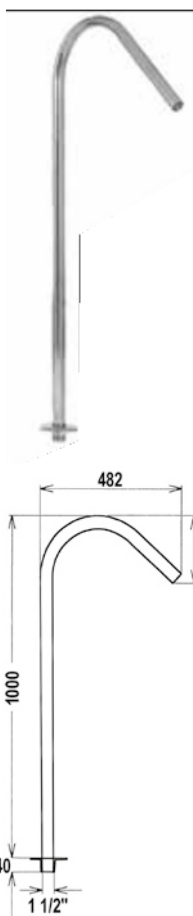

Mlaznica "A" stvara efekat širokog kružnog mlaza. Mlaznica "B" pravi efekat lakog pravog radijusa. Mlaznica "C" izbacuje vodu u 4 tanka reda usmerene u jednom pravcu. Mlaznica "D" izbacuje vodu u 6 tankih redova usmerene u kružnom mlazu.

The nozzle "A" creates the effect of a round broad spray. The nozzle "B" creates the effect of a right light beam. The nozzle "C" throws water in 4 rows of thin water collected in one direction. The nozzle "D" throws water in 6 files thin jet of water collected in a circular jet.

Šifra/ code	Opis/description	Ankeri Ø	Protok m ³ /h	Cena/ price
1041260	Top Corfu polirani - inox 316 /Corfu polished cannon-316 1"1/2 6	1"1/2	6	250,50 €



1041266

1041267

1041268

1041269

Šifra/ code	Opis/description	Cena/ price
1041266	Mlaznica A - inox 316 / nozzle A-316	161,50 €
1041267	Mlaznica B - inox 316 / nozzle B-316	158,90 €
1041268	Mlaznica C - inox 316 / nozzle C-316	162,60 €
1041269	Mlaznica D - inox 316 / nozzle D-316	163,40 €

ZIDNI VODENI MLAZ BRA - INOX 316 WATER JET WALL BRA 316 STAINLESS STEEL

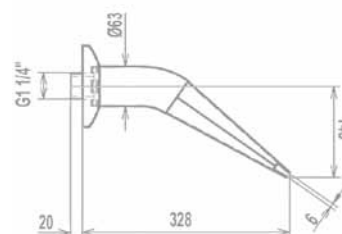

Šifra/ code	Opis/description	Ankeri/ Conne- tion Ø	Protok/ flow rate m ³ /h	Cena/ price
1041261	Zidni vodeni mlaz Bra - inox 316 / Bra wall water jet- 316 1"	1"1/2	6	790,90 €

ERCOLANO PEČURKA ZA JAVNI BAZEN
ERCOLANO FUNGUS FOR PUBLIC POOL



Pečurka realizovana kako za zabavutako i za pravu i istinsku masažu vrata pozicirajući je na odgovarajući način. Moguće je regulisati visinu pada vode zahtevajući potrebnu visinu u fazi narudžbe. Pečurka je realizovana od ojačanog poliestera sa fiberglassom i isporučuje se u kompletu sa: potpornom šipkom od PVC-PN 10 farbaņa, baznim ankerisanjem, prirubnicom i okovratnikom, šrafovi od čelika inox, od poliestera.

Fungus realized for entertainment and for a real cervical massage, positioning it in a suitable manner. It's possible to adjust the height of the fall of water seeking the desired height when ordering. The fungus is made of reinforced polyester with fiber glass and it is delivered complete with: support rod PN 10 PVC-coated, anchor base, flange and collar, stainless steel bolts, anchor covers in polyester.



cod.1041274

Šifra / code	Opis/description	Protok mlaza	Cena/ price
1041270	Ercolano Ø 1100, šipka 110 - Fungus Ø 1100, support rod Ø 110	40 m3/h	2.707,00 €
1041271	Ercolano Ø 1400, šipka 160 - Fungus Ø 1400, support rod Ø 160	40 m3/h	2.822,00 €
1041272	Ercolano Ø 1600, šipka 160 - Fungus Ø 1600, support rod Ø 160	40 m3/h	2.925,00 €
1041274	Ankerisanje Ercolano čelik inox 316 -Anchor fungus in 316 steel		1.344,00 €

SET ZA KOMPLETIRANJE OPREME ZA VODENI MLAŽ I FONTANA
KIT FOR COMPLETE SYSTEM WATER JET AND FOUNTAINS



SET pumpa i spojnice sastoji se od:

- pumpa ARCA
- Cev PVC tvrda, kolena, spojni adapteri i reduktori
- Mlaznica sa rešetkom od 2" o 3"

The pump and fittings kit consists of:

- ARCA pump
- Rigid PVC pipe, elbows, adapters and reductions fitting
- Nozzle with grid a 2" or 3"

Šifra / code	Opis /description	Protok mlaza m3/h	Cena/ price
1041280	Set pumpa i spojnice ARCA 550 mono/kit pump and fitting,ARCA 550 mono	12	293,00 €
1041281	Set pumpa i spojnice ARCA 550 tri / kit pump and fitting,ARCA 550 three	12	287,00 €
1041282	Set pumpa i spojnice ARCA 750 mono / kit pump and fitting,ARCA 750 mono	16	300,00 €
1041283	Set pumpa i spojnice ARCA 750 tri / kit pump and fitting,ARCA 750 three	16	294,00 €
1041284	Set pumpa i spojnice ARCA 1500A mono / kit pump and fitting,pump ARCA 1500A mono	24	577,0 €
1041285	Set pumpa i spojnice ARCA 1500A tri / kit pump and fitting,ARCA 1500A three	24	570,00 €
1041286	Set pumpa i spojnice ARCA 2200 mono / kit pump and fitting,ARCA 2200 mono	40	1.120,00 €
1041287	Set pumpa i spojnice ARCA 2200 tri / kit pump and fitting,ARCA 2200 three	40	1.113,00 €

MLAZNICA SA JEDNIM MLAZOM / SINGLE JET NOZZLE

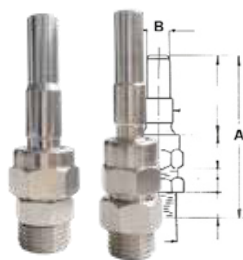

Usmerljiva vodena mlaznica od ABS. Usmerljiva mlaznica sa dugim i briljantnim mlazom vode. Velikog efekta, kako sa korišćenjem jedne mlaznice, tako i grupe kružnog oblika ili u redu. Zahvaljujući svojoj usmerljivoj konstrukciji može se pozicionirati sa uglom od 15°.

Baza od bronce prekrivena hromiranim mesingom.

Water nozzle adjustable in ABS. Adjustable nozzle that forms a long and bright jet of water. Of great effect, whether it is used a single nozzle, in group or circular in a row. Thanks to its adjustable construction it can be positioned at an angle of 15°.

Šifra / code	Opis/description	Cena/ price
1041401	Mlaznica sa jednim mlazom ASB-140	10,50 €
1041403	Mlaznica sa jednim mlazom ASB-381	16,70 €
1041404	Mlaznica sa jednim mlazom ASB-120	26,20 €



Šifra	Spoj	A mm	B mm	H [m.c.a.]	Q [l/min]	H Mlaz [m]
1041401	1/4"	65	4	5/15,2	8/25	1-4
1041403	3/8"	72	6	5/15,2	25/50	1-6
1041404	1/2"	72	6	5/15,2	25/50	1-6

VIŠESTRUKA MLAZNICA SA USMERLJIVIM MLAZOM



Usmerljiv verzija višestruke mlaznice omogućava izvanredan učinak u bazenima velikih dimenzija i idealan je za velike unutrašnje i spoljne prostore.

Ugaono postavljene mlaznice proizvode mlaz usmeren prema spoljašnosti. Bronzana baza a prekrivena hromiranim mesingom.

The adjustable version of the multi-jet provides excellent performance in large pools and it is ideal for large indoor and outdoor spaces. The spouts positioned angularly produce a jet oriented towards the outside. The base is in bronze and has a plated brass coating.

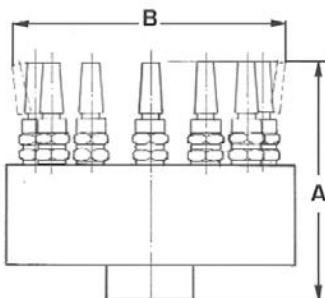

Šifra/ code	Opis /description	Cena/ price	Ulaz	A mm	B mm
1041416	Mlaznica sa višestrukim mlazom ADL-100	418,20 €	1/2"	85	100
1041417	Mlaznica sa višestrukim mlazom ADL-135	499,00 €	1 1/4"	95	135
1041418	Mlaznica sa višestrukim mlazom ADL-210	1.188,00 €	1 1/4"	140	210
1041419	Mlaznica sa višestrukim mlazom ADL-275	1.829,60 €	2"	230	260
1041420	Mlaznica sa višestrukim mlazom ADL-300	2.246,00 €	3"	230	260
1041421	Mlaznica sa višestrukim mlazom ADL-340	2.699,20 €	4"	230	260

U dole navedenoj tabeli, traženi protok vode je označen slovom Q.

In the following table, the required water flow is indicated by the letter Q.



Šifra	H	Q	H	Q	H	Q	H	Q	H	Q	H	Q	H	Q
1041416	1,6 m	20 l/min	2,8 m	30 l/min	4 m	10 l/min	-	-	-	-	-	-	-	-
1041417	2 m	50 l/min	3,8 m	70 l/min	5 m	85 l/min	7,8 m	115 l/min	-	-	-	-	-	-
1041418	2,1 m	120 l/min	3,2 m	200 l/min	4,8 m	280 l/min	6,2 m	340 l/min	7,5 m	420 l/min	-	-	-	-
1041419	4 m	14 m³/h	6 m	18 m³/h	8,5 m	24 m³/h	11 m	28 m³/h	-	-	-	-	-	-
1041420	-	-	5 m	20 m³/h	7 m	22 m³/h	8 m	28 m³/h	9 m	32 m³/h	10 m	36 m³/h	12 m	44 m³/h
1041421	-	-	-	-	14 m	20 m³/h	17 m	23 m³/h	19 m	26 m³/h	22 m	28 m³/h	26 m	34 m³/h

HIDROMASAŽA

ACQUA BUBBLE OKRUGLI / ROUND WATER BUBBLE

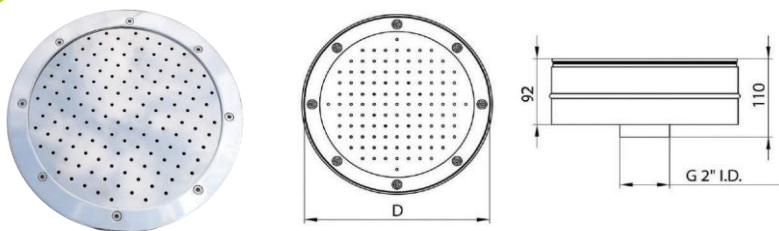

Uređaj za vazdušnu hidromasažu realizovan od čelika inox 304.

Device for hydromassage with air made of stainless steel 304.

Šifra / code	Opis /description	D [mm]	Protok [m3/h]	cena/ price
1073009	Acqua Bubble Ø 310 – donji spoj 2" F za podlogu - čelik inox 304 Acqua Bubble Ø 310 - lower connection 2" F for liner - stainless steel 304	310	50	862,40 €
1073010	Acqua Bubble Ø 420 – donji spoj 2" F za podlogu - čelik inox 304 Acqua Bubble Ø 420 - lower connection 2" F for liner - stainless steel 304	420	50	1.369,20 €

ACQUA BUBBLE ČETVRTASTI / SQUARE WATER BUBBLE

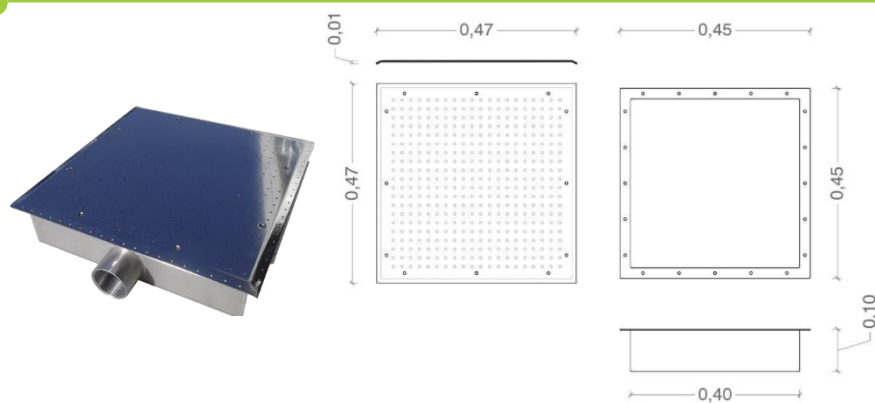

Uređaj za vazdušnu hidromasažu realizovan od čelika inox AISI 316 sa unutrašnjim uređajem za regulisanje protoka vazduha.

Device for air whirlpool made of stainless steel AISI 316 and purpose of the internal control air flow.

Šifra / code	Opis /description	Cena/ price
1041225	Acqua Bubble 400x400 – priključak 2" for liner - čelik inox AISI 316 Acqua Bubble 400x400 - 2" liner connection - stainless steel AISI 316	1.190,00 €

SET HIDROMASAŽE ACQUA BUBBLE / WATER BUBBLE WHIRLPOOL KIT

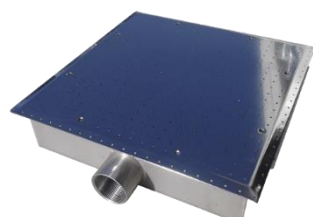

SET SE SASTOJI OD :
THE KIT CONSISTS OF:

- Acqua bubble 400x400 trofazni za lajner
- Duvaljka od 0,90 kW kontinuiranog rada
- Spojnice za povezivanje Ø 63
- Lepak za spojnice
- Cev PVC tvrda Ø 63
- Water bubble 400x400 threephase for liner
- The blower from 0.90 kW
- The connection pipes Ø 63
- The glue for the fittings
- Rigid PVC pipe Ø 63



Šifra / code	Opis /description	cena/ price
1030177	Set Acqua bubble 400x400 za lajner Kit Acqua bubble 400x400 forliner	2.117,00 €

SET PUMPA I DUVALJKE / PUMP AND BLOWERS KIT

Set pumpa i duvaljka u sastavu: pumpa BRETON 750 bez predfiltera, kompresor duvaljka 900 W, tabla sa transduktorom, mlaznica sa rešetkom 2" C-319, fleksibilna cev, fitting i lepak.

Kit pump and blower with: pump BRETON 750 without prefilter, blower 900 W, control panel with pneumatic transducer, return fitting with grid 2" C-319, flexible tube, fittings and glue.

Šifra / code	Opis /description	Cena/ price
5010087	Set pumpa i duvaljka / kit pump and blower	1.336,00 €



**VODOPADI DOPRINOSE
U DAVANJU JEDNOG
JEDINSTVENOG I
POSEBNOG OBELEŽJA
BAZENU KREIRAJUĆI
I LEP EFEKAT MASAŽE
I HIDROTERAPIJE**

**WATERFALLS CONTRIBUTE A
UNIQUE AND SPECIAL TOUCH TO THE
POOL ALSO CREATING A PLEASANT
MASSAGE AND
HYDROTHERAPY EFFECT**

str. 350

VODOPAD MINI IOS

MINI IOS WATERFALL

Covers

PREKRIVKE

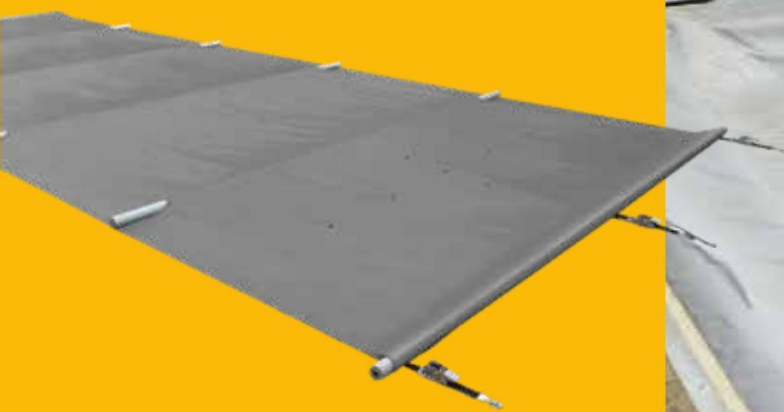

8

Sadržaj

ROLETNA PREKRIVKE / SHUTTER COVERS

- 364 ROLLENERGY EVOLUTION
- 367 ROLLIN
- 371 PEDANA COPRI VANO PER COPERTURE IMMERSA / FOOTBOARD COMPARTMENT COVER FOR IMMERSED COVERINGS
- 371 SECURYWALL PER FONDO PIATTO / SECURYWALL FOR FLAT BOTTOM
- 372 ROLLINSIDE
- 377 ROLLEASY 2
- 381 CONTURA
- 384 ROLLOVER
- 387 MOOVE'O SOLARE
- 389 LAMELE / SLATS

AUTOMATSKE PREKRIVKE / AUTOMATIC COVERS

- 391 SAFETY COVER / SAFETY COVER

PREKRIVKE SA ŠIPKAMA / BARS COVERS

- 393 CLASSIC B-1.1
- 394 PREMIUM B-2.1
- 396 COVERKIT

ZIMSKA PREKRIVKE

- 397 OJAČANA ZIMSKA PREKRIVKA / WINTER COVER REINFORCED
- 398 ZIMSKA PREKRIVKA PVC / WINTER COVER PVC
- 399 ECOMREŽA ELTEX / ECONET ELTEX
- 399 ANTIFRIZ PLOVCI / ANTIFREEZE FLOATERS
- 399 OPREMA PREKRIVKI / COVERS ACCESSORIES
- 400 ANTIFRIZ ČEPOVI / DEFROST CAP
- 400 POTOPNE PUMPE / SUBMERSIBLE PUMPS

IZOTERMIČKE LETNJE PREKRIVKE / SUMMER ISOTHERMIC COVER

- 401 ULTRA LAKA SA MEHURIĆIMA / ULTRA LIGHT WITH BUBBLES
- 401 LETNJA PREKRIVKA SA MEHURIĆIMA / SUMMER COVER WITH BUBBLES
- 401 A MOUSSE / MOUSSE COVER

MOTALICE/ REELS

- 402 VELA
- 402 OMEGA
- 403 ARIONE E REEL

ROLETNA PREKRIVKE-POTOPLJENE
SHUTTERCOVERS-UNDERWATER

ROLLENERGY EVOLUTION

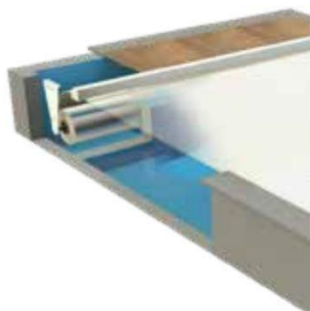

Sve vrste bazena
 da 2,5 x 3 m a 8 x 15 m
 scala Ø 3 m

motori:

1 20 Nm o 250 Nm

ROLLIN

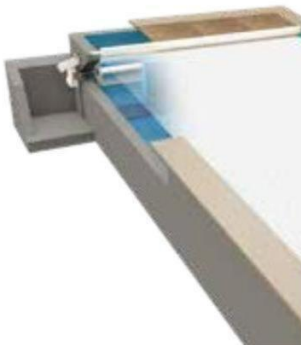

Za velike bazene
 da 2,5 x 3 m a 10 x 25 m
 scala Ø 3 m

motori:

120 Nm, 250 Nm o 500 Nm

Automatski prekidač
Serijski do 8 x 12 m

SECURIWALL

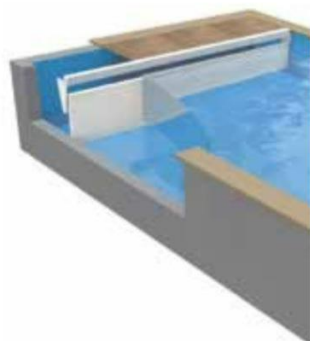

Dodatak za rolleenergy e
 rollin

za sve vrste podova

dubina do 2,07m
širina do 7,07m

boje na raspolaganju:



ROLLINSIDE

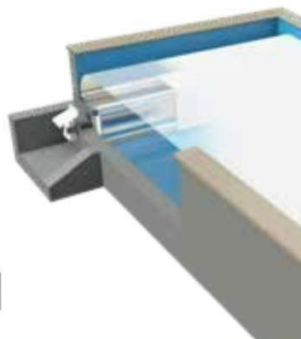

sa unutrašnjim kućištem

širina 1 stranica
 do 10 m **širina**
dve stranice do
 6 m

motori:

120 Nm o 250 Nm

ROLETNA PREKRIVKA-NADZEMNA
SHUTTER COVERS - ABOVE GROUND

ROLLEASY 2

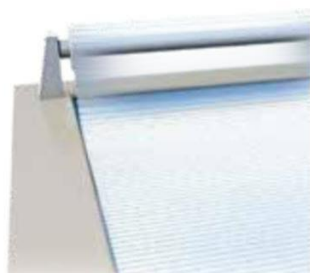

Sve vrste bazena
 da 2,5 x 3 m a 8 x 16 m
 scala Ø 3 m

verzije:

električna, ručna i
 solarna (fino a 5 x 11 m)

personalizovani terminalii:



CONTURA



Sve vrste bazena
 da 2,5 x 3 m a 10 x 18 m

verzije:

električna, solarna

vratio sa ležajevima

ROLL OVER

**finiš u PVC**

da 2,5 x 3 m a 6 x 14 m

finiš u drvetu IPÈ

da 2,5 x 3 m a 7 x 10 m

verzije:

električna, solarna

solarne verzije dvobojne



MOOVE ' O SOLARE



bazen slobodnog oblika
 da 2,5 x 3 m a 5 x 11 m

bez šina

boje na raspolaganju:

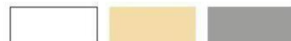

AUTOMATSKA PREKRIVKA AUTOMATIC COVER

SAFETY COVER



Za nove ili postojeće bazene

konfiguracije:

- A. Nadzemno kućište motora sa nadvičnim vođicama
- B. Kućište motora u zemlji sa nadzemnim vođicama
- C. Uzemčjeno kućište motora sa vođicama ispod ivice



PREKRIVKE SA ŠIPKAMA BAR COVERS

CLASSIC B-1.1



Zaštita od vode leti i zimi

Maksim. dim.prekrivke 5,50x12,50m
skala max 4 x 2 m
pozicioniranje sa 3 tačke zatezanja



PREMIUM B-2.1



Zaštita od vode leti i zimi

Maks.dim.prekrivke 6 x 12 m
skala max 4 x 2 m
remani u harmoniji sa bojom prekrivke



ZIMSKE PREKRIVKE WINTER COVERS



Modeli na raspolaganje:

zimski prekrivka
geomembrana sintetička od pojačanog polietilena, masa areična: 210 o 240 g/m²

Pvc prekrivka
geomembrana sintetička od poliestera premazano PVC, otporno na cepanje tretirano na ultraviolektne zrake

Ecomreža Eltex
Platno mreže otporno na prljavštinu i sunce

IZOTERMIČKE LETNJE PREKRIVKE SUMMER ISOTHERMIC COVERS



Modeli na raspolaganje:

sa mehurićima
debljina 400 micron stabilizovan UV zracima sa duplim listom polietilena

ultra laki mehurići
debljina 400 micron tretirano protiv UV

mousse prekrivke
debljine 6 mm za grejane bazene geosintetičke, nepromočive i izolovane

ROLLENERGY EVOLUTION



Prekrivka ROLLENERGY EVOLUTION odgovara svim vrstama bazena, u izgradnji ili koji se obnavljaju, od 2x3m do 8x15,50m + stepenice Ø 3m. Ne zahteva strukturalne radove, obezbeđujući brzo instaliranje zahvaljujući ploči za fiksiranje koja olakšava prolaz kabla. Cevasti vodootporni motor potopljen 120 Nm o 250 Nm prema Dimenzijama bazena. Kablo za napajanje robusno, kolektori graničnika otporni i neosetljivi na gromove pojednostavljenom kablazom.

The ROLLENERGY EVOLUTION cover is suitable for all types of pools, in construction and renovation, from 2x3 m up to 8x15,50 m + stair Ø 3 m. It does not require structural work, ensuring rapid installation thanks to the fixing plate which facilitates the passage of the cable. Waterproof immersed tubular motor 120 Nm or 250 Nm depending on the pool size. Sturdy power cable, resistant and insensitive to lightning collectors of limit switch with simplified wiring.

KARAKTERISTIKE

1. **PLOČA**
 - Debljina 12 mm
 - Prolazni široki otvor del kabla sa štitnikom kabla
 - Isporučena sa šablonom za bušenje
 - Mala specijalna ploča za bazene od fiberglasa
- **MOTORIZACIJA**
2. Potopljeni cevni električni motor sa graničnikom podesivi
 - Električna komandna tabla 230 volts
 - Automatski prekidač: štampano kolo koje omogućava stopiranje otvaranja u slučaju da se primeti neuobičajeno naprezanje na prekrivci
 - Rukovanje putem ključa ili Wi-Key
 - Kabložno kablo standard od 3,00 m
- **VRATILO OD ALUMINIJUMA ANODIZIRANO 20 MICRONS**
3. **ALUMINIJUMSKA GREDA**
4. **3 boje: belo, pesak ili sivo**
- **LAMELE**
5. LamELE PVC MAT ILI poliKarbonat solarni
- **GAZNA REŠETKA**
- 6.
7. **KOMPLET KAČENJA**
 - Pushlock

FEATURES:

1. **PLATE**
 - Thickness 12 mm
 - Wide slit of cable passage with protective cable cover
 - Delivered with a template for the hole
 - Special small plate for fiberglass pools
2. **MOTORIZATION**
 - Tubular motor immersed electric with adjustable limit switch.
 - Electric control panel 230 volts.
 - Automatic switch: printed circuit that allows to stop the cover after detection of anomalous stress on the cover.
 - **Control by box key or Wi-Key**
 - Standard 3.00 m wiring cable
3. **ANODIZED ALUMINIUM POLE 20 MICRONS**
4. **ALUMINIUM BEAM**
 - 3 colours: white, sand or grey
5. **SLATS**
 - PVC opaque slats or polycarbonate solar
6. **DUCKBOARDING**
7. **HOOKING KIT**
 - Pushlock

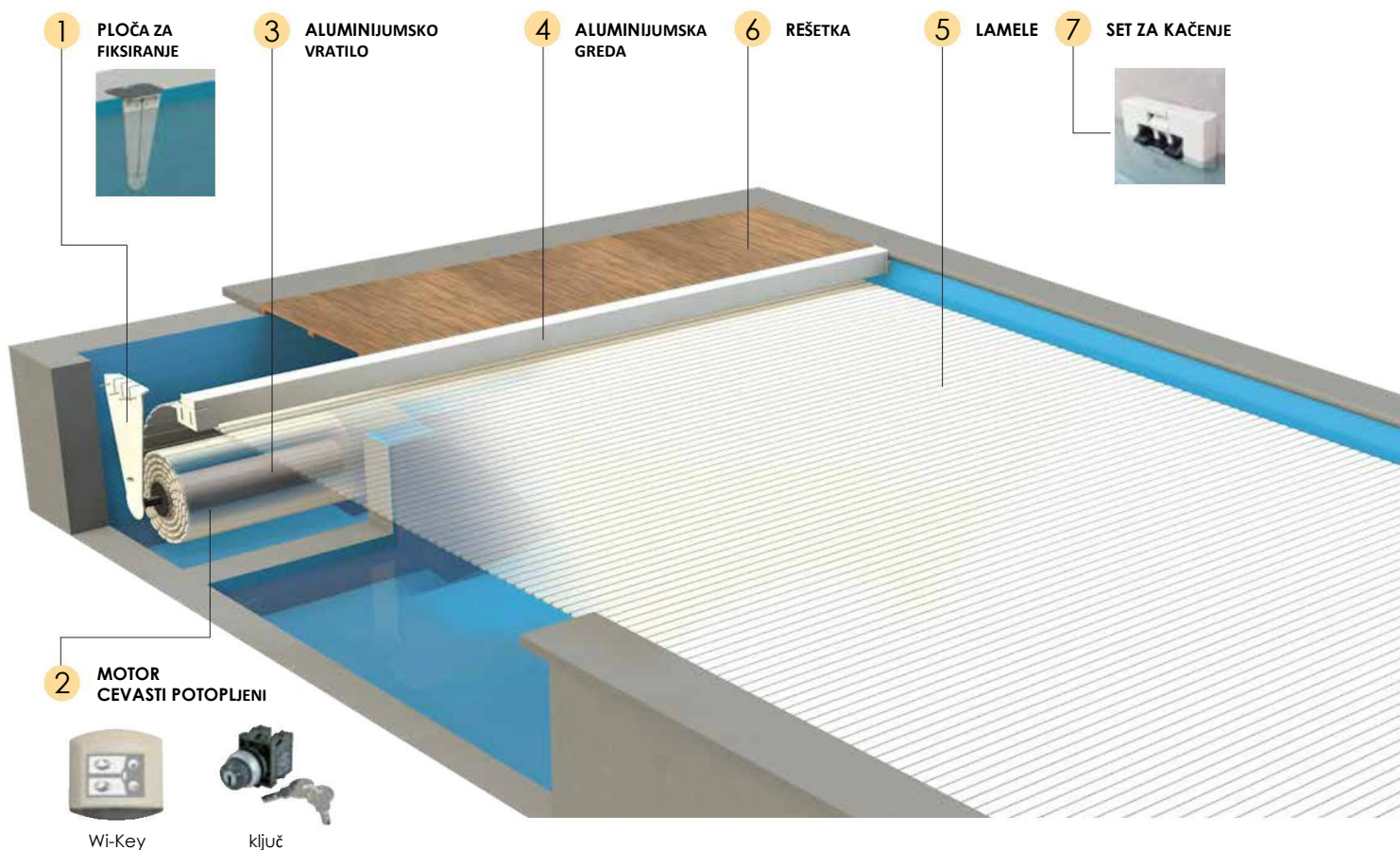

SET ROLETNA MODEL ROLLENERGY EVOLUTION

Komplet roletni treba uzeti u standardnoj formuli: mehanika, lameprekrivke u bojama belo/pesak/sivo/uzidna greda 120x100 mm, sigurnosni keripushlock na rideru; rešetka koja prekriva odeljak za roletne nije uključena u standardni komplet.

Roller shutter kit in the standard formula: mechanical, cover blades in white / sand / gray, 120x100 mm beam to be walled in, pushlock safety hooks to rider; the grating covering the roller shutter compartment is excluded from the standard kit

opis (bez grede)*	šifra	cena	opis (sa gredom)*	šifra	cena
Roletna za bazen 7,00 x 3,00 m	5060370	14.004,00 €	Roletna za bazen 7,00 x 3,00 m	5060377	14.016,00 €
Roletna za bazen 8,00 x 4,00 m	5060371	17.916,00 €	Roletna za bazen 8,00 x 4,00 m	5060378	15.485,00 €
Roletna za bazen 9,00 x 4,00 m	5060372	18.303,00 €	Roletna za bazen 9,00 x 4,00 m	5060379	15.833,00 €
Roletna za bazen 10,00 x 4,00 m	5060373	18.689,00 €	Roletna za bazen 10,00 x 4,00 m	5060380	15.863,00 €
Roletna za bazen 10,00 x 5,00 m	5060374	19.861,00 €	Roletna za bazen 10,00 x 5,00 m	5060381	19.945,00 €
Roletna za bazen 12,00 x 5,00 m	5060375	20.833,00 €	Roletna za bazen 12,00 x 5,00 m	5060382	20.820,00 €
Roletna za bazen 12,00 x 6,00 m	5060376	22.883,00 €	Roletna za bazen 12,00 x 6,00 m	5060383	22.995,00 €
Opcija scala romana			šifra	cena	
Rimske stepenice Ø do 3,00 m sa lamelama PVC belo mat			5060076	672,70 €	
Rimske stepenice Ø do 3,00 m sa lamelama PVC pesak mat			5060077	672,70 €	
Rimske stepenice Ø do 3,00 m sa lamelama PVC mat sivo			5060078	672,70 €	

* Mere se odnose na unutrašnje dimenzije bazena, isključujući dimenziju otvora roletne

* The measurements refer to the internal dimensions of the pool, excluding the dimension of the shutter compartment.

ZADODATNE MODELE STEPENICAPOGLEDAJTE TABLICUNA DNUDELJKA ROLETNA PREKRIVKI
FOR FURTHER STAIRS MODELS, SEE TABLE AT THE BOTTOM OF THE SHUTTER COVERS CHAPTER

OPCIJE / OPTIONS



PRIKLJUČNA KUTIJA

Permette di connettere il motore e il quadro elettrico
TELESKOPSKI MEĐUNOSAČ

Za rešetke max do 90 cm, neophodan za grede 100x100 većih od 5,10 m širine i 120x100 većih od 6,10 m širine.

CONNECTION BOX

It allows to connect the motor and the electrical panel
TELESKOPIC INTERMEDIATE SUPPORT

duckboarding max 90 cm, essential for beams 100x100 more than 5.10 m wide, and 120x100 more than 6,10 m wide

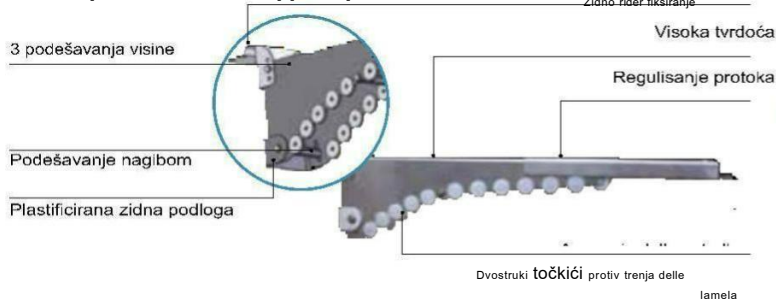
Teleskopski srednji nosač od 8 m
Telescopic intermediate support up to 8 mSpojni nosač grede od 8 do 10 m
Connection support for beams from 8 to 10 m

Šifra/code	Opcije Rolleenergy	Cena/price
5 061000	Priključna kutija / connection box	64,20 €
5 061002	Odašiljač Wi-Key dodatni – omogućuje instalaciju max 3 odašiljača po prijemniku Additional transmitter Wi-KEY - it allows to install max 3 transmitters for every receptor	422,50 €
5061003	Ploča daljinskog receptora Wi-Key – Potreban ako je odašiljač instaliran na mestu jako udaljenom od prijemnika ili ko neka zgrada ometa prolaz radio talasa Remote panel receptor Wi-Key - necessary if the transmitter is installed in a place very far from the receiver or if a building disturbs the passage of radio waves	169,50 €
5061004	Set za adaptaciju Wi-Key (prelazak sa kutije sa ključem na Wi-key) - Adaptation kit Wi-Key (evolution from key box to Wi-Key)	1.076,60 €
5061005	Teleskopski srednji nosač za grede, prostor od 91 do 105 cm Telescopic intermediate support for beams, compartment from 91 to 105 cm	Do 8 m up to 8 m 1.020,80 €
5061006	Teleskoski srednji nosač za grede, prostor od 91 do 105 cm Telescopic intermediate support for beams, compartment from 91 to 105 cm	Do 10 m up to 10 m 2.917,10 €
5060111	Kablo za ožičenje motora - 15 m Cable for motor wiring - 15 m	494,30 €

**ROLLENERGY
EVOLUTION**

▶ ZA OBRAČUN FINALNE CENE
TO CALCULATE THE FINAL PRICE

▶ 1 + 2 + 3 + 4 + 5

Codice /code	2,00x23,50	2,50x23,50	3,00x23,50	4,00x17,00	4,00x22,00	4,5x21,00	5,00x10,50	5,00x15,50	6,00x17,00	7,00x17,50	8,00x15,50	
1 MEHANIKA / mechanics	120Nm	120Nm	120Nm	120Nm	250Nm	250Nm	120Nm	250Nm	250Nm	250Nm	250Nm	
Ø osovine/ axis	Ø 140 mm								Ø 180 mm			
Vratilo, motor i nosači /pole, motor and rider plates	5060567	5060568	5060569	5060000	5060001	5060002	5060003	5060004	5060005	5060006	5060007	
	9.032,20€	9.179,60€	9.361,70€	9.548,10€	11.653,30€	11.828,80€	9.885,30€	11.931,80€	12.682,60€	15.445,00€	16.827,80€	
2 LAMELE / slats: CENU MNOŽITI SA DUŽINOM BAZENA / PRICE TO MULTIPLE FOR THE LENGTH OF THE POOL												
Mere lamele do metara	2,00	2,50	3,00	4,00	4,00	4,50	5,00	5,00	6,00	7,00	8,00	
Lamele PVC belo mat /White opaque PVC slats	5060562	5060572	5060008	5060009	5060009	5060010	5060011	5060011	5060013	5060014	5060015	
Lamele PVC pesak mat /Sand opaque PVC slats	5060563	5060573	5060016	5060017	5060017	5060018	5060019	5060019	5060021	5060022	5060023	
Lamele PVC mat sivo /Grey opaque PVC slats	5060564	5060574	5060024	5060025	5060025	5060026	5060027	5060027	5060029	5060030	5060031	
cena/price	249,30 €	257,70 €	264,20 €	347,80 €	347,80 €	387,20 €	437,60 €	437,60 €	509,50 €	564,00 €	633,10 €	
Lamele PVC sv.plavo mat /Light blue opaque PVC slats	5060565	5060575	5060032	5060582	5060582	5060034	5060035	5060035	5060037	5060038	5060039	
Cena/price	258,00 €	269,60 €	276,60 €	415,40 €	415,40 €	442,30 €	480,90 €	480,90 €	532,30 €	602,70 €	674,10 €	
Lamele L84 PVC belo ili Mat sivo / L84 PVC slats white or gray matte	5060585	5060586	5060587	5060589	5060589	5060590	5060591	5060591	-	-	-	
Cena/price	205,30 €	225,20 €	237,90 €	313,00 €	313,00 €	348,50 €	393,90 €	393,90 €	-	-	-	
Lamele pokicarbonat solarni /Polycarbonate solar slats	5060566	5060576	5060046	5060047	5060047	5060584	5060049	5060049	5060051	5060143	5060144	
Cena/price	698,60 €	790,50 €	878,20 €	1.074,10 €	1.074,10 €	1.283,20 €	1.350,80 €	1.350,80 €	1.632,20 €	1.898,80 €	2.175,40 €	
3 SETA ZA KAČENJE PUSHLOCK / Pushlock coupling kit CENU MNOŽITI SA BROJEM DODELJENIH KOMADA / Price to be multiplied by the number of pieces assigned												
Zidni / to wall	5061010											
Cena po kom/ single price	91,00 €											
Količina / quantity	2	2	2	3	3	3	3	3	4	4	5	
Nosač / rider Visoki nosač / high rider Cena po komadu/ single price	5061011 5061012 162,80 €											
Količina / quantity	2	2	2	3	3	3	3	3	4	4	5	
4 KUTIJE OSILONCI GREDA / beam support												
ZIDNI to wall	5060058 318,00 €											
Ravni nosač podesivi flat adjustable rider	5060059 520,80 €											
5 greda/ beams: KAKO IZABRATI GREDU Vd. p. 368* / HOW TO CHOOSE THE BEAM SEE p.368* (CENE SE ODNOSE NA BELU BOJU /prices refer to the colour white)												
zidni / to wall 100x100 mm	5060570	5060571	5060577	5060060	5060060	5060578	5060061	5060061	5060062**	5060063**	5060579**	
	1.028,10€	1.173,80€	1.289,40€	1.316,40€	1.316,40€	1.471,60€	1.514,40€	1.514,40€	2.594,60€	3.297,90€	4.327,50€	
zidni / to wall 120x100 mm	5060580	5060581	5060598	5060064	5060064	5060465	5060065	5060065	5060066	Konsultujte nas consult us		
	1.107,30€	1.180,10€	1.338,50€	1.441,50€	1.441,50€	1.813,70€	1.834,30€	1.834,30€	2.160,60€			
nosač / rider 100x100 mm	5060599	5060600	5060601	5060068	5060068	5060602	5060069	5060069	5060070**	5060071**	5060603**	
	790,50€	939,40€	1.047,10€	1.067,70€	1.067,70€	1.356,00€	1.427,20€	1.427,20€	2.512,30€	3.218,70€	4.147,00€	
nosač / rider 120x100 mm	5060604	5060605	5060606	5060072	5060072	5060607	5060073	5060073	5060074	konsultujte nas consult us		
	869,70€	942,50€	1.100,90€	1.203,90€	1.203,90€	1.576,10€	1.596,70€	1.596,70€	1.923,00€			

* Za dodatne grede veće od 6,00 m (pesak i sive) kontaktirajte nas. Cene po meri. For further beams larger than 6.00 m (sand and grey) please consult us. Customised prices.

**Za šifre: 5060062, 5060063, 5060579, 5060070, 5060071, 5060603 uračunat u cenu posredni teleskopski nosač/ Price included the telescopic intermediate support

ROLLIN



Prekrivka ROLLIN osmišljena posebno za velike bazene prilagodljiva je za bazene 2x3 m do 10x16,50. Zahvaljujući motoru instaliranom u suvom prostoru pored bazena, olakšana su održavanje i popravke. Serijski automatski prekidač do 8x14,50 m

The ROLLIN cover conceived especially for large pools fits pools 2x3 m up to 10x16,50. Thanks to the motor installed in a dry box beside the pool, maintenance and repairs are facilitated. Automatic switch standard up to 8x14,50 m

KARAKTERISTIKE

1. **MOTORIZZAZIONE**

- Motor sa mehaničkim graničnikom: motori 120 i 250 Nm. Niski napon 24 Vcc, niska potrošnja i značajan par motora
 - Motor sa električnim graničnikom: motor 500 Nm. Upravljanje preko mikropcesora sa konfiniranim napajanjem od 24 V. Upravljanje graničnim prekidačem preko magnetskog senzora u motoru. Programiranje upravljanja na električnom panelu
 - Električna tabla sa magnetno-termičkim osiguračem koji obezbeđuje zaštitu motoreduktora (za motore motore 120 i 250 Nm, osigurač za motore 500 Nm)
 - Električna tabla sa elektronskom programiranom tablom graničnika preko prekidača (motor sa elektronskim upravljanjem 500Nm)
 - Automatski prekidač: štampano kolo koje omogućava zaustavljanje otvaranja u slučaju da se detektuju neuobičajena dejstva na sistemima za kačenje (za motore 120 i 250 Nm)
 - Upravljanje sa ključem ili Wi-Key
2. **Komadi** za zidanje
- Debljina zida od 20 do 26 cm (ostale dimenzije po zahtevu)
 - Ako je širina bazena veća od 8 m: osovina Ø 45 mm
3. **ALUMINIJUMSKE ELOKSIRANI KARDAN 20 MICRONS**
4. **ALUMINIJUMSKA GREDA**
- 3 BOJE: bela, pesak ili siva
5. **LAMELE**
- Lamele PVC mat ili solarni polikarbonat
6. **REŠETKA**
7. **SET ZA KAČENJE**
- Pushlock

FEATURES:

1. **MOTORIZATION**

- Motor with mechanical management of the limit switches: motors 120 and 250 Nm. Low voltage 24 VDC, low consumption and important engine torque.
 - Electronically controlled engine of the limit switches: motor 500 Nm. Control by microprocessor powered at 24 V continuous. Management of the limit switches by a magnetic sensor in the motor. Programming of the command in the electrical panel. Electric panel with magneto-thermal circuit breaker which ensures gearmotor protection (for motor 120 and 250 Nm, fuse for motor 500 Nm)
 - Electric panel with programmable electronic limit switch by push button (electronically controlled motor 500Nm)
 - Automatic switch: printed circuit that allows to stop the cover after detection of anomalous stress on the chooking systems (for motors 120 and 250 Nm).
 - Control by box key or Wi-Key
2. **PIECES TO WALL**
- Wall thickness from 20 to 26 cm (other dimensions on request)
 - If the width of the pool is more than 8 m: axis of Ø 45 mm
3. **ANODIZED ALUMINIUM POLE 20 MICRONS**
4. **ALUMINIUM BEAM**
- 3 colours: white, sand or grey
5. **SLATS**
- PVC opaque slats or polycarbonate solar
6. **DUCKBOARDING**
7. **HOOKING KIT**
- Pushlock

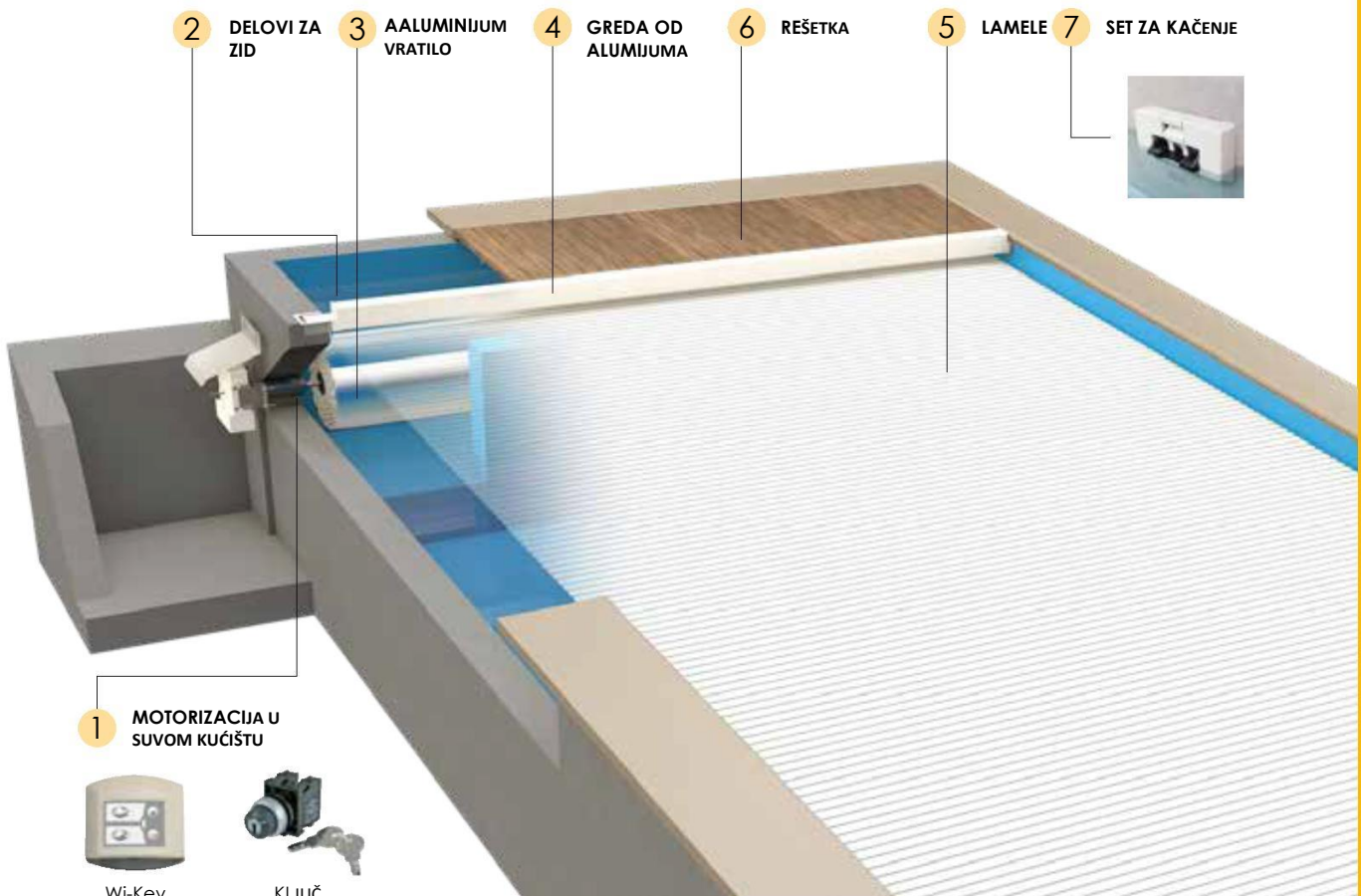

SET ROLETNA MODEL ROLLIN STANDARD

KOMPLET za roletne treba razumeti u standardnoj formuli: **mehanička**, lamele prekrivke u bojama bela/pesak/sivo, uzidna greda 120x100 mm, sigurnosne kukice pushlock rider; **isključena** iz standardnog kompleta **rešetka** koja pokriva **kućište** roletne.

Roller shutter kit in the standard formula: mechanical, cover blades in white / sand / gray, 120x100 mm beam to be walled in, pushlock safety hooks to rider; the grating covering the roller shutter compartment is excluded from the standard kit.

opis (senza putrella)*	šifra	cena	opis (sa gredom)*	šifra	cena
Roletna za bazen 7,00 x 3,00 m	5060131	12.899,00 €	Roletna za bazen 7,00 x 3,00 m	5060150	13.153,00 €
Roletna za bazen 8,00 x 4,00 m	5060133	14.190,00 €	Roletna za bazen 8,00 x 4,00 m	5060151	14.622,00 €
Roletna za bazen 9,00 x 4,00 m	5060134	14.577,00 €	Roletna za bazen 9,00 x 4,00 m	5060152	14.970,00 €
Roletna za bazen 10,00 x 4,00 m	5060135	14.963,00 €	Roletna za bazen 10,00 x 4,00 m	5060153	15.318,00 €
Roletna za bazen 10,00 x 5,00 m	5060136	16.193,00 €	Roletna za bazen 10,00 x 5,00 m	5060155	16.823,00 €

Opis scala romana	šifra	cena
Rimske stepenice Ø do 3,00 m sa lamelama PVC mat bele	5060076	672,70 €
Rimske stepenice Ø do 3,00 m sa lamelama PVC mat pesak	5060077	672,70 €
Rimske stepenice Ø do 3,00 m sa lamelama PVC mat sivo	5060078	672,70 €

* Mere se odnose na **unutrašnje** mere bazena, bez dimenzije **kućišta** roletne
 * The measurements refer to the **internal dimensions** of the pool, excluding the dimension of the shutter compartment.

ZA OSTALE MODELE SKALA POGLEDATI TABELU NAKRAJU POGLAVLJA ROLETNA PREKRIVKI
FOR FURTHER STAIRS MODELS, SEE TABLE AT THE BOTTOM OF THE SHUTTER COVERS CHAPTER

OPCIJE / OPTIONS

TELESKOPSKI SREDNJI NOSAČ

REŠETKA max da 90 cm

Neophodna za čišćenje greda 100x100 većih od 5,10m širine, i greda 120x100, većih od 6,10m širine

TELESCOPIC INTERMEDIATE SUPPORT

duckboarding max 90 cm

essential for beams 100x100 more than 5.10m wide, and 120x100 more than 6.10 m wide

Teleskopski srednji nosač do 8m
Telescopic intermediate support up to 8m

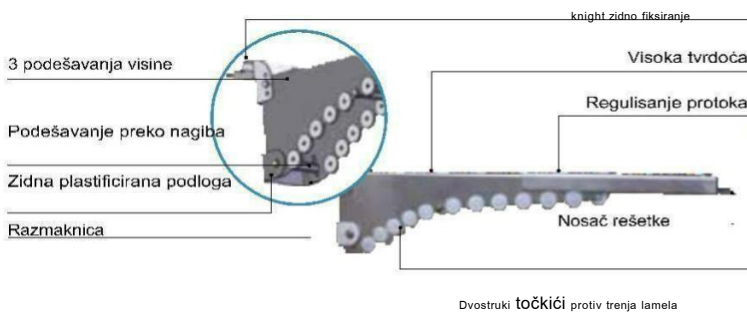

Povezni nosač za rešetke od 8 do 10m
Connection support for beams from 8 to 10 m



Šifra/code	Opcije Rollin	Cena/price
5 061013	Konektor 6 pin / 6-pin connector	448,40 €
5 061014	Ručica za odmrzavanje / wintering crank	394,60 €
5 061015	Štitnik liner / liner shield	273,80 €
5 061002	Odašiljač Wi-Key - omogućava instalaciju max 3 predajnika po svakom prijemniku Additional transmitter Wi-KEY - it allows to install max 3 transmitters for every receptor	422,50 €
5061003	Ploča daljinskog prijemnika Wi-Key — Neophodan je ako je predajnik instaliran na dosta udaljenom mestu od prijemnika ili ako neka zgrada ometa prolaz radio talasa Remote panel receptor Wi-Key - necessary if the transmitter is installed in a place very far from the receiver or if a building disturbs the passage of radio waves	169,50 €
5061004	Komplet za adaptaciju Wi-Key (prelazak sa kutije na ključ na Wi-key) / Adaptation kit Wi-Key (evolution from key box to Wi-Key)	1.076,60 €
5061005	Srednji teleskopski nosač za grede, kućište od 91 do 105 cm Telescopic intermediate support for beams, compartment from 91 to 105 cm	do 8 m up to 8 m 1.020,80 €
5061006	Srednji teleskopski nosač za grede, kućište od 91 a 105 cm Telescopic intermediate support for beams, compartment from 91 to 105 cm	do 10 m up to 10 m 2.917,10 €
5061001	Stop flow	138,70

ROLLIN

DA BI IZRAČUNALI FINALNU CENU
TO CALCULATE THE FINAL PRICE

1 + 2 + 3 + 4 + 5

Dimenzije bazena u m do	2,00x23,50	2,50x23,50	3,00x23,50	4,00x20,00	4,50x16,00	5,00x12,50	5,00x15,50	6,00x8,50	6,00x17,00	7,00x20,00	8,00x14,50	9,00x18,50	10,00x16,50
1 MEHANIČKA / mechanics	120Nm	120Nm	120Nm	120Nm	250Nm	120Nm	250Nm	120Nm	250Nm	250Nm	250Nm	500Nm	500Nm
Ø osovina / axis	Ø 140mm							Ø 170mm		Ø 180mm		Ø 250mm	
Vratilo, motor i pokretne ploče / pole, motor and rider plates	5060113	5060114	5060158	5060117	5060118	5060119	5060122	5060120	5060121	5060123	5060124	5060130	5060125
	8.318,60€	8.469,10€	8.518,20€	8.704,60€	8.789,80€	8.829,40€	10.364,30€	9.962,00€	11.520,70€	12.217,50€	12.306,20€	19.857,20€	20.343,40€
Kom za zidanje zidni ≤ 26cm Pieces to wall for wall ≤ 26 cm	5060170							538,90 €					
Kom zidni van standarda >26cm Pieces to wall non-standard >26cm	5060116							835,50 €					
2 LAMELE / slats: CENU MNOŽITI SA DUŽINOM BAZENA / PRICE TO MULTIPLE FOR THE LENGTH OF THE POOL													
Lamele PVC beli Mat Whiteopaque PVCslats	5060562	5060572	5060008	5060009	5060010	5060011	5060011	5060013	5060013	5060014	5060015	5060126	5060132
Lamele PVC pesak mat SandopaquePVCslats	5060563	5060573	5060016	5060017	5060018	5060019	5060019	5060021	5060021	5060022	5060023	5060127	5060137
Lamele PVC sivo mat GreyopaquePVCslats	5060564	5060574	5060024	5060025	5060026	5060027	5060027	5060029	5060029	5060030	5060031	5060128	5060142
Cena/price	249,30 €	257,70 €	264,20 €	347,80 €	387,20 €	437,60 €	437,60 €	509,50 €	509,50 €	564,00 €	633,10 €	698,50 €	786,50 €
Lamele PVC plavo mat / Light blue opaque PVC slats	5060565	5060575	5060032	5060582	5060034	5060035	5060035	5060037	5060037	5060038	5060039	5060129	5060149
Cena/price	258,00 €	269,60 €	276,60 €	415,40 €	442,30 €	480,90 €	480,90 €	532,30 €	532,30 €	602,70 €	674,10 €	801,80 €	969,70 €
Lamele L84 PVC Belo ili sivo mat / L84 PVC slats white or gray matte	5060585	5060586	5060587	5060589	5060590	5060591	5060591	-	-	-	-	-	-
Cena/price	205,30 €	225,20 €	237,90 €	313,00 €	348,50 €	393,90 €	393,90 €	-	-	-	-	-	-
Lamele polikarbonat solarni / Polycarbonate solar slats	5060566	5060576	5060046	5060047	5060584	5060049	5060049	5060051	5060051	5060143	5060144	5060148	5060146
Cena/price	698,60 €	790,50 €	878,20 €	1.074,10 €	1.283,20 €	1.350,80 €	1.350,80 €	1.632,20 €	1.632,20 €	1.898,80 €	2.175,40 €	2.443,90 €	2.822,30 €
3 SETA ZA KAČENJE PUSHLOCK / Pushlock coupling kit CENU MNOŽITI SA BROJEM DATIM KOMADIMA / Price to be multiplied by the number of pieces assigned													
Zidni/to wall Cena kom/ single price	5061010							91,00 €					
Količina / quantity	2	2	2	3	3	3	3	4	4	4	5	5	5
Pokretni nosač / rider nosač visoki/highrider Komadna cena/ single price	5061011 5061012							162,80 €					
Količina / quantity	2	2	2	3	3	3	3	4	4	4	5	5	5
4 KUTIJE OSOLONCI GREDE / beam support													
zidni to wall	5060058							318,00 €					
Pokr.nosač ravnih regulacioni flat adjustable rider	5060059							520,80 €					
5 GREDA / beams KAKO IZABRATI GREDU Vd. pag 368 / HOW TO CHOOSE THE BEAM see pag 368 * (cene se odnose na belu boju / prices refer to the colour white)													
zidni / to wall 100x100 mm	5060570	5060571	5060577	5060060	5060578	5060061	5060061	5060062**	5060062**	5060063**	5060579**	Consultateci/consult us	
	1.028,10€	1.173,10€	1.289,40€	1.316,40€	1.471,60€	1.514,40€	1.514,40€	2.594,60€	2.594,60€	3.297,90€	4.327,50€		
zidni / to wall 120x100 mm	5060580	5060581	5060598	5060064	5060465	5060065	5060065	5060066	5060066	Consultateci/consult us			
	1.107,30€	1.180,10€	1.338,50€	1.441,50€	1.813,70€	1.834,30€	1.834,30€	2.160,60€	2.160,60€				
Pokr.nosač / rider 100x100 mm	5060599	5060600	5060601	5060068	5060602	5060069	5060069	5060070**	5060070**	5060071**	5060603**	Consultateci/consult us	
	790,50€	939,40€	1.047,10€	1.067,70€	1.356,00€	1.427,20€	1.427,20€	2.512,30€	2.512,30€	3.218,70€	4.147,00€		
Pokr.nosač / rider 120x100 mm	5060604	5060605	5060606	5060072	5060607	5060073	5060073	5060074	5060074	Obratite nam se/consult us			
	869,70€	942,50€	1.100,90€	1.203,90€	1.576,10€	1.596,70€	1.596,70€	1.923,00€	1.923,00€				

* Za naknadne grede veće od 6,00 m (pesak i sivo) nama se obratite. Cene po meri. For further beams larger than 6.00 m (sand and grey) please consult us. Customised prices.

**Za šifre: 5060062, 5060063, 5060579, 5060070, 506007, 5060603 u cenu je uračunat posrednički teleskopski nosač / Price included the telescopic intermediate support

ROLLENERGY EVOLUTION E ROLLIN

KAKO ODABRATI GREDU? / HOW TO CHOOSE THE BEAM?

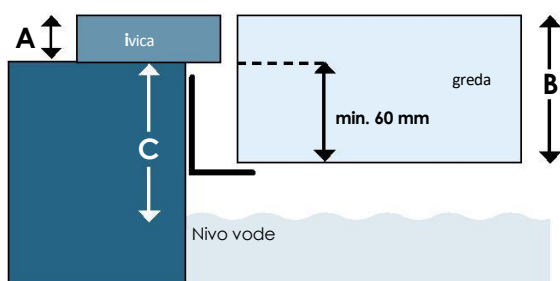

LIVELLO ACQUA (C) WATER LEVEL (C)	MAKSIMALNA VISINA IVICE (A) MAXIMUM HEIGHT OF THE TILE				
	60	50	40	30	20
100	120	-	100	-	-
110	-	120	-	100	-
120	-	-	120	-	100
130	-	-	-	120	-

Dimenzije grede u mm (B) / beams dimensions in mm (B)

GREDE 100 x 100 mm O 120 x 100 mm U LAKIRANOM ALUMINIJUMU / BEAMS 100 x 100 mm OR 120 x 100 mm IN LACQUERED ALUMINIUM

ZA OSTALE GREDE VEĆE OD 6,00 M (PESAK I SIVO) KONSULTUJTE NAS. NAMENSKI PRILAGODENE CENE.
FOR FURTHER BEAMS LARGER THAN 6.00 M (SAND AND GREY) PLEASE CONSULT US. CUSTOMISED PRICES.

ZA NOVE BAZENE / NEW POOLS

Za zidne kutije
For supports to wall

belo, pesak i sivo
white, sand and grey

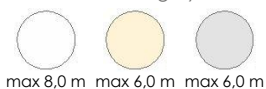

max 8,0 m max 6,0 m max 6,0 m

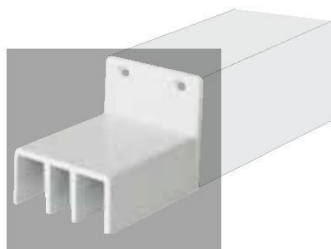

Greda za zidne kutije
Support to wall putrella

ZA POSTOJEĆE BAZENE / EXISTING POOLS

Za rider kutije
For rider supports

belo, pesak i sivo
white, sand and grey

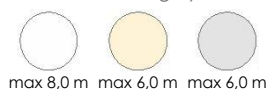

max 8,0 m max 6,0 m max 6,0 m

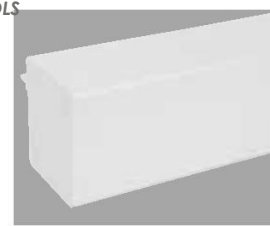

Greda nosač
Rider putrella

KUTIJE NOSAČI GREDA / BEAMS SUPPORT

ZA NOVE BAZENE / NEW POOLS

Zidne kutije
Supports to wall



ZA POSTOJEĆE BAZENE / EXISTING POOLS

Rider kutije podesiva ploča
Flat adjustable rider supports



NA RASPOLAGANJU / AVAILABLE

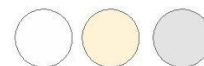

belo, pesak i sivo
white, sand and grey

Šifra/code	Opis/description		Cena/price
5060058	Zidne kutije / supports to wall	par / the couple	318,00 €
5060059	Rider kutije podesiva ploča Flat adjustable rider supports	par / the couple	520,80 €

SET ZA KAČENJE PUSHLOCK / FASTENING SYSTEM PUSHLOCK

Sistemi za kačenje za skimmer bazene / Coupling systems for skimmer pools

NA RASPOLAGANJU / AVAILABLE IN

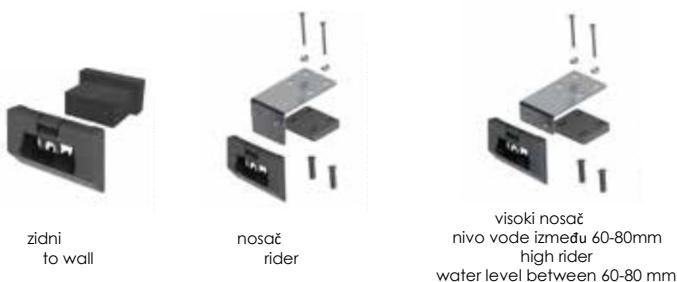

zidni
to wall

nosač
rider

visoki nosač
nivo vode između 60-80mm
high rider
water level between 60-80 mm



belo
white

pesak
sand

sv.plavo
light blue

zeleno
green

svetlo sivo
light grey

tamno sivo
dark grey

Šifra/code	Opis/description	Cena/price
5061010	Pushlock zidni / Pushlock to wall	91,00 €
5061011	Pushlock nosač / Rider pushlock	162,80 €
5061012	Pushlock visoki nosač / High rider pushlock	162,80 €

PRIBOR ZA ČIŠĆENJE PREKRIVKI / CLEANING ACCESSORIES FOR COVERS

Šifra/code	Opis/description	Cena/price
9030041	COVERNET – Proizvod za čišćenje zimskih i automatskih prekrivki, razgrađuje i eliminiše prljavštinu 5 l/ COVERNET - Cleaning product of winter and automatic cover, dissolves and removes dirt 5	71,80 €

**POKLOPAC ZA PREKRIVANJE OTVORA ZA POTOPLJENE PREKRIVKE
FOOTBOARD COMPARTMENT COVER FOR IMMERSSED COVERINGS**



EGZOTIČNO DRVO /
exotic wood

Šifra/ code	Opis/description	Cena/ price
5050173	Poklopac za prekrivanje otvora do 1 m širine od egzotičnog drveta/m2	420,00 €
5050174	Poklopac za prekrivanje otvora preko 1 m širine od egzotičnog drveta po m2	455,00 €

Poklopci moraju biti tretirane zaštitnim sredstvom
The platform must be treated with protective substance for wood

SECURYWALL ZA RAVNO DNO / SECURYWALL FOR FLAT BOTTOM



KARAKTERISTIKE

- OBLIGE**
 - Paneli PVC, debljina 40 mm
 - Smanjena težina
 - Otpornost na UV zrake i na hemijske proizvode
 - Izvanredna otpornost na koroziju
 - Visoka mehanička tvrdoća
 - Na raspolaganju u tri boje: bela, pesak ili siva
- PLOČE ZA FIKSIRANJE**
 - U belom kompozitu ispunjenom fibreglasom, nevidljive pošto supostavljene iza pregradnog zida
 - Pozicioniranje potpornih kutija grede predviđeno na pločama
- RAM**
 - Izrađen sa ergonomskim profilom u kompozitnom materijalu ojačanim staklenim vlaknom.

Čvrst i otporan pregradni zid sa besprekornom završnom obradom. Preporučuje se kao dodatak prekrivkama Rollenergy Evolution e Rollin. Jednostavna instalacija, isporučen montiran. Prilagodljiv svim vrstama bazena i tipologijama dna, do 7,07 m širine e 2,07 m dubine.

Solid and resistant separation wall of impeccable finish. Complement recommended to covers Rollenergy Evolution and Rollin. Simple installation, delivered assembled. It adapts to all types of swimming pools and types of bottom, up to 7.07 m in width and 2.07 m in depth.

NA RASPOLAGANJU / AVAILABLE IN



FEATURES

- COVERING**
 - PVC panels, thickness 40 mm
 - Low weight
 - UV resistance and chemicals
 - Excellent corrosion resistance
 - High mechanical strength
 - 3 colours available: white, sand or grey
- FIXING PLATES**
 - Composite white loaded with glass fiber, located behind the separation wall therefore invisible
 - Supports beam positioning on the plates
- FRAME**
 - Frame made of an ergonomic profile made of glass fiber reinforced composite material



Boja securywall Securywall colour	Širina bazena(m) Pool width (m)	Dubina bazena (m) / Pool depth (m)							
		Šifra	≤ 1,07	Šifra	≤ 1,32	Šifra	≤ 1,57	Šifra	≤ 1,82
Bela boja White colour	≤ 4,07	5061016	1.915,70 €	5061023	2.110,60 €	5061030	2.288,00 €	5061050	2.412,50 €
	≤ 5,07	5061017	2.698,20 €	5061024	2.901,00 €	5061031	3.127,50 €	5061051	3.282,10 €
	≤ 6,07	5061018	3.022,90 €	5061025	3.249,40 €	5061032	3.504,50 €	5061052	3.690,80 €
	≤ 7,07	5061019	3.344,50 €	5061026	3.602,70 €	5061033	3.886,20 €	5061053	4.102,60 €
Boja Pesak ili siva Sand or grey colour	≤ 4,07	5061020	2.590,50 €	5061027	2.748,90 €	5061034	3.095,80 €	5061054	3.187,10 €
	≤ 5,07	5061021	3.878,30 €	5061028	4.060,50 €	5061035	4.453,30 €	5061055	4.592,10 €
	≤ 6,07	5061022	4.364,60 €	5061029	4.580,00 €	5061036	5.017,20 €	5061056	5.182,90 €

ROLLINSIDE



Prekrivka ROLLINSIDE, roletna sa unutrašnjim kućištem, podesna bazenima do 10 m širine (1 strana) i 6 m širine (2 strane). Prednosti su višestruke: funkcionalni koncept prilagodljiv mnogim konfiguracijama, diskretna estetika pošto oslobađa kompletnu površinu vode. Motori 120 Nm i 250 Nm prema dimenzijama bazena. Čvrsto kablo za napajanje, kolektori graničnika otporni i neosetljivi na gromove sa pojednostavljenim ožičenjem.

The ROLLINSIDE cover, shutter with inner housing, fits pools up to 10 m in width (1 face) and 6 m in width (2 faces). The advantages are many: a very functional concept, it adapts to many configurations, discreet aesthetics because it frees the totality of the body of water. Motors 120 Nm and 250 Nm depending on the size of the pool. Sturdy power cable, resistant and insensitive to lightning collectors of limit switch with simplified wiring.

KARAKTERISTIKE

1. **MOTORIZACIJA**
 - 2 izbora motorizacije i mogućeg fiksiranja:
 - Motoru suvom kućištu - zidno fiksiranje
 - Cevni motor – zidno fiksiranje
 - Snaga se određuje u funkciji dimenzije bazena i dubine na kojem će biti instalirana Rollinside:
 - 120, 250, 500 o 750 Nm (750 Nm: cevni motor)
 - Automatski prekidač: štampano kolo koje omogućava zaustavljanje otvaranja u slučaju detekcije neuobičajenih dejstava na prekrivci (za motore 120 e 250 Nm)
 - Upravljanje ključem ili Wi-Key
2. **ELOKSIRANO ALUMINIJUM VRATILO 20 MICRONS**
3. **ELOKSIRANA ALUMINIJUM GREDA**
 - Dimenzije 150x100 mm
 - Verzija 1 strana: 2 grede na visokom delu
 - Verzija 2 strane: 3 grede od kojih 2 u gornjem delu i 1 u donjem delu da bi održale u vertikalni rešetku
4. **KUĆIŠTE**
 - Rešetka u PVC da 1 x 0,75 m fiksirana na grede pomoću stezaljki. 3 boje na raspolaganju: bela, pesak, siva.
 - Rešetka PVC za oblaganje armiranom membranom (debljina rešetke: 20 mm)
 - Rešetka IPÉ od 1,00x0,75 m (glatki finiš)
 - Za ostala kućišta nam se obratite.
5. **PROREZ**
 - Bazen sa radijusom < 5 cm: prorez od 7 cm
 - Bazen sa radijusom od 5 do 15 cm: prorez od 5 cm (sa ugaonom opcijom)
6. **LAMELE**
 - Lamele PVC ili solatni polikarbonat
7. **SET ZA KAČENJE**
 - Pushlock

FEATURES

1. **MOTORIZATION**
 - 2 choices of possible motorizations and fixings:
 - Motor in dry compartment - fixing to wall
 - Tubular motor - fixing to wall
 - The power is determined according to the size of the pool and the depth at which it will be installed the Rollinside: 120,250,500 or 750 Nm (750Nm: tubular motor)
 - Automatic switch: printed circuit that allows to stop the cover after detection of anomalous stress on the cover (for motors 120 and 250 Nm)
 - Control by box key or Wi-Key
2. **ANODIZED ALUMINIUM POLE 20 MICRONS**
3. **ANODIZED ALUMINIUM BEAM**
 - Dimensions 150x100 mm
 - 1 face version: 2 beams in the high part
 - 2 faces version: 3 beams of which 2 in the upper part and 1 in the bottom part to keep the duckboarding vertical
4. **HOUSING**
 - PVC duckboarding 1 x 0,75 m fixed on the beams thanks to fixing clips. 3 available colors ; white, sand and grey.
 - PVC duckboarding to coat with reinforced membrane (duckboarding thickness: 20 mm)
 - IPÉ duckboarding 1,00x0,75 m (smooth finish)
 - For other housings please contact us
5. **SLIT**
 - Pool with ray < 5 cm: slit of 7 cm
 - Pool with ray from 5 to 15 cm: slit of 5 cm (with corners option)
6. **SLATS**
 - PVC opaque slats or polycarbonate solar
7. **HOOKING KIT**
 - Pushlock

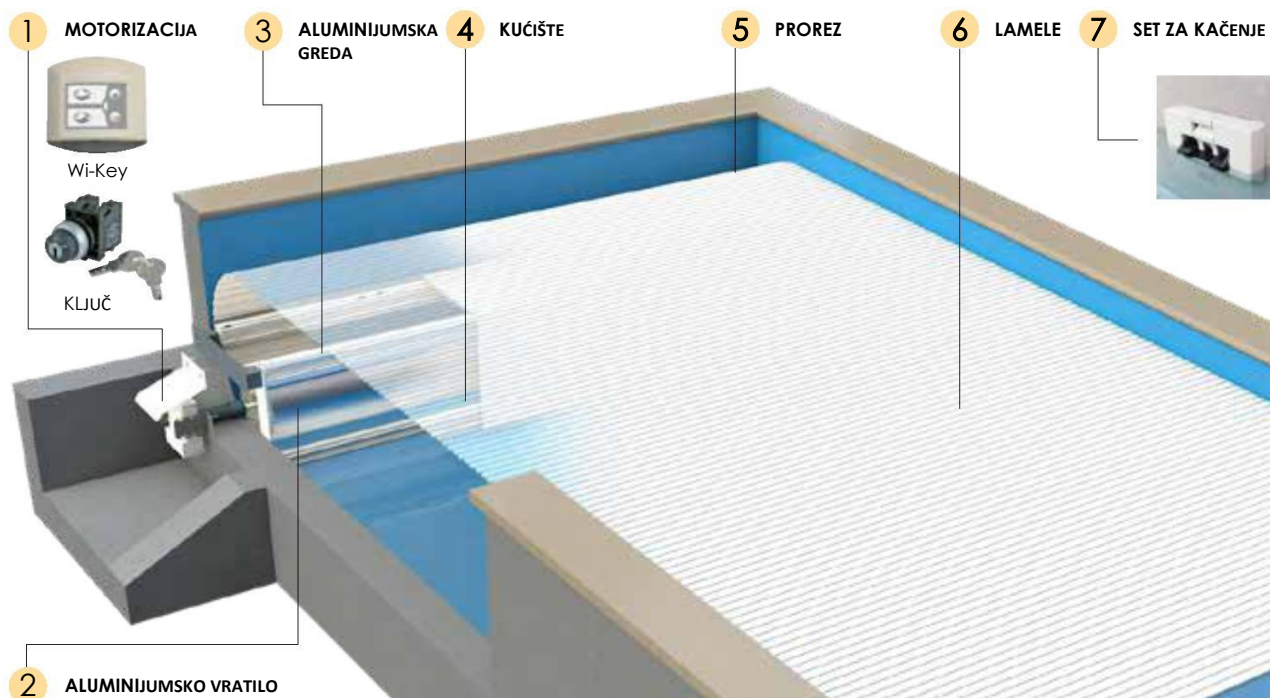

Rollinside verzija 2 strane, motor suvo kućište
Rollinside 2 faces version, motor dry compartment

KONFIGURACIJE/ CONFIGURATIONS

koncept Rollinside deli se u 2 verzije: / The Rollinside concept comes in 2 versions:

1- KUĆIŠTE JEDNA STRANA HORIZONTALNA
1 - One face horizontal housing

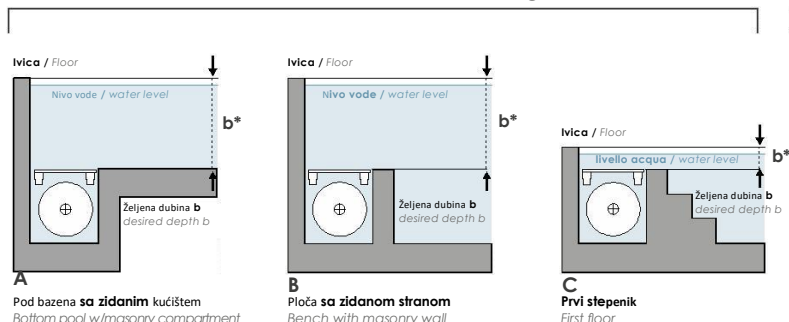

*Minimalna visina quota b : 10 cm / Minimum height b : 10 cm

2 - KUĆIŠTE DVE STRANE HORIZONTALNE I VERTIKALNA
2 - two faces horizontal and vertical housing

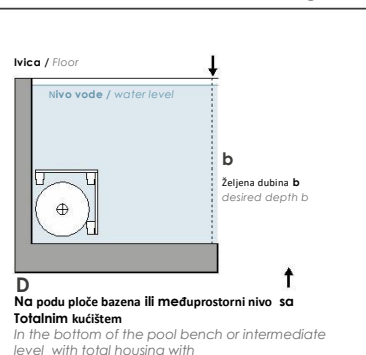

OPCIJE / OPTIONS

UGAONI ZA BAZENE SA RADIJUSOM

Ugaoni se koristi kada bazen raspolaže radijusom od 5 do 15 cm u uglovima. Omogućava napredovanje pozicioniranja kanala i omogućava prolaz lamela. Od PVC od 1,5 cm debljine. Može se obložiti con armiranom membranom.



CORNER FOR POOLS WITH RAYS

The corner is used when the pool has rays from 5 to 15 cm in the angle. It allows to advance the positioning of the slit and it allows the passage of the slats. In PVC of 1,5 cm of thickness. Can be covered with reinforced membrane.

SET ZA ADAPTACIJU LINER

Ova opcija je obavezna za bazeme opremljene lajnerom Sa radijusima ≤ 5 cm u nivou kanala. Omogućava da se liner stisne na uglovima radi izbegavanja trenja sa lamelama.

LINER ADAPTATION KIT

This option is required for pools equipped with a liner with rays ≤ 5 cm in the slit. It allows you to push the liner against the corners and avoid friction with the slats.

ŠIFRA/code	OpCije Rollinside/option Rollinside	Cena/price
5061000	Konekciona kutija connection box	64,20 €
5061002	Prenosnik Wi-Key dodatni - omogućava instaliranje max 3 prenosnika po prijemniku Additional transmitter Wi-KEY - it allowsto install max 3 transmitters for every receptor	422,50 €
5061003	Daljinska table prijemnik Wi-Key Remote panel receptor Wi-Key	169,50 €
5061004	Adaptacioni SET Wi-Key (passaggio da scatola a chiave al Wi-key) Adaptation kit Wi-Key (evolution from key box to Wi-Key)	1.076,60 €
5061015	Štitnik linera (jedino model suvog kućišta) /liner shield (only model dry compartment)	273,80 €
5061014	Ručka za prezimljavanje (jedino model suvog kućišta)/wintering crank (only model dry compartment)	394,60 €
5061013	Konektor 6 pin (jedino model suvog kućišta) /6 pin connector (only model dry compartment)	448,40 €
5060260	Ugaoni od > 5 a ≤ 15 cm Corner from > 5 to ≤15 cm	936,80 €
5060261	Set za adaptaciju liner Liner adaptation kit	296,70 €

ROLLINSIDE 1 LATO / 1 SIDE
KUČIŠTE JEDNA STRANA HORIZONTALNO / ONE FACE HORIZONTAL HOUSING

PRE RAČUNANJA CENE IZABERI KOREKTNU MOTORIZACIJU!
BEFORE CALCULATING THE FINALE PRICE CHOOSE THE CORRECT MOTORIZATION!

1

Mehanika: komadi za zidanje ili zidni komplet, vratilo I motor

Da bi se definisala snaga motora i prečnik vratila potrebno je:

- a Odrediti širinu i dužinu bazena
 - b Odrediti dubinu između ivice i gornjeg dela rešetke
- dobijete potrebnu snagu motora i prečnika vratila

Mechanism: pieces to wall or masonry kit, pole and motor

To define the motor power and the diameter of the pole necessary:

- a Identify the width and length of the pool
 - b Identify the depth between the level surface and the upper side of the duckboarding
- You have the motor power and the diameter of the pole necessary

PRIMER RAČUNANJA / EXAMPLE

Bazen od 4,5 x 10,5 m:
a - uzeti u obzir širinu od 5 m i dužinu od 11 m
b - dubina između ivice i gornjeg dela rešetke može biti < 0,55 m, između 0,55 m i 1,34 m ili između 1,34 i 2,18 m
→ Bazen je 1,70 m dubine: motor od 750 Nm, vratilo od 140 mm
Pools 4,50 x 10,5 m
a - consider the width 5 m and length 11 m
b - the depth between the level surface and the upper side of the duckboarding can be < 0,55 m, between 0,55 m and 1,34 m or between 1,34 and 2,18 m
→

		ŠIRINA BAZENA / width pool a																				
		3 m			4 m			5 m														
DUŽINA BAZENA SA STEPENICAMA a length pool/included stair	4 m	1,00	1,96	2,10	0,67	1,38	2,10	4,50	0,47	1,04	2,28	3,58	-	-	-							
	5 m	0,89	1,76	2,10	0,58	1,23	2,10	4,10	0,40	0,92	2,05	3,23	-	-	-							
	6 m	0,79	1,60	2,10	0,51	1,11	2,10	3,70	0,34	0,83	1,87	2,97	-	-	-							
	7 m	0,72	1,47	2,10	0,45	1,02	2,10	3,50	0,30	0,75	1,72	2,75	-	-	-							
	8 m	0,66	1,37	2,10	0,41	0,94	2,09	3,30	0,26	0,68	1,61	2,57	-	-	-							
	9 m	0,61	1,28	2,10	0,37	0,87	1,97	3,10	0,23	0,63	1,51	2,42	-	-	-							
	10 m	0,56	1,20	2,10	0,34	0,82	1,86	2,95	0,20	0,59	1,42	2,29	-	-	-							
	11 m	0,52	1,14	2,10	0,31	0,77	1,76	2,81	-	0,55	1,34	2,18	-	-	-							
	12 m	0,49	1,08	2,10	0,28	0,72	1,68	2,69	-	0,51	1,28	2,08	-	-	-							
	13 m	0,46	1,03	2,10	0,26	0,69	1,61	2,57	-	0,48	1,22	2,00	-	-	-							
	14 m	0,43	0,98	2,10	0,24	0,65	1,54	2,48	-	0,45	1,16	1,91	-	-	-							
	15 m	0,41	0,94	2,09	0,22	0,62	1,48	2,39	-	0,43	1,12	1,84	-	-	-							
	16 m	0,39	0,90	2,02	0,20	0,59	1,43	2,30	-	0,40	1,07	1,78	-	-	-							
	17 m	0,36	0,86	1,95	-	0,56	1,38	2,23	-	-	-	-	0,38	1,03	1,69							
	18 m	0,35	0,83	1,89	-	0,54	1,33	2,16	-	-	-	-	0,36	1,00	1,64							
	19 m	0,33	0,80	1,83	-	0,52	1,29	2,10	-	-	-	-	0,35	0,96	1,59							
	20 m	0,31	0,78	1,78	-	0,50	1,25	2,00	-	-	-	-	0,33	0,93	1,54							
	Motor Motor		120 Nm	250 Nm	500 Nm	120 Nm	250 Nm	500 Nm	750 Nm	120 Nm	250 Nm	500 Nm	750 Nm	250 Nm	500 Nm	750 Nm						
	Albero Pole		140 mm	140 mm	140 mm	140 mm	140 mm	140 mm	140 mm	140 mm	140 mm	140 mm	170 mm	170 mm	170 mm							
	Ø Asse Ø Axis		30 mm																			
		LARGHEZZA VASCA / width pool a																				
		6 m			7 m			8 m			9 m			10 m								
LUNGHEZZA VASCA COMPRESA SCALA a	4 m	0,81	1,84	2,79	-	-	-	0,68	1,51	2,40	0,56	1,30	2,00	-	0,37	0,95	1,56	0,31	0,83	1,37		
	5 m	0,71	1,65	2,53	-	-	-	0,59	1,36	2,16	0,48	1,15	1,86	-	0,31	0,86	1,42	0,25	0,74	1,25		
	6 m	0,63	1,50	2,33	-	-	-	0,52	1,23	1,98	0,42	1,00	1,70	-	0,27	0,78	1,31	0,21	0,67	1,15		
	7 m	0,57	1,38	2,17	-	-	-	0,41	1,08	1,80	0,36	0,95	1,57	-	0,23	0,71	1,22	-	0,61	1,07		
	8 m	0,51	1,28	2,03	-	-	-	0,37	1,00	1,67	0,28	0,84	1,42	-	-	0,65	1,14	-	0,55	1,00		
	9 m	0,47	1,20	1,91	-	-	-	0,33	0,94	1,57	0,25	0,78	1,34	-	-	0,59	1,06	-	0,51	0,92		
	10 m	0,43	1,13	1,81	-	-	-	0,30	0,88	1,49	0,22	0,73	1,26	-	-	0,55	1,00	-	0,46	0,86		
	11 m	0,40	1,06	1,72	-	-	-	0,28	0,83	1,42	0,20	0,69	1,20	-	-	0,51	0,94	-	0,42	0,81		
	12 m	0,37	1,01	1,64	-	-	-	0,20	0,72	1,28	-	0,58	1,07	-	-	0,47	0,89	-	0,39	0,76		
	13 m	0,34	0,96	1,57	-	-	-	0,16	0,67	1,21	-	0,54	1,01	-	-	0,44	0,84	-	0,35	0,72		
	14 m	0,32	0,91	1,51	-	-	-	-	0,63	1,15	-	0,50	0,95	-	-	0,40	0,79	-	0,32	0,67		
	15 m	0,30	0,87	1,45	-	-	-	-	0,59	1,09	-	0,46	0,90	-	-	0,37	0,75	-	0,30	0,64		
	16 m	0,28	0,84	1,40	-	-	-	-	0,55	1,04	-	0,43	0,86	-	-	0,34	0,71	-	0,27	0,60		
	17 m	0,26	0,80	1,35	-	-	-	-	0,51	1,00	-	0,39	0,81	-	-	0,32	0,67	-	0,24	0,57		
	18 m	-	-	-	0,25	0,77	1,24	-	0,48	0,95	-	-	-	0,77	-	0,29	0,64	-	-	-	-	
	19 m	-	-	-	0,23	0,75	1,19	-	0,45	0,90	-	-	-	0,74	-	0,27	0,61	-	-	-	-	
	20 m	-	-	-	0,22	0,72	1,12	-	0,42	0,86	-	-	-	0,70	-	0,24	0,58	-	-	-	-	
	Motor Motor		250Nm	500Nm	750Nm	250Nm	500Nm	750Nm	120Nm	250Nm	500Nm	750Nm	250Nm	500Nm	750Nm	250Nm	500Nm	750Nm				
	Albero Pole		170mm	170mm	170mm	180mm	180mm	180mm	180mm	180mm	180mm	180mm	180mm	180mm	250mm	250mm	250mm	250mm	250mm			
	Ø Asse Ø Axis		30 mm														45 mm					

DUBINA IZMEĐU IVICE I GORNJEG DELA REŠETKE b
depth between the level surface and the upper side of the duckboarding

PROFONDITÀ TRA IL BORDO E IL LATO SUPERIORE DEL CARABOTTINO b
depth between the level surface and the upper side of the duckboarding

ROLLINSIDE
1 STRANA

 ZA OBRAČUN KRAJNE CENE
TO CALCULATE THE FINAL PRICE

1 + 2 + 3 + 4 + 5

Dimensioni piscina in m fino a/Pool size in m up to	3,00x20,00	4,00x20,00	5,00x20,00	6,00x20,00	7,00x20,00	8,00x20,00	9,00x20,00	10,00x17,00	
1 MEHANIKA: KOMADI ILI SET ZA ZIDANJE, VRATILO / MOTOR / mechanics pieces to wall or masonry kit, pole and motor									
Kom za zid - fiksiranje za zid Pieces to wall - fixing to wall				5060170					
				538,90 €					
Zidni komadi van standardni>26cm Pieces to wall non-standard >26cm				5060116					
				835,50 €					
Zidni komadi – cevasto fiksiranje Pieces to wall - fixing to wall				5060054					
				538,90 €					
Motor 120 Nm Motor 120 Nm	140 mm	5060199	5060200	5060201					
		9.801,20 €	9.938,50 €	10.408,70 €					
Motor 250 Nm Motor 250 Nm	140 mm	5060159	5060202	5060203					
		11.497,70 €	11.635,00 €	11.918,20 €					
	170 mm			5060204	5060205				
				12.811,60 €	13.041,30 €				
	180 mm				5060206	5060207	5060208		
				14.878,70 €	15.268,30 €	15.729,30 €			
	250 mm						5060209	5060210	
							21.683,50 €	22.139,70 €	
Motor 500 Nm Motor 500 Nm	140 mm	5060198	5060211	5060212					
		15.280,30 €	15.414,40 €	15.700,80 €					
	170 mm			5060213	5060214				
				16.225,10 €	16.475,40 €				
	180 mm				5060215	5060216	5060217		
				18.426,90 €	19.324,90 €	19.782,70 €			
	250 mm						5060218	5060219	
							25.464,50 €	26.267,60 €	
Motor 750 Nm Motor 750 Nm	140 mm		5060220	5060221					
			19.193,80 €	19.478,70 €					
	170 mm			5060222	5060223				
				20.075,80 €	20.330,90 €				
	180 mm				5060224	5060225	5060226		
				22.277,60 €	23.172,50 €	23.975,60 €			
	250 mm						5060227	5060228	
							30.162,70 €	30.503,20 €	
								30.964,20 €	
2 LAMELE / slats: CENU MNOŽITI SA DUŽINOM BAZENA / PRICE TO MULTIPLE FOR THE LENGTH OF THE POOL									
Lamele PVC belo mat White opaque PVC slats		5060008	5060009	5060011	5060013	5060014	5060015	5060126	5060132
Lamele PVC pesak mat Sand opaque PVC slats		5060016	5060017	5060019	5060021	5060022	5060023	5060127	5060137
Lamele PVC sivo mat Grey opaque PVC slats		5060024	5060025	5060027	5060029	5060030	5060031	5060128	5060142
		264,20 €	347,80 €	437,60 €	509,50 €	564,00 €	633,10 €	698,50 €	786,50 €
Lamele PVC svetlo plavo mat Light blue opaque PVC slats		5060032	5060033	5060035	5060037	5060038	5060039	5060129	5060149
		276,60 €	415,40 €	480,90 €	532,30 €	602,70 €	674,10 €	801,80 €	969,70 €
Lamele L84 PVC belo ili mat sivo L84 PVC slats white or gray matte		5060587	5060589	5060591	-	-	-	-	-
		237,90 €	313,00 €	393,90 €	-	-	-	-	-
Lamele policarbonat solarni / Polycarbonate solar slats		5060046	5060047	5060049	5060051	5060143	5060144	5060148	5060146
		878,20 €	1.074,10 €	1.350,80 €	1.632,20 €	1.898,80 €	2.175,40 €	2.443,90 €	2.822,30 €
3 SETA za kačenje PUSHLOCK / Pushlock coupling kit - PREZZO DA MOLTIPLICARE PER IL NUMERO DI PEZZI ASSEGNATI / Price to be multiplied by the number of pieces assigned									
ZA ZID/to wall					5061010				
Kom.cena/ single price					91,00 €				
Količina / quantity		4	6	6	8	8	10	10	10
Nosač / rider ili visoki nosač / high rider					5061011	5061012			
Kom.cena/single price					162,80 €				
Količina / quantity		4	6	6	8	8	10	10	10
4 GREDE / beams									
Zidni komadi za grede-uzidno fiksiranje Beams support - fixing to wall					5060237				
					323,80 €				
Grede Beams		5060238	5060239	5060240	5060241	5060274	5060242	5060275	5060243
		2.339,60 €	2.783,10 €	3.214,0 €	3.646,40 €	5.163,90 €	5.468,00 €	5.821,20 €	6.163,40 €
5 GAZIŠTA / duckboarding									
Gazište PVC PVC duckboarding		5060244	5060245	5060246	5060247	5060248	5060249	5060250	5060251
		1.506,40 €	2.008,60 €	2.510,70 €	3.012,80 €	3.514,90 €	4.017,10 €	4.519,20 €	5.021,30 €
Gazište za oblaganje Duckboarding to coat		5060252	5060253	5060254	5060255	5060256	5060257	5060258	5060259
		2.480,60 €	3.307,40 €	4.134,30 €	4.961,10 €	5.788,00 €	6.614,80 €	7.441,70 €	8.268,50 €

ROLLINSIDE 2 STRANE /2 SIDES
 DVOSTRANO KUĆIŠTE HORIZONTALNO I VERTIKALNO / TWO FACES HORIZONTAL AND VERTICAL HOUSING

PRE OBRAČUNA CENE IZABERI KOREKTNU MOTORIZACIJU!
 BEFORE CALCULATING THE PRICE CHOOSE THE CORRECT MOTORIZATION!

- 1** **Mehanika: komadi za zid ili zidni set, vratilo i motor**
 Da bi definisali snagu motora i prečnik vratila potrebno je:
 a odrediti širinu i dužinu bazena
 b odrediti dubinu između ivice i gornjeg dela rešetke
 → Imate potrebnu snagu motora i prečnik vratila
Mechanism: pieces to wall or masonry kit, pole and motor
 To define the motor power and the diameter of the pole necessary:
 a Identify the width and length of the pool
 b Identify the depth between the level surface and the upper side of the duckboarding
 → You have the motor power and the diameter of the pole necessary

PRIMER RAČUNANJA / EXAMPLE
 Bazen od 4,5 x 10,5 m:
 a - uzeti u obzir širinu od 5 m i dužinu od 11 m
 b - ukupna dubina bazena može biti < 1,42 m, tra 1,42 m e 2,21 m ili između 2,21 e 3,05 m
 → Bazen je 1,70 m dubine: motor od 500 Nm, vratilo od 140 mm
 Pools 4,50 x 10,5 m
 a - consider the width 5 m and length 11 m
 b - the total depth of the pool can be < 1,42 m, between 1.42 m and 2.21 m or between 2.21 and 3.05 m
 The pool is 1,70 m depth: motor of 500 Nm, pole of 140 mm

		ŠIRINA BAZENA / width pool a																	
		3 m			4 m			5 m						6 m					
LUNGHEZZA VASCA COMPRESA SCALA a length pool/depth of stair	4 m	1,87	2,83	2,97	1,54	2,25	2,97	5,37	1,34	1,91	3,15	4,45	-	-	-	1,68	2,71	3,66	
	5 m	1,76	2,63	2,97	1,45	2,10	2,97	4,97	1,27	1,79	2,92	4,10	-	-	-	1,58	2,52	3,40	
	6 m	1,66	2,47	2,97	1,38	1,98	2,97	4,57	1,21	1,70	2,74	3,84	-	-	-	1,50	2,37	3,20	
	7 m	1,59	2,34	2,97	1,32	1,89	2,97	4,37	1,17	1,62	2,59	3,62	-	-	-	1,44	2,25	3,04	
	8 m	1,53	2,24	2,97	1,28	1,81	2,96	4,17	1,13	1,55	2,48	3,44	-	-	-	1,38	2,15	2,90	
	9 m	1,48	2,15	2,97	1,24	1,74	2,84	3,97	1,10	1,50	2,38	3,29	-	-	-	1,34	2,07	2,78	
	10 m	1,43	2,07	2,97	1,21	1,69	2,73	3,82	1,07	1,46	2,29	3,16	-	-	-	1,30	2,00	2,68	
	11 m	1,39	2,01	2,97	1,18	1,64	2,63	3,68	-	1,42	2,21	3,05	-	-	-	1,27	1,93	2,59	
	12 m	1,36	1,95	2,97	1,15	1,59	2,55	3,56	-	1,38	2,15	2,95	-	-	-	1,24	1,88	2,51	
	13 m	1,33	1,90	2,97	1,13	1,56	2,48	3,44	-	1,35	2,09	2,87	-	-	-	1,21	1,83	2,44	
	14 m	1,30	1,85	2,97	1,11	1,52	2,41	3,35	-	1,32	2,03	2,78	-	-	-	1,19	1,78	2,38	
	15 m	1,28	1,81	2,96	1,09	1,49	2,35	3,26	-	1,30	1,99	2,71	-	-	-	1,17	1,74	2,32	
	16 m	1,26	1,77	2,89	1,07	1,46	2,30	3,17	-	1,27	1,94	2,65	-	-	-	1,15	1,71	2,27	
	17 m	1,23	1,73	2,82	-	1,43	2,25	3,10	-	-	-	-	1,25	1,90	2,56	1,13	1,67	2,22	
	18 m	1,22	1,70	2,76	-	1,41	2,20	3,03	-	-	-	-	1,23	1,87	2,51	1,12	1,64	-	
	MOTORE MOTOR		120Nm	250Nm	500Nm	120Nm	250Nm	500Nm	750Nm	120Nm	250Nm	500Nm	750Nm	250Nm	500Nm	750Nm	250Nm	500Nm	750Nm
	ALBERO POLE		140mm	140mm	140mm	140mm	140mm	140mm	140mm	140mm	140mm	140mm	170mm	170mm	170mm	170mm	170mm	170mm	
	Ø ASSE Ø AXIS		30 mm																

b PROFONDITÀ TRA IL BORDO E IL LATO SUPERIORE DEL CARABOTTINO
 depth between the level surface and the upper side of the duckboarding

ROLLINSIDE 2 STRANE

ZA OBRAČUN KRAJNE CENE
 TO CALCULATE THE FINAL PRICE

1 + 2 + 3 + 4 + 5

Dimežije bazena u m do / Pool size in m up to	3,00x20,00		4,00x20,00		5,00x20,00		6,00x20,00	
	šifra	cena	šifra	cena	šifra	cena	šifra	cena
1 MEHANIKA: komadi za zid ili set za zid, vratilo i motor / mechanics pieces to wall or masonry kit, pole and motor								
Komadi za zid-zidno fiksiranje/Pieces to wall - fixing to wall	5060170	538,90 €	5060170	538,90 €	5060170	538,90 €	5060170	538,90 €
Motor 120 Nm/Motor 120 Nm	140 mm	5060199	9.801,20 €	5060200	9.938,50 €	5060201	10.408,70 €	-
Motor 250 Nm/Motor 250 Nm	140 mm	5060159	11.497,70 €	5060202	11.635,00 €	5060203	11.918,20 €	-
	170 mm	-	-	-	-	5060204	12.811,60 €	5060205
Motor 500 Nm/Motor 500 Nm	140 mm	5060198	15.280,30 €	5060211	15.414,40 €	5060212	15.700,80 €	-
	170 mm	-	-	-	-	5060213	16.225,10 €	5060214
Motor 750 Nm/Motor 750 Nm	140 mm	-	-	5060220	19.193,80 €	5060221	19.478,70 €	-
	170 mm	-	-	-	-	5060222	20.075,80 €	5060223
2 LAME / slats: PREZZO DA MOLTIPLICARE PER LA LUNGHEZZA DELLA VASCA / PRICE TO MULTIPLE FOR THE LENGTH OF THE POOL								
Lamele PVC mat belo /White opaque PVC slats	5060008	-	5060009	-	5060011	-	5060013	-
Lamele PVC mat pesak/Sand opaque PVC slats	5060016	264,20 €	5060017	347,80 €	5060019	437,60 €	5060021	509,50 €
Lamele PVC mat sivo/Grey opaque PVC slats	5060024	-	5060025	-	5060027	-	5060029	-
Lamele PVC sv.plava mat/Light blue opaque PVC slats	5060032	276,60 €	5060033	415,40 €	5060035	480,90 €	5060037	532,30 €
Lamele L84 PVC bela ili mat siva L84 PVC slats white or gray matte	5060587	237,90 €	5060589	313,00 €	5060591	393,90 €	-	-
Lamele polikarbonat solarni / Polycarbonate solar slats	5060046	878,20 €	5060047	1.074,10 €	5060049	1.350,80 €	5060051	1.632,20 €
3 SETA ZA KAČENJE PUSHLOCK / Pushlock coupling kit – CENU MNOŽITI SA BROJEM DODELJENIH KOMADA / Price to be multiplied by the number of pieces assigned								
Zidni/To wall Cod.5061010 Pojedinačna cena 91,00 € KOL :	4		6		6		8	
Nošač ili visoki nosač/Rider or high rider Cod.5061011 / 5061012 Prezzo singolo 162,80 € KOL :	4		6		6		8	
4 GREDE/ beams								
Zidni komadi za grede-zidno fiksiranje/Beams support - fixing to wall	5060237	323,80 €	5060237	323,80 €	5060237	323,80 €	5060237	323,80 €
Grede/Beams	5060262	3.701,90 €	5060263	4.299,00 €	5060264	4.877,20 €	5060265	5.111,60 €
5 REŠETKI / duckboarding								
REŠETKA PVC/PVC duckboarding	5060266	3.012,80 €	5060267	4.017,10 €	5060268	5.021,30 €	5060269	6.025,60 €
Rešetka za oblaganje/Duckboarding to coat	5060270	4.961,10 €	5060271	6.614,80 €	5060272	8.268,50 €	5060273	9.922,20 €

ROLLEASY 2



KARAKTERISTIKE

1. **TERMINALI**
 - Od aluminijuma 3 mm lakirano belo
2. **MOTORIZACIJA (ZA ELEKTRIČNU I SOLARNU VERZIJU)**
 - Vek trajanja motora je omogućen pouzdanijim zahvaljujući ležajevima koji podržavaju kardan i tako težinu prekrivke.
 - Cevni električni Motor, 4 obrtaja u minuti
 - Razvodna električna kutija sa transformatorom 200 VA, zaštitna putem magnetno termičkog zaštitnog prekidača.
 - Upravljanje putem tastera na ključ. Isporuka sa dva ključa.
3. **RUČNA VERZIJA**
 - Uklonjivi ručni volan
 - Prenosna kutija od 15/1 sa kugličnim ležajevima inox sa strane volana za lakše upravljanje
4. **ANODIZIRANI KARDAN 20 MIKRONA**
5. **LAMELE**
 - Lamele PVC mat ili solarni polikarbonat
- **SET ZA KAČENJE Pushlock**

Nadzemna prekrivka ROLLEASY 2 odgovara bazenima od 2x3 m do 8 x7,50 m. Na raspolaganju **električna** varijanta, solarana verzija (za bazene do 5x11m), isporuka sa dve baterije, 1 solarni panel, sa fotovoltaičkim ćelijama i odgovarajućim ožičenjem. Na raspolaganju **takođe ručna** verzija sa tranzmisionom kutijom koja omogućava namotavanje i odmotavanje roletne bez napora. **Može se** personalizovati birajući boje terminala. Kardan je podržan ležajevima.

The above ground cover ROLLEASY 2 fits pools 2x3 m up to 8x7,50 m. Available in electric version, solar version (for pools up to 5x11m), delivered with 2 batteries, 1 solar panel with photovoltaic cells and an adapted wiring. Also available in manual version with the transmission box that allows a wrapping and unrolling of the cover without effort. Customizable choosing the color of the terminals. Pole supported by bearings.

FEATURES

1. **TERMINALS**
 - 3 mm white lacquered aluminum
2. **MOTORIZATION (electric and solar version)**
 - The longevity of the engine is made more reliable thanks to the bearings that support the pole and therefore the weight of the cover
 - Low-voltage electric tubular motor, 4 rounds per minute
 - Electric control panel with 200 VA transformer, protection by thermal magneto circuit breaker
 - Command by key button. Delivered with 2 keys
3. **MANUAL VERSION**
 - Manual removable steering wheel
 - Transmission box 15/1 with ball bearings inox on the wheel side to facilitate handling
4. **ANODIZED POLE 20 MICRONS**
5. **SLATS**
 - Opaque PVC or solar polycarbonate slats
- **HOOKING KIT**
 - Pushlock



3. Ručna verzija sa ručnim uklonjivim volanom.
Manual version with manual removable steering wheel.

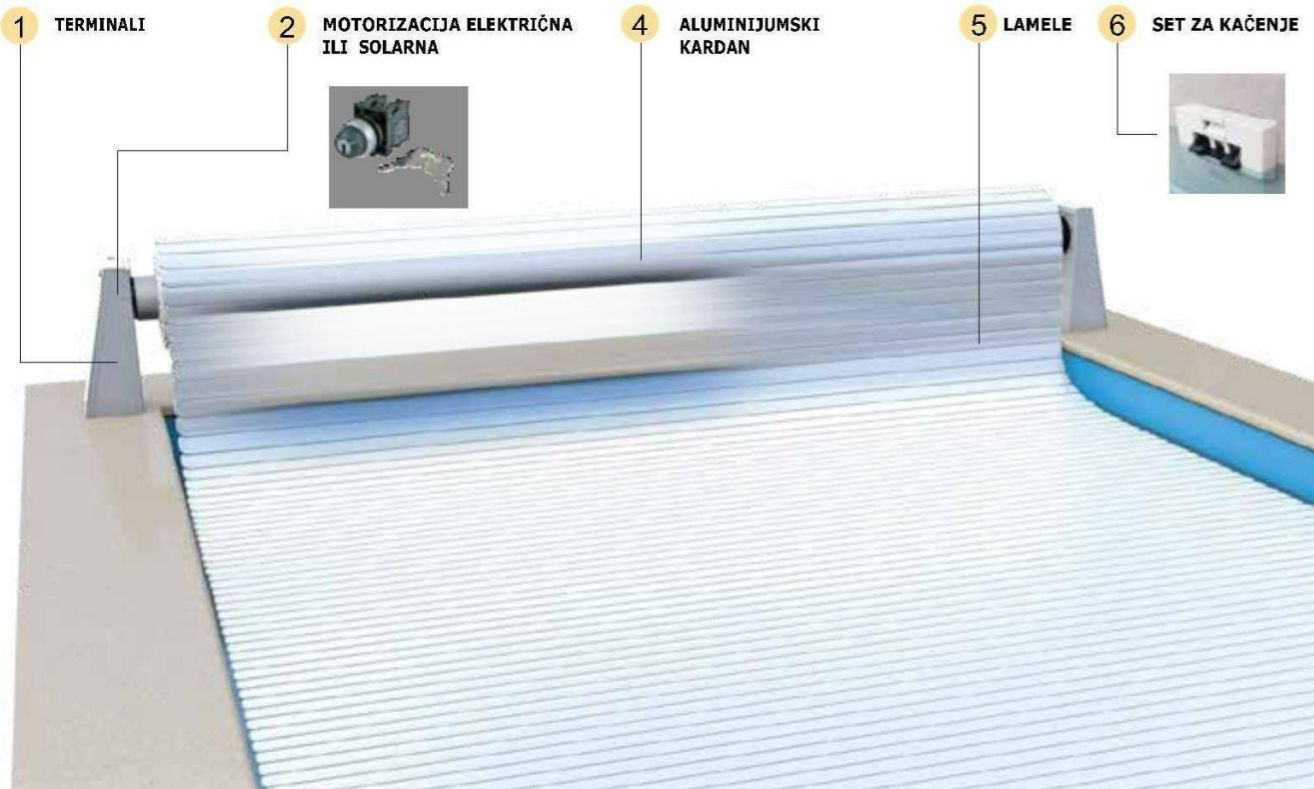

SET ROLETNA MODEL ROLLEASY2 električna STANDARD

Komplet roletna podrazumevati u formuli standard: mehanika, lamele prekrivke u bojama bela/pesak/sivo, beli graničnici, sigurnosne kuke pushlock rider.

Roller shutter kit in the standard formula: mechanics, cover blades in white / sand / gray, white terminals, pushlock safety hooks.

opis	šifra	cena
Roletna za bazen 7,00 x 3,00 m	5060163	6.185,00 €
Roletna za bazen 8,00 x 4,00 m	5060164	7.733,00 €
Roletna za bazen 9,00 x 4,00 m	5060165	8.081,00 €
Roletna za bazen 10,00 x 4,00 m	5060166	8.429,00 €
Roletna za bazen 10,00 x 5,00 m	5060167	9.684,00 €
Roletna za bazen 12,00 x 5,00 m	5060168	10.559,00 €
Roletna za bazen 12,00 x 6,00 m	5060169	14.331,00 €

Opcije scala romana	šifra	cena
Rimske stepenice radijus do 1,50 m con lame PVC bianco opaco	5060076	672,70 €
Rimeske stepenice radijus do 1,50 m con lame PVC sabbia opaco	5060077	672,70 €
Rimske stepenice radijus do 1,50 m con lame PVC grigio opaco	5060078	672,70 €

**ZADODATNE MODELESKALAPOGLEDATI TABELUNA DNUOGLAVLJA ROLETNI PREKRIVKI
FOR FURTHER STAIRS MODELS, SEE TABLE AT THE BOTTOM OF THE SHUTTER COVERS CHAPTER**

**Personalizuj graničnike birajući između sledećih boja
Customize the terminals choosing between the following colors**



Pesak
sand
(RAL 1015)



Svetlo siva
light grey
(RAL 7040)



zelena
green
(RAL 6005)



tamno siva
dark grey
(RAL 7016)



crna
black
(RAL9005)

OPCIJE / OPTIONS

Šifra/code	Opcija Rolleasy2 / option rolleasy2	Cena/price
5061009	Kontakt stop elektrolize* Electrolysis stop contact*	311,10 €

* Samo za Rolleasy 2 električnu
/ For Rolleasy 2 electric only

ROLLEASY 2
Električna ili solarna
electric or solar

ZA OBRAČUN FINALNE CENE
TO CALCULATE THE FINAL PRICE

1 + 2 + 3

ROLLEASY 2 ELEKTRIČNA / ROLLEASY 2 ELECTRIC

Dim.bazena u m do/Pool size in m up to	2,00x15,50	2,50x15,50	3,00 x 15,50	3,50 x 14,50	4,00 x 14,00	4,50 x 12,50	5,00x 13,50	5,00x20,50	6,00 x 15,00	7,00 x 18,50	8,00 x 14,00
1 MEHANIČKA: vratilo, motor i terminali / mechanics: pole, motor and terminals											
Visina osovine / Height to the axis	H 32	H 32	H 32	H 32	H 32	H 32	H 32	H 37	H 37	H 37	H 37
Rolleasy 2 terminali bianchi Rolleasy 2 white terminals	5060276	5060277	5060280	5060281	5060282	5060283	5060284	5060285	5060286	5060287	5060288
	3.546,40 €	3.649,30 €	3.684,20 €	3.859,50 €	3.973,50 €	4.090,20 €	4.331,00 €	8.363,80 €	6.914,50 €	8.456,20 €	9.873,90 €
Rolleasy 2 terminali colorati Rolleasy 2 colored terminals	5060278	5060279	5060289	5060290	5060291	5060292	5060293	5060294	5060295	5060296	5060297
	3.937,60 €	4.061,20 €	4.102,30 €	4.280,80 €	4.396,40 €	4.517,90 €	4.746,00 €	8.569,80 €	7.190,10 €	8.662,20 €	10.003,80 €
2 LAMELE / slats: CENU MNOŽITI SA DUŽINOM BAZENA / PRICE TO MULTIPLE FOR THE LENGTH OF THE POOL											
Lamele PVC belo mat White opaque PVC slats	5060562	5060572	5060008	5060298	5060009	5060010	5060011	5060011	5060013	5060014	5060015
Lamele PVC pesak mat Sand opaque PVC slats	5060563	5060573	5060016	5061117	5060017	5060018	5060019	5060019	5060021	5060022	5060023
Lamele PVC sivo mat Grey opaque PVC slats	5060564	5060574	5060024	5062225	5060025	5060026	5060027	5060027	5060029	5060030	5060031
	249,30 €	257,70 €	264,20 €	314,70 €	347,80 €	387,20 €	437,60 €	437,60 €	509,50 €	564,00 €	633,10 €
Lamele PVC sv.plavo mat Light blue opaque PVC slats	5060565	5060575	5060032	5060033	5060582	5060034	5060035	5060035	5060037	5060038	5060039
	258,00 €	269,60 €	276,60 €	411,30 €	415,40 €	442,30 €	480,90 €	480,90 €	532,30 €	602,70 €	674,10 €
Lamele L84 PVC belo ili sivo mat / L84 PVC slats white or gray matte	5060585	5060586	5060587	5060588	5060589	5060590	5060591	5060591	-	-	-
	205,30 €	225,20 €	237,90 €	283,20 €	313,00 €	348,50 €	393,90 €	393,90 €	-	-	-
Lamele polikarbonat solarni Polycarbonate solar slats	5060566	5060576	5060046	5060583	5060047	5060584	5060049	5060049	5060051	5060143	5060144
	698,60 €	790,50 €	878,20 €	966,70 €	1.074,10 €	1.283,20 €	1.577,40 €	1.350,80 €	1.632,20 €	1.898,80 €	2.175,40 €
3 Komplet kačenja PUSHLOCK / Pushlock coupling kit CENU MNOŽITI SA BROJEM DATIH KOMADA / Price to be multiplied by the number of pieces assigned											
Zidni/to wall							5061010				
Kom.cena/ single price							91,00 €				
Količina / quantity	4	4	4	6	6	6	6	6	8	8	10
Pokr.nosač / rider pokretni/high rider Komadna cena / single price							5061011 5061012				
							162,80 €				
Količina / quantity	4	4	4	6	6	6	6	6	8	8	10

ROLLEASY 2 SOLAR / ROLLEASY 2 SOLAR

Dimenzije bazena u m do/Pool size in m up to	2,00x15,50	2,50x15,50	3,00 x 15,50	3,50 x 14,50	4,00 x 13,50	4,50 x 12,00	5,00 x 11,00	
1 MEHANIČKA: vratilo, motor e terminali / mechanics: pole, motor and terminals								
Visina osovine Height to the axis	H 32	H 32	H 32	H 32	H 32	H 32	H 32	
Rolleasy 2 terminali beli Rolleasy 2 white terminals	5060348	5060349	5060303	5060304	5060305	5060306	5060307	
	4.126,10 €	4.249,70 €	4.290,80 €	4.477,20 €	4.542,20 €	4.689,00 €	4.899,60 €	
Rolleasy 2 terminala obojena Rolleasy 2 colored terminals	5060357	5060358	5060308	5060309	5060310	5060311	5060312	
	4.480,90 €	4.625,10 €	4.672,60 €	4.860,60 €	4.935,00 €	5.085,00 €	5.283,00 €	
2 LAMELE / slats: CENU MNOŽITI SA DUŽINOM BAZENA / PRICE TO MULTIPLE FOR THE LENGTH OF THE POOL								
Lamele PVC mat belo White opaque PVC slats	5060562	5060572	5060008	5060298	5060009	5060010	5060011	
Lamele PVC pesak mat Sand opaque PVC slats	5060563	5060573	5060016	5061117	5060017	5060018	5060019	
LameLE PVC MAT SIVO Grey opaque PVC slats	5060564	5060574	5060024	5062225	5060025	5060026	5060027	
	249,30 €	257,70 €	264,20 €	314,70 €	347,80 €	387,20 €	437,60 €	
Lamele PVC sv.plavo mat Light blue opaque PVC slats	5060565	5060575	5060032	5060033	5060582	5060034	5060035	
	258,00 €	269,60 €	276,60 €	411,30 €	415,40 €	442,30 €	480,90 €	
Lamele L84 PVC belo ili sivo mat L84 PVC slats white or gray matte	5060585	5060586	5060587	5060588	5060589	5060590	5060591	
	205,30 €	225,20 €	237,90 €	283,20 €	313,00 €	348,50 €	393,90 €	
Lamele polikarbonat solarni Polycarbonate solar slats	5060566	5060576	5060046	5060583	5060047	5060584	5060049	
	698,60 €	790,50 €	878,20 €	966,70 €	1.074,10 €	1.283,20 €	1.350,80 €	
3 Komplet kačenja PUSHLOCK / Pushlock coupling kit CENU MNOŽITI SA BROJEM DATIH KOMADA / Price to be multiplied by the number of pieces assigned								
Zidni/to wall							5061010	
Cena / komad/single price							91,00 €	
Količina / quantity	4	4	4	6	6	6	6	
Pokr.nosač / rider Visoki nosač / high rider Cena po komadu/single price							5061011 5061012	
							162,80 €	
Količina / quantity	4	4	4	6	6	6	6	

ROLLEASY 2
manuale
manual

PER CALCOLARE IL PREZZO FINALE
TO CALCULATE THE FINAL PRICE

1 + 2 + 3

ROLLEASY 2 MANUALE / ROLLEASY 2 MANUAL

Dimensioni piscina in m fino a/Pool size in m up to	2,00x15,50	2,50x15,50	3,00x15,50	3,50x14,50	4,00x13,50	4,50x12,00	5,00x11,00
1 MECCANICA: albero e terminali / mechanics: pole and terminals							
Altezza all'asse Height to the axis	H 32	H 32	H 32	H 32	H 32	H 32	H 32
Rolleasy 2 terminali bianchi Rolleasy 2 white terminals	5060366 2.423,30 €	5060367 2.488,20 €	5060313 2.510,40 €	5060314 2.647,70 €	5060315 2.720,60 €	5060316 2.821,40 €	5060317 2.900,60 €
Rolleasy 2 terminali colorati Rolleasy 2 colored terminals	5060368 2.873,20 €	5060369 2.958,70 €	5060318 2.987,20 €	5060319 3.129,20 €	5060320 3.208,40 €	5060321 3.315,60 €	5060322 3.388,50 €
2 LAME / slats: PREZZO DA MOLTIPLICARE PER LA LUNGHEZZA DELLA VASCA / PRICE TO MULTIPLE FOR THE LENGTH OF THE POOL							
Lame PVC bianco opaco White opaque PVC slats	5060562	5060572	5060008	5060298	5060009	5060010	5060011
Lame PVC sabbia opaco Sand opaque PVC slats	5060563	5060573	5060016	5061117	5060017	5060018	5060019
Lame PVC grigio opaco Grey opaque PVC slats	5060564 249,30 €	5060574 257,70 €	5060024 264,20 €	5062225 314,70 €	5060025 347,80 €	5060026 387,20 €	5060027 437,60 €
Lame PVC azzurro opaco Light blue opaque PVC slats	5060565 258,00 €	5060575 269,60 €	5060032 276,60 €	5060033 411,30 €	5060582 415,40 €	5060034 442,30 €	5060035 480,90 €
Lame L84 PVC bianco o grigio opaco L84 PVC slats white or gray matte	5060585 205,30 €	5060586 225,20 €	5060587 237,90 €	5060588 283,20 €	5060589 313,00 €	5060590 348,50 €	5060591 393,90 €
Lame policarbonato solari Polycarbonate solar slats	5060566 698,60 €	5060576 790,50 €	5060046 878,20 €	5060583 966,70 €	5060047 1.074,10 €	5060584 1.283,20 €	5060049 1.350,80 €
3 KIT DI AGGANCIO PUSHLOCK / Pushlock coupling kit							
PREZZO DA MOLTIPLICARE PER IL NUMERO DI PEZZI ASSEGNATI / Price to be multiplied by the number of pieces assigned							
Da murare/to wall	5061010						
Prezzo singolo/ single price	91,00 €						
Quantità / quantity	4	4	4	6	6	6	6
Cavaliere / rider cavaliere alto / high rider	5061011 5061012						
Prezzo singolo/ single price	162,80 €						
Quantità / quantity	4	4	4	6	6	6	6

**KARAKTERISTIKE****1. GRANIČNICI****2 dimenzije graničnika:**

- Visina od osi 32 cm (za bazene do 5x13,50 m)
- Visina od osi 42 cm (za bazene do 10x20,50 m)

Panel od aluminijuma

- Obojen sivo metal
- Izvanredna otpornost na udare i ogrebotine
- Duga UV trajnost.

Podestivi nogari koji omogućuju podestivost nivoa graničnika u slučaju neravnih ivica.

2. MOTORIZACIJA**Električna verzija**

- Podestivi mehanički graničnici, motore se može mehanički isključiti (omogućava da se roletna otvori u slučaju kvara i osigurati bazen iako nema struje).
- Dugovečnost motora je omogućena zahvaljujući ležajevima koji nose vratilo i težinu prekrivke.
- Motor cevast 12 V o 24 V

Solarna verzija

- Graničnik opremljen sa jednim ili tri solarna panela zavisno od veličine bazena.
- Upravljanje putem Wi-Key, kutijom sa ključem ili Live Pool, aplikacijom koja omogućava otvaranje i zatvaranje prekrivke preko Smartphone, koji se koristi kao dopunainstalacije Wi-Key ili kutije sa ključem.

3. ELOKSIRANO ALUMINIJUMSKO VRATILO 20 MICRONS**4. LAMELE**

- Lamele PVC mat ili polikarbonat solarni.

5. KOMPLET ZA KAČENJE

- Pushlock

FEATURES**1. TERMINALS****2 terminals dimensions:**

- Height at the axis 32 cm (for pools up to 5x13,50 m)
- Height at the axis 42 cm (for pools up to 10x20,50 m)

Aluminum frame

- Tinted metallic grey
- Excellent resistance to shocks and scratches
- Long life to UV

Adjustable feet that allow you to adjust the level of the terminals in case of curved edges.

2. MOTORIZATION**Electric tubularmotor**

- Adjustable mechanical limit switch, *motor mechanically disengageable (it allows to unroll the cover in case of failure and to secure the pool despite the absence of electricity).*
- The longevity of the motor is made more reliable thanks to the bearings that support the pole and the weight of the cover.
- 12 V or 24 V tubularmotor

Solar version

- Terminal equipped with one or three solar panels according to the dimensions of the pool.
- Control by Wi-Key, box key or Live Pool, application allowing the opening and closing of the cover via Smartphone, to be used in addition to the installation of the Wi-Key or the box key.

3. ALUMINIUM ANODIZED POLE 20 MICRONS**4. SLATS**

- Opaque PVC or solar polycarbonate slats.

5. HOOKING KIT

- Pushlock

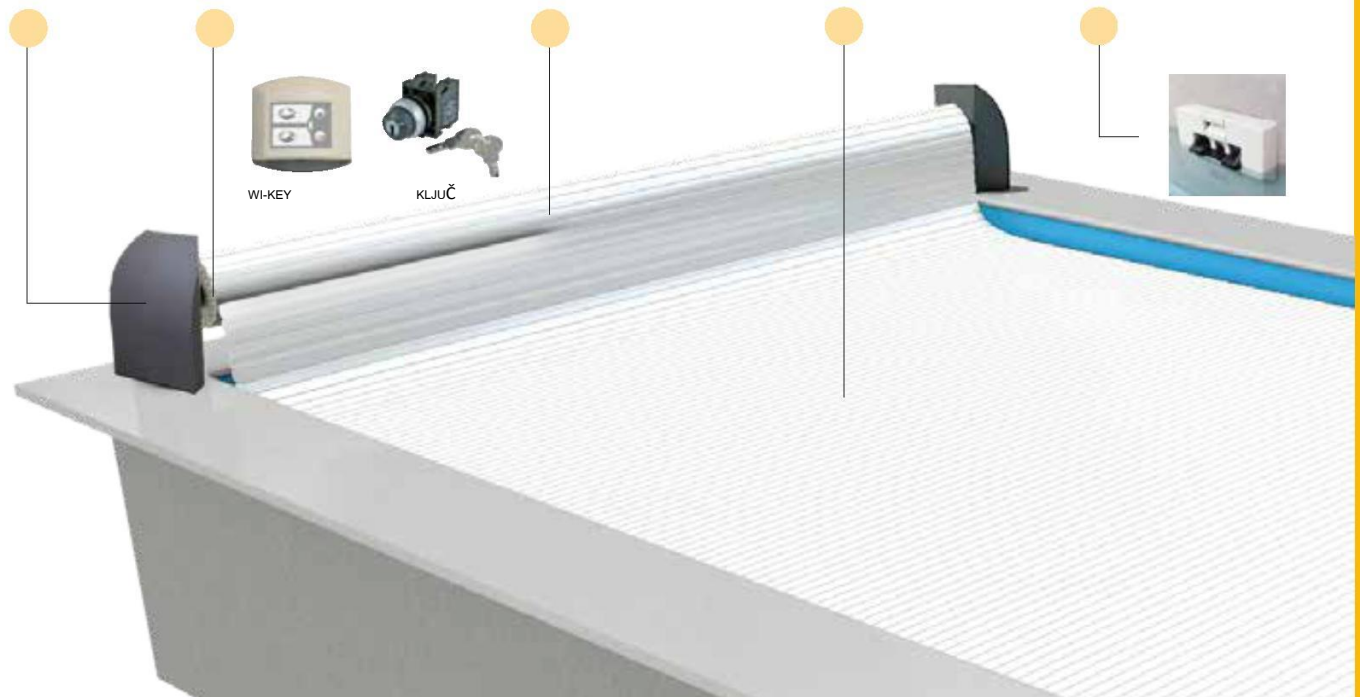

SET ROLETNA MODEL CONTURA ELEKTRIČNA STANDARD

KOMPLET ROLETNAda podrazumeva se u formi standard: mehanika, lamele prekrivke u bojama belo/pesak/sivo, sigurnosne kuke pushlock rider.

Roller shutter kit in the standard formula: mechanical, cover blades in white / sand / gray, pushlock safety hooks.

Opis/description	Šifra/code	Cena/price
Roletna za bazen 7,00 x 3,00 m	5060171	8.026,00 €
Roletna za bazen 8,00 x 4,00 m	5060172	9.821,00 €
Roletna za bazen 9,00 x 4,00 m	5060173	10.169,00 €
Roletna za bazen 10,00 x 4,00 m	5060174	11.516,00 €
Roletna za bazen 10,00 x 5,00 m	5060175	11.937,00 €
Roletna za bazen 12,00 x 5,00 m	5060176	12.812,00 €
Roletna za bazen 12,00 x 6,00 m	5060177	20.083,00 €
Opcija scala romana		
Rimske stepenice radijus do 1,50 m sa lamelama PVC belo mat	5060076	672,70 €
Rimske stepenice radijus do 1,50 m con lame PVC pesak mat	5060077	627,70 €
Rimske stepenice radijus do 1,50 m con lame PVC sivo mat	5060078	627,70 €

**ZAVIŠE MODELA STEPENICA VIDETI TABELU NADNUODELJKAROLETNA PREKRIVKI
FOR FURTHER STAIRS MODELS, SEE TABLE AT THE BOTTOM OF THE SHUTTER COVERS CHAPTER**

OPCIJE / OPTIONS

Šifra/ code	Opcije Contura / option contura	Cena/price
5 061002	Predajnik Wi-Key dodatni — omogućava instaliranje max 3 odašiljača po prijemniku Additional transmitter Wi-KEY - it allows to install max 3 transmitters for every receptor	422,50 €
5 061003	Panel daljinskog prijemnika Wi-Key (samo za motore od 250 Nm) Neophodan ako je odašiljač instaliran Vrlo daleko od prijemnika ili ako neka zgrada ometa prolaz radio talasa. Remote panel receptor Wi-Key (only for 250 Nm motors) Remote panel receptor Wi-Key - necessary if the transmitter is installed in a place very far from the receiver or if a building disturbs the passage of radio waves	169,50 €
5 061008	Automatski prekidač za stop 12 V Automatic stop switch 12 V	232,10 €
5 061009	Elektrolizni*stop kontakt Electrolysis stop contact*	311,10 €

CONTURA
Električna i solarna
electric or solar

ZA OBRAČUN KRAJNE CENE
TO CALCULATE THE FINAL PRICE

1 + 2 + 3

CONTURA ELEKTRIČNA / CONTURA ELECTRIC

Dimenzije bazena u m fino a/ Pool size in m up to	3,00x15,50	3,50x14,50	4,00x14,00	4,50x12,50	5,00x13,50	6,00x26,50	7,00x24,50	8,00x24,00	9,00x22,50	10,00x20,50
1 MEHANIKA / mechanics										
Visina osovine Height to the axis	H 32	H 32	H 32	H 32	H 32	H 42	H 42	H 42	H 42	H 42
Vratilo, motor i terminali Pole, motor and terminals Rolleasy 2 white terminals	5060323 5.329,10 €	5060325 5.608,80 €	5060324 5.829,00 €	5060326 6.000,20 €	5060327 6.351,80 €	5060328 12.434,40 €	5060329 12.524,60 €	5060330 17.773,90 €	5060331 17.773,90 €	5063338 17.894,30 €
2 LAMELE / slats: MNOŽITI CENU SA DUŽINOM BAZENA / PRICE TO MULTIPLE FOR THE LENGTH OF THE POOL										
Lamele PVC bela mat White opaque PVC slats	5060008	5060298	5060009	5060010	5060011	5060013	5060014	5060015	5060126	5060132
Lamele PVC pesak mat Sand opaque PVC slats	5060016	5061117	5060017	5060018	5060019	5060021	5060022	5060023	5060127	5060137
Lamele PVC sivo mat Grey opaque PVC slats	5060024 264,20 €	5062225 314,70 €	5060025 347,80 €	5060026 387,20 €	5060027 437,60 €	5060029 509,50 €	5060030 564,00 €	5060031 633,10 €	5060128 698,50 €	5060142 786,50 €
Lamele PVC sv.plava mat Light blue opaque PVC slats	5060032 276,60 €	5060033 411,30 €	5060582 415,40 €	5060034 442,30 €	5060035 480,90 €	5060037 532,30 €	5060038 602,70 €	5060039 674,10 €	5060129 801,80 €	5060149 969,70 €
Lamele L84 PVC belo ili sivo mat L84 PVC slats white or gray matte	5060587 237,90 €	5060588 283,20 €	5060589 313,00 €	5060590 348,50 €	5060591 393,90 €	-	-	-	-	-
Lamele polikarbonat solarni / Polycarbonate solar slats	5060046 878,20 €	5060583 966,70 €	5060047 1.074,10 €	5060584 1.283,20 €	5060049 1.350,80 €	5060051 1.632,20 €	5060143 1.898,80 €	5060144 2.175,40 €	5060148 2.443,90 €	5060146 2.822,30 €
3 SETA ZA KAČENJE PUSHLOCK / Pushlock coupling kit CENU MNOŽITI SA Pbrojem datih komada/ Price to be multiplied by the number of pieces assigned										
Zidni/to wall						5061010				
Pojedinačna cena/single price						91,00 €				
Količina / quantity	4	6	6	6	6	8	8	10	10	10
Pokr.nosač / rider Gornji nosač/highrider						5061011 5061012				
Pojedinačna cena/ single price						162,80 €				
Količina / quantity	4	6	6	6	6	8	8	10	10	10

CONTURA SOLARE / CONTURA SOLAR

Dimenzije bazena u m do/Pool size in m up to	3,00x15,50	3,50x14,50	4,00x13,50	4,50x12,00	5,00x11,00	6,00x12,50	7,00x8,50	
1 MEHANIKA / mechanics								
Visina do osovine Height to the axis	H 32	H 32	H 32	H 32	H 32	H 42	H 42	
Vratilo, motor i terminali Pole, motor and terminals Rolleasy 2 white terminals	5060333 6.597,80 €	5060338 6.769,90 €	5060334 6.866,50 €	5060332 7.001,20 €	5060335 7.181,80 €	5060336 8.987,60 €	5060337 10.615,80 €	
2 LAMELE / slats: CENU MNOŽITI SA DUŽINOM BAZENA / PRICE TO MULTIPLE FOR THE LENGTH OF THE POOL								
Lamele PVC belo mat White opaque PVC slats	5060008	5060298	5060009	5060010	5060011	5060013	5060014	
Lamele PVC pesak mat Sand opaque PVC slats	5060016	5061117	5060017	5060018	5060019	5060021	5060022	
Lamele PVC sivo mat Grey opaque PVC slats	5060024 264,20 €	5062225 314,70 €	5060025 347,80 €	5060026 387,20 €	5060027 437,60 €	5060029 509,50 €	5060030 564,00 €	
Lamele PVC sv.plava mat Light blue opaque PVC slats	5060032 276,60 €	5060033 411,30 €	5060582 415,40 €	5060034 442,30 €	5060035 480,90 €	5060037 532,30 €	5060038 602,70 €	
Lamele L84 PVC belo ili sivo mat L84 PVC slats white or gray matte	5060587 237,90 €	5060588 283,20 €	5060589 313,00 €	5060590 348,50 €	5060591 393,90 €	-	-	
Lamele polikarbonat solarni / Polycarbonate solar slats	5060046 878,20 €	5060583 966,70 €	5060047 1.074,10 €	5060584 1.283,20 €	5060049 1.350,80 €	5060051 1.632,20 €	5060143 1.898,80 €	
3 SETA ZA KAČENJE PUSHLOCK / Pushlock coupling kit CENU MNOŽITI SA BROJEM DATIH KOMADA / Price to be multiplied by the number of pieces assigned								
Zidni/to wall					5061010			
Cena po kom/ single price					91,00 €			
Količina / quantity	4	6	6	6	6	8	8	
Pokr.nosač / rider Gornji nosač/highrider					5061011 5061012			
Cena po kom/ single price					162,80 €			
Količina / quantity	4	6	6	6	6	8	8	

ROLLOVER



Nadzemna prekrivka ROLLOVER poseduje personalizovanu oblogu, finiš u drvetu IPÉ ili PVC. Podesna za bazene od 2,5x3 m do 6x14 m u finišu PVC ili 7x14 m u drvenom finišu. Na raspolaganju u električnoj i solarnoj verziji, ova zadnja isporučena sa dve baterije visokih performansi i solarnog panela sa fotovoltaičkim ćelijama.

The above ground cover ROLLOVER has a customizable coating, finishing IPÉ wood or PVC. It fits pools 2.5x3 m up to 6x14 m in PVC finishing or 7x10 m in wood finishing.

Available in electric version and solar version, this one delivered with 2 high performance batteries and solar panel with photovoltaic cells.

KARAKTERISTIKE

1. STRUKTURA

- Lukovi od čelika inox 316 L
- Krajna prirubnica od belog lakiranog aluminijuma.
- Krajna obrada u termoformiranom ABS-PMMA

2. KUĆIŠTE

- Lamele od PVC belog ili drvo IPÉ
- Letvice 2x2 na 45 stepeni koje se lako uklanjaju da bi se pristupilo roletni.

3. MOTORIZACIJA

Cevni električni motor

- Podesivi mehanički krajnji prekidači, sistem se mehanički isključuje (omogućava odmotavanje prekrivke u slučaju loma i tako se osigurava bazen i pored nestanka struje).

Električna komandna table sa transformatorom 200VA, zaštita putem magnetnotermičkog prekidača.

Automatski prekidač

Štampano kolo koje omogućava stopiranje otvaranja ako se detektuje neuobičajeni teret na roletni.

Upravljanje preo Wi-Key, kutije na ključ ili Live Pool, aplikacije koja omogućava otvaranje i zatvaranje prekrivke putem Smartphone, za korišćenje kao dopuna instalaciji Wi-Key ili kutije on/off na ključ..

4. ELOKSIRANO VRATILO 20 MIKRONA

5. LAMELE

- Lamele PVC mat ili solarni polikarbonat.

6. KOMPLET ZA KAČENJE

- Pushlock

FEATURES

1. STRUCTURE

- Arches in 316 L stainlesssteel
- End flange in white lacquered aluminum
- ABS-PMMA thermoformed finish

2. HOUSING

- White PVC or IPE wood slats
- 2 x2 slats 45 degrees easily removable to access the cover.

3. MOTORIZATION

Electric tubular motor

- Adjustable mechanical limits switches, mechanically disengage-able system (it allows to unroll the cover in case of breakage and so to secure the pool despite the absence of electricity

Electric control panel with 200VA transformer, protection by thermal-magnetic circuit breaker.

Automatic switch

Printed circuit that allows you to stop the opening after having detected an abnormal effort on the cover

Control by Wi-Key, box key or Live Pool, application allowing the opening and closing of the cover via Smartphone, to be used in addition to the installation of the Wi-Key or the box key.

4. 20 MICRONS ANODIZED POLE

5. SLATS

- Opaque PVC or solar polycarbonate slats.

6. HOOKING KIT

- Pushlock

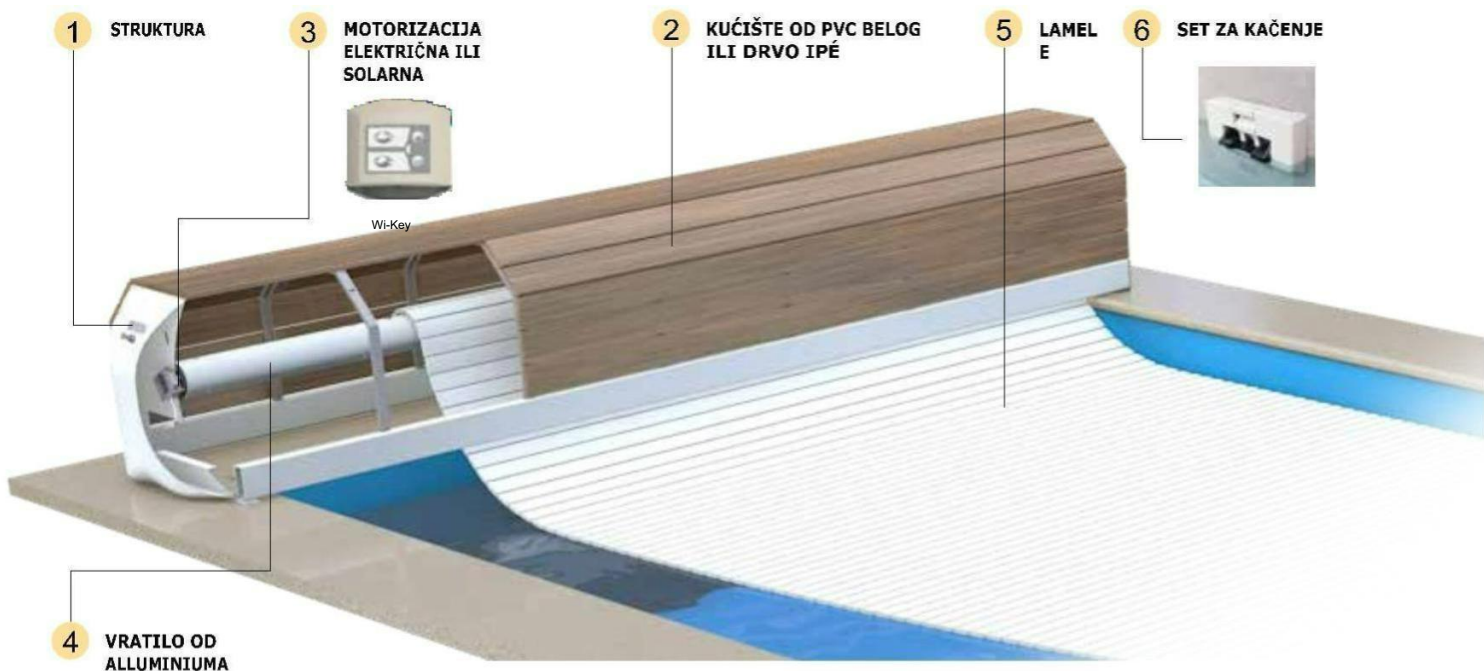

SET ROLETNA MODEL **ROLLOVER ELEKTRIČNI STANDARD**

Komplet Roletna podrazumevati u formuli standard: mehanika, lamele prekrivke u bojama belo/pesak/sivo, kućište od PVC belo, sigurnosno **kačenje** pushlock pokretni **noslač**.

Roller shutter kit in the standard formula: mechanical, cover blades in white / sand / gray, housing in white PVC, pushlock safety hooks.

Opis/description	Šifra/code	Cena/price
Roletna za bazen 7,00 x 3,00 m	5060178	14.244,00 €
Roletna za bazen 8,00 x 4,00 m	5060179	15.541,00 €
Roletna za bazen 9,00 x 4,00 m	5060180	15.889,00 €
Roletna za bazen 10,00 x 4,00 m	5060181	16.236,00 €
Roletna za bazen 10,00 x 5,00 m	5060182	18.132,00 €
Roletna za bazen 12,00 x 5,00 m	5060184	19.008,00 €
Roletna za bazen 12,00 x 6,00 m	5060185	21.907,00 €
Opcija rimske stepenice		
Rimske stepenice radijus do 1,50 m con lame PVC bianco opaco	5060076	672,70 €
Rimske stepenice poluprečnik do 1,50 m sa lamelama PVC pesak mat	5060077	672,70 €
Rimske stepenice prečnik do 1,50 m sa lamelama PVC sivo mat	5060078	672,70 €

**ZADODATNE MODELE STEPENICA VIDETI TABELUNA DNUPOGLAVLJA ROLETNA PREKRIVKI
FOR FURTHER STAIRS MODELS, SEE TABLE AT THE BOTTOM OF THE SHUTTER COVERS CHAPTER**

OPCIJE/ OPTIONS

Solarna verzija (drvo i belo) / Solar version (wood and white)

Šifra/code	Opcija Rollover / option rollover	Cena/price
5 061002	Odašiljač Wi-Key dodatni – omogućava instaliranje max 3 odašiljača po prijemu Additional transmitter Wi-KEY - it allows to install max 3 transmitters for every receptor	422,50 €
5 061009	Elektrolizni* stop kontakt Electrolysis stop contact*	311,10 €
5 061008	Automatski stop prekidač 12 V Automatic stop switch 12 V	232,10 €

* Samo za električni Rollover / For Rollover electric only

ROLLOVER
Električni ili solarni
electric or solar

ZA OBRAČUN KRAJNE CENE
TO CALCULATE THE FINAL PRICE

1 + 2 + 3

ROLLOVER ELEKTRIČNA / ROLLOVER ELECTRIC

Dimenzije bazena u m do /Pool size in m up to	2,00x14,00	3,00x14,00	4,00x14,00	5,00x14,00	6,00x14,00	7,00x14,00*
1 MEHANIKA: vratilo, motor i kućište / Mechanics: pole, motor and housing						
Kućište PVC PVC housing	5060384 11.945,40 €	5060388 12.069,00 €	5060340 12.269,50 €	5060341 13.267,50 €	5060342 15.141,40 €	- -
Kućište IPÉ IPÉ housing	5060385 13.958,70 €	5060389 14.272,30 €	5060343 14.663,00 €	5060344 16.197,90 €	5060345 18.819,50 €	5060346 25.779,50 €
2 LAMELE / slats: CENU MNOŽITI SA DUŽINOM BAZENA / PRICE TO MULTIPLE FOR THE LENGTH OF THE POOL						
Lamele PVC mat bele White opaque PVC slats	5060562	5060008	5060009	5060011	5060013	5060014
Lamele PVC mat pesak Sand opaque PVC slats	5060563	5060016	5060017	5060019	5060021	5060022
Lamele PVC mat sivo Grey opaque PVC slats	5060564 249,30 €	5060024 264,20 €	5060025 347,80 €	5060027 437,60 €	5060029 509,50 €	5060030 564,00 €
Lamele PVC sv.plavo mat Light blue opaque PVC slats	5060565 258,00 €	5060032 276,60 €	5060582 415,40 €	5060035 480,90 €	5060037 532,30 €	5060038 602,70 €
Lamele L84 PVC belo ili mat sivo L84 PVC slats white or gray matte	5060585 205,30 €	5060587 237,90 €	5060589 313,00 €	5060591 393,90 €	-	-
Lamele polikarbonat solarni Polycarbonate solar slats	5060566 698,60 €	5060046 878,20 €	5060047 1.074,10 €	5060049 1.350,80 €	5060051 1.632,20 €	5060143 1.898,80 €
3 SETA KAČENJA PUSHLOCK / Pushlock coupling kit CENU MNOŽITI SA BROJEM DATIH KOMADA / Price to be multiplied by the number of pieces assigned						
zidni/to wall				5061010		
Pojedinačna cena/single price				91,00 €		
Količina / quantity	2	2	3	3	4	4
Pokr.nosač / rider nosač visoki / high rider Cena kom/single price				5061011 - 5061012		
				162,80 €		
Količina / quantity	2	2	3	3	4	4

*Stepenice na širini od 7 metara/stair on the width of 7 meters

ROLLOVER SOLARNI / ROLLOVER SOLAR

Dimenzije bazena u m do /Pool size in m up to	2,00x14,00	3,00x14,00	4,00x14,00	5,00x14,00	6,00x14,00
1 MEHANIKA: vratilo, motor i kućište / Mechanics: pole, motor and housing					
Kućište PVC PVC housing	5060386 13.494,60 €	5060390 13.618,10 €	5060350 13.818,70 €	5060351 14.813,50 €	5060352 17.694,80 €
Kućište IPÉ IPÉ housing	5060387 15.590,20 €	5060391 15.903,80 €	5060353 16.294,50 €	5060354 17.839,00 €	5060355 21.491,70 €
2 LAMELE / slats: CENU MNOŽITI SA DUŽINOM BAZENA / PRICE TO MULTIPLE FOR THE LENGTH OF THE POOL					
Lamele PVC mat belo White opaque PVC slats	5060562	5060008	5060009	5060011	5060013
Lamele PVC mat pesak Sand opaque PVC slats	5060563	5060016	5060017	5060019	5060021
Lamele PVC mat sivo Grey opaque PVC slats	5060564 249,30 €	5060024 264,20 €	5060025 347,80 €	5060027 437,60 €	5060029 509,50 €
Lamele PVC mat svetlo plava Light blue opaque PVC slats	5060565 258,00 €	5060032 276,60 €	5060582 415,40 €	5060035 480,90 €	5060037 532,30 €
Lamele L84 PVC belo ili mat sivo L84 PVC slats white or gray matte	5060585 205,30 €	5060587 237,90 €	5060589 313,00 €	5060591 393,90 €	-
Lamele polikarbonat solarni Polycarbonate solar slats	5060566 698,60 €	5060046 878,20 €	5060047 1.074,10 €	5060049 1.350,80 €	5060051 1.632,20 €
3 SETA ZA KAČENJE PUSHLOCK / Pushlock coupling kit CENU MNOŽITI SA BROJEM DATIH KOMADA / Price to be multiplied by the number of pieces assigned					
Zidni To wall				5061010	
				91,00 €	
Količina / quantity	2	2	3	3	4
Pokr.nosač ili gornji Rider or high rider				5061011 - 5061012	
				162,80 €	
Količina / quantity	2	2	3	3	4

MOOVE'O SOLARE



Pokretna solarna prekrivka **MOOVE'O** odgovara bazenima slobodnog oblika, od 2x3 m do 5x11 m. Pravolinijsko ručno pomeranje bez šina. Nema potrebe ni za kakvom doradom, korišćenje je jednostavno i brzo pošto se isporučuje već montirana. Mogućnost usaglašavanja strukture **MOOVE'O** boji peska ili sivoj roletne.

The solar mobile cover **MOOVE'O** fits free form pools from 2x3 m to 5x11 m. Rectilinear manual movement without rails.

It does not require any work, the installation is simple and quick since it is delivered already assembled.

Possibility to harmonize the **MOOVE'O** structure at the sand or grey colours of the slats.



Belo
white

pesak
sand

sivo
grey

KARAKTERISTIKE

1. STRUKTURA

Graničnici

- Struktura in inox da 3 e 4 mm, laccata bianco, sabbia o grigio
- Carter in composito

Centralna greda

- Alluminio laccato
- Consente lo scorrimento dell'acqua verso lavasca

Solarni paneli

- Cellule fotovoltaiche ad alta prestazione per alimentare il motore

Točkici od plavog polimera ne ostavljaju tragove sa kočnicom

- Prednji točak: Ø 150 mm
- Zadnji točak: Ø 200 mm

Graničnik točkova napred i nazad

- Omogućava da se označi inicijalno pozicioniranje **Moove'O** za radnje otvaranja i zatvaranja bazena.

2. MOTORIZACIJA

Električni cevni motor

- Podesivi mehanički granični prekidač
- 2 baterije 12 Vcc, sa punjačem baterija

3. ELOKSIRANO ALUMINIJUMSKO VRATILO 20MICRONS

4. LAMELE

- Lamele Pvc mat ili solarni polikarbonat.

5. KOMPLET ZA KAČENJE

- Pushlock

FEATURES

1. STRUCTURE

Terminals

- Structure 3 and 4 mm stainless steel, lacquered white, sand or grey
- Composite carter

Central cross

- Lacquered aluminum
- It allows the water flow towards the pool

Solar panels

- High performance photovoltaic cells to power the motor
- **Wheels in blue polymer anti-track with brake**

- Front wheel: Ø 150 mm
- Behind wheel: Ø 200 mm

Stop wheels front and behind

- It allows to mark the initial placement of the **Moove'O** for the opening and closing operations of the pool

2. MOTORIZATION

Electric tubular motor

- Adjustable mechanical limit switches
- 2 batteries 12 Vcc, battery charger included

3. 20MICRONS ALUMINUM ANODIZED POLE

4. SLATS

- Opaque PVC or solar polycarbonate slats.

5. HOOKING KIT

- Pushlock

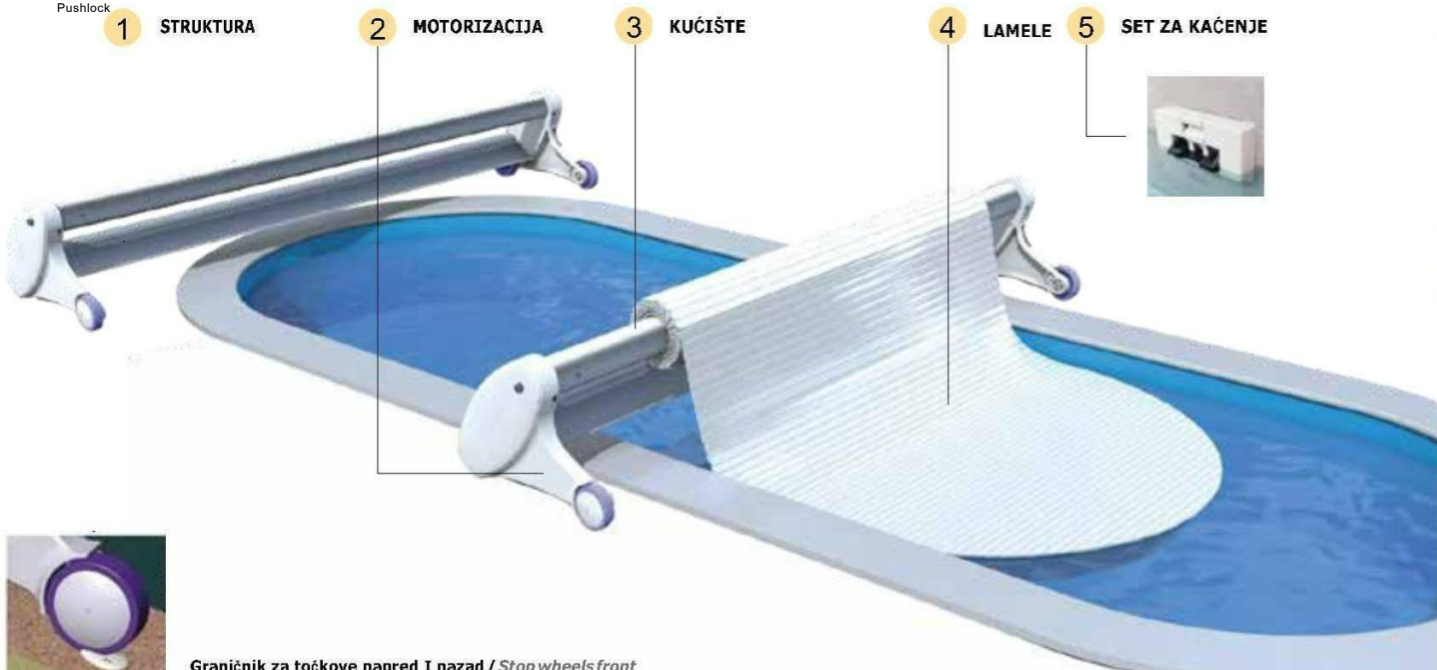

Graničnik za točkove napred i nazad / Stop wheels front

**MOOVE'O
SOLARE**

ZA OBRAČUN FINALNE CENE
TO CALCULATE THE FINAL PRICE

1 + 2 + 3

Dimenzije bazena u m do Pool size in m up to	2,00x12,00	2,50x12,00	3,00x12,00	3,50x12,00	4,00x12,00	4,50x11,00	5,00x11,00
Maksimalna kvota između točkova (m) Maximum quota between the wheels (m)	2,35	2,85	3,35	3,85	4,25	4,75	5,45
1 MEHANIKA: vratilo i motor /mechanics: pole and motor							
Moove'O bela White Moove'O	5060392 10.022,50 €	5060393 10.115,90 €	5060395 10.209,40 €	5060360 10.379,80 €	5060361 10.758,40 €	5060394 11.170,30 €	5060362 11.515,60 €
Moove'O bojena (pesak ili siva) Colored Moove'O (sand or grey)	5060396 10.407,40 €	5060397 10.500,80 €	5060399 10.594,30 €	5060363 10.764,70 €	5060364 11.140,10 €	5060398 11.548,90 €	5060365 11.895,80 €
2 LAMELE / slats: CENU MNOŽITI SA DUŽINOM BAZENA / PRICE TO MULTIPLE FOR THE LENGTH OF THE POOL							
Lamele PVC mat belo White opaque PVC slats	5060562 249,30 €	5060572 257,70 €	5060008 264,20 €	5060298 314,70 €	5060009 347,80 €	5060010 387,20 €	5060011 437,60 €
Lamele PVC pesak mat Sand opaque PVC slats	5060563 249,30 €	5060573 257,70 €	5060016 264,20 €	5061117 314,70 €	5060017 347,80 €	5060018 387,20 €	5060019 437,60 €
Lamele PVC mat sivo Grey opaque PVC slats	5060564 249,30 €	5060574 257,70 €	5060024 264,20 €	5062225 314,70 €	5060025 347,80 €	5060026 387,20 €	5060027 437,60 €
Lamele PVC svetlo plavo mat Light blue opaque PVC slats	5060565 258,00 €	5060575 269,60 €	5060032 276,60 €	5060033 411,30 €	5060582 415,40 €	5060034 442,30 €	5060035 480,90 €
Lamele L84 PVC belo ili mat sivo L84 PVC slats white or gray matte	5060585 205,30 €	5060586 225,20 €	5060587 237,90 €	5060588 283,20 €	5060589 313,00 €	5060590 348,50 €	5060591 393,90 €
Lamele policarbonat solarni Polycarbonate solar slats	5060566 698,60 €	5060576 790,50 €	5060046 878,20 €	5060583 966,70 €	5060047 1.074,10 €	5060584 1.283,20 €	5060049 1.350,80 €
3 SETA ZA KAČENJE PUSHLOCK / Pushlock coupling kit CENU Množiti sa brojem dodeljenih komada / Price to be multiplied by the number of pieces assigned							
Za zid/to wall				5061010			
Komadna cena/single price				91,00 €			
Količina / quantity	4	4	4	6	6	6	6
Nosač i visoki nosač Rider or high rider				5061011 5061012			
Količina / quantity	4	4	4	6	6	6	6

SET ROLETNI MODEL MOOVE'O SOLARNI STANDARD

Set roletne podrazumevaju se u formuli standard: mehanika, lamele bele boje/pesak/sivo,u kompletu sa sigurnosnim zakačaljka.

Roller shutter kits in the standard formula: mechanical, white / sand / gray blades, including safety hooks, without grating.

Opis/description	Šifra/code	Cena/price
Roletna za bazen 7,00 x 3,00 m	5060186	12.880,40 €
Roletna za bazen 8,00 x 4,00 m	5060191	14.192,00 €
Roletna za bazen 9,00 x 4,00 m	5060188	14.539,80 €
Opcije scala romana		
Scala romana radius do 1,50 m sa lamelama PVC mat bele	5060076	672,70 €
Scala romana radius do 1,50 m sa lamelama PVC pesak mat	5060077	672,70 €
Scala romana radius do 1,50 m sa lamelama PVC mat sivim	5060078	672,70 €

ZA DODATNE MODELE STEPENICA VIDETI TABELU NA DNU ČLANKA ROLETNA PREKRIVKI
FOR FURTHER STAIRS MODELS, SEE TABLE AT THE BOTTOM OF THE SHUTTER COVERS CHAPTER

LAMELE / SLATS

Odgovaraju bazenima od 2 m do 10 m širine.

Profil lamela i izgled bez varenja i neravnina kapica čine roletnu plug look without welding or smearing makes the cover very aesthetics. estetski vrlo dopadljivom. Zahvaljujući svojim kavicama radijusnim u tri različite dimenzije, lamele su uklapaju u svaku konfiguraciju bazena.

Klizni sklop je patentirani sistem koji olakšava montažu i demontažu lamela. Ova montaža je moguća zahvaljujući uklonjivim čepovima.

Tretman protiv UV.

PVC opaque slats: suitable for pools from 2 m up to 10 m of width.

Suitable for pools from 2,5 m up to 6 m of width. The blade profile and the plug look without welding or smearing makes the cover very aesthetics. Thanks to its plugs of 3 different sizes and to the rayed ones, the slats adapt to each configuration of pool.

This assembly is possible thanks to the removable plugs. Anti-UV treatment.

Lamele PVCmat/PVCCopaqueslats



KARAKTERISTIKE LAMELE ESTRUDIRANE U PVC

- Širina 69 mm / Debljina 13 mm
- Bez aditiva olova sa formulom na bazi kalcijum cinka
- Otpornost na fleke nastale od organskih naslaga

EXTRUDED PVC SLATS FEATURES

- Width 69 mm / Thickness 13 mm
- Without lead additive with a zinc calcium-based formula
- Resistance to stains due to organic deposits

Solarne polikarbonat lamele/Solarpolycarbonateslats



KARAKTERISTIKE ESTRUDIRANIH LAMELA OD POLIKARBONATA

- Širina 69 mm / Debljina 13 mm
 - Ekstremna otpornost na udarce
 - Zaptivke realizovane unutar lamele
- Nekompatibilne za tretman bromom!!**

EXTRUDED POLYCARBONATE SLATS FEATURES

- Width 69 mm / Thickness 13 mm
 - Extreme resistance to shocks
 - Seal made inside the slat
- Incompatible with bromine treatments !!**

BOJE NA RASPOLAGANJU ZA PVC LAMELE PVC SLATS AVAILABLE COLOURS



bela white siva grey pesak sand Sv.plava light blue

BOJE NA RASPOLAGANJU ZA PVC LAMELE PVC SLATS AVAILABLE COLOURS

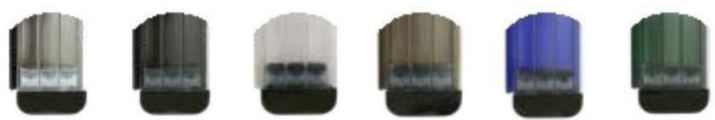

crystal/srebrna crystal/silver crystal/crna crystal/black crystal crystal crystal braon crystal brown crystal plava crystal blue crystal zelena crystal verde

opcije / options

KARAKTERISTIKE kapica

- Montane u produžetku lamela
- 3 dimenzije na raspolaganju: S (15 mm), standard (25 mm), XL (35 mm)
- Specijalne kapice za poliprečnike i stepenice.

PLUGS FEATURES

- Mounted in the continuity of the slat
- 3 sizes available: S (15mm), standard (25mm), XL (35mm)
- Special plugs for rays and roman stairs

3 DIMENZIJE NA RASPOLAGANJU / 3 AVAILABLE SIZES

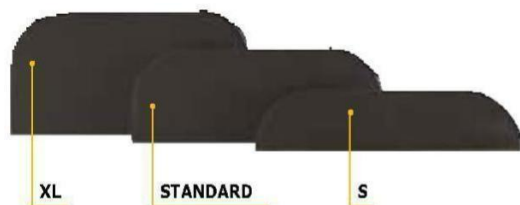

SPECIJALNE KAPE ZA POLUPREČNIKE I STEPENICE / SPECIAL PLUGS FOR RAYS AND ROMAN STAIRS



Radijus od 5 cm
Radius 5 cm

Radijus od 10 cm
Radius 10 cm

Radijus od 15 cm
Radius 15 cm

Radijus od 20 cm
Radius 20 cm

Kapice za oblikovanje radijusa stepenica
Special plug for the stairs radius

LAMELE / SLATS

šifra /code	2,00	2,50	3,00	3,50	4,00	4,50	5,00	6,00	7,00	8,00	9,00	10,00
LAMELE PVC MAT / PVC OPAQUE SLATS												
Lamele PVC bela mat White opaque PVC slats	5060562	5060572	5060008	5060298	5060009	5060010	5060011	5060013	5060014	5060015	5060126	5060132
Lamele PVC pesak mat Sand opaque PVC slats	5060563	5060573	5060016	5061117	5060017	5060018	5060019	5060021	5060022	5060023	5060127	5060137
Lamele PVC sivo mat Grey opaque PVC slats	5060564	5060574	5060024	5062225	5060025	5060026	5060027	5060029	5060030	5060031	5060128	5060142
Cena/price	249,30 €	257,70 €	264,20 €	314,70 €	347,80 €	387,20 €	437,60 €	509,50 €	564,00 €	633,10 €	698,50 €	786,50 €
Lamele PVC svetlo plava Light blue opaque PVC slats	5060565	5060575	5060032	5060033	5060582	5060034	5060035	5060037	5060038	5060039	5060129	5060149
Cena/price	258,00 €	269,60 €	276,60 €	411,30 €	415,40 €	442,30 €	480,90 €	532,30 €	602,70 €	674,10 €	801,80 €	969,70 €
LAMELE POLIKARBONAT SOLARNI / POLYCARBONATE SOLAR SLATS												
Lamele L84 PVC ili sivo mat mat / L84 PVC slats white or gray matte	5060585	5060586	5060587	5060588	5060589	5060590	5060591	-	-	-	-	-
Cena/price	205,30 €	225,20 €	237,90 €	283,20 €	313,00 €	348,50 €	393,90 €	-	-	-	-	-
Lamele polikarbonat solarni / Polycarbonate solar slats	5060566	5060576	5060046	5060583	5060047	5060584	5060049	5060051	5060143	5060144	5060148	5060146
Cena/price	698,60 €	790,50 €	878,20 €	966,70 €	1.074,10 €	1.283,20 €	1.350,80 €	1.632,20 €	1.898,80 €	2.175,40 €	2.443,90 €	2.822,30 €

Stepenice / stairs	Opcija stepenice /taglio					
	stepenice romana/roman stair		stepenice trapezoidna/trapezoidal		stepenice prave/straight	
	Ø step do 3m	Step od 3-4m fi	Baze do 3m	Baze od 3m do 4m	Baze do 1,50 m	Base da 1,50m a 2,50m
Lamele PVC bele mat white opaque PVC slats	5060076	5060082	5060086	5060090	5060094	5060106
Lamele PVC pesak mat sand opaque PVC slats	5060077	5060083	5060087	5060091	5060095	5060107
Lamele PVC mat sive grey opaque PVC slats	5060078	5060183	5060187	5060197	5060096	5060105
Cena/price	672,70 €	1.065,40 €	858,00 €	987,60 €	535,30 €	662,30 €
Lamele PVC sv.plavi Light blue opaque PVC slats	5060079	5060102	5060103	5060101	5060097	5060104
Cena/price	720,60 €	1.149,60 €	886,50 €	1.025,20 €	570,30 €	707,70 €
Lamele L84 PVC belo ili Sivo mat / L84 PVC slats white or gray matte	5060592	5060593	5060594	5060595	5060596	5060597
Cena/price	605,30 €	959,10 €	772,50 €	889,10 €	482,20 €	596,20 €
Lamele polikarbonat solarni / Polycarbonate solar slats	5060081	5060085	5060089	5060093	5060099	5060109
cena/price	1.763,60 €	2.272,20 €	1.621,00 €	2.184,20 €	1.130,00 €	1.691,40 €
Profilisanje lamele (po m)Shaping slats	5060112					
Cena/price	564,00 €					

PROFILNA VOĐICA LAMELE ZA PRELIVNE BAZENE / SLAT GUIDE FOR OVERFLOWING POOLS

šifra/code	opis/description	Cena/price
5061037	Profilna vodica lamele za prelivne bazene / Slat guide for overflowing pools (fino al 2021)	Po kom / a piece 188,00 €
5061039	Profilna vodica lamele za prelivne bazene pesak / Slat guide for overflowing pools sand	Po kom / a piece 188,00 €
5061040	Profilna vodica lamele za prelivne bazene crno / Slat guide for overflowing pools black	Po kom / a piece 188,00 €
5061041	Profilna vodica lamele za prelivne bazene plavo / Slat guide for overflowing pools blue	Po kom / a piece 188,00 €
5061042	Profilna vodica lamele za prelivne bazene sivo / Slat guide for overflowing pools grey	Po kom / a piece 188,00 €
5061043	Profilna vodica lamele za prelivne bazene belo / Slat guide for overflowing pools white	Po kom / a piece 188,00 €



KAKO KALKULISATI REZANJE LAMELE
HOW TO CALCULATE THE SLAT CUTTING

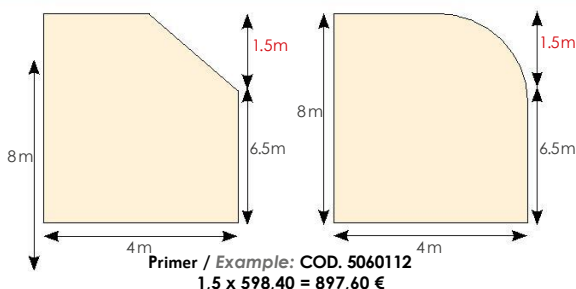

ZAHVALJUJUĆI ČEPOVIMA LUK STEPENICA ROMANA JE SAVRŠENO PROFILISAN
THE SPECIAL PLUG FITS PERFECTLY TO THE ROMAN SHAPE STAIRS



SAFETY COVER 4 GODIŠNJA DOBA / 4 SEASONS SAFETY COVER

PREKRIVKE 4 GODIŠNJA DOBA



PREKRIVKE / COVERS

Automatska sigurnosna prekrivka za nove ili postojeće

bazene Automatska prekrivka Safety Cover odgovara većini postojećih bazena ili novih u realizaciji a u skladu je sa sigurnosnim normama. Platno prekrivke realizovan je od poliester tkanine premazan PVC visoke otpornosti. Prekrivka se isporučuje kompletna sa platnom, ramom, električnim motoreduktorom, vođicama i potopnom pumpom.

Standardno platno:

- Težina 600 gr/mq
- Otpornost na toplotu + 70°C
- Otpornost na hladnoću - 30°C

Automatic safety cover for new or existing pools

The Safety Cover automatic cover fits most existing or newly built pools and complies with safety standards. Cover made of high-strength PVC-coated polyester fabric. The cover is supplied complete with cloth, panel, electric gearmotor, guides and submersible pump.

Standard cover:

- Weight 600 gr/sqm
- Heat resistance + 70 °C
- Cold resistance - 30 °C

PREDNOSTI KOD IZBORA PREKRIVKE 4 GODIŠNJA DOBA SAFETY COVER

The benefits of the 4 seasons safety cover

SIGURNOST I ZAŠTITA

safety and security

BAZEN ČIST I SPREMAN ZA UPOTREBU

pool clean and ready for use



OTPORNOST I TRAJNOST

strong and durable

IZOLACIJA

insulation



UŠTEDA

cost saving

SVESTRAN

versati

VOĐICE ZA PREKRIVKE SAFETY COVER / SAFETY COVER SLIDING GUIDES



Iznad ivična vođica
Over edge guide



Skrivena vođica
Hidden guide



Vođica ispod ivice
Under edge guide



5 061132 **Vođica iznad ivice od aluminijuma za Safety Cover/Guide above aluminum edge for Safety Cover**

po m 103,00 €

5 061131 **Skrivena vođica od aluminijuma za Safety Cover/Retractable aluminum guide for Safety Cover**

m 161,50 €

5 061189 **Set vođica za ispod spuštenih ivica od aluminijuma za Safety Cover/Aluminum lowered underboard**

m 69,50 €

INSTALACIJA SA VOĐICAMA IZNAD IVICE Installation with guides over the pool edge

INSTALACIJA SA VOĐICAMA ISPOD IVICE Installation with guides under the pool edge

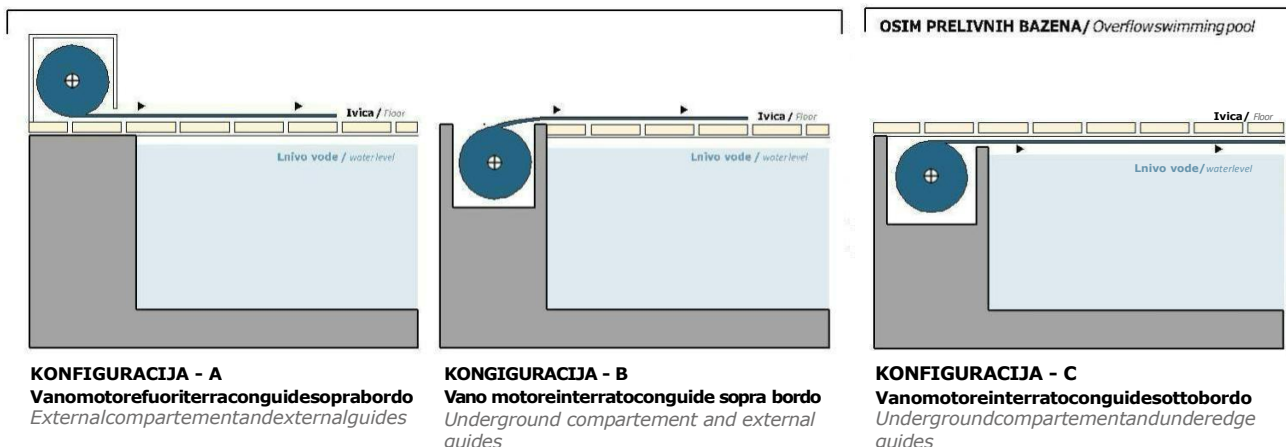

OSIM PRELIVNIH BAZENA / Overflows swimming pool

KONFIGURACIJA - A
Vanomotorefuoriterratconguidesoprabordo
External compartment and external guides

KONFIGURACIJA - B
Vano motoreinterratocongide sopra bordo
Underground compartment and external guides

KONFIGURACIJA - C
Vanomotoreinterratocongidesottobordo
Underground compartment and under edge guides

BOJE / COLOURS

BOJE STANDARDNO PLATNO na raspolaganju / STANDARD colours available in

plava
bluesv. plava
light bluebež
beigesivo
greytamno siva
dark greyzelena
green

Šifra /code	KONFIGURACIJA A : platno standard, tehnički prostor spoljni i spoljna vođica. Bez rešetke. CONFIGURATION A: standard cover, external technical housing, external guides. Duckboard excluded.	Cena/price
5 061141	Prekrivka Safety za bazen 8x4 m / Safetycover for pool 8x4	CENE NA
5 061142	Prekrivka Safety za bazen 9x4 m / Safetycover for pool 9x4	UPIT
5 061143	Prekrivka Safety za bazen 10x5 m / Safetycover for pool 10x5	
5 061144	Prekrivka Safety za bazen 11x5 m / Safetycover for pool 11x5	
5 061145	Prekrivka Safety za bazen 12x5 m / Safetycover for pool 12x5	
5 061440	Prekrivka Safety za bazen 12x6 m / Safetycover for pool 12x6	

Šifra /code	KONFIGURACIJA B : platno standard, tehničko kućište u zemlji i spoljna vođica. Bez rešetke. CONFIGURATION B: standard cover, underground technical housing, external guides. Duckboard excluded.	Cena/price
5 061146	Prekrivka Safety za bazen 8x4 m / Safetycover for pool 8x4	CENE NA
5 061147	Prekrivka Safety za bazen 9x4 m / Safetycover for pool 9x4	UPIT
5 061148	Prekrivka Safety za bazen 10x5 m / Safetycover for pool 10x5	
5 061149	Prekrivka Safety za bazen 11x5 m / Safetycover for pool 11x5	
5 061150	Prekrivka Safety za bazen 12x5 m / Safetycover for pool 12x5	
5 061441	Prekrivka Safety za bazen 12x6 m / Safetycover for pool 12x6	

Šifra /code	KONFIGURACIJA C : telo standard, vano tecnico interrato e guida sottobordo. Carabottino escluso. CONFIGURATION C: standard cover, underground technical housing, under edge guides. Duckboard excluded.	cena/price
5 061151	Prekrivka Safety za bazen 8x4 m / Safetycover for pool 8x4	14.751,00 €
5 061152	Prekrivka Safety za bazen 9x4 m / Safetycover for pool 9x4	14.973,00 €
5 061153	Prekrivka Safety za bazen 10x5 m / Safetycover for pool 10x5	15.927,00 €
5 061154	Prekrivka Safety za bazen 11x5 m / Safetycover for pool 11x5	16.202,00 €
5 061155	Prekrivka Safety za bazen 12x5 m / Safetycover for pool 12x5	16.481,00 €
5 061442	Prekrivka Safety za bazen 12x6 m / Safetycover for pool 12x6	17.121,00 €

INFORMACIJE I PERSONALIZOVANE PONUDE PO ZAHTEVU
INFORMATION AND CUSTOMIZED QUOTES ON REQUEST

CLASSIC B-1.1



Prekrivka sa šipkama CLASSIC B-1.1, leti kao i zimi, osigurava bazen održavajući temperaturu vode. Također vam omogućava da ograničite fenomen fotosinteze i širenje algi i drugih mikroorganizama. Pogodna za bazene 5x12 m + stepenice max 4x2 m, maksimalne dimenzije prekrivke 5,50x12,50 m (sa kutijom). Lako pozicioniranje sa samo 3 tačke zatezanja.

The cover bar CLASSIC B-1.1 in summer as in winter, secures the pool while preserving the water temperature. It also allows to limit the phenomenon of photosynthesis and the proliferation of algae or other micro organisms.

Suitable for pools up to 5x12 m + stair max 4x2 m, maximum dimensions cover 5.50x12.50 m. Easy positioning with only 3 tension points.

NARASPOLAGANJU U: / AVAILABLE IN

pesak sand	siva grey	antracite dark grey	maslina olive	zelena green	plava blue
---------------	--------------	------------------------	------------------	-----------------	---------------

KARAKTERISTIKE

1. TKANINA 580 g/m²

- Protiv-UV i fungicidni tretman
- Izuzetna stabilnost dimenzija
- Izvanredna otpornost na deformacije
- Rupe za odvod kišnice
- 25 cm prekrivke po celom obimu
- Finitura na sirovi rez
- U svim dezenima haličje tkanine je u boji peska

2. SISTEMI ZA KAČENJE

- Čegrtaljka inox i tipla inox i aluminijum
- Crni remeni

3. ELOKSIRANE ALUMINIJUMSKE ŠIPKE 20 MICRONS

- Čepovi šipki sive boje

4. NAMOTAVANJE / ODMOTAVANJE

- Uklonjivi remen za odmotavanje prekrivke na bazenu opremljena brzom spojnicom radi lakšeg kretanja.

- Prekrivka se isporučuje sa 1 ili 2 ručke(druga ručka se isporučuje polazeći od 50m²).

FEATURES

1. MATERIAL 580 g/m²

- Anti-UV and fungicidal treatment
- Exceptional dimensional stability
- Excellent resistance to deformation
- Holes for rainwater evacuation
- 25 cm of coverage on the perimeter
- Vivid cut finish
- In all colors, the back of the material is sand, except for the gray color which remains the same on both sides

2. HOOKING SYSTEMS

- 3 hooking belts with ratchet stainless and stainless steel dowel
- Black belts

3. BARS IN ANODIZED ALUMINUM 20 MICRONS

- Caps of the bars of gray color

4. WINDING AND UNWINDING

- Removable belt that allows the cover unwinding on the pool, equipped with a quick coupling to facilitate handling
- Cover delivered with 1 or 2 cranks (2nd crank delivered starting

from 50 m²)

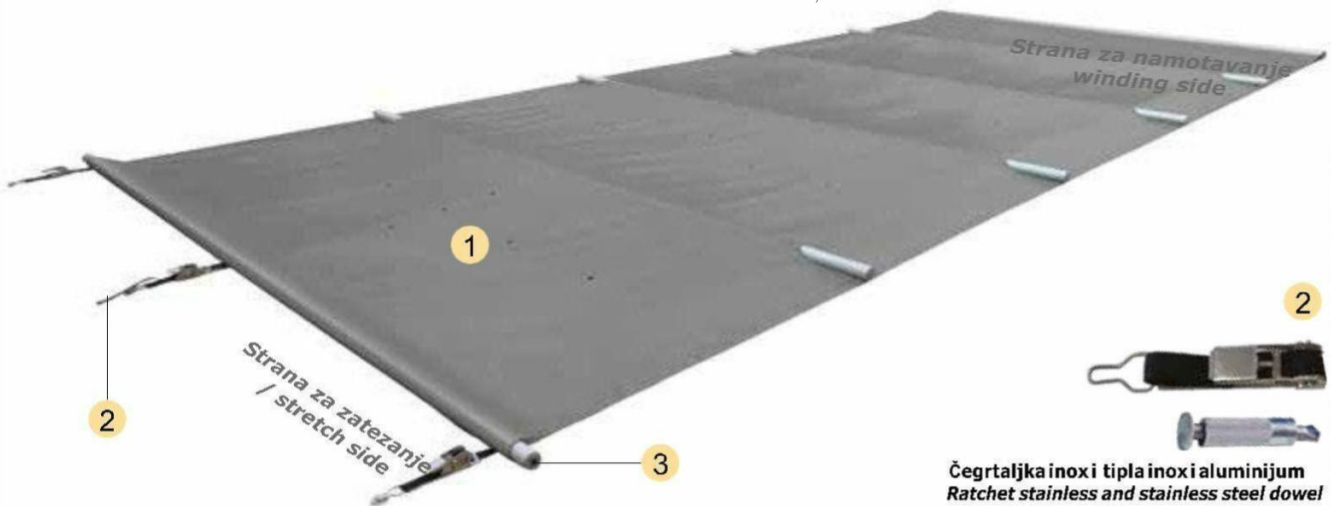

Čegrtaljka inox i tipla inox i aluminijum
Ratchet stainless and stainless steel dowel

1 060431	Prekrivka Classic B-1.1 pravougaoni oblik*/ Cover Classic B-1.1 rectangular shape*	al m2	69,90 €
1 060433	Presek stepenica po širini, max 4x2 m / Stair cutting on the width, max 4x2 m		445,10 €

* Ako je prekrivka < a 25 m² dodati 20% / If the cover is < than 25 m² plus-value of 20%

Šifra	Opis	Cena
1 060461	Prekrivka Classic B-1.1 za bazen 8x4 m — dimenzije prekrivke 8,50x4,50 m / Classic B-1.1 cover for pool 8x4	2.672,90 €
1 060462	Prekrivka Classic B-1.1 za bazen 9x4 m — dimenzije prekrivke 9,50x4,50 m / Classic B-1.1 cover for pool 9x4	2.987,40
1 060463	Prekrivka Classic B-1.1 za bazen 10x5 m — dimenzije prekrivke 10,50x5,50 m / Classic B-1.1 cover for pool 10x5	4.035,60 €
1 060464	Prekrivka Classic B-1.1 za bazen 11x5 m — dimenzije prekrivke 11,50x5,50 m / Classic B-1.1 cover for pool 11x5	4.419,90 €
1 060465	Prekrivka Classic B-1.1 za bazen 12x5 m — dimenzije prekrivke 12,50x5,50 m / Classic B-1.1 cover for pool 12x5	4.804,30 eur

PREMIUM B-2.1



KARAKTERISTIKE

1. TEKSTIL 580 g/m²

- Tretman protiv-UV i fungicida
- Izuzetna stabilnost dimenzija
- Izuzetna otpornost na deformacije
- Rubna krajnja obrada
- Rupe za odvod kišnice
- 25 cm prekrivke po celom obimu ili druge dimenzije po zahtevu
- Remeni na rubovima dužina za dodatnu sigurnost
- U svim bojama naličje tkanine je boje peska

2. SISTEMI ZA KAČENJE

- Čegrtaljka inox "easy" i tipla inox i aluminium
- Remeni su u harmoniji sa bojom prekrivke
- Ojačanje u PVC kristal ispod čegrtaljke radi zaštite ivice.

3. SISTEM PROTIV PODIZANJA

- 2 bočna remena sa čegrtaljkom inox "easy"
- Ojačanje u PVC kristal ispod čegrtaljki za zaštitu ivice
- Remeni u harmoniji sa bojom prekrivke

4. ELOKSIRANE ALUMINIJUMSKE ŠIPKE OD 20 MICRONA

- Čepovi šipki sive boje

5. NAMOTAVANJE / ODMOTAVANJE

- Uklonjivi remen za odmotavanje remena na bazenu,
- Opremljena brzom spojnicom radi lakšeg kretanja
- Prekrivka se isporučuje sa 1 ili 2 ručke (2^a ručka isporučena polazeći od 50 m²)

6. OPCIJA TRAKA PROTIV ABRAZIJE

- Trake tkanine protiv abrazije uklonjive ispod prekrivke

7. SKALA PO DUŽINI

- Zatezanje putem elastičnog sigurnosnog kabla- pesak

Prekrivka sa šipkama PREMIUM B-2.1, leti kao i zimi osigurava bazen održavajući temperaturu vode. Takođe omogućava umanjnjenje fenomena fotosinteze i širenje algii li drugih mikroorganizama. Pogodna za bazene do 5,50x12 m + stepenice max 4x2 m, dimenzije max prekrivke 6x12,50 m (ivice standard 25 cm ili druge mere po zahtevu, sa stepenicama). Održavanje prekrivke na ivicama bazena preko dva bočna zatezna remena. Remeni u harmoniji sa bojom prekrivke.

The cover bar PREMIUM B-2.1 in summer as in winter, secures the pool while preserving the water temperature. It also allows to limit the phenomenon of photosynthesis and the proliferation of algae or other micro organisms. Suitable for pools up to 5,50x12 m + stair max 4x2 m, maximum dimensions cover 6x12.50 m (standard bleeds 25 cm or other dimension on demand). Maintaining the cover on the edge pool through the two side tension belts.

NA RASPOLAGNJU / AVAILABLE IN



FEATURES

1. MATERIAL 580 g/m²

- Anti-UV and fungicidal treatment
- Exceptional dimensional stability
- Excellent resistance to deformation
- Finish with hem
- Holes for rainwater evacuation
- 25 cm of coverage on the perimeter or other dimension on demand
- Belts in the hems of the lengths for a reinforced security
- In all colors, the back of the material is sand, except for the gray color which remains the same on both sides

2. HOOKING SYSTEMS

- 3 hooking belts with ratchet stainless "easy" and stainless steel dowel
- Belts in harmony with the color of the cover
- PVC crystal reinforcement under the ratchets to protect the edges

3. ANTI UPRISING SYSTEM

- 2 side belts with ratchet stainless "easy"
- PVC crystal reinforcement under the ratchets to protect the edges
- Belts in harmony with the color of the cover

4. BARS IN ANODIZED ALUMINIUM 20 MICRONS

- Caps of the bars of gray color

5. WINDING AND UNWINDING

- Removable belt that allows the cover unwinding on the pool, equipped with a quick coupling to facilitate handling
- Cover delivered with 1 or 2 cranks (2nd crank delivered starting from 50 m²)

6. OPTION ANTI-ABRASION BAND

- Anti-abrasion cloth bands removable under the cover

7. STAIR LENGTH

- Tensioning by safety elastic cord

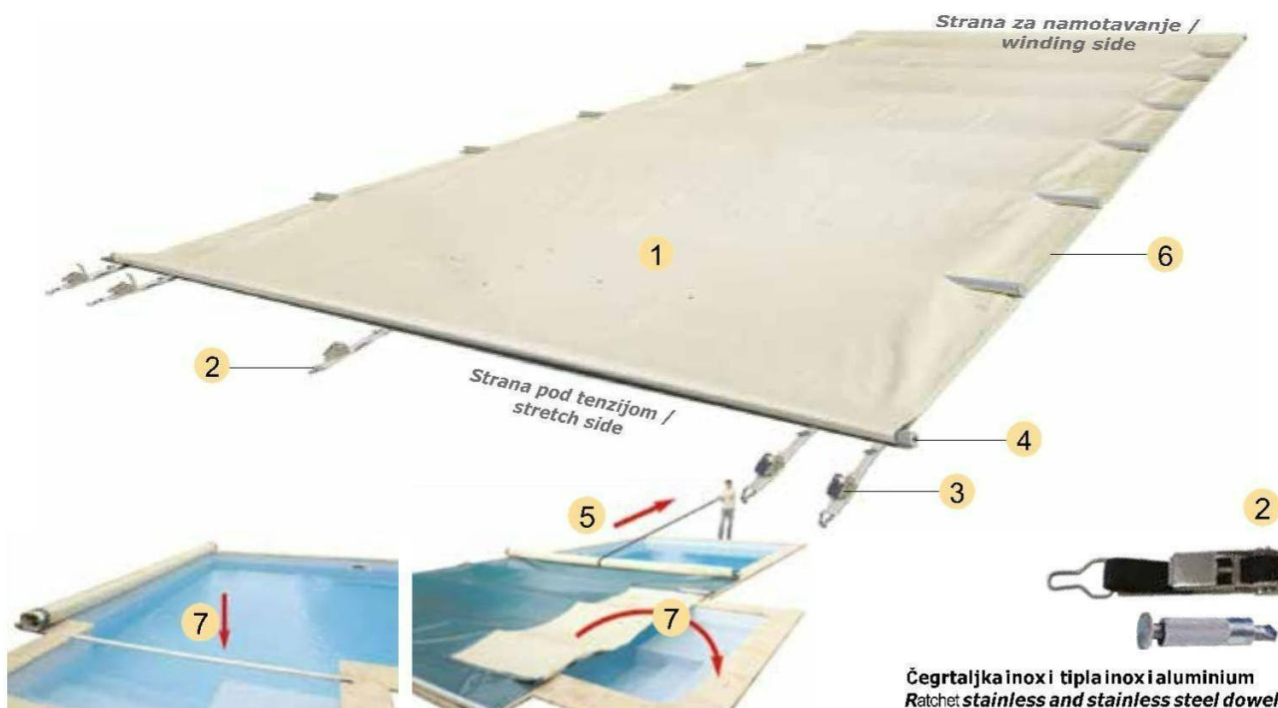

Čegrtaljka inox i tipla inox i aluminium
Ratchet stainless and stainless steel dowel

Šifra/code	Opis/description	po m2	Cena price
1060472	Prekrivka Premium B-2.1 pravougaoni oblik / Cover Premium B-2.1 rectangular shape*	po m2	86,40 €
1060473	Prekrivka Premium B-2.1 slobodni oblik / Cover Premium B-2.1 free shape	po m2	115,00 €
1060474	Presek stepenice po širini, max 4x2 m / Stair cutting on the width, max 4x2 m		460,90
1060475	Presek stepenice po dužini, massimo 4x2 m / Stair cutting on the length, max 4x2 m		728,70 €

* Ako je prekrivka \leq a 25 m² nadmerna 20% / If the cover is \leq than 25 m² plus-value of 20%

Šifra/code	Opis/description	Cena/price
1060466	Prekrivka Premium B-2.1 za bazen 8x4 m — dimenzije prekrivke 8,50x4,50 m / Premium B-2.1 cover for pool 8x4	3.304,00 €
1060467	Prekrivka Premium B-2.1 za bazen 9x4 m — dimenzije prekrivke 9,50x4,50 m / Premium B-2.1 cover for pool 9x4	3.692,60 €
1060468	Prekrivka Premium B-2.1 za bazen 10x5 m — dimenzije prekrivke 10,50x5,50 m / Premium B-2.1 cover for pool 10x5	4.988,30 €
1060469	Prekrivka Premium B-2.1 za bazen 11x5 m — dimenzije prekrivke 11,50x5,50 m / Premium B-2.1 cover for pool 11x5	5.463,40 €
1060470	Prekrivka Premium B-2.1 za bazen 12x5 m — dimenzije prekrivke 12,50x5,50 m / Premium B-2.1 cover for pool 12x5	5.938,40 €
1060471	Prekrivka Premium B-2.1 za bazen 12x5,50 m — dimenzije prekrivke 12,50x6 m / Premium B-2.1 cover for pool 12x5,50	6.478,30 €

OBLICI ZA B-1.1 E B-2.1 / B-1.1 AND B-2.1 SHAPES

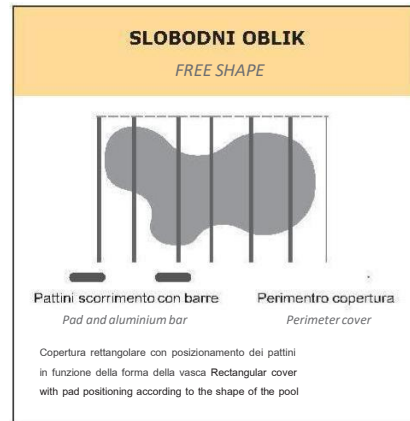
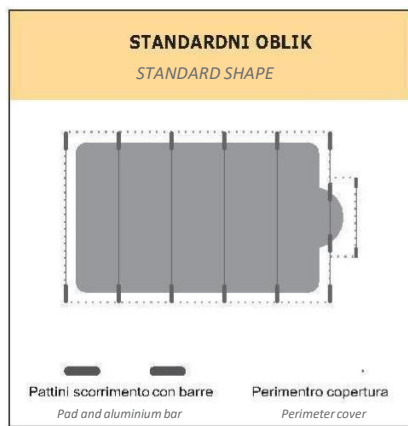

OPCIJE ZA PREKRIVKE B-1.1 E B-2.1 / B-1.1 AND B-2.1 COVERS OPTIONS

MOTALICA ROLL-E / ROLL-E WINDING

- Roll-e utroši 3 minuta da namota prekrivku sa šipkama za jedan bazen 10x5 m. Žičani daljinski upravljač omogućava pokretanje bez muke / Roll-e takes 3 minutes to wrap the bar cover for a 10x5 m pool. Its wired remote control allows it to be advanced without effort.
- Omogućava cca 10 namotavanja zahvaljujući ugrađenoj bateriji. Puni se iz električne mreže pomoću utikača postavljenog na upravljaču. Roll-e se pozicionira na kockasti otvor od 15 mm prekrivke sa šipkama / Allows about 10 windings thanks to its integrated battery. It recharges from the electrical mains using its jack plug located on the remote control. Roll-e fits onto the 15 mm square outlet of the bar cover.
- Raspolaže sa jednim adapterom za namotavanje na desno / Supplied with a right-hand winding adapter
- Kompatibilan sa prekrivkom dimenzija 5x12 m max (piscina da 4,50x11,50) / Compatible with a cover size of 5x12 mt maxi-mum (4,50x11,50 pool).



SET ZA SNEG / SNOWKIT

- Pozicioniran ispod prekrivke, omogućava da podnosi težinu snega na prekrivci. Positioned under the cover on the length, it allows to support the weight of the snow on the cover

SET ZA VETAR / WIND KJE

- Pozicioniran iznad prekrivke, omogućava da je drži prilipljenu na zemlju. Positioned over the cover, it allows to keep it bring down to the ground

CEVI ZA VODU / WATER TANKS

- Pozicionirani po ivicama prekrivke, dase koriste u slučaju jakih vetrova da bi ih oteretili balastom (u sadejstvu sa setom za vetar) / Positioned on the edge of the cover, to be used in case of very strong wind in order to ballast it

Šifra/code	Opis/description	Cena/price
1060476	Motalica ROLL-E / ROLL-E winding	2.253,80 €
1060438	Set za sneg / Snow kit	705,80 €
1060439	Set za vetar (vetar do 90 km/h) / Wind kit (wind at 90 km/h)	219,40 €
1060460	Bočni rezervoar con valvole per carico acqua rinforzato, larghezza 0,28 m, lunghezza 1,00 m — sabbia, grigio o blu/ Side tank with reinforced water filling valves, width 0.28 m - sand, grey or blue	13,00 €
1060019	Bočni rezervoar con valvole per carico acqua rinforzato, larghezza 0,28 m, lunghezza 1,00 m — verde / Side tank with reinforced water filling valves, width 0.28 m, length 1.00 m - green	13,00 €



Prekrivka sa šipkama Coverkit namenski je projektovana za ukopane bazene unutrašnjih dimenzija od 7x3 m do 9x4 m. Troškovi transporta su umanjeni i jednostavnost montaže je osigurana.

Korišćeni materijali za platno i finiture visokog su kvaliteta, garantujući prekrivki Coverkit izuzetnu otpornost. Zahvaljujući prekrivki sa šipkama Coverkit, bazen će biti zaštićen Preko cele godine i biće poprilično smanjeno isparavanje vode. Štedeći tako i strujui proizvode za tretman vode.

The Coverkit bar cover is specially designed for inground pools from 7x3 m to 9x4 m. Transportation costs are reduced and ease of installation is assured.

The materials used for the fabric and finish are of high quality, ensuring that the Coverkit cover is extremely durable. With the Coverkit bar cover, the pool will be protected year-round and water evaporation will be greatly reduced, also saving on electricity and water treatment products.

KARAKTERISTIKE

- TKANINA 580 g/m²**
 - Platno PVC izuzetno otporna armirana
 - Na raspolaganju samo u sivoj boji, naličje platna je boje peska
 - Tretman protiv-UV i gljivica
 - Izvanredna otpornost na deformacije
 - Finiširane ivice
 - Rupe za odvod kišnice
 - Kaiševi po dužnim ivicama radi pojačane sigurnosti
- SISTEMI KAČENJA**
 - Gedore inox "easy"
 - Kaiševi u skladu sa bojom prekrivke
- SISTEM PROTIV PODIZANJA**
 - Bočni kaiševi sa gedorama "easy"
 - Kaiševi u skludu sa bojom prekrivke
- ŠIPKE OD ELOKSIRANOG ALUMINJUMA 20 MICRONS - Ø45 mm**
 - Čepovi za finiširanje šipki
- NAMOTAVANJE / ODMOTAVANJE**
 - Pokretni kaiševi za odmotavanje prekrivke bazena
 - Prekrivka isporučena sa 1ručkom ili sa motalicom sa motorom Roll-e (pag. 393)
- OPCIJA TRAKA PROTIV HABANJA**
 - Tekstilne trake protiv habanja pokretne ispod prekrivke

FEATURES

- MATERIAL 580 g/m²**
 - Ultra-strong reinforced PVC sheet
 - Anti-UV and fungicidal treatment
 - Excellent resistance to deformation
 - Finish with hem
 - Holes for rainwater evacuation
 - Available in gray color, the reverse side of the sheet is sand color
- HOOKING SYSTEMS**
 - ratchet stainless "easy"
 - Belts in harmony with the color of the cover
- ANTI UPRISING SYSTEM**
 - 2 side belts with ratchet stainless "easy"
 - Belts in harmony with the color of the cover
- BAR IN ANODIZED ALUMINUM 20 MICRONS**
 - Finishing caps of the bar
- WINDING AND UNWINDING**
 - Removable belt that allows the cover unwinding on the pool, equipped with a quick coupling to facilitate handling
 - Cover delivered with 1 crank or Roll-e motorized winder (p. 393)
- OPTION ANTI-ABRASION BAND**
 - Anti-abrasion cloth bands removable under the cover

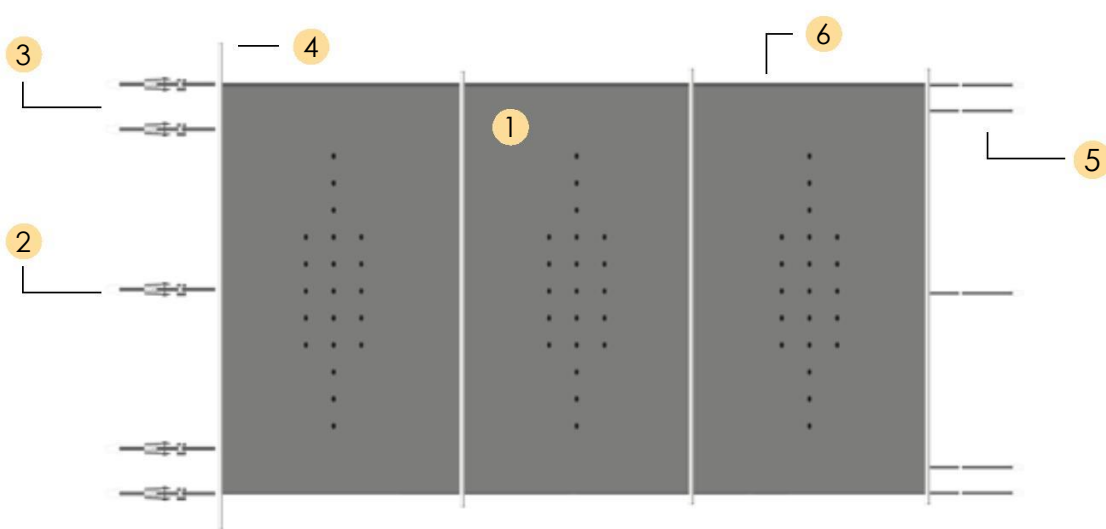

Šifra/code	Opis/description	Cena/price
1063191	Prekrivka Coverkit za bazen 7x3 m - dimenzije prekrivka 7,50x3,50 m	1.497,00 €
1063192	Prekrivka Coverkit za bazen 8x3 m - dimenzije prekrivka 8,50x3,50 m	1.762,00 €
1063193	Prekrivka Coverkit za bazen 9x3 m - dimenzije prekrivka 9,50x3,50 m	2.029,00 €
1063194	Prekrivka Coverkit za bazen 7x4 m - dimenzije prekrivka 7,50x4,50 m	1.890,00 €
1063195	Prekrivka Coverkit za bazen 8x4 m - dimenzije prekrivka 8,50x4,50 m	2.235,00 €
1063196	Prekrivka Coverkit za bazen 9x4 m - dimenzije prekrivka 9,50x4,50 m	2.580,00 €

ZIMSKA PREKRIVKA / WINTER COVER



Cerada prekrivke za zimsko zatvaranje bazena. Geomembrana sintetička od ojačanog polietilena, bova zeleno/crno, proizvedena sa premazom od polietilena niske gustine na obe strane ojačana unutrašnjom armaturom u tkanini od polietilena visoke gustine. **Na raspolaganju sa masom površine (masa tela/površine) od 210 g/m² ili od 240 g/m².** Cevni rezervoari realizovani sa hermetičkim ventilom i upakovani u ojačanu PVC tkaninu, otporan materijal za zadržavanje vode.

Cover made for the winter closing of pools. Synthetic polyethylene reinforced geomembrane green / black, produced by coating in low density polyethylene on both sides and reinforced with an internal reinforcement fabric of high density polyethylene. Available with mass per unit area (mass / body surface area) of 210 g/m² or 240 g/m². Tubular tanks made of valve-sealed and packed in PVC reinforced fabric, durable material to hold water.



1 060020	Cerada 210 pravougaoni oblik sa ušicama po obodu i elastičnom trakom Cover 210 rectangle with perimeter eyelets and elastic cord	al m ²	8,90 €
1 060070	Cerada 210 pravougaonog oblika sa uklonjivim trakama za rezervoare Cover 210 rectangular with ties to the removable tanks	al m ²	7,30 €
1 060071	Cerada 210 pravougaona sa stepenicama sa ušicama i po obodu i elastičnim kanapom Rectangular 210 cover with ladder with perimeter eyelets and elastic cord	al m ²	9,30 €
1 060072	Cerada 210 pravougaoni oblik sa stepenicama, sa trakama za uklonjive rezervoare Rectangular 210 cover with ladder with ties to the removable tanks	al m ²	8,90 €
1 060073	Cerada 210 slobodnog oblika sa ušicama po obodu i elastičnog kanapa Cover 210 free-shape with perimeter eyelets and elastic cord	al m ²	10,40 €
1 060074	Cerada 210 slobodnog oblika sa trakama za uklonjive rezervoare Cover 210 free-shape with ties to the removable tanks	al m ²	10,00 €
1 060200	Cerada 240 pravougaonog oblika sa ušicama po obodu i elastičnog kanapa Cover 240 rectangle with perimeter eyelets and elastic cord	al m ²	9,40 €
1 060201	Cerada 240 pravougaonog oblika sa trakama za uklonjive rezervoare Cover 240 rectangular with ties to the removable tanks	al m ²	7,80 €
1 060202	Cerada 240 rettangolare con scala con occhielli perimetrali e corda elastica Cover 240 with ladder with perimeter eyelets and elastic cord	al m ²	9,90 €
1 060203	Cerada 240 forma rettangolare con scala con fasce per serbatoi amovibili Cover rectangular 240 cover with ladder with ties to the removable tanks	al m ²	9,50 €
1 060204	Cerada 240 forma libera con occhielli perimetrali e corda elastica Cover 240 free-shape with perimeter eyelets and elastic cord	al m ²	11,00 €
1 060205	Cerada 240 slobodnog oblika sa trakama sa uklonjivim rezervoarima Cover 240 free-shape with ties to the removable tanks	al m ²	10,60 €
1 060019	Bočni ojačani rezervoar sa ventilima za nosivost vode do m 1.00 Tank side with valves for water load reinforced up to 1.00	al pz	13,00 €
1 060018	Bočni ojačani rezervoar sa ventilima za nosivost vode do m 1.50 Tank side with valves for water load reinforced up to 1.50	al pz	19,50 €
1 060022	Bočni ojačani rezervoar sa ventilima za nosivost vode do m 2.00 Tank side with valves for water load reinforced up to 2.00	al pz	26,00 €
1 060024	Bočni ojačani rezervoar sa ventilima za nosivost vode do m 3.00 Tank side with valves for water load reinforced up to 3.00	al pz	39,00 €
1 060025	Vazdušne cevi za centralni oslonac cerade sa kanapom za fiksiranje Tubular air for central support of the cover including fixing rope - to m	al m	51,10 €

ZIMSKA PREKRIVKA PVC / WINTER COVER PVC



Cerada za prekrivku za zimsko zatvaranje bazena. Geomembrana sintetička poliester tkanini premazano PVC, tretirana ultravioletnim zracima protiv hlora, gljivica i buđi. **Na raspolaganju T400 (400g/m²) ili T600 (600g/m²)** DVOBOJNO boje zeleno/crno. Rezervoari realizovani sa hermetičkim ventilom i upakovani u ojačani PVC otporni materijal otporan da bi podneo vodu.

Cover tarp for the winter closing of the swimming pools. Synthetic geomembrane in polyester fabric coated with PVC, anti-tear treated with ultraviolet and chlorine fungi and mold. Available in T400 (400g/m²) or T600 (600g/m²) BICOLOR green/black. Tanks made with hermetic valve and packed in reinforced PVC fabric, resistant material to contain water.



Šifra/code	Opis/description		Cenaprice
1 060307	Cerada 400 in PVC sa ušicama na obodima i elastičnom sajlom 4 00PVC cover rectangle w/perimeter eyelets and elastic cord	al m ²	16,80 €
1 060304	Cerada 400 PVC pravougaonog oblika sa trakama za uklonjive rezervoare 400 PVC rectangular cover w/ties to the removable tanks	al m ²	14,40 €
1 060305	Cerada 400 in PVC pravougaonog oblika sa stepenicama sa trakama za uklonjive rezervoare 400 cover with ladder with ties to the removable tanks	al m ²	17,30 €
1 060308	Cerada 400 od PVC pravougaonog oblika sa stepenicama sa ušicama oboda i elastik sajla 400 cover with ladder with perimeter eyelets and elastic cord	al m ²	17,30 €
1 060309	Cerada 400 PVC slobodnog oblika sa ušicama na obodima i elastičnom sajlom 400 PVC free-shape w/rimeter eyelets and elastic cord	al m ²	18,30 €
1 060306	Cerada 400 PVC slobodnog oblika sa trakama za uklonjive rezervoare 400 PVC cover free-shape with ties to the removable tanks	al m ²	18,50 €
1 060300	Cerada 600 in PVC pravougaoni oblik sa ušicama na obodu i elastičnom sajlom 600PVC coverrectangle w/perimeter eyelets and elastic cord	al m ²	30,30 €
1 060301	Cerada 600 PVC Pravougaoni oblik sa trakama za uklonjive rezervoare 600 PVC rectangular w/ties to the removable tanks	al m ²	29,00 €
1 060302	Cerada 600 PVC slobodnog oblika sa ušicama na obodu i elastičnom sajlom 600 PVC free-shape w/rimeter eyelets and elastic cord	al m ²	32,30 €
1 060303	Cerada 600 PVC slobodnog oblika sa trakama za uklonjive rezervoare / m2 600 PVC cover free-shape with ties to the removable tanks-m2	al m ²	31,20 €
1 060019	Bočni rezervoar sa ventilom za punjenje vodom ojačan do m 1.00 Tank side with valves for water load reinforced up to 1.00	al pz	13,00 €
1 060018	Bočni rezervoar sa ventilima za punjenje vodom ojačan do m 1.50 Tank side with valves for water load reinforced up to 1.50	al pz	19,50 €
1 060022	Bočni ojačani rezervoar sa ventilima za punjenje vodom do m 2.00 Tank side with valves for water load reinforced up to 2.	al pz	26,00 €
1 060024	Bočni ojačani rezervoar sa ventilima za punjenje vodom m 3.00 Tank side with valves for water load reinforced up to 3.00 m	al pz	30,00 €

ECOMREŽA ELTEX / ECONET ELTEX

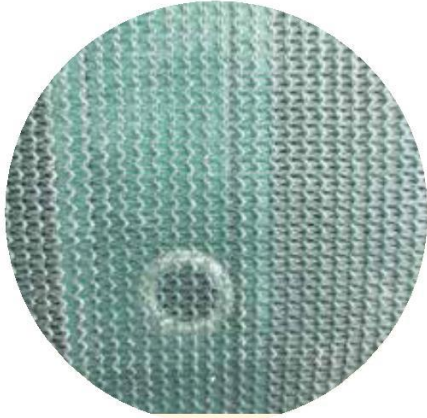

Mrežasta drenažna cerada za prekrivku bazena protiv prljavštine i sunca. Platno od polietilena visoke gustine (HDPE). Fiksiranje sa ušicama i kanapom.

Cloth drainage pool coverage for dirt and sun. Fabric of high density polyethylene (HDPE). Fixing with eyelets and rope.

KARAKTERISTIKE	Valori
Vazдушna masa (masa tela / površina)	160 g/m ²
Zatezna čvrstoća osnove	146 Kg
Zatezna čvrstoća teksture	100 Kg
Otpornost na bušenje	44 Kg
Otpornost na habanje	95% sačuvani otpor
Otpornost na UV (trajnost)	3000 h
Boja	zeleno/crno

Gore izneseni tehnički podaci prosleđeni po laboratorijskim nalazima, sa tolerancijom 10%

Šifra/code	Opis/description	Cena/price
1060021	Mrežasto platno zeleno Eltex pravougaoni oblik sa ušicama i elastičnim užetom-po m2 Eltex mesh green rectangular canvas with eyelets and elastic cord -to m2	15,30 €
1060075	Mrežasto platno zeleno Eltex slobodni oblik sa ušicama i elastičnim užetom-po m2 Eltex mesh green free shape with ladder and eyelets and elastic cord -to m2	18,50 €

OPREMA I PREKRIVKE / COVERS ACCESSORIES

Šifra /code	Opis /description	Cena/price
1060089	Komplet tiplova inox 6mm krstasti, 10kom / Stainless steel dowel set 6mm with cross, 10pcs	39,20 €
1060079	Opruga zimske prekrivke (sa zaštitom), 10kom / defrost cover spring set (with protection), 10pcs	117,90 €
1060049	Skriveni tipl Ø 20 mm od mesinga / Brass Notch to the disappearance of 20 mm diameter	4,80 €
1060040	Zaštita PVC per za oprugu prekrivke / PVC protection for spring cover	2,30 €
1060041	Koćić za travu, od PVC da 30 cm / Picket for grass, PVC 30 cm	6,90 €
1060043	Elastično kablo 8 mm bež-po m / 8 mm beige elastic cord-m	1,50 €
1060044	Graničnik elastičnog kabla / Stopping of the elastic cord	1,00 €
1060045	Dvostruka šelna / Double Cabclic	5,80 €
1060046	Elastično kablo FIXKIT za završnu obradu perifernih spojeva/ FIXKIT elastic cable for peripheral joint finishing	106,80 €
1060047	Tipla Ø 6 mm inox /aluminijum / Dowel diameter 6 mm steel / aluminum	1,90 €
1060048	Tipla Ø 8 mm inox /aluminijum / Dowel diameter 8 mm steel / aluminum	3,00 €



cod.1060089



cod.1060045



cod.1060049



cod.1060040



cod.1060041



cod.1060043



cod.1060044



cod.1060046



cod.1060047

ANTIFRIZ PLOVCI / ANTIFREEZE FLOATERS



- Materijal: PE HD nero
- Težina: 0,50 m 2730 gr
- Balast: prosušeni pesak granulaža od 1 a 2 mm
- Fiksni čep
- Montaža plovaka sa sigurnosnom kukom

- Material: PE HD black
- Weight: 2730 g at 0.50 m
- Ballast: dried sand particle size from 1 to 2 mm
- Not removable stopper
- Assembly of the float with safety latches

Šifra /code	Opis /description	Cena/price
1060055	Antifriz plovak da 0,50 m, balansni / Floater of 0.50 m, ballasted	26,50 €
1060058	Gizmo, antifriz za skimer, sa navojem 1 1/2 e 2" / Gizmo, antifreeze skimmer, threaded 1 1/2 and 2"	12,20 €

ZIMSKA KAPA / DEFROST CAP



Od kaučuka, sa koničnim oblikom i leptir šrafof. in rubber, with a conical shape and wing nut.

Šifra	Opis /description	Cena/price
1060060	Gumena zimska kapa 1 ¹ / ₄ N°9 (Ø45 mm) / Defrost rubber plugs 1 ¹ / ₄ N° 9 (Ø45 mm)	8,90 €
1060061	Gumena zimska kapa 1 ¹ / ₂ N°10 (Ø50 mm) / Defrost rubber plugs 1 ¹ / ₂ N°10 (Ø50 mm)	9,60 €
1060062	Gumena zimska kapa 1 ³ / ₄ N°11 (Ø55 mm) / Defrost rubber plugs 1 ³ / ₄ N°11 (Ø55 mm)	13,40 €
10		15,30 €
60063 1070091	Gumena zimska kapa 2 ¹ / ₂ N°12 (Ø63 mm) / Defrost rubber plugs 2 ¹ / ₂ N°12 (Ø63 mm) Gumena zimska kapa sa navojem 1 ¹ / ₂ sa prstenastom prirubnicom/ Defrost rubber plugs 1 ¹ / ₂	14,00 €

POTOPNE PUMPE ZA PREKRIVKE / SUBMERSIBLE PUMPS FOR COVERS



Potopna pumpa se koristi za automatsko pražnjenje cerade zimske prekrivke. Savršena takođe na neravnim površinama za uklanjanje viška akumulirane vode. Kucište, izrađeno od izdržljivog polimernog materijala, pruža zaštitni štiti za motor. La baza je dizajnirana za povećanje stabilnosti.

The submersible pump is used for automatic emptying of the winter cover sheet. Also perfect on uneven surfaces to remove excess accumulated water.

The pump housing, constructed of durable polymer material, provides a protective shield for the motor. The base is designed to increase stability.

Šifra/code	Opis/description	Cena/price
1060069	Pumpa za pražnjenje prekrivke Cover emptying pump	151,00 €



Potpuno automatska potopna pumpa zahvaljujući integrisanom plovku. Široka noseća baza oslonca koji jamči stabilnost i mogućnost funkcionisanja čak i u pozicijama koja nisu potpuno vertikalna sa zemljištem. Pogodna za korišćenje u zimskom periodu na prekrivkama za skidanje kišnice. u slučaju potrebe postaje potopna pumpa za pražnjenje. Strujni napon 230 V-50 Hz mono, prolazna granulometraža 5 mm, stepen zaštite motora IP 68, dužina kabla 10 m.

Submersible pump totally automatic thanks to the integrated float. Wide support base that guarantees stability and possibility to work also in positions not exactly perpendicular to the ground. Suitable to be used during the winter period on the covers to remove rainwater. In case of necessity becomes emptying submersible pump. Power supply 230 V-50 Hz mono, passage granulometry 5 mm, motor protection IP 68, cable length 10 m.

Šifra /code	Opis /description	Cena/price
1060068	Pumpa za pražnjenje cerade EUROCOVER Cover emptying pump EUROCOVER	364,80 €



Opremljena elektronskom pločom i niskonaponskim sigurnosnim motorom. Opremljena u kompletu sa transformatorom od 60VA in 12V per za spoljnu upotrebu. Voda koja se akumulira na ceradi automatski se izbacuje putem kontrolnog senzora dobijenog od dve čelične lamele inox koje kada dodju u dodir sa vodom, odmah aktiviraju pumpu. Pumpa se automatski gasi. Posедуje široku bazu kao oslonac koja garantuje stabilnost i jedan porozni sunđer da ne bi došlo do zagušenja kod kola hidraulike.

It is equipped with an electronic board and a motor at low safety voltage. It is supplied with a transformer 60VA for 12V for external use. The water that accumulates above the towel is automatically evacuated through the control of a sensor obtained by stainless steel reeds which, once in contact with water, immediately activate pump. The pump shuts off automatically. . . A wide base of support that ensures stability and a sponge porosity in order to prevent clogging of the hydraulic circuits.

two
the

Šifra/code	Opis/description	Cena/price
1 060066	Potopna pumpa za prekrivke Submersible pump for covers	194,80 €



Motorna potopna pumpa sastoji se iz tri dela : pumpa, mehaničko zaptivanje i motor. Pumpa se nalazi u donjem delu motora, sa centrifugalnim impelerom. Unutrašnja zaštita sprečava oštećenje pumpe prouzrokovane neuobičajenom snagom, blokade i preopterećenja. Telo pumpe od aluminijuma, izolaciona klasa : B/F, zaštita IP68

The submersible motor pump consists of three parts : pump, mechanical seal and motor. The pump is located in the lower part of the motor, with a centrifugal impeller. Internal protection prevents to the pump damage due to abnormal power, blocks and overload. Aluminum pump body, insulation class : B F, IP68 protection.

Šifra/code	Opis/description	Cena/price
1 090036	Potopljena pumpa 230 V mono, 0,55 kW sa 6 m dikabla bez čepa/ Submersible pump 230 V mono, 0.55 kW with cable 6 m without plug	198,00 €

LETNJA PREKRIVKA SA MEHURIĆIMA / SUMMER COVER WITH BUBBLES



Izotermička cerada na vazdušnim mehurićima 400 mikrona u dvoslojnom listu niske gustine, stabilizovan na UV zrake, obrubljen po obodu sv.plavom PE. Za instalirati na površini vode bazena. Uvećanje za cerade sa metražom nižom od 25 m²: + 10%. Uvećanje za cerade krojene po nacrtu: + 20%.

Isothermal cover to air bubbles 400 microns in double sheet of soft low density polyethylene, UV stabilized, PE blue edging strip. Installed on the water of swimming pools. Increase for sheets with size less than 25 m²:+ 10%. Increase for shaped sheets of drawing: + 20%

Karakteristike	Vredn
Vazдушna masa (masa tela/ superficije)	350 g/m ²
Gravimetrijska debljina	400 u
Otpornost na cepanje	> 100 N/mm ²
Boje	Plavo - pesak - providno - crno

Gore navedeni tehnički podaci su izvedeni po laboratorijskim testovima, sa tolerancijom 10%

Šifra/code	Opis/description	Cena/price
1060030	Izotermička cerada sa vazdušnim mehurićima pravougaona sa štepom / m ² / rectangularisothermalcoverairbubble-tom ²	17,00 €
1060138	Izotermička cerada sa vazdušnim mehurićima skrojena sa štepom-al m ² / free shape isothermal cover air bubble - to m ²	20,80 €
1060032	Plutajuće cevi / m / Flotation tube- to m	25,80 €

LETNJA PREKRIVKA SA MEHURIĆIMA ULTRA LAKA / ULTRA LIGHT SUMMER COVER WITH BUBBLES



Prekrivka standard od polietilena, tretiran protivUV, sv.plava boja, debljina 400 μ. Mehurići prečnika 10 mm.

Standard cover polyethylene, anti UV treated, blue, thickness 400 μ. 10 mm diameter bubbles.

Šifra/code	Opis/description	Cena/price
1060050	Pravougaona izotermička prekrivka sa mehurićima7x3 m / rectangular isothermal cover bubble 7x3 m	287,00 €
1060052	Pravougaona izotermička prekrivka sa mehurićima 8x4 m/ectangular isothermal cover bubble 8x4	433,60 €
1060051	Pravougaona izotermička prekrivka sa mehurićima 9x4/ rectangular isothermal cover bubble 9x4 m	489,30 €
1060064	Pravougaona izotermičkaprekrivka sa mehurićima 10x4 m / rectangular isothermal cover bubble 10x4	544,00 €
1060053	Pravougaona izotermička prekrivka sa mehurićima 10x5 m / rectangular isothermal cover bubble 10x5	591,20 €

LETNJA PREKRIVKA MOUSSE / MOUSSE SUMMER COVER



Cerada mousse zatvorene ćelije od 100% polietilena debljine 6 mm, geosintetičko, nepromočivo i izolaciono. Pogodna za grejane bazene sa velikom energetskom uštedom. Uvećanje za cerade za cerade sa metražom manjom od 25 m²: + 10%. Uvećanje za cerade krojene po nacrtu: + 20%

Sheet with 100% closed cell foam polyethylene thickness 6 mm, geosynthetic, waterproof and insulating. Suitable for heated pools with significant energy savings.

Increase for sheets with size less than 25 m²:+ 10%. Increase for shaped sheets of drawing: + 20%

Caratteristiche	Valori
Vazдушna masa (masa tela/površina)	350 g/m ²
zatezna čvrstoća osnove	850 N/5cm
zatezna otpornost Teksture	850 N/5cm
Toplotna provodljivost a 10° C	0,038 W/mK
Conduttività termica a 40° C	0,042 W/mK
Apsorpcija vode (7dana)	<1vol.%

Gore navedeni tehnički podaci su izvedeni po laboratorijskim testovima, sa tolerancijom od 10%

Šifra/code	Opis/description	Cena/price
1060031	Cerada mousse zatvorene ćelije 6 mm pravougaoni oblik-po m ² / Closed cell foam sheet with 6 mm rectan- gular shape - m ²	35,20 €
1060139	Cerada mousse zatvorene ćelije 6 mm profilisani oblik-po m ² / Closed cell foam sheet with 6 mm free shape - m ²	42,60 €
1060032	Plutajuće cevi-po m/ Flotation tube-to m	25,80 €

OMEGA



Nogari oblikad'OMEGA, u cevi od eloksiranog aluminijuma Ø 40 mm, na glavčini dve prirubnice od sintetičke smole ojačana staklenim vlaknima sa integrisanim ležajevima. Jedan fiksni nogar, jedan mobilni nogar opremljen sa dva točka Ø 170 mm. Uređaj za zaključavanje osovine. Visina osovine 360 mm, prečnik osovine 95 mm. Isporučen sa 13 elastičnih sajli.

Feet in the shape of OMEGA, anodized aluminum tube Ø 40 mm, two flanges of synthetic resin reinforced with glass fibers with integral bearings. A fixed foot, a cabinet foot equipped with two wheels Ø 170 mm. Locking device of the axis. Height of 360 mm, shaft diameter 95 mm. Delivered with 13 elastic cables.

Šifra /code	Opis /description	Cena/price
1060000	Motalica Omega za bazen do 4 m širine/ Omega reel for pools up to 4 m wide	1.248,60 €
1060001	Motalica Omega za bazen do 5 m širine/ Omega reel for pools up to 5 m wide	1.330,90 €
1060002	Motalica Omega za bazen do 6 m širine/ Omega reel for pools up to 6 m wide	1.401,40 €
1060008	Motalica Omega za bazen do 7,50 m di širine*/ Omega reel for pools up to 7,50 m wide*	1.646,40 €

* Koncipiran za maksimalnu dužinu od 12 m / *Designed for a maximum length of 12 m

VELA



Vajlak od eloksiranog aluminijuma, prečnika 10 cm, podloške od čelika inox 304. Jedan nogar fiksni jedan mobilan, sa dva točka.

Anodized aluminum roller, diameter 10 cm, 304 stainless steel supports. A fixed foot, a cabinet foot equipped with two wheels.

Šifra/code	Opis/description	Cena/price
1 060110	Motalica Vela za bazen do 6 m širine / Vela reel for pool up to 6 m wide	740,40 €

ARIONE E REEL / ARIONE AND REEL

ARIONE: Valjak od eloksiranog aluminijuma, prečnik 14 cm, nosači od čelika inox 304 kompletni sa glavom u materijalu derlin bele boje za pričvršćivanje na aluminijumske i gvozdene ceviin acciaio inox za zaključavanje radilice. Ručica prekrivena crnom plastikom, nogari presvučeni u beloj plastici i točkovi presvučeni crnom gumom. Dužina prekrivke do 25 mt.

U opciji motorizacija, uključuje motor CC 24 V, selektor komande, električnu kutiju, kablo 6 metara.

ARIONE: anodized aluminum roller, diameter 14, 304 stainless steel supports full of white Derlin material head for fixing the aluminum tubes and stainless steel to lock the crank. Crank coated in black plastic, feet covered with white plastic and wheels coated in black rubber. Cover length up to 25 mt.

Motorization optional, includes motor CC 24 V, control selector switch, electrical panel, cable 6 meters.



Šifra/ code	Cod. 1060012 - Arione	Cod. 8020108 - Reel	Cod. 1060011 - Reel	Cena/ price
	Opis/description			
1060028	Motalica Arione uklonjiva da 4,30 a 5,50 m* / Arione removable reel from 4,30 to 5,50 m*			2.664,00 €
1060029	Motalica Arione uklonjiva da 5,00 a 6,50 m* / Arione removable reel from 5,00 to 6,50 m*			2.495,00 €
1060012	Motalica Arione uklonjiva da 6,50 a 7,50 m* / Arione removable reel from 6,50 to 7,50 m*			3.050,00 €
1060015	Motorizacija / Motorization			3.640,00 €
1060016	Prijemnik i daljinski upravljač / Receiver and remote control			1.980,00 €
1060011	Motalica Reel uklonjiva in alluminio 3x2,10 m / mobile aluminum reel 3x2,10 m			460,00 €
8020110	Motalica Reel in alluminio sa ramom ABS za nadzemni bazen, 3x2,10 m Aluminium Reel with ABS frame for above ground pool, 3x2,10 m			250,00 €
8020108	Motalica Reel in alluminio sa ramom ABS za cevasti bazen Aluminium Reel with ABS frame for tublar above ground pool			267,00 €

* Koncipiran za maksimalnu dužinu od 25 m / * Designed for a maximum length of 25 m



Dosing pump

DOZIRNE

PUMPE



9



Indice

DOZIRNE PUMPE

- 406 REGULISANJE TEČNOG HLORA REDOX / REGULATION OF LIQUID CHLORINE REDOX
- 406 REGULISANJE KISELINE PH / PH ACID REGULATION
- 407 ELEKTROMAGNETNA PUMPA PH / ELECTROMAGNETIC PH PUMP
- 407 ELEKTROMAGNETNA PUMPA REDOX / ELECTROMAGNETIC PUMP REDOX
- 407 REGULACIJA KISEONIKA / OXYGEN REGULATION
- 408 ALGICID I FLOKULANT / ALGICID AND FLOCCULANT
- 408 ESENCIJE / ESSENCES
- 408 ESENCIJE NISKOG PRITISKA / ESSENCE LOW PRESSURE
- 409 DEHLO-R-APID: SET ZA LA DEHLORACIJU I TRETMAN VODA
DECLO-R-APID: DECHLORINATION AND WATER TREATMENT KIT
- 409 DEHLORACIJA/DEZINFEKCIJA ZA KADU ZA PRANJE NOGU / DECHLORINATION-DISINFECTION
FOR FOOT-WASHING BASINS

PANELI ZA DOZIRANJE / DOSING PANELS

- 410 SIMPLY POOL PH I KISEONIK / SIMPLY POOL PH AND OXYGEN
- 410 SIMPLY POOL PH I HLOR / SIMPLY POOL PH AND CHLORINE
- 411 EASY POOL SLOBODNI HLOR-PH / EASY POOL FREE CHLORE-PH
- 411 SUPERIOR POOL SLOBODNI HLOR-PH / SUPERIOR POOL FREE CHLORE-PH
- 412 NEW SUPERIOR POOL SLOBODNI HLOR - PH - FLOCCULANTE / NEW SUPERIOR POOL FREE
CHLORE - PH - FLOCCULANT
- 412 MONTIRANI PANEL MOD WPHRH / ASSEMBLED PANEL MOD WPHRH

ELEKTROLIZA I DOZIRANJE PH

- 413 DOZATORI TABLETE HLORA I BROMA / TABLETS DOSING CHLORINE AND BROMINE
- 413 KONTEJNERI ZA ODLAGANJE / STORAGE TANKS
- 413 UREĐAJI ZA VELIKE AKVAPARKOVE/ EQUIPMENTS FOR BIG AQUATIC PARKS

OPREMA ZA DOZIRNE PUMPE

- 414 OPREMA ZA PUMPE SERIE DOS-CHEMICAL/ ACCESSORIES FOR PUMPS DOS-CHEMICAL
- 415 OPREMA ZA PUMPE / PUMP ACCESSORIES

PUMPA ZA DOZIRANJE KISELINE PH PODEŠAVANJE
PUMP ACID DOSAGE PH REGULATION

SERIJE DOS-CHEMICAL



- Pumpa peristaltička digitalna, sa integrisanim pH kontrolorom
- Vizualizacija vrednosti pH u realnom vremenu
- Pojednostavljeno programiranje setpointa u intervalu obuhvaćenom između 7,2 i 7,4. Kalibracija poluautomatska na samo jednoj vrednosti pH 7,00. Proporcijalno doziranje definitivnom set-pointu.
- Telo za pumpanje za ručnim odzračivačem
- Zaštita IP55 Isporučena u kompletu sa inekcionim ventilom 1/2", usisnim filterom PP usisnim ventilom, elektrodom pH kablom od 3 m, tampon rastvorom, dva držača fi 50 nosača cevi
- Odgovarajuća za bazene do 120 m³.
- *Digital peristaltic pump with integrated controller pH*
- *pH display in real time*
- *Set point easy programming in a range between 7,2 and 7,4. Semi-automatic calibration on an only pH value 7,00*
- *Dose proportional to the set point defined. Pumping body with manual drain*
- *Protection IP55 Supplied complete with injection valve 1/2", suction filter PP, pH Electrode with 3 m cable, buffer solution, 2 sockets to clamp Ø 50, support for the pipe*
- *Suitable for pools up to 120 mc*

Šifra / code	Opis /description	Cena/ price
1075170	Peristaltična dozirna pumpa pHPR 1 sim Peristaltic dosing pump pH PR 1 sim	346,00 €

PUMPA ZA DOZIRANJE KISELINE PH PODEŠAVANJE
PUMP ACID DOSAGE PH REGULATION

SERIE DOS-CHEMICA



- Peristaltička digitalna pumpa, proporcionalna sa ugrađenim pH instrumentom
- Definicija ranga proporcionalnosti.
- Proporcionalnost pumpe sa vremenskim intervalom/rada, max 300 sekunde
- Vizualizacija pH na display sa 3 cifre, 7 segmenta Ranga čitanja Ph od 0 do 14
- Pokazatelj efikasnosti sonde. Raspon veličine proporcionalnosti predviđen za vrednost 1pH
- Sposobna da dozira proizvode pH + e pH - (kiselina i baza) po softwaru
- Kalibracija polu-automatske sonde. Kutija PP napunjenog sa 30% talka
- Display digitalni segmentirana prekidačem stand-by i br. 5 led stanja. Sondanivoa. Zaštita IP 65. napajanje standard 230 Vac. Made in Italy
- *Peristaltic digital pump, proportional with built-in pH tool*
- *Definition of the range of proportionality - Proportionality of the pump with break time/work, max 300 seconds*
- *Display of the value of Ph with 3-digit display, 7-segment*
- *Reading range of Ph from 0 to 14 - Indication of efficiency of probe*
- *Field of magnitude of the proportionality, predetermined to a value of 1 pH*
- *Suitable for dispensing products pH + and pH - (acid and basic) by software*
- *Calibration of the semi-automatic probe - Stainless PP filled with 30% talc*
- *Front panel in polycarbonate - Digital display with segments and stand-by button and 5 status LEDs - Level Probe - IP 65 - Standard power supply 230 Vac - Made in Italy*

Šifra / code	Opis /description	Cena/ price
1075153	Peristaltička pH dozirna pumpa za javnost PR 4pH/ Peristaltic dosing pump pH for public PR 4-ph	467,00 €

- Digitalna peristaltička pumpa, sa kontrolorom redox integrisanim redox

PUMPA ZA DOZIRANJE KISELINE PODEŠAVANJE TEČNOG HLORA REDOX
PUMP ACID DOSAGE REDOX LIQUID CHLORINE REGULATION

SERIJE DOS-CHEMICAL



- Proporcionalnost pumpe sa tempom pauza/rad, max 300 sekundi
- Vizualizacija vrednosti mV na display sa 3 cifre, 7 segmenti Range di lettura degli mV da 0 a 999. Pokazatelj efikasnosti sonde. Polje veličine proporcionalnosti predfiksirana vrednost od 100 mV
- Poluautomatska kalibracija sonde
- Set uređaja sa ubrizgavajućim ventilom od 1/2"
- Isporučena u kompletu sa elektrodom redox, tampon rastvor, 2 držača fi 50, nosača cevi i usisna cev rezervoara sa sondom nivoa. Made in Italy
- *Digital Peristaltic Pump with integrated redox controller*
- *Proportionality of the pump with break time/work, max 300 seconds*
- *Display of the value of mV 3 digit 7-segment reading range of 0 to 999 mV. Indication Probe efficiency. Field of magnitude of the proportionality fixed at a value of 100 mV*
- *Calibration of the probe semi-automatic. Accessory Kit with injection valve 1/2"*
- *Supplied complete with the electrode redox buffers solution, 2 sockets bracket D50, support for the pipe and suction nozzle for tank with level sensor. Made in Italy*

Šifra / code	Opis /description	cena/ price
1075154	Peristaltička dozirna pumpa redox za javnost PR 4rx/ Peristaltic dosing pump redox for public redox PR 4 rx	464,40 €

ELEKTROMAGNETSKA PUMPA PH
ELECTROMAGNETIC PH PUMP

SERIE DOS-CHEMICAL



- Elektromagnetna digitalna pumpa proporcionalnog doziranja
- Instrument pH ugrađen, Trenutni prikaz vrednosti pH bazena, automatsko prepoznavanje efikasnosti sonde pH
- Ugrađeni predozirni alarm u software radi izbegavanja viška hemijskog proizvoda u bazenu, u stanju da dozira proizvode pH + e pH - (kiseline i baze) kako po softwareu.
- Programiranje po celoj skali pH 0-14, Definicija ranga proporcionalnosti, Definicija broja impulsa unutar ranga di proporcionalnosti.
- Kutija od PP napunjena sa cca 30% talka, Frontalni panel od polikarbonata
- Segmentirani digitalni display sa prekidačem stand- 5 led di stanja, telo za pumpanje sa ručnim ispustom, Pumpajuće telo PVDF, utičnica schuko, prekidač ON/OFF, sonda nivoa, zaštita IP 65, standardno napajanje 230 Vac, Made in Italy.
- *Electromagnetic Digital Pump with proportional dosage*
- *Instrument for pH integrated on board - Instantaneous value of the pH of the water*
- *Automatic detection of efficiency of the pH probe*
- *Alarm of overdose built into the software to avoid the excess chemical in the tank*
- *Suitable for dispensing products pH + and pH - (acid and basic) by software*
- *Programming over the entire range of pH 0-14*
- *Definition of the range of proportionality. Definition of the number of pulses within the range of proportionality*
- *Stainless PP filled with 30% talc - Front panel in polycarbonate - Digital display segments and stand - by button and no. 5 status LEDs - Body pump with manual drain - Body Pump in PVDF - Plug SCHUKO - ON / OFF - Level Probe - IP 65 Standard power supply 230 Vac - Made in Italy*

Šifra / code	Opis / description	Šifra price
1075246	Elektromagnetna pumpa proporcionalnog doziranja pH EL 5 pH / Digital Electromagnetic pump with Proportional dosage pH EL 5 pH	556,00 €

ELEKTROMAGNETNA PUMPA REDOX
ELECTROMAGNETIC PUMP REDOX

SERIJE DOS-CHEMICAL



- Digitalna elektromagnetna pumpa proporcijalnog doziranja
- Instrument čitanja Redox ugrađen
- Trenutna vizualizacija Redox vrednosti bazena.
- Automatsko prepoznavanje efikasnosti sonde sonde Redoxa
- Ugrađen alarm predoziranja u software radi izbegavanja viška hemijskog proizvoda u bazenu.
- Nije podesna da dozira oksidirajuće supstance ili dehlorinatorske. Programiranje cele skale Redox 0-999 mV, definisanje ranga proporcionalnosti, definisanje broja impulsa unutar ranga proporcionalnosti, kutija od PP napunjena sa 30% talka, čeon panel od polikarbonata.
- Segmentirani digitalni ekran sa stand-by prekidačem i br. 5 led stanja pumpajućeg tela sa ručnim odzračivačem , pumpajuće telo od PVDF, Sonda nivoa, zaštita IP 65, standardno napajanje 230 Vac. Made in Italy
- *Electromagnetic Digital Pump with Proportional dosage*
- *Instrument for redox integrated on board - Instantaneous value of the redox of the water*
- *Automatic detection of efficiency of the redox probe - Alarm of overdose built into the software to avoid the excess chemical in the tank - Not suitable for dosing oxidant products or dechlorant -*
- *Programming over the entire range of redox 0-999 mV*
- *Definition of the range of proportionality - Definition of the number of pulses within the range of proportionality - Stainless PP filled with 30% talc*
- *Digital display segments and stand - by button and no. 5 status LEDs - Body pump with manual drain - Body Pump in PVDF - ON / OFF - Level Probe - IP 65 - Standard power supply 230 Vac - Made in Italy*

Šifra / code	Opis / description	Cena / price
1075245	Elektromagnetna digitalna pumpa a proporcionalnog doziranja redox EL 10 rx / Digital Electromagnetic pump with Proportional dosage redox EL 10 rx	556,00 €

PUMPA DOZIRANJA KISEONIKA
OXYGEN DOSING PUMP

SERIE DOS-CHEMICAL



- Digitalna peristatička pumpa za doziranje vodonik peroksida: automatizovano doziranje
- Jednostavno programiranje (dovoljno je samo upisati kapacitet bazena "m³" i satirada filtracije /dnevno); odgovara bazenima do 150 m³; zidna montaža; napon 230 VAC ed raspoloža zaštito IP65; odobrenje doziranja (pumpe za recirkulaciju) predispozicija nivoa; isporuka sa usisnom šipkom (mod. kratki) i sonda nivoa.

Šifra	Opis	cena
1075183	Set dozirne pumpe kiseonika PR 1.5 ox / Dosing pump set PR 1.5 ox	461,40 €

DOZIRNE PUMPE

PUMPA ZA DOZIRANJE PROTIV ALGI I FLOKULANT ALGICID AND FLOCCULANT DOSING PUMP

SERIE DOS-CHEMICAL



- Digitalna peristatička pumpa sa integrisanim tajmerom: sa jednom pločom fiksnog protoka.
- Automatsko punjenje. Isporuka sa šrafovim a sa plastičnom ručkom.
- Programirajući digitalni tajmer do 10 pokretanja dnevno gašenja radi odlučivanja o kvantitetu doziranja, različiti tip motora prigodan za zadatu aplikaciju.
- Prekidač ON-OFF, led statusa.
- *Digital peristaltic pump with integrated timer: paneling, fixed capacity*
- *Automatic priming. Supplied to screws with plastic knob, programmable digital timer upto 10 departures and daily off to decide the amount to be determined, a different type of engine suitable for the application intended.*
- *ON-OFF button, LED status.*

Šifra /code	Opis /description	Cena/price
1075132	Pumpa za doziranje protiv algi i flokulant peristatička PR2 tr/Peristaltic pump algicid and flocculant dosage PR 2tr	263,20 €

PUMPA ZA DOZIRANJE ESENCIJA ESSENCES DOSING PUMP

SERIE DOS-CHEMICAL



- Kostantna elektromagnetna digitalna pumpa (podesiv protok)
- Zaštita IP65
- Podesiva frekvencija od 0 do 180 pulsiranja u minuti.
- Telo pumpe sa ručnim odzračivačem za punjenje pod pritiskom
- Kutija i telo pumpe od PP ojačano sa 30% talca.
- Pumpajuća glava PVDF, garantuje bolju hemijsku kompatibilnost.
- Fiksiranje na zid sa zakačaljka (dotirano)
- Čeoni panel od polikarbonata.
- Kablo napona 2,5m.
- Set opreme sa kugličnim ventilima za ubrizgavanje i oprugom Hastelloy
- *Constant digital dosing pump (flow adjustable)*
- *Protection IP65*
- *Frequency adjustable from 0 to 180 beats per minute*
- *Manual air bleed pump for priming under pressure*
- *Cash and pump in PP reinforced with 30% talc*
- *PVDF head ensures optimum chemical compatibility*
- *Wall mounting bracket (included)*
- *Front panel in polycarbonate*
- *Power cord 2.5m*
- *Accessory kit with injection valve ball and spring in Hastelloy*

Šifra /code	Opis /description	Cena/price
1075165	Pumpa za doziranje esencija / aroma elektromagnetna -7l/h a 5 bar EI 7 cs/Peristaltic pump essence/flavoring electromagnetic-7l/5bar EI 7 cs	348,10 €

PUMPA ZA DOZIRANJE ESENCIJA NISKOG PRITISKA ESSENCE LOW PRESSURE DOSING PUMP

SERIE DOS-CHEMICAL



- Peristatička pumpa sa podesivim protokom 0-100%
- Zaštita IP65
- Automatsko odzračivanje
- Zidno fiksiranje sa zakačaljka (dotirano) Nosač valjaka od PBT
- Valjci od Derlin (samopodmazivači)
- Kablo napajanja 2,5m
- PR 2 cs: max 2 bar, preporučuje se za emocionalne tuševe
- PR 4 cs: max 1 bar, preporučuje se za generatore pare
- *Peristaltic pump with adjustable flow 0-100%*
- *Protection IP65*
- *Automatic Purge*
- *Wall mounting bracket (included)*
- *Needle holder PBT*
- *Needle in Derlin (lubricating)*
- *Power cord 2.5m*
- *PR 2 cs: max 2 bar, recommended for showers*
- *PR 4 cs: max 1 bar, recommended for steam generators*

Šifra /code	Opis /description	Cena/price
1075162	Pompa dos. essenze peristaltica a bassa pressione PR 2 cs per doccia emozionali/Peristaltic pump essence/flavoring low pressure PR 2 cs for emotional shower	135,30 €
1075135	Peristatička pumpa za doziranje esencije niskog pritiska PR 4 cs za turska kupatila i generatori pare/Peristaltic pump essence/flavoring low pressure PR 4 cs for Turkish bath and steam generator	135,30 €

DEHLO-R-APID: SET ZA DEHLORACIJU I TRETMAN VODE DECLO-R-APID: DECHLORINATION AND WATER TREATMENT KIT

NEW



DEHLO-R-APID omogućava dehlorisanje/tretman vode, na jednostavan i brz način, putem senzora protoka: jednostavni Protok tečnosti za tretman aktivira sistem koji je na raspolaganju U dve verzije, sa elektromagnetnom pumpom od 5 l/h ili sa peristaltičkom pumpom od 2 l/h.

Set podrazumeva:

- Dozimu pumpu proizvoda za dehloraciju
- objumicu 50 x 1/2"

Il kit DECLO-R-APID se lako instalira, pripremljen sa naponskim utikačem, vodootporni priključak IP68 za napajanje uređaja za doziranje si senzora protoka sa 3 m kbla. Dovoljno je instalirati na cevi prsten sa objumicom od 1/2" i spojiti senzor iz opreme: **DECLO-R-APID** je odmah spreman za upotrebu.

DECLO-R-APID enables the simple and immediate dechlorination/ treatment of water by means of a flow sensor: the simple passage of the fluid to be treated activates the system, which is available in two versions, with a 5 l/h electromagnetic pump or a 2 l/h peristaltic pump. The kit includes:

- dechlorination product dosing pump
- 50 x 1/2" bracket socket

The DECLO-R-APID kit is easy to install, prepared with power plug, IP68 watertight connection for feeding the dosing device and flow sensor with 3 m of cable. Simply install a collar with 1/2" bracket socket on the pipeline and place the supplied sensor on it, DECLO-R-APID is immediately ready for use.

Šifra / code	Opis /description	Napajanje/ Power supply	Napon senzora/ Sensor voltage	Cena/price
1075202	Declarapid 5 l/h – Elektromagnetni sistem / Declorapid 5 l/h - Electromagnetic system	230 V	24 V	680,00 €
1075203	Declarapid 2 l/h – Peristaltični sistem / Declorapid 2 l/h - Peristaltic system	230 V	24 V	560,00 €

DISINFEKCIJA I TRETMAN VODE ZA KADU ZA PRANJE NOGU DISINFECTION AND WATER TREATMENT FOR FOOTBATHS

SERIE DOS-CHEMICAL



- Elektromagnetna proporcionalna pumpa za brojilo zapremine izbacivača impulsa
- Može raditi u konstantnom modalitetu sa digitalnim regulisanjem pulsacija od 0 do 180
- Funkcija podele pulsacije dobijenih preko digitalnog signala "1/n" i množenje impulsa Od digitalnog signala "1xn"
- Digitalni segmentirani ekran sa tasterom stand-by i 5 led stanja. Telo pumpe sa ručnim oduškom za privlačenje pod pritiskom.
- Kutija i telo pumpe u PVDF. Zaštita IP 65
- Sigurnost i pouzdanost
- Set opreme sa ventilima inekcionim kuglastim e molla i opruga in hastelloy. Predispozicija za sondu nivoa. Usisna šipka sa sondom nivoa za zaustavljanja doziranja po isteku proizvoda

- *Proportional electromagnetic pump for pulse lance volumetric counter*
- *It can operate in constant either with a digital control of pulse from 0 to 180*
- *Function of division of the impulses received by digital signal "1/n" and multiplication of the impulses by digital signal "1xn"*
- *Digital display, segment with push button and 5 LED stand-by status. Manual air bleed pump for priming under pressure. Cash and pump body in PVDF. Protection IP 65. Safety and reliability*
- *Accessory kit with injection valve ball and spring in Hastelloy. Preparing for the level probe. Suction lance with level probe to stop dosing the finished product*

Šifra / code	Opis /description	Cena/price
1075136	Elektromagnetna pumpa dehlorisanje/dezinfekcija kade za pranje nogu EL 7 im / Electromagnetic pump dechlorination/disinfecting foot baths EL 7 im	366,50 €
BROJILLO ZA IZBACIVANJE IMPULSA/ NOZZLE PULSE COUNTER		
1075166	Brojilo izbacivanje impulsa 1/2" / Nozzle pulse counter 1/2"	115,70 €
1075167	Brojilo izbacivane impulsa 1 1/2" / Nozzle pulse counter 1 1/2"	395,50 €
1075168	Brojilo za izbacivanje impulsa 2" / Nozzle pulse counter 2"	579,80 €

SIMPLY POOL PH I HLOR
SIMPLY POOL PH AND CHLORINE

SERIE DOS-CHEMICAL



- Panel pH i hlor (redox), pokazne dimenzije širina 500 x dub. 180 x h. 540 mm
 - Termoformirani panel povezan elektro kablovima
 - Instrument ORP / REDOX ugrađen model PR s 2 rx
 - REDOX proporcionalan fiksiranom set pointu
 - Instrument PH ugrađen model PR s 1 pH proporcionalan fiksiranom podešavanju
 - Nosač protočne sonde sa predfilterom od 50 micron
 - Tampon rastvori pH 7 e 468 mV
 - Utičać shuko
 - Elektroda pH e redox korpus epoxy, kablo od 1 metra
 - Telo pumpe od polipropilena
- *Panel pH and chlorine (redox), dimensions width. 500 x depth 180 x h. 540 mm*
 - *Thermoformed panel electrically wired*
 - *Instrument of ORP/REDOX integrated model PR s 2 rx proportional to the set point fixed*
 - *Instrument of PH integrated model PR s 1 pH proportional to the set point fixed*
 - *Flow-through housings with 50 micron pre-filter*
 - *Buffer solutions pH 7 and 468 mV*
 - *Shuko plug*
 - *pH and redox electrode, epoxy body, 1 mt cable*
 - *Pump body made of polypropylene*

Šifra / code	Opis /description	Cena/ price
1075259	Pan. regulacije i doziranje SIMPLY POOL pH-redox Control panel and dosing SIMPLY POOL pH-redox	1.148,00 €

SIMPLY POOL PH I KISEONIK
SIMPLY POOL PH AND OXYGEN

SERIE DOS-CHEMICAL



- PanEL pH i kiseonik, indikativne dimenzije šir. 500 x dub. 180 x h. 540 mm
 - Termoformirani panel povezan elektro kablovima
 - Dozirna pumpa model PR 1,5 ox za doziranje hidrogenskog peroksida proporcionalan Zapremini bazena
 - Dozirna pumpa sa instrumentom pH ugrađenim model PR 2 pH. Pogodna za doziranje kiselih i bazičnih proizvoda
 - Proporcionalan fiksiranom podešavanju
 - Nosač protočne pumpe sa predfiletrom od 50 microns
 - Tampon rastvori pH 7-9
 - Utičnica shuko/
 - Elektroda pH telo epoxy, kablo od 1 m
- *Panel pH and oxygen, dimensions width. 500 x depth 180 x h. 540 mm*
 - *Thermoformed panel electrically wired*
 - *Dosing pump model PR 1,5 ox for hydrogen peroxide dosing proportional to the pool volume*
 - *Dosing pump with integrated pH instrument model PR 2 pH. Proportional to the set point fixed*
 - *Flow-through housings with 50 micron pre-filter*
 - *Buffer solutions pH 7 -9*
 - *pH electrode, epoxy body, 1 m cable*

Šifra / code	Opis /description	Cena/ price
1075260	Pan.regulacije i doziranja SIMPLY POOL pH-Kiseonik Control panel and dosing SIMPLY POOL pH-Oxygen	1.278,00 €

EASY POOL CLORO LIBERO-PH
EASY POOL FREE CHLORE-PH
SERIE DOS-CHEMICAL

- Panel PVC povezan elektro kablovima IP65
- Dimenzije indikativne širine. 540 x dub. 180 x h. 580 mm
- Pumpe dozirke peristaltičke, protok 6l/h
- Čitanje hlora cloro u ppm i trenutni prikaz pH na osvetljenom ekranu
- Ulazni priključak vode 8x12
- Senzor protoka per za stopiranje doziranja kada uređaj ne radi.
- Bloliranje doziranja Hlora sa vrednostima ph drugačijim od podešenih
- 3 modaliteta rada
- Konstantni, ON/OFF i proporcionalni

- *PVC panel electrically wired IP65*
- *Dimensions width. 540 x depth 180 x h. 580 mm*
- *Peristaltic dosing pumps, flow 6l/h*
- *Chlorine reading in ppm and instant display of pH with backlit display*
- *Inlet water 8x12*
- *Flow sensor to stop dosing if the system is off*
- *Chlorine dosing block with pH values different from the set point*
- *3 operation mode*
- *Constant, ON/OFF and proportional*

Šifra / code	Opis /description	Cena / price
1075262	EASY POOL regulisanje pH-cloro slobodni EASY Pool pH-free chlorine setting	2.639,00 €

SUPERIOR POOL SLOBODNI HLOR-PH
SUPERIOR POOL FREE CHLORE-PH
SERIE DOS-CHEMICAL

- Panel od PVC povezan elektro kablovima IP 65
- Dozirna pumpa EL 10 sa ugrađenim instrumentom sa trenutnim pregledom pH sa dva decimala
- Dozirna pumpa EL10 cl sa ugrađenom instrumentom sa trenutnim pregledom slobodnog hlora u p.p.m. sa dva decimala
- Filter od 50micron sa mrežicom koja se pere smešten u nosača-protlačne sonde model PRO H1C.
- Nosač protlačne sonde plexiglass za sondu di hlora bakar platina sa automatskim čišćenjem model PRO-HCG-CL3
- Priključci ulaza vode 8x12. Protočni senzor za zaustavljanje doziranja kod uređaja kada ne radi
- Alarm za predoziranje radi izbegavanja hemijskog proizvoda u bazenu. Podešavanje odloženog pokretanja
- Instrument kontrole pH sa kombinovanom elektrodom od platine, rang očitavanja 0-14 pH, telo epoxy, dugačko kablo 1 metar, temperatura 60°C. instrument kontrole hlora sa elektrodom bakar platina , rang di očitavanja 0-5 mg/l, telo plexiglass, slavina za uzimanje uzoraka
- *PVC panel electrically wired IP65*
- *Dosing pump EL 10 with integrated instrument with instant display of the pH up to two decimal places*
- *Dosing pump EL10 cl with integrated instrument with instant display of the free chlorine in ppm controller integrated*
- *50 micron washable mesh lodged in the probe holder*
- *Probe holder in plexiglass for probe in chlorine copper platinum with self-cleaning model PRO-HCG-CL3*
- *Inlet water 8x12. Flow sensor for stopping of the dosage if system doesn't work*
- *Alarm of overdosage to avoid excess of the chemicain the pool. Setting of the delay start*
- *PH electrode in platinum, body in epoxy. Chlorine electrode in copper platinum, body in plexiglass*

Šifra / code	Opis /description	Cena / price
1075250	SUPERIOR POOL regulisanje pH-cloro slobodni SUPERIOR Pool pH-free chlorine setting	3.373,00 €

NEW SUPERIOR POOL SLOBODNI HLOR - PH - FLOKULANT
NEW SUPERIOR POOL FREE CHLORE - PH - FLOCCULANT

SERIE DOS-CHEMICAL



OPCONALNO: Sonda temperature za trenutno čitanje vrednosti

OPTIONAL: Temperature probe for instantaneous reading of the value

- Panel pH, slobodnog hlora i flokulant. Unapred sklopljena dozirna tabla spremna za upotrebu, za kontrolu slobodnog hlora, pH i doziranja flokulanta sa pregledom trenutne temperature
- Protok pumpe pH 5l/h, pumpa Cl 10l/h, flokulant 2l/h
- Panel od PVC povezan elektro kablom IP65. Panel od PVC sa konekcijama elektro povezanim kablom unutar vodootporne kutijelP65
- Dozine pumpei mA sa Proporcionalnim doziranjem
- Instrument multiparametralni za čitanje pH i slobodnog hlora sa osvetljenim ekranom
- Pumpa timer za doziranje flokulanta protiv algi
- Senzor protoka za stopiranje doziranja Sa uređajem koji ne radi
- Elektroda pH sa telom Epoxy
- Relo pumpe od PVDF
- Sonde nivoa obuhvaćene
- Filter od 50 micron a sa mrežom za pranje, smešten u nosač protočne sonde za prečišćavanje vode
- Sonda statičnopotenc. smeštena u protočnu sondu od pleksiglasa
- Ulazni priključci 8 x 12
- Alarm za predoziranje radi izbegavanja Viška hemijskog proizvoda u bazenu
- Framework dosing pre-assembled ready to use, to control free chlorine, pH and flocculant dosing with instant temperature reading
- Flow pH pump 5l/h, Cl pump 10l/h, flocculant pump 2l/h
- PVC panel electrically wired IP65. PVC panel with electrical connections wired inside a tight cassette IP65
- mA dosing pumps with proportional dosing
- Multiparameter instrument for pH and free chlorine reading with backlit display
- Algicid and flocculant timer dosing pump
- Flow sensor for stopping the dosing system is shut down
- Electrode with Epoxy body
- PVDF pump body
- Level probe included
- Filter 50 micron mesh washable housed in the probe holder flow to purify the water inlet
- Probe holder for flow-through plexiglass chlorine probe
- 8 x 12 inbound attacks
- Alarm over dosage to avoid excess chemical in the tank

Šifra / code	Opis /description	Cena/ price
1075253	NEW SUPERIOR POOL (bez daljinskog) regulisanje ph-hlor slobodni-flokulant/free chlorine-flocculant setting (without remote control) SUPERIOR Pool pH-free chlorine setting	4.097,00 €
1075256	NEW SUPERIOR POOL (sa daljinskim upravljačem) regulisanje ph-hlor slobodni-flokulant/free chlorine-flocculant setting (with remote control)	4.669,00 €

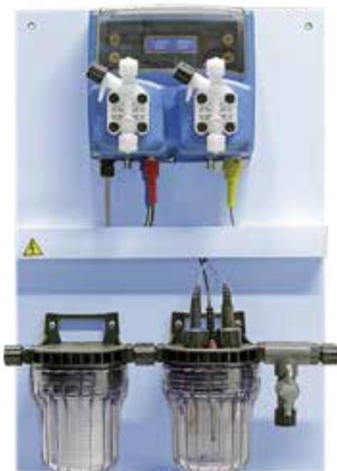
PANEL MONTIRANI MOD WPHRH
ASSEMBLED PANEL MOD WPHRH

Panel unapred-sklopljen za proporcionalno regulisanje pH iRedox (hlora)
Dimenzije 400 x 600 mm. Komponente panela:

- Instrument WPHRHD 05 05 5l/h
- Filter NFIL
- Sonda Redox ERHS
- Sonda pH EPHS
- Nosač elektrode NPED4

Pre-assembled Panel for proportional control of pH and Redox (chlorine).

Dimensions 400 x 600 mm. Components panel:

- Pool WPHRHD 05 05 5 l/h
- Filter NFIL
- Redox probe ERHS
- PH probe EPHS
- Gate electrode NPED4

Šifra /code	Opis /description	Cena/ price
1075069	Panel sklopljen model WPHRHD Assembled panel model WPHRHD	2.829,00 €

APARATI ZA VELIKE VODENE PARKOVE EQUIPMENTS FOR BIG AQUATIC PARKS



Veliki aparati elektrolizesolii hlorisanje pogodni za bazene velikih dimenzija, kao npr. U akvaparkovima za javnu upotrebu.

Big appliances for the electrolysis of salt and chlorination, suitable for swimming pools of large dimensions, such as those in public water parks.

Kontaktirajte nas za više informacija ili ponudu! Contact us for more information or quotations!

DOZATORI HLOORO I BROM TABLETE TABLETS DOSING CHLORINE AND BROMINE

Šifra / code	Opis /description	Cena/ price
1075088	DozatorMini,1,8kg. Tablete hlora -DosingMini,1.8 kg.ofchlorinetablets	143,00 €
1075195	DozatorKF50,8kg. Tablete hlora-DosingKF50,8kg.ofchlorinetablets	268,50 €
1075196	DozatorKF100,18kg.Tablete hlora-DosingKF100,18kg.ofchlorinetablets	337,60 €



cod.1075088



cod.1075195 - 1075196

DOZIRNE PUMPE/
DOSING PUMPS

KONTEJNERI ZA SMEŠTAJ I ULOŠCI ZA SMEŠTAJ SUPSTANCI DOZIRNIH PUMPI STORAGE TANKS AND DRIP PANS PRODUCTS DOSING PUMPS



Šifra/ code	Opis/description	Cena/ price
1075103	Kontejner za smeštaj supstanci dozirnih pumpi 55 litri / Tank 55 l	224,70 €
1075100	Kontejner za smeštaj supstanci dozirnih pumpi 110 litri / Tank 110 l	390,00 €
1075101	Kontejner za smeštaj supstanci dozirnih pumpi 215 litri / Tank 215 l	452,40 €
1075104	Kontejner za smeštaj supstanci dozirnih pumpi 555 litri / Tank 555 l	889,20 €
1075182	Uložak za kontejnere 55 litri / Drip pans for tank 55 l	496,10 €
1075187	Uložak za kontejnere 110 litri / Drip pans for tank 110 l	645,90 €
1075188	Uložak za kontejnere 215 litri / Drip pans for tank 215 l	717,60 €
1075189	Uložak za kontejner 555 litri / Drip pans for tank 555 l	1.294,80 €
1075185	Usisna šipka s sondom nivoa h60cm za kontejner od 55/110litara / Suction lance with level probe h 60cm for 55/110 l tank	140,40 €
1075186	Usisna šipka sa sondom nivoa h 80cm za kontejner od 220litara/ Suction lance with level probe h 80cm for 220 l tank	155,50 €
1075190	Usisna šipka sa sondom nivoa h 90cm za kontejner od 500litara/ Suction lance with level probe h 90cm for 500 l tank	204,40 €

Kontejneri su gradirani, osim 1075104, sa poklopcem na navoj

Tanks are sized, with the exception of 1075104, and fitted with a screw cap

Šifra / code	Opis /description	cena/ price
SONDE PH, KOMBINOVANA ELEKTRODA PH TELO OD PLASTIKE. ELEKTROLIT KCL 3 MOL/L GEL. RANGE ÷ 14PH. TEMPERATURA RADA 0÷50°C. PRITISAK RADA 2BAR / PH PROBES COMBINED PH ELECTRODE WITH PLASTIC BODY. TEMPERATURE: 0 TO 50°C. WORK PRESSURE 2 BAR.		
1075140	Sonda pH i kablo L=1 m - za panele montirane / pH probe with 1m cable for assembled panel	92,50 €
1075141	Sonda pH i kablo L=3 m - za dozirne pumpe / pH probe with 3m cable for dosing pump	92,50 €
1075142	Sonda pH e cavo L=5 m - za dozirne pumpe / pH probe with 5m cable for dosing pump	108,00 €
SONDE RX, KOMBINOVANA ELEKTRODA REDOX TELO OD PLASTIKE. ELEKTROLIT KCL 3 MOL/L GEL. RANGE +/- 2000MV +/- 20MV. TEMPERATURA RADA 0÷50°C. PRITISAK RADA 2 BAR PH PROBES- COMBINED REDOX ELECTRODE WITH PLASTIC BODY. TEMPERATURE: 0 TO 50 °C. WORKPRESSURE 2BAR		
1075143	Sonda Rx e cavo L=1 m - za montirane panele / Redox probe with L=1m cable for assembled panel	96,50 €
1075144	Sonda Rx e cavo L=3 m - za dozirne pumpe / Redox probe with L=3m cable for dosing pump	96,50 €
1075145	Sonda Rx e cavo L=5 m - za dozirne pumpe / Redox probe with L=5m cable for dosing pump	108,00 €
TERMOOTPORNOST, TELO OD STAKLA ZA MERENJE TEMPERATURE U BILOKOM AMBIJENTU I/ILI RASTVORU TERMO RESISTANCE - GLASS BODY FOR THE DETECTION OF THE TEMPERATURE		
1075150	Pretvarač temperature PT 100 / Temperature transducer PT 100	90,60 €
DRŽAČ SONDE PROTOKAZA ELEKTRODEPHI REDOXODPOLIPROPILENA. TEMPERATURAMAX90°C. PRITISAK MAKSIMALNI 3 BAR. FITTING CEVI OD 1/2" PROBE HOLDER FLOW PHAND REDOX, INPOLYPROPYLENE. MAXIMUMT 90°C. MAXIMUMPRESSURE 3 BAR. FOR TUBING OF 1/2"		
1075151	Držač sonde protoka za dve elktrode, filter i dvostruki nosač / Flow probe holder, filter, double bracket	166,00 €
1075152	Držač sonde protoka za jednu elektrodu, filter i jednostruki nosač / Flow probe holder, filter, single bracket	90,00 €
NOSAČ SONDE ZA CEVI OD 1/2" ODPOLIPROPILENA. PRITISAK MAX 3 BAR / HOLDER PROBE FORTUBING FROM 1/2" POLYPROPYLENE. MAXIMUM PRESSURE 3 BAR		
1075139	Nosač sonde PH/RX 1/2" / Probe holder PH/RX 1/2"	11,50 €
SONDA NIVOVA I NOSAČ / LEVEL PROBE AND LEVEL PROBE BRACKET		
1075177	Sonda nivoa plutajuće kablo 3 m / Level probe with 3 m cable	40,00 €
600-02456	Nosač sonde nivoa / Level probe bracket	3,90 €
AMPEROMETRIČKA ČELIJA ZA SLOBODNI HLOR OD 0A DO10 MG/L KOMPLET SA REKULISANJEM PROTOKAI NOSAČEM ELEKTRODE PH TEMPERATURE. KOMPLETNA SA SLAVINOMZA UZIMANJE KOMPARATIVNE ANALIZE. PRIKLJUČCI STANDARD 4X6 CELLMETERFORFREECHLORINEFROM0TO10MG/L COMPLETEWITHCONTROLFLOWANDELECTRODELEADS OFPHANDTEMPERATURE. COMPLETE WITHTAP WATERSAMPLING FOR COMPARATIVEANALYZES. STANDARD4X6 ATTACKS		
1075173	Amperometrička ćelija CG-CL3 i kablo, kompletna sa senzorom protoka / Amperometric cell CG-CL3, cable, complete fl	1.569,90 €
1075178	Amperometrička ćelijaa CG-CL3 I kablo, bez senzora protoka / Amperometric cellCG-CL3, cable, without flow sensor	1.300,30 €
POTENCIOSTATIČNA ČELIJA ZA SLOBODNI ORGANSKI ILI NEORGANSKI HLOR / POTENTIOSTATIC CELL FOR FREE CHLO- RINE ORGANIC OR INORGANIC		
1075176	Potenciostatična ćelija slobodnog neorganskog hlora 0,05-20ppm/ Potentiostaticcellfrom0.05to20ppmfree chlorine inorganic	2.258,00 €
1075164	Potenciostatična ćelija slobodnog organskog hlora 0,01-10ppm/ Potentiostaticcellfrom0.01to10ppmfreechlorine	2.821,30 €
TELO PUMPE SFERA PYREX-VITON / BODY PUMP PYREX SPHERE-VITON		
1075157	Telo pumpe PVDF za doziranje hlora - serie EL / PVDF pump body - for chlorine dosing - EL series	90,00 €
1075158	Telo pumpe polipropilene / Polypropylene pump body	42,10 €
USISNA ŠIPKA ZA KANISTERSA USISNIM FILTEROMI SONDOM NIVOVA/SUCTIONNOZZLE FOR CANISTER COMPLETE WITH INLET FILTER AND LEVEL SENSOR		
1075161	Usisna šipka+ sonda nivoa + filter. pada h50cmza kanister /Suction nozzle + level probe + bottom filth50cmfor canister	111,20 €
1075185	Usisna šipka+ sonda nivoa h60cm za kontejner60/108l / Suction lance + level probe h60cmfor60/108l tank	140,40 €
1075186	Usisna šipka + sonda nivoa h 80cm za kontejner 230 l / Suction lance + level probe h 80cm for 230 l tank	155,50 €
1075190	Usisna šipka + sonda nivoa h 90cm za kontejner 530 l / Suction lance + level probe h 90cm for 530 l tank	204,40 €
FILTER PODA OD POLIPROPILENE-USNI VENTIL-VITONTALKPRIKLJUČCI 4X6 / FILTER BOTTOM POLYPROPYLENE- VALVE-VITON TALC 4X6ATTACKS		
1075156	Filter pada / Filter bottom	13,30 €
VENTIL ZA UBRIZGAVANJE 1/2" SFERA PYREX-VITON / INJECTION VALVE FOR 1/2 "BALL-PYREX VITON		
1075159	Ventil za ubrizgavanje 1/2" polipropilene / Injection valve 1/2 "polypropylene	15,50 €
1075174	Ventil za ubrizgavanje 1/2" PP per pompe elettromagnetiche/ Injection valve 1/2" PP for electromagnetic pumps	9,30 €
1075160	Ventil za ubrizgavanje 1/2" PVDF - specifično za doziranje hlora / Injection valve 1/2 " PVDF-dosing Cl	23,40 €
ELEKTRODA ZA UZEMLJENJE AISI 316 1/2"G L=40MMZA DOZIRNE PUMPE/ EARTHING ELECTRODEAISI316 1/2" G L=40 MM FOR DOSING PUMPS		
1075179	Elektroda za uzemljenje AISI 316 1/2"G / Earthing electrode AISI 316 1/2" G	38,50 €



cod.1075140- 1075145



cod.1075151



cod.1075152



cod.1075173



cod.1075179



cod.1075158



cod.1075161



cod.1075156



cod.1075159



cod.1075160



cod.1075139



cod.1075177



cod.600-02456

Šifra/ Code	Opis/Descrizione	Cena/ Price
TAMPON RASTVOR ZA PH E REDOX / FOR PH AND REDOX BUFFER		
1075147	Tampon rastvor PH7 - bočica 50cc/ PH7 buffer solution - 50cc bottle	8,00 €
1075148	Tampon rastvor PH9 - bočica 50cc/ PH9 buffer solution - 50cc bottle	8,00 €
1075149	Tampon rastvor Redox 468 mV - bočica 50cc / Redox buffer solution 468 mV - 50cc bottle	10,00 €
1075081	Rastvor Redox 650 mv / Redox solution 650 mv	14,80 €

OPREMA ZA PUMPE / PUMP ACCESSORIES

Šifra / code	Opis/description	Cena/ price
EPHS		
1075072	Kombinovana elektroda za pH za pritiske do 7bar / 70°C (3.5 bar/80°C). Kablo dugo 0.8 m. Telo EPOXY (0 ÷ 14 pH) minimum 100µS/ Combined pH electrode for pressures upto 7bar/ 70°C (3.5°C bar/80). Cable length 0.8 m. Body in Epoxy (0 to 14 pH) at least 100 µS	214,80 €
ERHS		
1075073	Kombinovana elektroda Redox za pritiske do 7bar/70°C (3.5 bar/80°C). Kablo dugo 0.8 m. Korpo in EPOXY (0 ÷ 14 pH) minimum 100µS/ Redox combination electrode for pressures upto 7bar/70°C (3.5°C bar/80). Cable length 0.8 m. Body in Epoxy (0 to 14 pH) at least 100 µS	237,60 €
ETEPT		
1075076	Sonda temperature (0°C ÷ 100°C, max 10 bar) kablo L=5m/ Temperature probe (0°C to 100°C, max 10 bar) L=5m cable	99,90 €
NPED4		
1075074	Nosač elektrode protokaza dve elektrode EPH ERH sa telom in epoxy Ø12. Temperatura max 50°C, prit. max 5 bar sa senzorom protoka, kontakt N.O. fitting 6x8 / Gate electrode ERH EPH runoff for two electrodes with epoxy body Ø12. Maximum temperature 50°C, max 5 bar pressure with flow sensor, NO contact 6x8 fittings	308,90 €
PELC		
1075038	Nosač elektrode PVDF in linea per sonda pH/Redox da 1/2" o 3/4". Instalaciona utičnica za nosače PVDF electrode holder in line for pH/Redox probes 1/2 or 3/4". Installation of socket bracket	23,40 €
NFIL		
1075075	Filter sa ketrizima koji se mogu prati in PET (60µ) Raccordi 6x8 / Filter whit washable cartridge in PET	82,70 €
ECL 6/12		
1075077	Amperometrična ćelija za slobodni hlor od 0 do 10 mg/l. Kompletna sa regulacijom protoka i nosačem elektroda pH, Redox. Predisponirana za sonde temperature. Isporuka sa SEPR. Fiting 6x8 Amperometric cell for free chlorine from 0 to 10 mg/l Complete with adjustment flow and brings pH, Redox. Prepared for temperature probe. Supplied with SEPR. 6x8 Fittings.	2.250,50 €
SCL 8		
1075039	Amperometrična ćelija za totalni hlor (organski i neorganski) od 0 do 2 mg/l; da 0 a 20 mg/l, kompenzirana u temperaturi i pH/ Amperometric cell for total chlorine (organic and inorganic) from 0 to 2mg/l; from 0 to 20mg/l, temperature compensated and pH	2.078,70 €
SCL 3S/20		
1075078	Amperometrična ćelija za merenje slobodnog hlora (organski i neorganski), 0 ÷ 20mg/l, kompenzirana u temperaturi i pH/ Amperometric measuring cell for free chlorine (organic and inorganic), 0 to 20mg/l	2.250,50 €
SONDA DI LIVELLO / level probe		
1075079	Sonda nivoa sa podnim filterom i konektorom BNC takođe u verziji potpuno do PVDF prirodnog Level probe with BNC connector and bottom filter, version completely in natural PVDF	75,40 €

Šifra/ Code	Opis/Descrizione	Cena/ Price
FLEKSIBIKNE I POLUTVRDE CEVI/ flexible PVC transparent hose		
1070513	Providna cev PVC fleksibilni - Ø 2 mm int. x Ø 4 mm est. / flexible PVC transparent hose	al m 1,60 €
1070524	Providna cev PVC fleksibilni - Ø 3 mm int. x Ø 5 mm est. / flexible PVC transparent hose	al m 2,00 €
1070511	Providna cev PVC fleksibilni - Ø 4 mm int. x Ø 6 mm est. / flexible PVC transparent hose	al m 2,40 €
1070514	Providna cev PVC fleksibilni - Ø 5 mm int. x Ø 8 mm est. / flexible PVC transparent hose	al m 3,00 €
1070512	Providna cev PVC fleksibilni - Ø 8 mm int. x Ø 12 mm est. / flexible PVC transparent hose	al m 4,60 €
1075108	Polutvrda cev u teflonu - Ø 4 mm int. x Ø 6 mm est. / teflon hose	al m 14,80 €



cod.1075149



cod.1075072



cod.1075073



cod.1075076



cod.1075074



cod.1075038



cod.1075075



cod.1075077



cod.1075039



cod.1075078



cod.1075079

Cleaning and treatment
**ČIŠČENJE I
TRETMAN**



10



Sadržaj

PRAVILNA UPOTREBA BAZENA / CORRECT USE OF THE SWIMMING POOL

ČISTAČI/CLEANERS

- 422 HIDRAULIČNI I ČISTAČI NA BATERIJE / HYDRAULIC AND BATTERY-OPERATED CLEANERS
- 424 AUTOMATSKI ČISTAČI/ AUTOMATIC CLEANERS
- 426 AUTOMATSKI ČISTAČI ZA VELIKE BAZENE/ AUTOMATIC CLEANERS FOR BIG POOLS

ČIŠĆENJE / CLEANING

- 427 TELESKOPSKE DRŠKE/ TELESCOPIC HANDLES
- 427 KOMPLET ZA PORAVKU LAJNERA / REPAIR TROUSSE FOR LINER
- 428 PRIBOR ZA SKIMER / SKIMMER ACCESSORIES
- 429 MREŽICE / NETS
- 429 USISIVAČ PODOVA / SUCKS BOTTOM
- 430 KOMPLET ZA ČIŠĆENJE / CLEANING KIT
- 430 SAKUPLJAČ LIŠĆA / LEAVES COLLECTER
- 430 KUKA ZA SPASAVANJE / LIFE-SAVING COUPLING
- 431 OPREMA ZA ČIŠĆENJE PREMIUM / CLEANING ACCESSORIES PREMIUM
- 431 ČETKE ZA ZID / BRUSHES FOR WALL
- 432 PRIBOR ZA ČIŠĆENJE SERIE CPA / CLEANING ACCESSORIES CPA SERIES
- 432 PLUTAJUĆI RASPRŠIVAČI HLORA/ FLOATING CHLORINE DISPENSERS
- 433 TERMOMETRI / THERMOMETERS
- 433 PLUTAJUĆE CEVI / FLOATING TUBES

TESTER

- 434 TESTER DIGITALNI SCUBA / DIGITAL TESTER SCUBA
- 434 DIGITALNI FOTOMETAR / DIGITAL PHOTOMETER
- 434 TESTER U TRAKAMA I TROUSSE / STRIPS TESTER AND TROUSSE
- 435 TROUSSE I REZERVNI DELOVI KOMPLETA ZA TEST / TROUSSE AND SPARE PARTS FOR TEST KITS

HEMIJSKI PROIZVODI - CHEMICAL PRODUCTS

- 440 ALGICIDI / ALGAECIDES
- 440 HLOR / CHLORINE
- 441 FLOKULANTI / FLOCCULANTS
- 441 REGULATORI PH / REGULATORS OF PH
- 441 AKTIVNI KISEONIK I BROM / ACTIVE OXYGEN AND BROMINE
- 442 PROTIVKAMENCA / ANTISCALE
- 442 SPECIJALNI PROIZVODI / SPECIAL PRODUCTS
- 443 DETERDŽENTI POVRŠINE VODE / WATER LINE CLEANSER
- 443 ČIŠĆENJE PODA I ZIDOVA / SOIL AND WALLS CLEANING
- 443 STABILIZATOR HLORA / CHLORINE STABILIZER
- 443 ČIŠĆENJE FILTERA I CEVI / FILTERS AND PIPES CLEANING
- 443 OMRZIVAČ / WINTERING
- 444 MULTIFUNKCIONALNO DEZINFEKCIJSKO SREDSTVO / MULTI-FUNCTION DISINFECTANT
- 444 KOMPLET HEMIJSKIH PROIZVODA/ CHEMICAL PRODUCTS KIT
- 444 TRETMAN PROIZVODI SPA / SPA TREATMENT PRODUCTS
- 445 SOLI ZA ELEKTROLIZU/ SALT FOR ELECTROLYSIS
- 446 LINIJA LO-HLOR / LO-CHLOR LINE

**ZA DOBRO OČUVANJE I TRAJANJE MEMBRANE
FOR THE PRESERVATION AND DURABILITY OF THE MEMBRANE**



PUNJENJE BAZENA - Osim kada se koristi voda iz mreže ili iz pouzdanog izvora, vodu koja se koristi za punjenje bazena treba tretirati kako bi se osiguralo da ne sadrži rastvorljive metale, kao što su gvožđe, bakar ili mangan. **Metali kao što su gvožđe, bakar ili mangan ostavljaju talog koji može da isfleka membranu!**



NIVO VODE – Nivo vode u bazenu treba držati konstantnim tokom cele sezone korišćenja. Tokom zime, kada voda nije hemijski tretirana, nivo može da se poveća (kiša) ili smanji (da bi se bazen zaštitio od mraza). Delimično ispražnjeni bazeni treba da budu pokriveni kako bi se izbeglo zagađenje i oštećenja izazvana sunčevom svetlošću.

ODRŽAVANJE

Izbegavajte nagomilavanje ulja i naslaga prašine na površini vode koje bi mogle da proizvedu trajna estetska oštećenja membrane.

Preporučuje se redovno čišćenje naslaga ulja i prašine oko flotacione zone pomoću blago alkalnog ili neutralnog agensa za odmašćivanje. Naslage krečnjaka se mogu očistiti kiselim sredstvom za čišćenje, kao što je rastvor hidrohlorne kiseline od 5%. **Nikada ne koristite abrazivne materijale i proizvode za čišćenje !** Hemijske tretmane vodom treba rastvoriti i/ili razblažiti pre nego što se sipaju u vodu u bazenu i nikada ne bi trebalo da dođu u kontakt sa voodopornim lajnerom. Ako su tablete hlora koje se sporo rastvaraju u skimeru, pumpa za cirkulaciju mora redovno da se koristi.

Hemikalije nikada ne smeju biti u direktnom kontaktu sa voodopornim lajnerom!

**ZA DOBRO OČUVANJE I TRAJANJE LAJNERA
FOR THE PRESERVATION AND DURABILITY OF THE MEMBRANE**

TRETMAN VODE

Cloro / Hlor

Stabilizovan hlor (hlor izocijanurni derivati) treba dozirati na 0,7-1,2 mg/l (dostupan hlor, DPD- izmeren), pH 7,0-7,6. Nestabilizovani hlor (slobodni hlor, dobijen slanim hlorisanjem, natrijum hipohloritom itd.) treba da se dozira na 0,4-0,7 mg/l, pH 7,2-7,6. Preterano hlorisanje vode u bazenu može dovesti do promene boje lajnera. Tamne boje su osetljivije na dekoloraciju nego svetle boje. Dobra stabilnost boje lajnera se generalno postiže ako je temperatura vode u bazenu 27 °C ili manja. Ako želite da koristite bazen na višim temperaturama, obratite se graditelju bazena . **Preterano hlorisanje vode u bazenu može da izazove promenu boje lajnera!**



BROM

Bromini derivati se mogu koristiti kao manje nestabilna alternativa hemijskom hloru (bazeni sa toplom vodom). Preporučeni nivo bromina je 1-2 mg/l, pH 7-8.

Višak bromina u vodi u bazenu izaziva smeđu boju membrane koja će biti posebno primetna na laganim bojama!

OZON

Za bazene tretirane ozonom, zaostaci ozona u bazenu voda se mora držati pod 0,01 mg/l..



MERE PREDOSTROŽNOSTI - METALI

Hemikalije sa sadržajem bakra treba izbegavati jer postoji rizik od flekanja membrane. Proverite da li vaša algecid ne sadrži bakar.



- ČISTAČI

HIDRAULIČNI ČISTAČI



JOLLY

KARAKTERISTIKE | Funkcije

Cev od 10 m



WALLY

KARAKTERISTIKE | Funkcije

Cev od 10 m

SPA & STAIR CLEANERS



VA C

KARAKTERISTIKE | Funkcije

Čista površina	30 kvadratnih metara
Autonomija	1,5 h
Težina	0,3 kg



AQUA BROOM

KARAKTERISTIKE | Funkcije

Čista površina	30 kvadratnih metara
Autonomija	45 min
Težina	0,6 kg

ČISTAČI BEZ KABLOVA



CATFISH

KARAKTERISTIKE | Funkcije

Čista površina	30 kvadratnih metara
Autonomija	45 min
Težina	1,4 kg



PRO 1500

KARAKTERISTIKE | Funkcije

Čista površina	30 kvadratnih metara
Autonomija	2 h
Težina	4,3 kg



MOZZO ADVANCE TOP

KARAKTERISTIKE | Features

Dimenzije bazena pool size	100 m ²
zapremina vode Volume of water	20 m ³ /h
Dužina kabla cable length	18 m



MOZZO TOP SUPER 3000

KARAKTERISTIKE | Features

Dimenzije bazena pool size	100 m ²
Zapremina vode Volume of water	20 m ³ /h
Dužina kabla cable length	18 m



MAX 200

KARAKTERISTIKE | Features

Dimenzije bazena pool size	80 m ²
zapremina vode Volume of water	19 m ³ /h
Dužina kabla cable length	18 m
Ciklus čišćenja cleaning cycle	2 h



MAX 300

KARAKTERISTIKE | Features

Dimenzije bazena pool size	80 m ²
Zapremina vode Volume of water	19 m ³ /h
Dužina kabla cable length	18 m
Ciklus čišćenja cleaning cycle	1,5 - 2 h



MAX 400

KARAKTERISTIKE | Features

Dimenzije bazena pool size	80 m ²
Zapremina vode Volume of water	19 m ³ /h
Dužina kabla cable length	18 m
Ciklus čišćenja cleaning cycle	1,5 - 2 - 2,5 h



MAGNUM E MAGNUM JUNIOR

KARAKTERISTIKE | Features

	MAGNUM	MAGNUMJUNIOR
dimenzije bazena pool size	<300 m ² / 25 m	<200 m ² / 20 m
Zapremina vode Volume of water	19 m ³ /h	19 m ³ /h
Dužina kabla cable length	36 m	30 m



ULTRAMAX E ULTRAMAX JUNIOR

KARAKTERISTIKE | Features

	ULTRAMAX	ULTRAMAXJUNIOR
dimenzije bazena pool size	<1250 m ² / 50 m	<330 m ² / 30 m
Zapremina vode Volume of water	38 m ³ /h	38 m ³ /h
Dužina kabla cable length	45 m	36 m

HIDRAULIČNI ČISTAČI



cod.1055205 - Jolly



cod.1055207 - Wally

Automatski sistemi za čišćenje dno bazena:

- Spremni za 15 minuta
- Koriste sistem za filtraciju bazena
- Jednostavna instalacija, nisu potrebne alatke
- Pogodan za bazene sa ravnim dnom, kako u zemlji tako i nadzemni, veličine 4x8
- Za optimalni učinak potrebna im je pumpa od najmanje 0,75 hp
- Isporučeno sa crevom od 10 m

Šifra/kôd	Opis	cena
1055205	JOLLY automatski čistač	197,70 €
1055207	WALLY automatski čistač	302,50 €

SPA VAC NA BATERIJE ZA HIDROMASAŽNI BAZEN I STEPENICE



SpaVac čistač nudi mogućnost mikrofiltriranja vode iz spa i malih bazena uz uklanjanje čak i najmanje prljavštine ili otpadaka. Patentirani dizajn ima ventil koji blokira vraćanje svih otpadaka čim se usisaju. Jednostavan je, lagan i jednostavan za upotrebu. Kompletan set sadrži rasteznu šipku za lakše, obimnije čišćenje. Dizajniran je i testiran tako da ima maksimalnu autonomiju, čime se omogućavaju značajne uštede. Usisava duže od sat vremena sa samo 3 C-ćelijske baterije.

TEHNIČKE INFORMACIJE

- Čista površina 30 kvadratnih metara
- Trajanje baterije: do 1,5 sati
- Usisna širina glave: 9 cm
- Dimenzije: 38.5x8x8.90 cm
- Težina: 0,3 kg

Šifra/kôd	Opis	Cena
1055225	Električni čistač na baterije SPA VAC	86,70 €



Aqua Broom čistač vam omogućava da za kratko vreme očistite male bazene, banje i automatske PREKRIVKE. Uključuje kesu filtera koja se može ponovo koristiti, 4-delnu šipku, 2 usisne glave.

TEHNIČKE INFORMACIJE

- Litijumski napajanje, potpuno punjivo
- Trajanje baterije: do 45 minuta
- Usisna širina glave: 10 x 4 cm
- Dugme prekidača ON/OFF

Šifra/kôd	Opis/opis	Cena 156,30
1055229	AQUA BROOM električni čistač na baterije	

CATFISH

NOVI DESIGN

NEW DESIGN



Kombinujući prenosivi lagani dizajn sa velikim kapacitetom usisavanja i čišćenja, čistač Catfish je idealni aparat za bazene i spa. Glava se može ukloniti, čineći aparatosposobljenim da nesmetano čisti uglove i pukotine bez prepreka, štedeći vreme i energiju.

Catfish se napaja ponovo punjivim baterijama, usisava i šljunak i lišće, otpadke i druge vrste prljavštine skladišteći sve u kesu koja se može ponovo koristiti. Čistač Catfish se preporučuje i za čišćenje automatskih prekrivki.

Combining a lightweight, portable design with great suction and cleaning power, the Catfish is the ideal tool for pools and spas. The head can be removed, making the device able to clean corners and crevices smoothly, saving time and energy. The Catfish is powered by rechargeable batteries, it cleans dirt, leaves, and other types of debris, all collected in its reusable filter bag. Catfish cleaner is also recommended for the cleaning of automatic covers.

TEHNIČKI PODACI

- Punjač baterija dotiran
- Autonomija: do 45 minuta
- Širina usisne glave: 20 cm
- Dimenzije : 28x11x9 cm
- Težina: 1,4 kg

TECHNICAL INFORMATION

- Chargers included
- Run time: up to 45 minutes
- Vacuum head width: 20 cm
- Unit Size: 28x11x9 cm
- Unit Weight: 1,4 kg

Šifra/code	Opis/description	Cena/price
1055239	Električni čistač na baterije CATFISH Battery powered pool cleaner CATFISH	278,00 €

PRO 1500



Čistač PRO 1500 je čistač na baterije projektovan za profesionalno čišćenje.

Usisava velike otpadke i filtrira male sa svojim isporučnim mikro filtrirajućim kesama autonoman je i može biti povezan teleskopskoj šipki ili manevisan ugrađenom ručkom radi veće preciznosti. Priloženi su tri filter kese i dve zamenljive baterije. Široka glava za čišćenje radi boljeg usisavanja.

The cleaner PRO 1500 is a battery powered unit designed for a professional cleaning. It vacuums debris and filters small debris with its included micro filter bags. It is self-contained and can be attached to a standard pool pole or maneuvered using the integrated handle for greater precision. Included with every PRO 1500 are three filter bags and two interchangeable battery packs. Large head for means greater suction.



TEHNIČKI PODACI

- Autonomija: do dva 2 sata
- Širina usisne glave: 48 cm
- Dimenzije : 61 x 30,5 x 28,7 cm
- Težina: 4,3 kg

TECHNICAL INFORMATION

- Run time: up to 2 hrs.
- Vacuum head width: 48 cm
- Unit Size: 61 x 30,5 x 28,7 cm
- Unit Weight: 4,3 kg

Šifra/code	Opis/description	Cena/price
1055228	Električni čistač na baterije PRO 1500 Battery powered pool cleaner PRO 1500	2.077,00 €

ROBOT MOZZO ADVANCE TOP

NEW



Robot čistač programiran za čišćenje, usisavanje automatsko prljavštine i otpadaka sa dna bazena i zidova. U potpunosti čisti rezidencijalne bazene. Jednostavnost pristupa filteru postavljenog u gornji deo robota.

Cleaning robot programmed to clean, automatically sucking dirt and debris from the bottom and walls. Cleans completely residential pools. Easy of access to the filter in the upper part of the robot.

TEHNIČKI PODACI

- Dimenzije bazena: do 100 m²
- Zapremina filtrirane vode 20 m³/h
- Motor Breezer vuča/usisavanje napajanje 12 V dc
- Filtrira do 2 micron
- Dužina kabla: 18 metara
- Garancija 2+1 godina
- Specijalni sušeri za PVC i pločice
- Dotiran sa filterom HYPERFINE za brzo i higijensko čišćenje
- Transportna kolica
- Tabla sa transformatorom niskog napona mod. Saturn

TECHNICAL INFORMATION:

- Pool size: up to 100 m²
- Volume of water filtered 20 m³ / h
- Breezer motor drive/suction: 12 V dc
- Filters up to 2 microns
- Cable length: 18 meters
- Warranty 2 years + 1
- Special sponges for PVC and tiles
- Equipped with HYPERFINE filter for quick and hygienic cleaning
- Transport trolley
- Control panel with low voltage transformer mod. Saturn

Šifra/ code	Opis/description	Cena/price
1055322	Mozzo Advance TOP	1.636,00 €

ROBOT MOZZO TOP SUPER 3000

NEW



Inovativni robot čistač programiran za automatsko čišćenje i usisavanje prljavštine i otpadka sa dna i zidova. **ZA UPRAVLJANJE direktno sa svog mobilnog aparata sa personalizovanom aplikacijom preko konekcije Bluetooth.** U potpunosti čisti rezidencijalne bazene. Lak pristup filteru postavljenom u gornjem delu robota.

*New Cleaning robot programmed to clean, automatically sucking dirt and debris from the bottom and walls. **Mobile control by app, thanks to the Bluetooth connection.** Cleans completely residential pools. Ease of access to the filter in the upper part of the robot.*

TEHNIČKI PODACI

- Dimenzije bazena: do 100 m²
- Zapremina filtrirajuće vode 20 m³/h
- Motor Breezer vuča/usis napajanje 12 V dc
- Filtrira do 2 micron
- Dužina kabla: 18 metara
- Garancija 2+1 godina
- Specijalni sušeri za PVC i pločice
- Sa filterom HYPERFINE za jedno čišćenje Brzo i higijensko
- Transportna kolica
- Tabla sa transformatorom niskog napona model JUPITER sa Bluetooth

TECHNICAL INFORMATION

- Pool size: up to 100 m²
- Volume of water filtered 16 m³ / h
- Drive motor: 24 V dc
- Suction motor: 24 V dc
- Filters up to 2 microns
- Cable length: 18 meters
- Warranty 2 years + 1
- Special sponges for PVC and tiles
- Equipped with two filtering cups for rapid and hygienic cleaning
- Transport trolley
- Control panel with low voltage transformer JUPITER model with Bluetooth



Šifra/ code	Opis/description	Cena/price
1055321	Mozzo TOP SUPER 3000	1.786,00 €

MAX 200

Čistač robota programiran da automatski čisti, usisava prljavštinu i opadke sa dna stambenih bazena. Lak pristup duplom ležištu koji se nalazi na vrhu robota.

**TEHNIČKE INFORMACIJE**

- Veličina bazena: do 80 m²
- Maksimalna preporučena veličina: 12m
- Filtrirana zapremina vode 19 m³/h
- Pogonski motor: 24 V
- Usisni motor: 24 V
- Filteri do 2 mikrona
- Dužina kabla: 18 metara
- Garancija: 2 godine
- Specijalni suđeri za PVC i pločice
- Opremljen dvostrukim ležištem za filtere za brzo i higijensko čišćenje
- Komandna tabla sa transformatorom niskog napona

Šifra	Opis	cena
1055315	Max 200 kompletan kablom 18m	€1,595.00

MAX 300

Čistač robota programiran da čisti, automatski usisava prljavštinu i otpadke sa dna i zidova stambenih bazena. Lak pristup duplom ležištu koji se nalazi na vrhu robota.

**TEHNIČKE INFORMACIJE**

- Veličina bazena: do 80 m²
- Maksimalna preporučena veličina: 12m
- Filtrirana zapremina vode 19 m³/h
- Pogonski motor: 24 V
- Usisni motor: 24 V
- Filteri do 2 mikrona
- Dužina kabla: 18 metara
- Garancija: 2 godine
- Specijalni suđeri za PVC i pločice
- Opremljen dvostrukim ležištem za filtere za brzo i higijensko čišćenje
- Transportna kolica
- Komandna tabla sa transformatorom niskog napona

Šifra	Opis	Cena
1055316	MAX300 kompletan sa kolicima i kablom od 18m	1.779,00 €

MAX 400

Čistač robota programiran da čisti, automatski usisava prljavštinu i otpadke sa dna i zidova stambenih bazena. Može se kontrolisati direktno sa mobilnog uređaja pomoću personalizovane aplikacije putem Bluetooth veze. Lak pristup duplom ležištu koji se nalazi na vrhu robota.

**TEHNIČKE INFORMACIJE**

- Veličina bazena: do 80 m²
- Maksimalna preporučena veličina: 12m
- Filtrirana zapremina vode 19 m³/h
- Pogonski motor: 24 V
- Usisni motor: 24 V
- Filteri do 2 mikrona
- Dužina kabla: 18 metara
- Garancija: 2 godine
- Specijalni suđeri za PVC i pločice
- Opremljen ležištem za dvostruke filtere za brzo i higijensko čišćenje
- Transportna kolica
- Prekidač sa transformatorom Niskog napona

Šifra	Opis	Cena
1055317	MAX400 kompletan sa kolicima i kablom od 18m	€1,972.00

Čistači robota programirani da čiste, automatski usisavaju prljavštinu i otpadke sa dna. Potpuno čiste velike bazene. Dizajniran za pouzdani i bez problema rad.

ROBOT MAGNUM - MAGNUM JUNIOR



cod.1055216



cod.1055213



TEHNIČKE INFORMACIJE :

- Veličina bazena: Magnum <300 m²/25 m / Magnum Jr <200 m²/20 m
- Filtrirana zapremina vode 19 m³/h
- Filteri do 2 mikrona
- Dužina kabla: Magnum 36 metara / Magnum Jr 30 metara
- 2 x 24 V motori
- Garancija: 3 godine

Šifre	Opis	Cena
1055216	Magnum upotpunjen kolicima i kablom od 36 m	6.197,00 €
1055213	Magnum Junior kompletan sa kolicima i kablom od 30 m	4.901,00 €

ROBOT ULTRAMAX - ULTRAMAX JUNIOR



cod.1055221



cod.1055214

TEHNIČKE INFORMACIJE :

- Veličina bazena: Ultramax <1250 m²/50 m / Ultramax Jr <330 m²/30 m
- Filtrirana zapremina vode 38 m³/h
- Filteri do 2 mikrona
- Dužina kabla: Ultramax 45 metara / Ultramax Jr 36 metara
- 2 x 24 V motori
- Garancija: 2 godine

Šifre	Opis	Cena
1055221	Ultramax kompletan sa kolicima i kablom od 45 m / Ultramax	€12,236.00
1055214	Ultramax Junior kompletan sa kolicima i kablom od 36 m	9.877,00 eur

DODATNA OPREMA

Šifra/kôd	Opis/opis	količina	Cena
KOMPLET ZA POPRAVKU LAJNERA / LINER REPAIR KIT			
1055006	Komplet za popravku linera i prekrivki(cerada+lepak)		6,80 € ind.
DODATNA OPREMA			
1055003	Zamenske kopče nosača (4 komada)		2,00 € ind.
1055506	Zamenske kopče nosača (4 komada)	Kutija 12kom	18,40 € ind.
1055004	Zamenski klin nosača (4 komada)		1,30 € ind.
1055013	Zamenski klin nosača (4 komada)	Karton 12kom	11,10 € ind.
1055005	Zamenski nosač usisivača za lajner liner		1,90 € ind.
1055505	Zamenski nosač usisivača za lajner	Karton 12kom	16,50 € ind.
1055009	Zamenski nosač za usisivač betona 1055093		4,30 € ind.



cod.1055006



cod.1055003



cod.1055005



cod.1055004

TELESKOPSKJE DRŠKE

Šifra	Opis	količina	cena
Plave eloksirane aluminijumske drške - 2 dela			
1055010	Teleskopska drška od 2.40 do 4.80 m		44,80 €
1055511	Teleskopska drška od 2.40 do 4.80 m	Kutija 10 kom	336,20 €
1055012	Teleskopska drška od 1.20 do 2.40 m		28,40 € .
1055510	Teleskopska drška od 1.20 do 2.40 m	Kutija 20kom/	425,90 €
Drške od ojačanog eloksiranog aluminijuma - 2 dela		količina	
1055015	Teleskopska drška od 7,5 m		482,10 €
Drške od plavog eloksiranog aluminijuma - 3 dela Delove		količina	
1055021	Teleskopska drška od 1.00 do 3.00 m		26,50 €
1055512	Teleskopska drška od 1.00 do 3.00 m	Kutija 20kom	397,00 € .
1055020	Teleskopska drška od 3.00 do 9.00 m		69,80 €
1055103	Teleskopska drška od 3.00 do 9.00 m	Kutija 20pcs	€1,046.70



Aluminijumska drška

OPREMA ZA SKIMER / SKIMMER ACCESSORIES



TORBA ZA BAZEN cod. 1070021
Torba od poliestera TNT, višenamenske upotrebe.
POOL BAG Bag made of polyester non-woven, reusable.



POOL'GOM cod. 1070028
Nije sundereć guma koja eliminiše Sve tragove i zakorele fleke na plastičnim materijalima. Posebno efikasan za čišćenje površine vode i za svu plastičnu opremu. Prodaje se u kutiji sa tri velike gume.

POOL'GOM is not a sponge but a rubber that eliminates all traces and stains encrusted on plastics. It is particularly effective for cleaning the water line and all plastic accessories. It sold in boxes of 3 large tires.



NET'SKIM cod. 1070022
Jednokratni higijenski prefilteri od cca 150 microns koji se postavljaju oko korpe skimera kako bi se zadržala većina nečistoća srednjih i velikih dimenzija, sačuvavajući filter.

NET'SKIM Hygienic prefilter "disposable" of about 150 microns to be placed around the skimmer basket so as to retain the majority of the impurities of medium and large size, preserving the filter.



POOL'GOM XL cod. 1070240
Velika guma (25x9 cm) visoke gustine, na specifičnom držaču prilagodljivom tradicionalnim ručkama. Idealna za najteže fleke njena velika površina joj daje veliku moć čišćenja.

POOL'GOM large rubber (25x9cm) with high density, on a specific support adaptable to traditional handles. Ideal for the toughest stains its large surface gives a strong cleaning power.



WATER LILY cod. 1070026
Je upijač masnih ostataka. Postavlja se na površini vode u skimer, upija i zadržava masne supstance koje se talože i održavaju na površinama bazena izazivajući otporne crne mrlje na površini vode.
Trajanje: od 4 do 6 nedelja.

WATER LILY is an absorbent of fats waste. It rests on the surface of the water into the skimmer, it absorbs and retains the fat that is deposited on the surfaces of swimming pools and persists, causing persistent deposits blacks on the water line. Duration: 4 to 6 weeks.



EASY POOL'GOM cod. 1070242
Za efikasno čišćenje fleka i prljavštine zakorene na površini vode, prekrivkama, roletnama, itd. Jednostavna za upotrebu da se koristi zahvaljujući Anatomskoj ručki i obliku.

To effectively clean stains and dirty caked on the water line, covers, roller shutter, etc .. Easy to use thanks to its ergonomic handle and to the format.



SKIM VAC cod. 1070024
Univerzalni sa bočnim izlazom rif. SV 200
Universal Skim Vac exit ref. SV 200



SET ZA PUŠTANJE U RAD cod. 1070244
Osnovni komplet za puštanje u rad bazena. Sadrži : 2 NET'SKIM, 2 WATER LILY e 1 POOL'GOM.

An essential kit for starting the pool. Contains: 2 NET'SKIM, 2 WATER LILY and 1 POOL'GOM.



Rezervni sunderi POOL'GOM XL
REPLACEMENT BRUSHES FOR POOL'GOM XL
cod. 1070241



Špric ABS cod. 1070023
Tečnost za poravku svih delova od ABS
ABS syringe of liquid for the repair of all parts in ABS



Šifra/ code	Opis/description	Količina/quantity	Cena/ price
1070021	TORBA ZA BAZEN od poliestere koja se pere, kompletna / POOLBAG washable in polyester	kutija 3 kom/ carton 3 pcs	76,80 €
1070022	NET'SKIM koristi i baci / NET'SKIM disposable	Kutija 12 kom / carton 12 pcs	23,00 €
1070026	WATER LILY upijač masnih ostataka / WATER LILY absorption of fat residues	kutija 6 kom / carton 6 pcs	19,80 €
1070028	POOL'GOM gume magične za površinu vode / POOL'GOM magic rubber for the water line	kutija 3 kom / carton 3 pcs	13,40 €
1070240	POOL'GOM XL velika magična guma na podesivom nosaču teleskopskih ručki / POOL'GOM XL big magic rubber on adjustable support to telescopic handle		41,40 €
1070241	Rezervni sunder POOL'GOM XL / replacement brushes for POOL'GOM XL		13,80 €
1070242	EASY POOL'GOM praktična i magična guma za površinu vode / EASY POOL'GOM practical and magic rubber for the water line		21,00 €
1070243	Rezervni sunder EASY POOL'GOM / replacement brushes for EASY POOL'GOM		9,80 €
1070023	Špric ABS tečni za poravku svih komada od ABS / ABS syringe of liquid for the repair of all parts in ABS		56,80 €
1070024	Skim-Vac universale sa bočnim izlazom / universal Skim-Vac side exit		11,40 €
1070244	Starter komplet/ starter kit		13,80 €

MREŽICE / NETS

Šifre	Opis/opis	količina	cena
POVRŠINSKA MREŽA			
1055131	PVC površinska mreža, dužina drške 1.22		10,70 €
1055547	PVC površinska mreža, dužina drške 1.22	Kutija 24kom	192,00 €
1055132	Površinska mreža u PVC / Površinska mreža u PVC-u		4,70 €
1055545	Površinska mreža u PVC / Površinska mreža u PVC-u	Kutija 24kom	84,40 €
1055133	Površinska mreža lux ram od aluminijuma		12,80 €
1055546	površinski mrežica lux ram od aluminijuma	Kutija 24kom	231,10 €
1055168	Površinska mreža velikog kapaciteta		11,20 €
1055549	Površinska mreža velikog kapaciteta	Kutija 24kom	200,30 €
MREŽICA ZA DNA			
1055134	Mreže za dna u PVC /		7,60 €
1055550	Mrežica za dna u PVC /	Kutija 12kom	68,10 €
1055035	Mreža za dna Luxe u aluminijumu		13,40 €
1055551	Mreža za dna Luxe u aluminijumu	Kutija 24kom	241,20 €
1055097	Mreža za dna velikog kapaciteta		14,30 €
1055552	Mreža za dna velikog kapaciteta	Kutija 12kom	128,80 €



cod.1055131



cod.1055132



cod.1055133



cod.1055134



cod.1055035



cod.1055097

USISIVAČ DNA ZA BETON

1055093	Usisivač za cement sa 4 kastora - corpo alluminio / Usisava dno za cement		72,60 €in
1055535	Betonski usisivač sa 4 točka – telo od aluminijuma	Kutija od 4kom	217,60 €i
1055112	Četkice rezervne za usisivač 1055093		3,80 €
1055102	Usisivač za dna FAIRLOCK liner/betonski usisivač (48 cm) sa četkicama i točkicama		255,00 €



cod.1055093



cod.1055102

USISIVAČ ZA LAJNER

Šifre	Opis	/količina	Cena
1055106	Usisivač za trouglasti balastni liner		18,80 €
1055536	Usisivač za trouglasti balastni liner	Kutija 6kom	84,60 €
1055107	Četkice rezervne za usisivače 1055106		3,00 €
1055105	Usisivač za trouglasti balastni liner sa bočnim četkama		23,80 €
1055538	Usisivač za trouglasti balastni liner sa bočnim četkama	Kutija 12kom/	218,60 €
1055110	Usisivač za liner za nadzemne bazene		10,50 €
1055129	Usisivač za liner za nadzemne bazene	Kutija 12kom/	94,30 €
1055111	Usisivač lux za providne trouglaste liner		35,00 €
1055537	Usisivač lux za providni trouglasti liner	Karton 6pcs/karton 6pcs	157,50 €



cod.1055106



cod.1055107



cod.1055105



cod.1055110



cod.1055111

PRIBOR ZA ČIŠĆENJE



KOMPLET 1 STANDARD KOJI SE SASTOJI OD:

- 1 mrežica PVC površinska
- Četka za zid od 1 x 45 cm PVC
- 1 trouglasti balastni usisivač
- 1 plutajuća cev 12 m Ø 38
- 1 teleskopska drška od 2.40 do 4.80 m
- 1 x Beli plutajući termometar
- 1 test komplet za hlor i tečni PH



KOMPLET 2 LUXE KOJI SE SASTOJI OD:

- 1 x površinska mrežica lux ram aluminijum
- 1 x mrežica dna lux ram aluminijum
- 1 zidna četka 45 cm Al ojačana
- 1 četka za površinu vode
- 1 x Luxe trouglasti providni usisivač
- 1 plutajuća cev 12 m Ø 38
- 1 teleskopska drška od 2.40 do 4.80 m
- 1 x Beli plutajući termometar
- 1 test komplet za hlor i tečni PH



KOMPLET 3 MINI KOJI SE SASTOJI OD:

- 1 Trouglasti usisivač linera
- 1 zidna četka 26 cm
- 1 površinski mrežica
- 1 x Džambo termometar

KOMPLET 4 - 7 KOMADA KOJI SE SASTOJE OD:

- 1 PVC površinska mrežica
- 1 PVC mreža dna
- Četka za zid od 1 x 45 cm PVC
- 1 četka za površinu vode
- 1 trouglasti balastni usisivač
- 1 x Beli plutajući termometar
- 1 test komplet za hlor i tečni PH

Šifra	Opis	količina	cena
1055001	Standard kompleta 1		188,30 €
1055002	Komplet 2 Luxe		235,50 €
1055086	Komplet 3 mini		32,00 €
1055113	Komplet 3 mini	Kutija 6 kom/	144,00 €
1056000	Komplet 4 - 7 komada		54,80 €
1055575	Komplet 4 - 7 komada	Kutija 6 kom/	247,00 €

KUKA ALUMINIUMSKA ZA SPASAVANJE



Šifra	Opis	cena
1055024	Kuka za spasavanje	30,20 €

SAKUPLJAČ LIŠĆA

Šifra	Opis	količina	cena
1055141	Metla venturi sa točkićima i četkom		32,20 €
1055140	Metla venturi sa točkićima i četkom	Kutija 24kom	580,00 €
1055142	Metla venturi za male bazene		16,10 €
1055560	Metla venturi za malu metlu	Kutija 24kom	289,50 €
1055143	Rezervna kesa za venturi metlu 1055560		2,10 €



cod.1055141



cod.1055143

ČETKICE ZA ZID

Šifre	Opis	količina	cena
1055151	Četka 45 cm / Četka 45 cm		8,00 €
1055566	Četka 45 cm / Četka 45 cm	Karton 24pcs/ karton 24pcs	144,00 €
aluminijum			
1055152	Četka 45 cm / Četka 45 cm		14,40 €
1055565	Četka 45 cm / Četka 45 cm	Karton 24pcs/karton 24pcs	259,20 €
ČELIČNA ŽICA			
1055153	Luxe 26 cm / Luxe 26 cm		14,10 €
ČETKICE ZA POVRŠINU VODE			
1055155	Tapacirano četka sa posudom za čišćenje i napad za rukovanje		10,80
1055158	Zamena sundera za četkicu 1055155 1055155		7,20 €
1055156	Tapacirana četka za vodenu liniju		3,10 €
ČETKICE ZA UGAONI ZID			
1055157	Plastika za četke / Plastika četkice		5,40 €
1055150	Plastika za četke / Plastika četkice	Kutija 24kom	96,20 €
USISNE UGAONE ČETKE			
1055174	Usisne ugaone četke /		5,50 €
1055570	Usisne ugaone četke /	Kutija 24kom	98,40 €



PRIBORI ZA ČIŠĆENJE PREMIUM SERIJA

Šifre	Opis/opis	količina	cena
USISIVAČ			
1055700	Usisna okretna balastna glava		32,90 €
1055705	Usisna okretna balastna glava	Karton 6kom	148,30 €
MREŽICE/ NETS			
1055703	Površinska mreža velikog kapaciteta PVC		15,90 €
1055708	Površinska mreža velikog kapaciteta PVC	Kutija 6kom	71,50 €
1055702	PVC donja mreža velikog kapaciteta		19,90 €
1055707	PVC donja mreža velikog kapaciteta	Kutija 6kom	89,60 €
ČETKICA ZA DNO I ZID			
1055701	Četka 50 cm po fondo e paretu / Zid i donja četka 50 cm		22,60 €
1055706	Četka 50 cm po fondo e paretu / Zid i donja četka 50 cm	Kutija 6kom	101,60Eur
AUTOMATSKI ČISTAČ			
1055704	Automatski čistač PREMIUM sa 10 metara cevi		290,00 €



PRIBOR ZA ČIŠĆENJE CPA SERIJE

Šifra	Opis	cena
USISIVAČ DNA		
1055604	Više površinska velika vakuumska glava	29,00 €
MREŽICE / NETS		
1055600	Mreža PVC površine	4,60 €
/ ČETKICA ZA UGAO		
1055610	Angolo po angolu u plastici / Ugaona plastična četka	11,10 €
TERMOMETRI		
1055609	Termometar za lako čitanje	19,60 €



cod.1055604



cod.1055600



cod.1055610



cod.1055609

PLUTAJUĆI RASPRŠIVAČI HLORA

Šifra/kôd	Opis	količina	cena
1055098	Plutajući raspršivač hlora		6,60 €
1055525	Plutajući raspršivač hlora	Kutioja 12kom/	59,50 €
1055099	Plutajući raspršivač hlora mali model		3,20 €
1055137	Plutajući raspršivač hlora mali model		
1055079	Plutajući raspršivač hlora sa termometrom	Karton 12pcs/karton 12pcs	28,90 €
1055527	Plutajući raspršivač hlora sa termometrom		15,80 €
1055169	Plutajući raspršivač hlora sa termometrom model kornjača		
1055173	Plutajući raspršivač hlora sa termometrom model kornjača	Karton 12pcs/karton 12pcs	142,00 €
			20,50 €
		Karton 12pcs/karton 12pcs	184,20 €



cod.1055098



cod.1055099



cod.1055079



cod.1055169

VALOVITO OBLOŽENO CREVO/



Šifre	Opis	cena
1055355	Obložena valovita cev Ø 32 /	5,90 €
1055356	Obložena valovita cev Ø 38 /	7,80 €

TERMOMETRI

Šifre	Opis	količina	cena
1055072	Okrugli plutajući termometar Jim / Round floating thermometer Jim		5,00 €
105515	Okrugli plutajući termometar Jim / Round floating thermometer Jim	Kutija 12kom/karton 12pcs	44,80 €
1055170	Plutajući termometar Pinguino / Plutajući termometar Pingvin		9,80 €
1055518	Plutajući termometar Pinguino / Plutajući termometar Pingvin	Kutija 12kom/karton 12pcs	88,30 €
1055078	Plutajući termometar Animale / Plutajući termometar Životinja		6,40 €
1055071	Plutajući termometar Animale / Plutajući termometar Životinja	Kutija 12kom/karton 12pcs	57,50 €
1055074	Termometar Džambo lako čitanje / Termometar Džambo lako čitanje		5,00 €
1055516	Termometar Džambo lako čitanje / Termometar Džambo lako čitanje	Kutija 12kom/karton 12pcs	44,80 €
1055075	Termometar SCOOP / Thermometer SCOOP		3,70 €
1055104	Termometar SCOOP / Thermometer SCOOP	Kutija 12kom/karton 12pcs	33,10 €
1055613	Termometar LITTLE SCOOP / Thermometer LITTLE SCOOP		2,40 €
1055614	Termometar LITTLE SCOOP / Thermometer LITTLE SCOOP	Kutija 12kom/karton 12pcs	21,60 €
1055076	Okrugli plutajući termometar u boji		3,60 €
1055080	Digitalni termometar		24,60 €
1055521	Digitalni termometar	Karton 12pcs/karton 12pcs	221,40 €



cod.1055072



cod.1055170



cod.1055078



cod.1055613



cod.1055074



cod.1055075



cod.1055076



cod.1055080

PLUTAJUĆE CEVI 38 MM POOLFLEX



cod.1055114



cod.105125



cod.1055122



cod.1055121



cod.1055130

Šifre	Opis	cena
1055114	Prstenasta plutajuća cev 6 m Ø 38 sa konektorom	73,20 €
1055116	Prstenasta plutajuća cev 9 m Ø 38 sa konektorom	85,20 €
1055117	Prstenasta plutajuća cev 12 m Ø 38 sa konektorom	97,70 €
1055118	Prstenasta plutajuća cev 15 m Ø 38 sa konektorom	106,00 €
1055120	Prstenasta plutajuća cev 15 m Ø 38 sa konektorom	256,70 €
1055121	Fiting čepni cevi Ø 38 beli	3,70 €
1055122	Priključni Nosač gume plutajuće cevi	1,60 €
1055130	Priključak za koleno creva	4,20 €
1055125	Motalica Creva - Ø 38 (dužina 13 m max)	70,00 €

TESTER E TROUSSE U TRAKAMA / STRIPS TESTER AND TROUSSE

Šifra/ code	Opis/description	cena/ price
1055069	Kutija (za tester digitalni) slobodni hlor - pH – totalna alkalnost/50 strips / Test strip free chlorine, pH and total alkalinity	28,80 €
1055233	Kutija (za digitalni tester) brom/hlor slobodni-pH-totalna alkalnost/50 traka / Test strip bromine, pH and total alkalinity	27,70 €
1055027	Kutija hlor slobodni-pH-totalna alkalnost-cijanidna kiselina/50 traka /Test strip free chlorine, pH,tot.alkalinity, cyanuric acid	22,60 €
1055028	Kutija broma -pH - alcalinità totale - tvrdoća / 50 traka / Test strip bromine, pH, total alkalinity, total hardness	24,30 €
1055234	Kutija soli / 10 traka / Test strip salt	27,70 €
1055235	Kutija monopersulfato (aktivni kiseonik) - pH – totalna alkalnost / 50 strips /Test strip monopersulfate,pH, tot.alkalinity	25,20 €
1055232	Kutija shock check (merač potrebe šok tretmana) / 10 traka / Test strip shock test	12,80 €



cod.1055069



cod.1055234



cod.1055235



cod.1055232

TESTER DIGITALNI SCUBA
DIGITAL TESTER SCUBA



Tester digitalni Scuba omogućava merenje za kratko vreme pet parametara: slobodnog hlora, ukup-hlora, pH, alkalnost, brom i stabilizator (cijadna kiselina). Ako padne u vodu nema posledica pošto će plutati i nepromočiv je. Veliki ekran LCD, napajanje dve baterije (AAA), srednji kapacitet 500 merenja. Automatsko gašenje posle 5 minuta upotrebe. Sadrži i 20 pilula DPD1, 20 Phenol red, 10 DPD3, 10 cijanidne kiseline, 10 TA Photometer. Digitalni tester Scuba III omogućava merenje za kratko vreme 11 parametara: hlor (totalni, slobodni, kombinovani), brom, pH, alkalnost, tvrdoća kalcijuma, cijanidna kiselina, aktivni kiseonik, bakar i fosfat. Ekran svetleći u boji da naznači uslove sigurnosti vode, prenos podataka wireless putem NFC. Uključuje 20 pilula DPD1, 20 Phenol red, 10 DPD3, 10 cijanidne kiseline, 10 Alka-M, 10 Kalcijum-H n.1, 10 Calcio-H n.2

The digital tester Scuba detects in few minutes five parameters: free chlorine, total chlorine, pH, alkalinity, bromine and stabilizer (cyanuric acid). If it falls into the water, there will be no consequences as floating and waterproof. Large LCD display, power supply two batteries (AAA), average capacity 500 measurements. Automatic shutdown after 5 minutes of inactivity. Includes 20 pills DPD1, 20 Phenol red, 10 DPD3, 10 cyanuric acid, 10 Alka-M Photometer. The digital tester Scuba III detects in few minutes 11 parameters: chlorine (total, free, combined), bromine, pH, alkalinity, calcium hardness, cyanuric acid, active oxygen, copper, and phosphate. Backlit color display to indicate safe water conditions, wireless data transmission via NFC. Includes 20 pills DPD1, 20 Phenol red, 10 DPD3, 10 cyanuric acid, 10 Alka-M Photometer, 10 Calcium-H n.1, 10 Calcium-H n.2

Šifra/code	Opis/description	Cena/price
1055237	Tester digitalni Scuba slobodni hlor - hlor totalni - pH – cijanidna kiselina - alkalnost Digital tester Scuba II free chlorine, total chlorine, pH, alkalinity and cyanuric acid	234,50 €
1055231	Pilule dopuna za Scuba II : 20 DPD1, 10 pH, 10 DPD3, 10 cijanidna kiselina, 10 TA Scuba II pills recharge: 20 DPD1, 10 Phenol red, DPD3 10, 10 cyanuric acid, 10 TA	20,70 €
1055240	Tester digitalni Scuba III SMART sa prenosom podataka wireless Scuba III SMART digital tester with wireless data transmission	384,70 €
1055241	Pilule dopuna za Scuba III	17,20 €

FOTOMETAR DIGITALNI
DIGITAL PHOTOMETER



Il fotometar MD200 isporučuje se u kompletu sa aktovkom, reagensima dotiranim Dpd1+Dpd3+pH+Cya u tabletama u blister pakovanju zapečaćeni. Nepromočivi, pomicanje memorije, autom.gašenje, vreme i datum u realnom vremenu, modalitet kalibracije, osvetljeni ekran, funkcija memorisanja, interface IR za tranzmisiju i štampanje podataka. Precizni rezultati kroz upotrebu filtera interferencijalnih visokog kvaliteta.

The photometer MD200 is delivered complete with carrying case, reagents supplied DPD1 Dpd3 + pH Cya tablets sealed in blisters. Waterproof, memory scrolling, auto power off, clock and date in real time, calibration mode, backlit display, memory function, IR interface for transmitting and printing data. Accurate results through the use of interferential filters of high quality.

Šifra/ code	Opis/description	Cena/ price
1055060	Fotometar MD 200 3in1 cl-pH-cys / Photometer MD 200 3in1-cl pH-cys	1.040,70 €
1055061	Kiveta za fotometar čep na šraf / Cuvette for Photometer screw cap	11,50 €
1055062	Plastična paleta za muckanje / Stirrer Plastic blade	7,00 €

TROUSSE I REZERVNI DELOVI ZA KOMPLET TEST

Šifre	Opis	cena
KOMPLET ZA KONTROLU TEČNOSTI		
1055030	Test komplet HLORO-PH tečni	9,30 €
1055530	Tečni test Set hlór-PH - kutija 12 kom	83,20 €
DPD KONTROLNI JASTUČIĆI / KONTROLNI TABLETI DPD		
1055033	DPD POOLTESTER set (Cl - pH) DPD /	18,00 €
1055058	OXYGEN-PH komplet /	18,00 €
1055059	KOMBI H2O2+PHMB+PH komplet (za biguanide)	25,10 €
1055064	Komplet AF 422 cijanurična kiselina /	70,70 €
1055070	5-in-1 MULTI POOLTESTER komplet (Cl-pH-cijanurična kiselina/Stabilizator alkalnosti M/tvrdoća karbonata/Kalcijum tvrdoća)	62,00 €
1055032	Mini Hlor Tester + pH 3 sa 20 ćelija reagensa tvrda kutija	12,30 €
PH METER AD100 Prenosivi elektronski merač potopni, tačnost +/-0.1, 2 kalibracije, trajanje baterije 250 sati. Da se kalibrira nedeljno		
1055068	Elektronski AD100 kompletan sa rešenjem kalibracije	90,30 €
1055094	Kalibracija rastvora pH 4 - 20 ml /	4,70 €
1055095	Kalibracija rastvora pH 7 - 20 ml /	4,70 €
1055191	Kalibracija rastvora pH 10 - 25 ml	4,70 €
REZERVNI DELOVI /		
1055042	Zamena za trousse tečni CL-PH	2,60 €
1055531	Zamena za trousse tečni CL-PH- kutija 12 kom	23,40 €
TABLETE DPD ZA POOLTESTER		
1055057	Zamena BLISTER PACK (30 Dpd1 rapid + 30 pH rapid) /	8,60 €
1055055	Zamena BLISTER PAKOVANJA (30 Kiseonik + 30 pH) /	8,60 €
1055063	Zamena KOMBI Biguanide - 20 reagensa po tipu	15,10 €
1055052	ACID CYANURIC pilule - kutija od 100 tableta	22,80 €
1055066	Pilule HLORID - kutija od 100 tableta	45,70 €
1055053	Tablete DPD GVOŽĐE - kutija od 100 tableta	61,80 €
1055054	/ Tablete DPD TVRDOĆA - kutija od 100 tableta	40,00 €
TABLETE DPD ZA FOTOMETAR		
1055048	Tablete DPD 1 - kutija od 500 tableta	47,00 €
1055049	Tablete DPD 3 - kutija od 500 tableta	47,00 €
1055050	Tablete DPD 4 - kutija od 100 tableta	12,40 €
1055051	Tablete pH - kutija od 500 tableta	47,00 €
TABLETE DPD ZATESTER RUČNE / PILLS DPD FOR MANUAL TESTER		
1055045	Tablete DPD 1 - kutija od 500 tableta	47,00 €
1055046	DPD Tablete N°3 - Kutija od 500 tableta	47,00 €
1055047	Tablete pH - kutija od 500 tableta	47,00 €



cod.1055030



cod.1055033



cod.1055058



cod.1055068



cod.1055042



cod.1055032

HEMIJSKI PROIZVODI

HLOR / HLOR



**HLOROLONG 20 G
TABLETA 20 G**



**HLOROLONG 200 G
TABLETA 200 G**



**MAGICLOR RAPIDO
GRANULARNI HLOR**



**GRANULIRANI NESTABILIZOVANI
KALCIJUM HIPOHLORIT**



**ONLYONE
MULTIFUNKCIONALNI
HLOR**



TEČNI HLOR



**CLOROSTOP
NEUTRALIZER HLORA**

ALGICIDI



**K-3 SUPER
FUNKCIJE 3 ALGACIDA**



**CRYSTALCLEAR
NORMAL ALGACID**

FLOKULANTI / FLOCCULANTS



**SUPERFLOC
TEČNOST /**



**K-KLAR
PATRONE**



BLISTER OD 12 TABLETA

REGULATORI PH



**REDMINUS
/ GRANULAR**



**REDMINUS /
TEČNOST**



PH REDUCER KUĆNI

 USAGLAŠENO SA EU 2019/1148



**REDPLUS
GRANULAR**



**REDPLUS
TEČNOST /**

AKTIVNI KISEONIK



**OXYBLU
/ TABLETE**



**AQUATOP
POBOLJŠANA TEČNOST
SA STABILIZUJUĆIM EFEKTOM**

BROMO / BROMINE



AQUABROME
DDEZINFEKCIONO SREDSTVO
NA BAZI BROMA

ANTI-LIMESCALE / ANTI-



STOPCAL
I INHIBITOR NASLAGA KALCIJUMA



STOP-METAL
SPREČAVA FLEKE OD RĐE

TRETMANI PODRŠKE



**INSEKTICID ZA
OSE**



STOP-MUS
UKLANJANJE POVRŠINSKE PENE



ZAŠTITE LINER
MOĆNI MIKROBIOCIDNI AGENS



COVERNET
ČISTAČ PREKRIVKI



BLACK ERIOCHROME
TTESTER ZA BOJE

PREČISTAČ VODENE POVRŠINE



LINEAGEL
RASTVARA MASNE NASLAGE



K-NET
RASTVARAJU NASLAGE KALCIJUMA I MASTI

ČIŠĆENJE ZEMLJIŠTA I ZIDOVA



NETSOL EXTRA KISELINA
UKLANJANJE NASLAGA KREČNJAKA



NETSOL ALKALINE SUPER
UKLANJA MASNE NASLAGE
VISOKE KONCENTRACIJE

STABILIZATOR HLORA



**IZOCIANURIČNA
KISELINA**

ČIŠĆENJE FILTERA I CEVI



AQUAFILTRE
ČIŠĆENJE, SKIDANJE KAMENCA I
DEZINFEKCIJA

PREZIMLJAVANJE / WINTERING



SREDSTVO PROTIV ALGI I KAMENCA
ANTI-ALGAE AND ANTISCALE

MULTIFUNKCIONALNO SREDSTVO ZA DEZINFEKCIJU
MULTI-FUNCTION DISINFECTANT



OVTWIN
HLOR SA AKTIVNIM KISEONIKOM
CHLORINE WITH ACTIVE OXYGEN

SO ZA ELEKTROLIZU I ČISTO BELO™
ELECTROLYSIS SALT AND BIANCOPURO™



SALE SPECIALE IN PASTIGLIE
SPECIAL SALT TABLETS



SPECIJALNA GRANULARNA SO
SPECIAL SALT GRANULAR



ČISTO BELO™
MAGNEZIJUM SO
MAGNESIUM SALT

SPA TRETMAN PROIZVODI
SPA TREATMENT PRODUCTS



GRANULARNI KISEONIK
GRANULAR OXYGEN



ALGICID
ALGAEICIDE



BROMO TABLETE
BROMINE TABLETS



PH MINUS GRANULARE
GRANULAR PH MINUS



HLOR TABLETE
CHLORINE TABLETS



PROTIV PENE
ANTI FOAM



GEL PROTIV MASTI
DEGREASING GEL



PROTIV KAMENCA
ANTISCALE



ODMAŠĆIVAČ ZA ODRŽAVANJE
DEGREASING CLEANER FOR MAINTENANCE



ELIMINATOR KAMENCA ZA CEVI
DESCALING FOR PIPES

LINIJA LO-CHLOR

ALGICID



LO-PHOSE+
ALGICIDUMANJUJE FOSFAT

IZBELJIVAČI I FLOKULANTI



MIRACLEAR TAB
TABLETE ZA
IZBELJIVANJE



NOKDAUN
KONCENTRISANI FLOKULANT
CONCENTRATED FLOCCULANT

KONZERVACIJA VODE I TOPLOTE WATER AND HEAT CONSERVATION



Leak sealer
TAMPON TEČNOST MALIH CURENJA



AQUA BLANKET
SMANJUJE ISPARAVANJE VODE,
ODRŽAVA TOPLOTU

RASTVORI ZA FLEKE



FASTSTART-TECH
SEKVESTRANT METALA- PROTIV KAMENCA



METAL GONE
SEKVESTRANT METALA



MULTI STAIN REMOVER
UKLANJAMETALNE I ORGANSKE FLEKE



CHLOR-NIKS
REDUKTOR HLORA I BROMA

ENZIMSKA FORMULACIJA



ULTRA ZYME PRO
SMANJUJE UPOTREBU HLORA I KISELINA



TABLETE I GRANULIRANI HLOR

Šifra	Opis	KG/L	cena
CLOROLONG sporo rastvaranje - tablete 200 g			
9010001	Hlorolong tableta 200 g / Tablet 200 g	1	10,90 €
9010002	Hlorolong tableta 200 g / Tablet 200 g	5	48,30 €
9010003	Hlorolong tableta 200 g / Tablet 200 g	10	93,70 €
9010004	Hlorolong tableta 200 g / Tablet 200 g	25	232,10 €
CLOROLONG hlor - tablete 20 g			
9010006	Hlorolong tableta 20 g / Tablet 20 g	1	11,00 €
MAGICLOR brzi hlor - granulirani			
9010008	Magiclор rapido / Brzi granulirani	1	7,20 €
9010009	Magiclор rapido / Brzi granulirani	5	31,80 €
9010010	Magiclор rapido / Brzi granulirani	10	62,20 €
9010011	Magiclор rapido / Brzi granulirani	25	153,30 €
HLOR - KALCIJUM HIPOHLORIN - granulirani / HLOR - KALCIJUM HIPOHLORIN - granulirani			
9010013	HIPOHLORIN-ne stabilizovan hlor	25	260,80 €
MULTIFUNKCIONALNI HLOR - u tabletama g 200 / HLOR MULTIFUNKCIJA - u tableti g 200			
9010015	ONLYONE sredstvo za dezinfekciju, algicide, flokulante, plavljenje	1	11,00 €
9010016	ONLYONE sredstvo za dezinfekciju, algicide, flokulante, plavljenje	5	49,00 €
9010017	ONLYONE sredstvo za dezinfekciju, algicide, flokulante, plavljenje	10	95,00 €
9010018	ONLYONE sredstvo za dezinfekciju, algicid, flokulant, plavljenje	25	235,50 €
TEČNI HLOR			
9010019	Tečni hlor	20	62,30 €.
NEUTRALIZER HLORA			
9010021	CLOROSTOP obarač hlora bazena u prahu / Powder chlorine blast in the pool	5	48,80 €
9010020	CLOROSTOP tečni	25	80,00 €



cod.9010001 - 9010006



cod.9010008 - 9010011



cod.9010015 - 9010018



cod.9010019



cod.9010021

ALGICIDI



2000...



cod.9020001



cod.9020015

Šifra	Opis	cena
ALGICID 3 FUNKCIJE		
9020001	SUPER K-3 - bez pene, protiv algi - flokulant / 5	29,60 €
ALGAECIDE NORMAL / NORMALNA algicid		
9020003	CRYSTALCLEAR - 1 l	5,60 €
9020004	CRYSTALCLEAR - 5l	19,80 €
9020005	CRYSTALCLEAR - 10 l	37,20 €
9020006	CRYSTALCLEAR - 25 l	83,00 €
9020015	DRAGON protiv algi - 1 l	36,00 €

FLOKULANTI



cod.9020008

Šifra
9020009

cod.9020002

Šifre	Opis	cena
BISTRINA VODE		
9020014	SUPERFLOC - tečnost 1 l / SUPERFLOC tečnost 1 l	5,60 €
9020008	SUPERFLOC - tečnost 5 l / SUPERFLOC tečnost 5 l	14,00 €
9020007	SUPERFLOC - tečnost 20 l / SUPERFLOC tečnost 20 l	51,30 €
9020009	K-KLAR patrone 1 kg / K-KLAR kertridži 1 kg	13,90 €
9020002	Izbeljivač flokulant blister tableta 12	23,20 €

PH REGULATORI



 USAGLAŠENO SA EU
2010/1148

Šifre	Opis	cena
ZA SMANJIVANJE PH		
9030010	REDMINUS granular 1,5 kg / granula 1,5 kg	6,60 € ind.
9030011	REDMINUS granular 5 kg / granular 5 kg	18,20 € ind.
9030045	REDMINUS granular 10 kg / granulirano 10 kg	36,50 € ind.
9030012	REDMINUS granular 25 kg / granulirano 25 kg	99,90 € ind.
9030028	REDMINUS granulirana vreća 25 kg	50,00 € ind.
9030019	REDMINUS tečnost 10kg / tečnost 10kg	23,20 € ind.
9030014	REDMINUS tečnost 25kg / tečnost 25kg	48,00 € ind.
9030046	REDUCER PH kućni pH reducer 10 l	41,60 € ind.
ZA POVEĆANJE PH		
9030015	REDPLUS granular 1 kg /	7,50 €
9030016	REDPLUS granular 5 kg /	26,10 €
9030018	REDPLUS tečnost 18 l /	87,00 €



REDMINUS granulirani



REDMINUS Tečni



REDPLUS granulirani



REDPLUS Tečni

AKTIVNI KISEONIK I BROM



cod.9030021 - 903001



Šifra 9030002



cod.9030005 - 9030007

Šifre	opis	Cena
Aktivni kiseonik		
9030001	OXYBLU tablete 200 gr. 5 kg / OXYBLU tablete 200 gr - 5 kg	225,60 €
9030037	OXYBLU granular 1 kg / OXYBLU granular 1 kg /	31,10 € i
AKTIVNI TEČNI KISEONIK KOJI SE NAPAJA SA STABILIZUJUĆIM DEJSTVOM		
9030002	AQUATOP tečnost 5 l	40,00 €
BROM TABLETE OD 20 g		
9030005	AQUABROME -sredstvo za dezinfekciju na bazi broma 1kg	34,70 €
9030007	AQUABROME – sredstvo za dezinfekciju na bazi broma 5 kg	181,00 €

PROTIV KAMENCA / ANTISCALE



Šifra / code	Opis / description	Cena / price
SEKVESTRAANT PROTIV KAMENCA / ANTICALCAREOUS SEQUESTERANT		
9030020	STOPCAL inhibitor naslaga kamenca u tvrdog vodi 5 l STOPCAL inhibitor of calcium deposits in hard water 5 l	21,80 €
SEKVESTRAANT METALA / METAL SEQUESTERANT		
9030034	STOP-METAL sprečava mrlje od rđe, fiksira metalne jone da bi ograničio pojavu tamnih mrlja 1 l METAL-STOP prevents rust stains, fixed metal ions to reduce the appearance of dark spots 1 l	25,40 €
9030035	STOP-METAL sprečava le mrlje od rđe, fiksira metalne jone da bi ograničio pojavljivanje tamnih mrlja 3 l METAL-STOP prevents rust stains, fixed metal ions to reduce the appearance of dark spots 3 l	64,20 €

SPECIJALNI PROIZVODI I TRETMANI PODRŠKE / SPECIAL PRODUCTS AND SUPPORT TREATMENTS

Šifra / code	Opis / description	Cena / price
9030031	STOP-VESPE insekticid za ose 1 l / STOP-WASPS repellent for wasps 1 l	33,60 €
9030033	STOP-MOUSSE eliminiše penu na površini 1 l / STOP-MOUSSE eliminates the foam on the surface 1 l	10,80 €
ZAPTIVAČ ZA PUNE BAZENE / SEALANT FOR FULL POOLS		
1035380	Leak Sealer – Tampon tečnost malih curenja 1 l / Leak Sealer - Buffer liquid of small leaks 1 l	58,60 €
SMANJENJE MIKROORGANIZAMA ISPOD IPVC / REDUCTION OF MICROORGANISMS under THE PVC		
1050451	PROTECT LINER – Moćni mikrobiocidni agens, smanjuje širenje mikroorganizama ispod obloge 5 l PROTECT LINER - potent microbiocidal agent, decreases the proliferation of microorganisms under the coating 5 l	63,70 €
ČISTAČ PREKRIVKI / CLEANER of COVERS		
9030041	COVERNET – ProDUKT za čišćenje zimskih prekrivki i automatskih, rastvara i eliminiše prljavštine 5 l COVERNET - Cleaning product of winter and automatic cover, dissolves and removes dirt 5 l	71,80 €
TESTER BOJE / COLOUR TEST		
9020020	Crni Eriocromo T – 100 g Black Eriochromium T - 100 g	154,00 €



cod.9030031



cod.9030033



cod.1050451



cod.9030041



cod.9020020

ČISTAČ POVRŠINE VODE



Šifre	Opis	cena
9030013	LINEAGEL rastvara masne naslage sa vodovodnih linija 1 l	12,40 €
9020013	K-NET rastvara naslage kalcijuma i masti sa vodovodnih linija 1 l	14,80 €

ČIŠĆENJE ZEMLJIŠTA I ZIDOVA



Šifre	Opis/opis	Cena
9030026	NETSOL EXTRA ACID to remove limescale deposits 5 l / NETSOL EXTRA ACID to remove calcium deposits 5 l	26,10 €
9030027	NETSOL ALKALINE SUPER za uklanjanje masnih naslaga visoke koncentracije 5 l /	26,10 €

STABILIZZANTE DEL CLORO / STABILIZATOR HLORA



Stabilizator je proizvod zasnovan na izocianuričnoj kiselini koja ima svojstvo usporavanja raspadanja hlora izazvanog ultraljubičastim zracima. Stabilizacija delovanja hlora je izuzetno korisna kako bi se sprečilo rasipanje hlora tokom vrelih sati u toku dana.

Šifra/kôd	Opis/opis	Cena/cena
9010035	Izocianska kiselina	20,60 €

FILTR

ČIŠĆENJE CEVI



Šifra/kôd	Opis/opis	Cena/cena
9010022	AQUAFILTRE čistač, dekaler i sredstvo za dezinfekciju 5 l / AQUAFILTRE čistač, Deskaliranje i dezinfekcija 5 l	64,30 € incl.

ZIMNA TEČNOST



Šifre	Opis	cena
9030024	ZIMSKA TEČNOST(PROTIV ALGI I KAMENCA) REDGUARD zimska tečnost 5 l	22,00 €

MULTIFUNKCIONALNO DEZINFEKCIONO SREDSTVO



"All-in-one", hlor sa aktivnim kiseonikom. šok dezinfekcija i regulisanje 2-u-1. Višefunkcionalni hlor za produženu redovnu dezinfekciju. Obogaćen aktivnim kiseonikom za nedeljnu šok dezinfekciju. Dugoročna dezinfekcija zahvaljujući sinergiji ova dva proizvoda. Eliminise alge, poboljšava filtraciju za kristalno čistu vodu. Jedna tableta za 40 m3 vode.

Šifre	Opis	cena
9010005	Hlor sa aktivnim kiseonikom 4,5 (9 tableta)	134,40 € incl.

SET HEMIJSKIH PROIZVODA

Hemijski komplet obuhvata: 1 x 5 kg Magiclora kantU; 1 x 5 kg kantI od 200 g Hlorolonga; 1 x 5 kg Redminus kante; 1 Boca od 5 litara K-3 SUPER; 1 kutija K-KLAR patrona; 1 pakovanje od 1 kg deterdženta sa linije vode LINEAGEL

Šifre	Opis	cena
9010000	Komplet za proizvode za tretman	157,00 €



Komplet proizvoda za tretman

TRETMAN PROIZVODI SPA

Asortiman proizvoda specijalno dizajniranih za tretman i čišćenje u SPA



Šifra	Opis	KG/L	cena
9030111	Algicidi	1 l	9,40 €
9030112	Brom tablete ZA sporo rastvaranje 20 gr / Bromine tablete 20 gr	1 kg	40,80 €
9030113	PH minus granular / granulirani PH minus	1,5 kg	8,80 €
9030114	Tablete hlora za sporo rastvaranje 20 gr / Hlorne tablete 20 gr	1 kg	24,50 €
9030115	Defoamer / Antifoam	1 l	14,40 €
9030116	Gel za odmaščivanje	1 l	12,40 €
9030117	Protiv kamenca	1 l	16,30 €
9030118	Čistač za odmaščivanje za održavanje	1 l	7,60 €
9030119	Čistač kamenca za cevi	1 l	20,60 €

VREĆE SOLI ZA ELEKTROLIZU BAGS OF SALT FOR ELECTROLYSIS

Prerađena so, rekristalizovana ključala so, visoke rastvorljivosti (100%) bez taloga i stranih minerala, idealna za uređaje elektrolize (u granularnom obliku) i omekšivače (u tabletama). Izričito se preporučuje za Premio+ i Autochlor.

Refined salt, recrystallized from boiling, high solubility (100%) free of debris and foreign minerals, ideal for electrolysis plants and water softeners. Specifically recommended for Premio + and Autochlor.



cod.1075018



cod.1075019

Šifra /code	Opis /description	Cena/price
1075018	Specijalna so u tabletama – vreća od 25 kg / Special salt tablets - 25 kg bag	19,80 €
1075019	Specijalna granularna so – vreća od 25 kg / Special salt granular - 25 kg bag	18,40 €

BIANCO PURO™

Mešavina soli na bazi natrijum hlorida, magnezijuma i kalijuma za elektrolitske sisteme kao UNIKO Mg.

Salt mixture based on sodium, magnesium and potassium chloride for electrolyte systems such as UNIKO Mg.



Šifra/code	Opis/description	Cena/price
1075020	BiancoPuro – magnezijumska so kanta 25 kg BiancoPuro - magnesium salt bucket 25 kg	97,20 €
1075017	BiancoPuro – magnezijumska so vreća 25 kg BiancoPuro - magnesium salt bag 25 kg	86,00 €



Šifre	Opis	cena
	ALGICID	

9031000	Lo-Phos E+ - Algicid reduktor fosfata - 1 l	63,20 €
---------	---	---------



Šifre	Opis	Cena
	IZBELJIVAČI I FLOKULANTI	

9031001	Miraclear Tab – tableta gel izbeljivač za mesečni tretman do 60m3	20,50 €
---------	---	---------

9031002	Knockdown koncentrisani flokulant velikih performansi-1l	50,00 €
---------	--	---------

Šifra	Opis	cena
	REŠENJA ZA FLEKE	

9031003	FastStart-Tech – Sekvestrant metala- protiv kamenca- 1 l	80,00 €
---------	--	---------

9031005	Metal Gone – sekvestrant metala – 1l	
---------	--------------------------------------	--

9031004	Multi-Stain Remover – Uklanja fleke bakra, rđu, mangan, organske fleke -	62,30 €
---------	--	---------

9031006	Hlor-Niks - Reduktor hlora i broma, brzo delovanje - 500 gr	86,10 €
---------	---	---------



57,00 €



Šifre	Opis	cena
	Konzervacija vode i toplote	

1035380	Leak Sealer – Tampon tečnost za sitna curenja - 1 l	58,60 €
---------	---	---------

9031007	Aqua Blanket - Smanjuje isparavanje vode, čuva toplota - 1 l	40,10 €
---------	--	---------



Šifre	Opis	cena
	FORMULACIJA ENZIMA VISOKIH PERFORMANSI	

9031008	Ultra Zyme Pro - Smanjuje upotrebu hlora i kiseline i nagomilavanja kamenca - 1 l	43,30 €
---------	---	---------



Inovativni robot čistač

Programiran za čišćenje i automatsko usisavanje prljavštine i taloga sa poda i zidova. Upravlja se direktno sa tvog mobilnog aparata sa ličnom aplikacijom preko konekcije Bluetooth. Čisti u potpunosti rezidencijalne bazene.

Jednostavnost pristupa filteru postavljenog u gornjem delu robota

New Cleaning robot programmed to clean, automatically sucking dirt and debris from the bottom and walls. Mobile control by app, thanks to the Bluetooth connection. Cleans completely residential pools. Ease of access to the filter in the upper part of the robot.



str. 424

ROBOT MOZZO

TOP ADVANCE - TOP SUPER 3000

Easy pools kit

NADZEMNI BAZENI



11



Sadržaj

SET BAZENA RONDÒ / RONDÒ SWIMMING POOLS KIT

- 452 SET RONDÒ OTTO / RONDÒ EIGHT KIT
- 452 OPREMA BAZENI RONDÒ / FACILITIES RONDÒ SWIMMING POOLS
- 453 SET RONDÒ OKRUGLA / RONDÒ CIRCULAR KIT
- 453 SET RONDÒ OVALNI / RONDÒ OVAL KIT
- 455 LINER ZA ZAMENU RONDÒ / RONDÒ REPLACEMENTS LINER

DVRENI BAZENI / WOODEN SWIMMING POOLS

- 456 ONDA NEW
- 457 NIAGARA E LINEA
- 458 NIAGARA BABY
- 459 OPREMA ONDA NEW - NIAGARA / ACCESSORIES ONDA NEW - NIAGARA

SAMONOSEĆI BAZENI / SELF-SUPPORTING SWIMMING POOLS

- 460 BLUE STAR FAMILY 100-125
- 461 BLUE STAR LUXE 125-140
- 462 PREKRIVKE ZA BLUE STAR / COVERS FOR BLUE STAR
- 463 WHITE POOL
- 464 ACQUAMARINA POOL

OPREMA / ACCESSORIES

- 465 PRERKRIVKE I LINER / COVERS AND LINERS
- 466 STEPENICE, MOTALICE, FILCEVI / LADDERS, REELS, FELT
- 467 SKIMER, PRIRUBNICE, KRILCA, KOPICE / SKIMMER, FLANGE, FLOAPS, BASKETS
- 468 FILTERI MONOBLOK / MONOBLOCK FILTERS
- 469 SISTEM PROTIV KOMARACA / ANTI - MOSQUITO SYSTEM

NADZEMNI BAZENI - EASY POOLS KIT

BAZENI RONDÒ - RONDÒ SWIMMING POOLS



OTTO

KARAKTERISTIKE | Features

Čelična struktura
structure steel

dimenzije (m) min. 6,25 x 3,60
dimensions (m) max. 8,55 x 5

visina (m) 1,20 - 1,50 height
(m)



OKRUGLI

KARAKTERISTIKE | Features

Čelična struktura
structure steel

dimenzije (m) min. 3,5
dimensions (m) max. 8

visina (m) 1,20 - 1,50 height
(m)



OVALNI

KARAKTERISTIKE | Features

Čelična struktura
structure steel

dimenzije(m) min. 5,25 x 3,20
dimensions (m) max. 11 x 5

visina (m) 1,20 - 1,50 height
(m)

DRVENI BAZENI - WOODEN SWIMMING POOLS

disponibile anche autoportante



ONDA NEW

KARAKTERISTIKE | Features

Drvena struktura
structure wood

dimenzije (m) min. 4,34 x 3,76
dimensions (m) max. 7,27 x 3,96

visina (m) min. 1,00
height (m) max. 1,20

volumen vode (m³) min. 8,95
water volume (m³) max. 25,45

disponibile anche autoportante



NIAGARA

KARAKTERISTIKE | Features

Drvena struktura
structure wood

dimenzije (m) min. 6 x 4,19
dimensions (m) max. 12,34 x 6,34

visina (m) min. 1,13
height (m) max. 1,20

volumen vode(m³) min. 22,51
water volume (m³) max. 82,23



LINEA

KARAKTERISTIKE | Features

Drvena struktura
structure wood

dimenzije (m) min. 8 x 5
dimensions (m) max. 15,5 x 3,5

visina (m) min. 1,40
height (m) max. 1,55

volumen vode (m³) min. 42,2
water volume (m³) max. 63

OPREMA - ACCESSORIES



PREKRIVKE
covers



OPREMA
equipment



STEPENICE
ladders



FILTRI
filters

SAMOSTOJEĆI BAZENI - SELF-STANDING SWIMMING POOLS



BLUE STAR FAMILY

KARAKTERISTIKE | Features

struktura structure	Čelik steel
dimenzije (m) dimensions (m)	min. 3,8 x 2,8 max. 6,8 x 3,8
visina (m) height (m)	1,00 - 1,25



BLUE STAR LUXE

KARAKTERISTIKE | Features

struktura structure	Čelik steel
dimenzije (m) dimensions (m)	min. 7,8 x 3,80 max. 9,8 x 4,8
visina (m) height (m)	1,25 - 1,40



WHITE POOL

KARAKTERISTIKE | Features

struktura structure	Čelik steel
dimenzije (m) dimensions (m)	min. 4,90 x 3,60 max. 9,10 x 4,60
visina (m) height (m)	1,3
Volumen vode (m ³) water volume (m ³)	min.15,9 max. 40



ACQUA MARINA

KARAKTERISTIKE | Features

struktura structure	Čelik steel
dimenzije (m) dimensions (m)	min. 4,90 x 3,60 max. 7,30 x 3,60
visina (m) height (m)	1,2
volumen vode (m ³) water volume (m ³)	min.17 max. 26

MOSQUITOS BYE



SISTEM protiv komaraca
anti-mosquito system

SET BAZENA RONDÒ / RONDÒ SWIMMING POOLS KIT

Ukopani bazeni Rondò imaju jaku i otpornu strukturu sa zidom od pocinkovanog čelika, presvučena poliesterom spolja i zaštitno lakiran iznutra, sa tretmanom protiv rđe. Zahvaljujući ekstremnoj lakoći instaliranja, moguće je realizovati ukopani bazen bez potrebe za traženje specijalizovanog osoblja. Komponente struktur povezane su međusobno profilima urađenim od specijalnih materijala, koji daju posebnu otpornost i čvrstoću. Obloga je od PVC lajnera, podvrgnuta tretmanu protiv UV i protiv algi..

Rondò ground pools are made of a sturdy and durable steel, coated with polyester on the outside and inside protective lacquer, with corrosion resistant treatment. Thanks to the extreme simplicity of installation, it is possible to realize a inground pool without the need to resort to specialized personnel. The components of the structure are connected together with profiles, produced with special materials, which give a particular strength and stiffness. PVC liner, treated anti UV and algae.

Set RONDÒ' OBUHVATA

- Čelična struktura tretirana protiv korozije, sa profilima za montažu
- Unutrašnja obloga liner PVC tretirano protiv UV i algi, boja svetlo plava ili pesak (debljina 0,6mm)
- Grupa za filtraciju sastavljena od peščanog filtera (pesak uključen) sa električnim ventilom 6 smernim i pumpa sa filterom.
- Skimer i odvodna mlaznica za povezivanje Na system filtracije
- Set spojki za povezivanje opreme
- Stepenice od čelika inox
- Komplet za čišćenje u sastavu jedne površinske mrežice, zidnog prodora, usisivača dna, plutajuće cevi, teleskopske drške, termometar i komplet testera za hlor.

RONDÒ' KIT INCLUDES

- Steel structure treated against corrosion, profiles for mounting
- Liner in line of PVC treated UV and algae, color sky blue and sand (thickness 0,6mm)
- Filtration group composed of the sand filter (sand inclusa) with selector valve streets and pump with prefilter
- Skimmer, the air blower and cockpit the bottom for connection to the filtration system
- Kit of connection fittings plant
- Ladder stainless steel
- Cleaning Kit consists of screen surface, brush wall, aspirafondo, float tube, telescopic handle, thermometer and chlorine test kit



Čelična struktura



Liner od PVC



Grupa za filtraciju



Skimer



Komplet za čišćenje

OPCIONALNA OPREMA

- Mašinski prostor uzemni Big Mac za filtracionu grupu
- Robot automatski čistač za čišćenje dna i zidova

OPTIONAL ACCESSORIES

- Big Mac technical housing for filter and pump
- Robot automatic cleaner for cleaning the swimming pool walls and floor



Big Mac



Robot Falcon

SET RONDÒ OTTO / RONDÒ EIGHT KIT

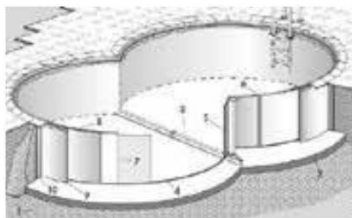

Sa olakšanim kačenjem
with easy hooking

Model	Dimenzije/dimensions [m]		visina / height [m]	PVC LINER 0,6 mm SVETLO PLAVI		PVC LINER 0,6 mm PESAK/SAND	
	Svetlo plavo	pesak/sand		šifra/ Code	cena/Price	šifra/ Code	cena/Price
Set Rondò otto 625	6,25x3,60	6,25x3,60	1,20	7200173	5.662,00 €	7200469	6.000,00 €
Set Rondò otto 725	7,25x4,60	7,25x4,60	1,20	7200174	6.629,00 €	7200470	7.069,00 €
Set Rondò otto 855	8,55x5,00	8,55x5,00	1,20	7200175	7.631,00 €	7200471	7.909,00 €
Set Rondò otto 725	7,25x4,60	7,25x4,60	1,50	7200179	7.786,00 €	7200496	7.768,00 €
Set Rondò otto 855	8,55x5,00	8,55x5,00	1,50	7200180	8.745,00 €	7200497	8.974,00 €

SET RONDÒ OKRUGLA / RONDÒ CIRCULAR KIT

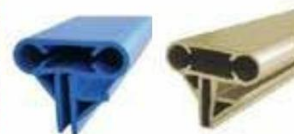
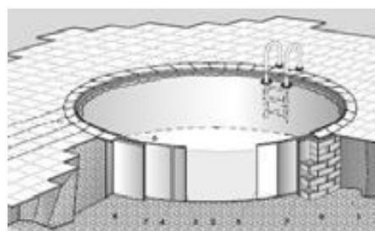
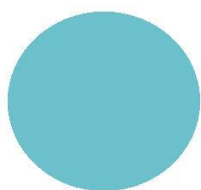

Sa olakšanim kačenjem
with easy hooking

Model/model	Dimenzije/dimensions [m]		Visina/ height [m]	PVC LINER 0,6 mm SVETLO PLAVA		PVC LINER 0,6 mm PESAK/ SAND	
	Svetlo plava	Pesak/sand		Šifra/ Code	Cena/Price	Šifra/ Code	Cena/Price
Set Rondò okrugla 400	ø4,20	ø4,16	1,20	7200120	3.347,00 €	7200251	3.477,00 €
Set Rondò okrugla 500	ø5,00	ø5,00	1,20	7200145	3.887,00 €	7200252	4.078,00 €
Set Rondò okrugla 600	ø6,00	ø6,00	1,20	7200146	4.595,00 €	7200253	4.831,00 €
Set Rondò okrugla 700	ø7,00	ø7,00	1,20	7200147	5.237,00 €	7200254	5.518,00 €
Set Rondò okrugla 800	ø8,00	ø8,00	1,20	7200148	5.976,00 €	7200255	6.361,00 €
Set Rondò okrugla 600	ø6,00	ø6,00	1,50	7200153	5.328,00 €	7200256	5.587,00 €
Set Rondò okrugla 700	ø7,00	ø7,00	1,50	7200154	6.046,00 €	7200257	6.388,00 €

KIT RONDÒ OVALNI / RONDÒ OVAL KIT

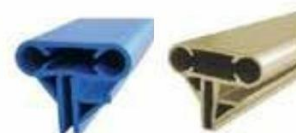
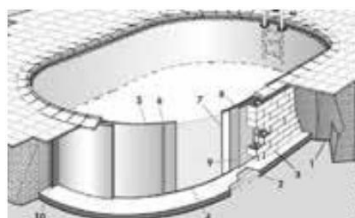

Sa olakšanim kačenjem
with easy hooking

Model/model	Dimenzije/dimensions [m]		visina/ height [m]	PVC LINER 0,6 mm SVETLO PLAVO		PVC LINER 0,6 mm Pesak/ SAND	
	Svetlo plava/light	Pesak/sand		šifra/ Code	Cena/Price	Šifra/ Code	Cena/Price
Kit Rondò ovalna 525	5,25x3,20	5,25x3,20	1,20	7200158	3.824,00 €	7200458	3.951,00 €
Kit Rondò ovalna 600	6,00x3,20	6,00x3,20	1,20	7200159	4.218,00 €	7200459	4.360,00 €
Kit Rondò ovalna 700	7,00x3,50	7,00x3,60	1,20	7200160	4.661,00 €	7200460	4.852,00 €
Kit Rondò ovalna 800	8,00x4,20	8,00x4,16	1,20	7200161	5.301,00 €	7200461	5.519,00 €
Kit Rondò oval 1000	10,00x4,16	10,00x4,16	1,20	7200163	6.275,00 €	7200462	6.491,00 €
Kit Rondò oval 1100	11,00x5,00	11,00x5,00	1,20	7200164	7.320,00 €	7200463	7.838,00 €
Kit Rondò ovalna 600	6,00x3,20	6,00x3,20	1,50	7200166	4.793,00 €	7200464	4.889,00 €
Kit Rondò ovalna 700	7,00x3,50	7,00x3,60	1,50	7200167	5.615,00 €	7200465	5.709,00 €
Kit Rondò ovalna 800	8,00x4,20	8,00x4,16	1,50	7200168	6.276,00 €	7200466	6.502,00 €
Kit Rondò ovaln 1000	10,00x4,16	10,00x4,16	1,50	7200170	7.805,00 €	7200467	7.817,00 €
Kit Rondò oval 1100	11,00x5,00	11,00x5,00	1,50	7200171	8.630,00 €	7200468	9.298,00 €

MONTAŽA BAZENA THE POOL ASSEMBLY

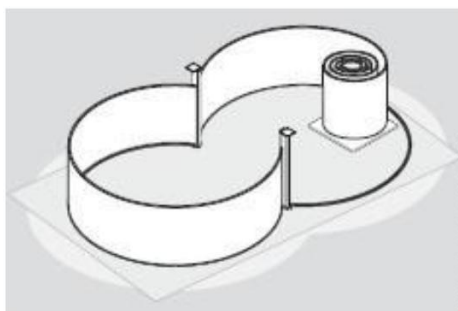

Montaža bazena je jednostavna i može se sažeti u sledeće korake:

- Trasiranje osega bazena
- Smeštaj noseće konstrukcije
- Montiranje greda i nosača
- Instalacija noseće konstrukcije
- Polaganje pozadinske cerade
- Polaganje baznog profila
- Montaža lima
- Spajanje krajeva lima
- Polaganje obloge (liner)
- Postavljanje rukohvata
- Ispuna bazena
- Zidna ispuna

The mounting of the pool is simple and can be summarized in the following steps:

- Trace the perimeter of the tank
- Housing for the backbone
- Assembly of the beams and supports
- Installation of the supporting framework
- Laying of the cloth background
- Installation of basic profile
- Installation of sheet metal
- Conjunction of the ends of the sheet
- Laying of the coating (liner)
- Installation of handrails
- Filling the tank
- Filling the wall

Ovalni bazen inače mora biti montiran na armiranoj betonskoj ploči debljine cca 15 cm. Na stranicama bazena, duž vertikalnih ravnih zidova, mora se izgraditi jedan potporni zid, koji će garantovati efikasnu podlogu strukturnoj otpornosti protiv potisne sile vode.

The oval pool must also be mounted on a slab made of reinforced concrete, with a thickness of about 15 cm. At the sides of the swimming pool, along the straight walls, must be made of a wall support, which ensures an effective support to the resistance of the structure against the thrust force of the water.

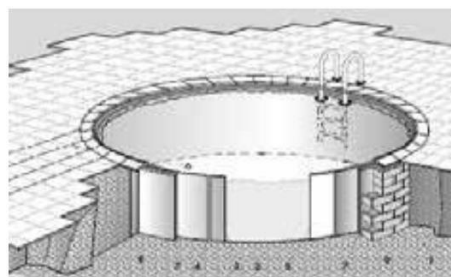
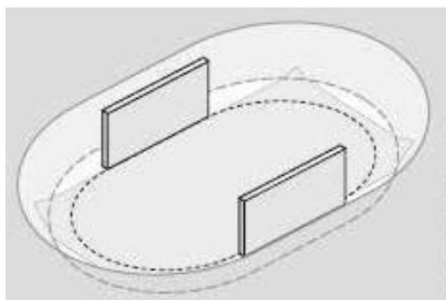

Rondò OKRUGLA

1. Teren
2. Donja vođica
3. Limovi
4. Profil za kaćenje
5. Liner
6. Rukohvat
7. Izolacija
8. Beton
9. Zidarski rad

Rondò circular

1. Ground
2. Lower guide
3. Sheet
4. Hocking profile
5. Liner
6. Handrail
7. Insulation
8. Concrete
9. Masonry

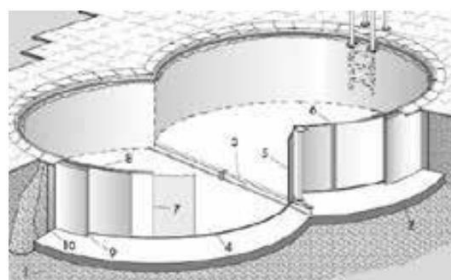

Rondò Otto

1. Teren
2. Ploča (armirana)
3. Noseći kostur
4. Donja vođica
5. Limovi
6. Profil za kaćenje
7. Liner
8. Rukohvat
9. Izolacija
10. Beton

Rondò eight

1. Ground
2. Slab (armed)
3. Backbone
4. Lower guide
5. Sheet
6. Hocking profile
7. Liner
8. Handrail
9. Insulation
10. Concrete

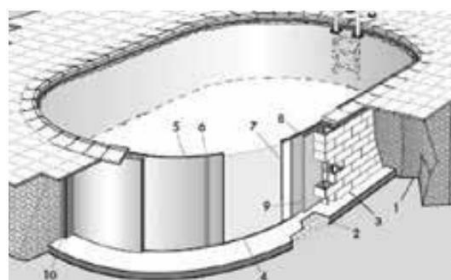

Rondò Ovalna

1. Teren
2. Ploča (armirana)
3. Zid (armirani)
4. Donja vođica
5. Limovi
6. Profil za kaćenje
7. Liner
8. Rukohvat
9. Izolacija
10. Beton

Rondò oval

1. Ground
2. Slab (armed)
3. Wall (concrete)
4. Lower guide
5. Sheet
6. Hocking profile
7. Liner
8. Handrail
9. Insulation
10. Concrete

BAZENI RONDÒ – REZERVNI LAJNER DEBLJINE 60/100*
RONDÒ SWIMMING POOLS - REPLACEMENTS LINER THICKNESS 60/100*



BAZEN RONDÒ OTTO / EIGHT ROUND POOL
 Liner rezervni / *Liner replacements*

Dimenzije/Dimensions	Šifra sv.plava/code light blue	Cena/price	Šifra pesak/code sable	Cena/price
Rondò otto 625 / H. 120 cm	7200400	1.327,20 €	7200500	1.474,20 €
Rondò otto 725 / H. 120 cm	7200418	1.667,40 €	7200501	1.852,20 €
Rondò otto 855 / H. 120 cm	7200420	1.995,00 €	7200474	2.205,00 €
Rondò otto 725 / H. 150 cm	7200422	1.734,60 €	7200475	1.890,00 €
Rondò otto 855 / H. 150 cm	7200424	2.121,00 €	7200476	2.335,20 €



BAZEN RONDÒ OKRUGLA / EIGHT ROUND POOL
 Liner rezervni / *Liner replacements*

Dimenzije/Dimensions	Šifra sv.plava/code light blue	Cena/price	Šifra pesak/code sable	Cena/price
Rondò okrugla 350 /H. 120 cm	7200401	823,20 €	7200477	898,80 €
Rondò okrugla 400 /H. 120 cm	7200403	932,40 €	7200478	1.050,00 €
Rondò okrugla 500 /H. 120 cm	7200405	1.260,00 €	7200479	1.419,60 €
Rondò okrugla 600 /H. 120 cm	7200407	1.638,00 €	7200480	1.856,40 €
Rondò okrugla 700 /H. 120 cm	7200409	2.011,80 €	7200481	2.238,60 €
Rondò okrugla 800 /H. 120 cm	7200411	2.402,40 €	7200482	2.704,80 €
Rondò okrugla 600 /H. 150 cm	7200413	1.743,00 €	7200483	1.961,40 €
Rondò okrugla 700 /H. 150 cm	7200415	2.112,40 €	7200484	2.352,00 €



BAZEN RONDÒ OVALNA / EIGHT OVAL POOL
 Rezervni lajner / *Liner replacements*

Mere/Dimensions	Pifra sv.plava/code light blue	Cena/price	Šifra pesak/code sand	Cena/price
Rondò ovalni 525 /H. 120 cm	7200426	924,00 €	7200485	1.012,20 €
Rondò ovalni 600 /H. 120 cm	7200428	1.045,80 €	7200486	1.134,00 €
Rondò ovalni 700 /H. 120 cm	7200430	1.247,40 €	7200487	1.356,60 €
Rondò ovalni 800 /H. 120 cm	7200432	1.558,20 €	7200488	1.680,00 €
Rondò ovalni 1000 /H. 120 cm	7200434	1.944,60 €	7200489	2.121,00 €
Rondò ovalni 1100 /H. 120 cm	7200436	2.503,20 €	7200490	2.688,00 €
Rondò ovalni 600 /H. 150 cm	7200438	1.188,60 €	7200491	1.289,40 €
Rondò ovalni 700 /H. 150 cm	7200440	1.369,20 €	7200492	1.495,20 €
Rondò ovalni 800 /H. 150 cm	7200442	1.692,60 €	7200493	1.843,80 €
Rondò ovalni 1000 /H. 150 cm	7200444	2.091,60 €	7200494	2.263,80 €
Rondò ovalni 1100 /H. 150 cm	7200446	2.646,00 €	7200495	2.885,40 €

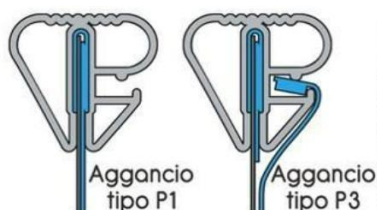

U FAZI NARUDŽBE MOLIMO SPECIFICIRATI TIP TRAŽENOG KAČENJA
WHEN ORDERING PLEASE SPECIFY THE TYPE OF COUPLING REQUIRED

* Rezervni lajner isključivo za bazene Rondò kupljene od 2018. Za prethodne modele tražiti šifre i cene.
 * Replacement liners exclusively for Rondò pools purchased from 2018. For previous models request codes and prices.

ONDA NEW-DRVENI BAZENI



- Struktura od nordijskog drveta
- Debljina zida 4,5 cm
- Širina ivice 29,5 cm
- Impregnacija drveta u autoklavi klase IV, omogućava dugotrajnu zaštitu protiv parasite i nevremena

- Nordic wood structure
- Wall thickness 4,5 cm
- Width of edge 29.5 cm
- Pretreatment of wood in an autoclave class IV, ensures long-lasting protection against pests and weather

UKLJUČENO U KOMPLETU

- Liner 60/100 svetlo plavi ili pesak, tretirano protiv UV
- Prostirka za dno od sigurnosnog protiv bakterijskog filca
- Grupa monoblok sa peščanim filterom i pumpom.
- Spoljne stepenice od drveta
- Stepenice za ulazak u vodu od čelika
- Komplet za održavanje (usisna metla, površinska mrežica, teleskopska drška, plutajuća cev, trousse analiza vode)

INCLUDED IN KIT

- Blue or sand liner thickness 60/100, UV resistant
- Bottom pad with felt
- Sand filter system with pump
- External wood staircase
- Scale for internal access
- Maintenance Kit (vacuum head, surface net, telescopic handle, floating hose, kit water analysis)

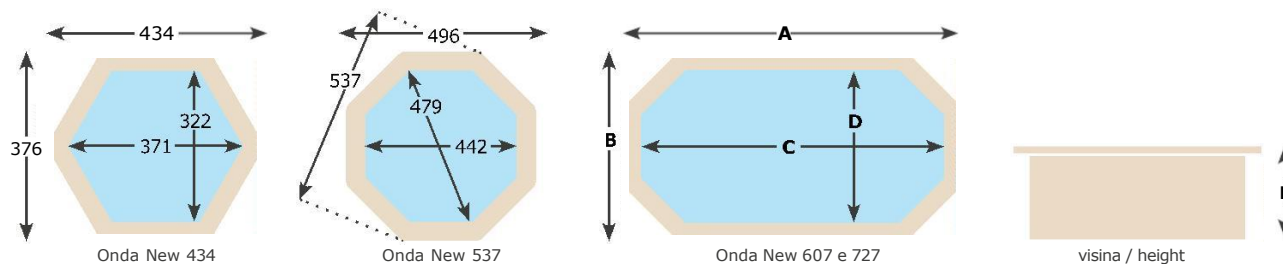

Šifra sa svetlo plavim lajnerom / Code with light blue liner	Šifra sa lajnerom peska / Code with sand liner	Model / model	Dim. spoljne / Ext. dimensions A x B x H [cm]	Dim. Unutrašnje / Int. dimensions C x D x Hint [cm]	Dubina vode / Depth water [m]	Volumen vode / Water volume [m ³]	Cena sa svetlo plavim lajnerom / Price with light blue liner	Cena sa lajnerom pesak / Price with sand liner
8030030	8030018	Onda New 434 / Onda New pool 434	434 x 376 x 116	371 x 322 x 113	1,00	8,95	5.073,00 €	5.209,00 €
8030031	8030017	Onda New 537 / Onda New pool 537	537 x 496 x 118	479 x 442 x 113	1,00	16,21	6.513,00 €	6.674,00 €
8030032	8030019	Onda New 607 / Onda New pool 607	607 x 396 x 131	553 x 342 x 126	1,13	19,33	8.471,00 €	8.647,00 €
8030033	8030020	Onda New 727 / Onda New pool 7	727 x 396 x 138	673 x 342 x 133	1,20	25,45	10.119,00 €	10.317,00 €

ONDA NEW – MODELI SAMOSTOJEĆI / SELF-SUPPORTING MODELS

Bazeni Onda New sa sistemom za direktnu instalaciju na stabilizovanom zemljištu bez potrebe pravljena betonskog temelja. Visina samonosećeg kompleta 12 cm.

Onda New Swimming Pool with system for direct installation on stabilized ground without the need for concrete basement installations. Self-supporting kit height 12 cm.

Šifra sa svetlo plavim lajnerom / Code with light blue liner	Šifra sa lajnerom pesak / Code with sand liner	Model/ model	Spoljne dimezije / Ext. dimensions A x B x H [cm]	Unutrašnje dimezije / Int. dimensions C x D x Hint [cm]	Dubina vode / Depth water [m]	Volume n vode Water volume [m ³]	Cena sa svetlo plavim lajnerom / Price with light blue liner	Cena sa lajnerom pesak/ Price with sand liner
8030120	8030121	Onda Samostojeći 607 / Self-supporting	607 x 396 x 131	553 x 342 x 126	1,13	19,33	10.207,00 €	10.383,00 €
8030122	8030123	Onda Samostojeći 727 /	727 x 396 x 138	673 x 342 x 133	1,20	25,45	12.711,00 €	12.909,00 €

NIAGARA I LINEA PRAVUGAONI



NIAGARA



LINEA

- Struktura u nordijskom drvetu
- Debljina zida 4,5 cm
- Impregnacija drveta u autoklavi klasa IV, obezbeđuje dugotrajnu zaštitu protiv parazita i nevrete.

KOMPLET PODRAZUMEVA

- Lajner 60/100 sv.plavi ili pesak, tretiran protiv UV
- Prostirka dna od sigurnosnog filca protiv bakterija
- Grupa monoblok sa peščanim filterom i pumpom
- Spoljne stepenice od drveta
- Stepenice za ulazak u vodu od čelika
- Set za odžavanje (usisna metla, mrežica za površinu, teleskopska držka, plutajuća cev, trousse za anlizu vode)

- Nordic wood structure
- Wall thickness 4,5 cm
- Pretreatment of wood in an autoclave class IV, ensures long-lasting protection against pests and weather

INCLUDED IN KIT

- Blue or sand liner thickness 60/100, UV resistant
- Bottom pad with felt
- Sand filter system with pump
- External wood staircase
- Scale for internal access
- Maintenance Kit (vacuum head, surface net, telescopic handle, floating hose, kit water analysis)

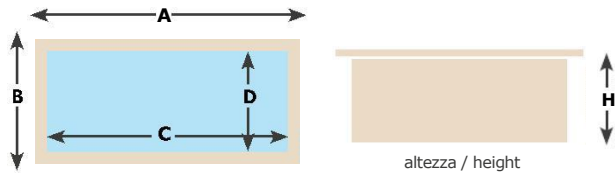

Šifra Sa svetlo plavim lajnerom / Code with light blue liner	Šifra Liner pesak / Code with sand liner	Model NIAGARA / model NIAGARA	Dim. spoljna / Ext. dimensions A x B x H [cm]	Dim. Unutrašnja / Int. dimensions C x D x Hint [cm]	Dubina vode / Depth water [m]	Volumen vode / Water volume [m3]	Cena sa linerom / Svetlo plava / Price with light blue liner	Cena sa linerom pesak / Price with sand liner
8030037	8030021	Niagara pravougaon 600 / Niagara pool rectangular 600	600 x 419 x 131	546 x 365 x 126	1,13	22,51	11.271,00 €	11.356,00 €
8030038	8030022	Niagara pravougaona 834 / Niagara pool rectangular 834	834 x 492 x 138	780 x 438 x 133	1,20	40,99	15.618,00 €	15.749,00 €

Šifra / Code	Model LINEA / model LINEA	Spoljne dimenzije/ Ext. dimensions A x B [cm]	Spoljna visina ext. height H [cm]	Dim.unutraš nje int. dimen- sions C x D [cm]	Volumen vode/ Water volume [m3]	Površina swimming area [m2]	Cena / Price
8040103	Bazen Linea pravougaoni 800x500 Rectangular pool Linea 800x500	800 x 500	140	750 x 450	42,2	33,80	19.334,00 €
8040101	Bazen Linea pravougaoni 1100x500 Rectangular pool Linea 1100x500	1100 x 500	140	1050 x 450	66,2	47,30	24.674,00 €
8040102	Bazen Linea pravougaoni 1550x350 Rectangular pool Linea 1550x350	1550 x 350	155	1500 x 300	63	45,00	28.911,00 €

NIAGARA – MODELI SAMONOSEĆI / SELF-SUPPORTING MODEL

Bazeni NIAGARA sa sistemom za direktnu instalaciju na stabilizovanom terenu bez potrebe gradnje betonskog temelja. Visina samonosećeg kompleta 12 cm

NIAGARA Swimming Pool with system for direct installation on stabilized ground without the need for concrete basement installations. Self-supporting kit height 12 cm.

Šifra sa liner Sv.plava /	Šifra sa liner pesak	Model NIAGARA	Dim. spoljna/ Ext. dimensions A x B x H [cm]	Unutrašnja dimenzija/ Int. dimensions C x D x Hint [cm]	Dubina vode / Depth water [m]	Volumen vode / Water volume [m3]	Cena sa lajnerom / Sv.plava/ Price with light blue liner	Cena sa lajnerom pesak / Price with sand liner
8030124	8030125	Niagara samonoseći 600 / Self supporting Niagara	600 x 419 x 131	546 x 365 x 126	1,13	22,51	15.511,00 €	15.688,00 €
8030126	8030127	Niagara samonoseći 834 /	834 x 492 x 138	780 x 438 x 133	1,20	40,99	23.841,00 €	24.174,00 €



- Struktura od drveta
- Debljina stranica 4,5 cm
- Širina ivice 17 cm
- Prethodna obrada drveta u autoklavi klase IV, omogućava dugotrajnu zaštitu od parazita i nevremena

- Wooden structure
- Wall thickness 4.5 cm
- Edge width 17 cm
- Pre-treatment of wood in class IV autoclave, provides long-lasting protection against pests and weathering

OBUHVAĆENO KOMPLETOM

- Liner 60/100 plavi
- Prostirka poda
- Peščani filter: 4,5 m³/h
- 1 skimer
- 1 mlaznica

INCLUDED IN KIT

- Liner 60/100 light blue
- Bottom mat
- Sand filter: 4.5 m³/h
- 1 skimmer
- 1 return fitting

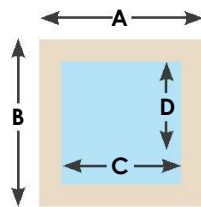

Šifra / Code	Model / model	Dim. spoljne / Ext. dimensions A x B x H [cm]	Dim. Unutrašnje / Int. dimensions C x D x H int [cm]	Zapremina vode / Water volume [m ³]	Cena / Price
8030085	Niagara baby	210x210x78	181x181x78	2,6	2.425,00 €

OPREMA ONDA NEW - NIAGARA / ACCESSORIES ONDA NEW - NIAGARA

**SUNČANA PREKRIVKA**

Sunčana prekrivka od polietilena sa saćem termičkog efekta radi održavanja temperature vode i izbegavanja isparavanja, težine od cca 165 g/m². Štiti od zagađivanja i prljavštine, smanjuje potrošnju hemijskih preparata i tretmana vode.

ZIMSKA PREKRIVKA

Zimska prekrivka od poliestera od 90 g/m². Štiti vodu od od spoljnih prljavština. Preporučuje se korišćenje kao zaštitna prekrivka.

LINER za unutrašnju oblogu, debljine 60/100.

SOLAR COVER

Solar cover made of polyethylene with alveoli for thermal effect to maintain the temperature of the water and prevent evaporation, about 165 g/m². Protects from dirt and pollution, reduces the consumption of chemicals and treatment.

WINTER COVER

Winter cover PS 90 g/m². Protects the water from the dirt from outside. Recommended for winter as a hedge of protection.

LINER thickness 60/100.

Šifra/code	Opis/description	Cena/price
SOLARNA PREKRIVKA / SOLAR COVER		
8020200	Prekrivka sa mehurićima bazen Onda New 434 / Bubble cover for Onda 434	80,70 €
8020201	Prekrivka sa mehurićima bazen Onda New 537 / Bubble cover for Onda 537	119,40 €
8020203	Prekrivka sa mehurićima bazen Onda New 607 / Bubble cover for Onda 607	167,20 €
8020204	Prekrivka sa mehurićima bazen Onda New 727 / Bubble cover for Onda 727	227,90 €
8020240	Prekrivka sa mehurićima bazen Niagara 600 / Bubble cover for Niagara 600	137,70 €
8020241	Prekrivka sa mehurićima bazen Niagara 834 / Bubble cover for Niagara 834	185,10 €
ZIMSKA PREKRIVKA / WINTER COVER		
8020207	Zimska prekrivka bazen Onda New 434 / Winter cover for Onda 434	87,10 €
8020208	Zimska prekrivka bazen Onda New 537 / Winter cover for Onda 537	115,20 €
8020209	Zimska prekrivka bazen Onda New 607 / Winter cover for Onda 607	100,10 €
8020210	Zimska prekrivka bazen Onda New 727 / Winter cover for Onda 727	113,20 €
8020248	Zimska prekrivka bazen Niagara 600 / Winter cover for Niagara 600	259,00 €
8020249	Zimska prekrivka bazen Niagara 834 / Winter cover for Niagara 834	410,00 €
LINER/ LINER		
8020220	Liner plavi bazena Onda New 434 / Pool liner blue Onda New 434	619,00 €
8020221	Liner plavi bazena Onda New 537 / Pool liner blue Onda New 537	882,90 €
8020222	Liner plavi bazena Onda New 607 / Pool liner blue Onda New 607	918,90 €
8020223	Liner plavi bazena Onda New 727 / Pool liner blue Onda New 727	1.107,30 €
8020231	Liner plavi bazena Niagara 600 / Pool liner blue Niagara 600	1.251,60 €
8020232	Liner plavi bazena Niagara 834 / Pool liner blue Niagara 834	1.941,40 €
8020226	Liner pesak bazena Onda New 434 / Pool liner sand Onda New 434	807,10 €
8020227	Liner pesak bazena Onda New 537 / Pool liner sand Onda New 537	1.071,10 €
8020228	Liner pesak bazena Onda New 607 / Pool liner sand Onda New 607	1.124,10 €
8020229	Liner pesak bazena Onda New 727 / Pool liner sand Onda New 727	1.337,70 €
8020233	Liner pesak bazena Niagara 600 / Pool liner sand Niagara 600	1.415,70 €
8020234	Liner pesak bazena Niagara 834 / Pool liner sand Niagara 834	2.191,70 €
MAŠINSKI PROSTOR OD DRVETA / WOOD TECHNICAL HOUSING		
8020224	Mašinski prostor od drveta 1,15x0,79x1,16 bez poda / Wood technical housing without bottom 1,15x0,79x1,16	408,00 €

BLUE STAR FAMILY 100-125



Nadzemni bazeni sa nosećom čeličnom galvaniziranom strukturom.

Opremljene sistemom filtracije i čišćenja.

Na raspolaganju dve dubine:

h 100 cm

h 125 cm

OBUHVAĆENO KOMPLETOM

- Platno od tkanine obostrano premazanog PVC tretiran protiv buđi, antihlor i stabilizovan UV + čelični cevni nosači
- Skimer + usisna mlaznica
- Filtrirajući sklop
- Set fittinga i cevi
- Set za čišćenje u sastavu plutajuće cevi, usisivač blata, teleskopska ručka 1,20x2,40
- Čelične stepenice
- Set za održavanje: Hlorolong od 1 kg i Crystalclear od 1 lt

Above ground swimming pool with frame in galvanized steel.

Complete of filtration system and cleaning.

Available in two depths:

H 100 cm

H 125 cm

INCLUDED IN KIT

- Pool in fabric coated on both sides PVC mildewresistant, anti-chlorine and UV stabilized + posts
- Skimmer + nozzle inlet
- Cartridge filter or filter+pump HAVANA
- Kit of fittings and pipes
- Cleaning kit consists of a float tube, a vacuum point, a telescopic handle 1,20 x2, 40
- Steel ladder
- Maintenance kit: Clorolong 1 kg and Crystalclear 1 lt

Šifra/ code	Model/model	Filter/filter	dimenzije/ dimensions	Gabarit Na tlu/ footprint	Visina [m]	Cena/price
8051100	Bazen Blue-star Family h 100 - 3,80x2,80	pesak	3x2	3,80x2,80	1	2.680,00 €
8051116	Bazen Blue-star Family h 100 - 4,80x2,80	pesak	4x2	4,80x2,80	1	3.147,00 €
8051102	Bazen Blue-star Family h 100 - 4,80x3,80	pesak	4x3	4,80x3,80	1	3.447,00 €
8051103	Bazen Blue-star Family h 100 - 5,30x2,80	pesak	4,5x2	5,30x2,80	1	3.242,00 €
8051104	Bazen Blue-star Family h 100 - 5,80x2,80	pesak	5x2	5,80x2,80	1	3.338,00 €
8051105	Bazen Blue-star Family h 100 - 6,30x3,30	pesak	5,5x2,5	6,30x3,30	1	3.879,00 €
8051106	Bazen Blue-star Family h 100 - 5,80x3,80	pesak	5x3	5,80x3,80	1	3.815,00 €
8051107	bazen Blue-star Family h 100 - 6,80x3,80	pesak	6x3	6,80x3,80	1	4.288,00 €
8051108	Bazaen Blue-star Family h 125 - 3,80x2,80	pesak	3x2	3,80x2,80	1,25	2.880,00 €
8051117	Bazen Blue-star Family h 125 - 4,80x2,80	pesak	4x2	4,80x2,80	1,25	3.355,00 €
8051110	Bazen Blue-star Family h 125 - 4,80x3,80	pesak	4x3	4,80x3,80	1,25	3.674,00 €
8051111	Bazen Blue-star Family h 125 - 5,30x2,80	pesak	4,5x2	5,30x2,80	1,25	3.476,00 €
8051112	BazenBlue-star Family h 125 - 5,80x2,80	pesak	5x2	5,80x2,80	1,25	3.566,00 €
8051113	Bazen Blue-star Family h 125 - 6,30x3,30	pesak	5,5x2,5	6,30x3,30	1,25	4.234,00 €
8051114	Bazen Blue-star Family h 125 - 5,80x3,80	pesak	5x3	5,80x3,80	1,25	4.067,00 €
8051115	Bazen Blue-star Family h 125 - 6,80x3,80	pesak	6x3	6,80x3,80	1,25	4.564,00 €

BLUE STAR LUXE 125-140



Le immagini hanno puro scopo illustrativo
The images have illustration purposes only



Struktura sa ojačanjem boje standard BELO
Frame with reinforcement, standard color WHITE

Nadzemni bazeni sa galvaniziranom nosećom strukturom sa ojačanjem.
Opremljen sistemom filtracije i čišćenja.

Na raspolaganju dve dubine:

h 125 cm

h 140 cm

OBUHVAĆEN KOMPLETOM

- Platno od tkanine obostrano premazanog PVC tretiran protiv buđi, antihlor i stabilizovan UV + čelični cevni nosači
- Skimer + usisna mlaznica
- Filtrirajući sklop HAVANA
- Komplet fittinga i cevi
- Set za čišćenje u sastavu plutajuće cevi, usisivača poda, teleskopske ručke 1,20x2,40
- Čelične stepenice inox 1,32 o 1,40 sa platformom
- Set za održavanje: Hlorolong od 1 kg i Crystalclear od 1 lt.

Above ground swimming pool with frame in galvanized steel with reinforcement. Complete of filtration system and cleaning.

Available in two depths:

H 125 cm

H 140 cm

INCLUDED IN KIT

- Pool in fabric coated on both sides PVC mildewresistant,
- Anti-chlorine and UV stabilized + posts
- Skimmer + nozzle inlet
- Filter + pump HAVANA
- Kit of fittings and pipes
- Cleaning kit consists of a float tube, a vacuum point, a telescopic handle 1,20 x2, 40
- Steel ladder 1.32 or 1,40 with platform
- Maintenance kit: Clorolong 1 kg and Crystalclear 1 lt

Šifra/code	Model/model	Filter/filter	Površina vode/ unutrašnje dimenzije	Gabarit na a tlu/ footprint	Visina [m]	Cena/price
8051151	Bazen Blue-star Luxe h 125 - 7,80x3,80	pesak	7x3	7,80x3,80	1,25	5.707,00 €
8051152	Bazen Blue-star Luxe h 125 - 7,80x4,80	pesak	7x4	7,80x4,80	1,25	6.521,00 €
8051153	Bazen Blue-star Luxe h 125 - 8,80x3,80	pesak	8x3	8,80x3,80	1,25	6.190,00 €
8051154	Bazen Blue-star Luxe h 125 - 9,80x3,80	pesak	9x3	9,80x3,80	1,25	6.970,00 €
8051155	Bazen Blue-star Luxe h 125 - 9,80x4,80	pesak	9x4	9,80x4,80	1,25	8.964,00 €
8051156	Bazen Blue-star Luxe h 140 - 6,80x3,80	pesak	6x3	6,80x3,80	1,4	5.653,00 €
8051157	Bazen Blue-star Luxe h 140 - 7,80x3,80	pesak	7x3	7,80x3,80	1,4	6.277,00 €
8051159	Bazen Blue-star Luxe h 140 - 8,80x3,80	pesak	8x3	8,80x3,80	1,4	7.913,00 €
8051161	Bazen Blue-star Luxe h 140 - 9,80x4,80	pesak	9x4	9,80x4,80	1,4	12.007,00 €

PREKRIVKE ZA BLUE STAR / COVERS FOR BLUE STAR

PREKRIVKA 4 GODIŠNJA DOBA

Zelena platno sa ušicama i elastičnim užetom štiti bazen u kojem god periodu godine od svake vrste spoljnog uticaja. Prošiveno na sve četiri strane.

SUNČANA PREKRIVKA

Plavo platno sa mehurićima sa termičkim efektom, težine 360 m/m², debljine 5mm.

4 SEASONS COVER

Green sheet with eyelets and elastic cords protects the pool at any time of the year from all types of external agents. Seam finishing on all four sides.

SOLAR COVER

Towel blue bubble to thermal effect, weight 360 m/m², thickness 5 mm.

Šifra/code	Model/model	cena/price
COPERTURE 4 STAGIONI CON OCCHIELLI E CORDA ELASTICA / COVERS 4 SEASON WITH EYELETS AND ELASTIC CABLE		
8051300	Prekrivka 4 god.doba 3,60x2,60 / 4 seasons cover	88,50 €
8051301	Prekrivka 4 god.doba 4,60x2,60 / 4 seasons cover	106,20 €
8051303	Prekrivka 4 god.doba 4,60x3,60 / 4 seasons cover	150,45 €
8051325	Prekrivka 4 god.doba 5,10x2,60 / 4 seasons cover	123,90 €
8051302	Prekrivka 4 god.doba 5,60x2,60 / 4 seasons cover	132,80 €
8051304	Prekrivka 4 god.doba 6,10x3,10 / 4 seasons cover	168,20 €
8051305	Prekrivka 4 god.doba 5,60x3,60 / 4 seasons cover	185,90 €
8051309	Prekrivka 4 god.doba 6,60x3,60 / 4 seasons cover	212,40 €
8051310	Prekrivka 4 god.doba 7,60x3,60 / 4 seasons cover	247,80 €
8051313	Prekrivka 4 god.doba 7,60x4,60 / 4 seasons cover	309,80 €
8051311	Prekrivka 4 god.doba 8,60x3,60 / 4 seasons cover	274,40 €
8051314	Prekrivka 4 god.doba 8,60x4,60 / 4 seasons cover	354,00 €
8051312	Prekrivka 4 god.doba 9,60x3,60 / 4 seasons cover	309,80 €
8051315	Prekrivka 4 god.doba 9,60x4,60 / 4 seasons cover	398,30 €
8051321	Prekrivka 4 god.doba Ø3,60 / 4 seasons cover	124,80 €
8051322	Prekrivka 4 god.doba Ø4,10 / 4 seasons cover	166,40 €
8051323	Prekrivka 4 god.doba Ø4,60 / 4 seasons cover	187,20 €
8051324	Prekrivka 4 god.doba Ø6,10 / 4 seasons cover	312,00 €
SUNČANA PREKRIVKA 360 gr/m ² DEBLJINE 5 MM SOLAR COVER 360 gr/m ² THICKNESS 5 MM		
8051330	Sunčana prekrivka 3x2 / solar cover	143,60 €
8051331	Sunčana prekrivka 4x2 / solar cover	191,00 €
8051329	Sunčana prekrivka 4x3 / solar cover	286,50 €
8051332	Sunčana prekrivka 5,50x2 / solar cover	262,60 €
8051351	Sunčana prekrivka 5x2 / solar cover	238,70 €
8051338	Sunčana prekrivka 5x3 m / solar cover	358,00 €
8051354	Sunčana prekrivka 5,50x2,50 / solar cover	328,20 €
8051339	Sunčana prekrivka 6x3 / solar cover	429,70 €
8051340	Sunčana prekrivka 7x3 / solar cover	501,30 €
8051343	Sunčana prekrivka 7x4 / solar cover	607,60 €
8051341	Sunčana prekrivka 8x3 / solar cover	572,90 €
8051342	Sunčana prekrivka 9x3 / solar cover	585,90 €
8051345	Sunčana prekrivka 9x4 / solar cover	781,20 €

WHITE POOL

**SET ČELIČNOG BAZENA :**

- Struktura bela od pocinkovanog čelika, prelakiranom i farbanom, debljine 40/100.
- Skimer + usisna mlaznica.
- Monoblok filtrirajući Mexico sa Aqualoon (filtrirajuće kugle). U kompletu sa povezujućim fittingom.
- Liner plavi debljine 40/100, jednobojni, tretiran protiv UV, protiv buđi i bakterija.
- Stepenice sa sigurnosnom platformom
- Prostirka poda od filca.
- Set za reparaciju.

STEEL SWIMMING POOL KIT :

- White galvanised steel structure, pre-lacquered and painted, thickness 40/100.
- Skimmer + nozzle inlet.
- Mexico filtering monoblock with Aqualoon (filtering spheres). Complete with connection fittings.
- Blue liner thickness 40/100, solid colour, anti-UV treated, anti-mold and anti-bacteria.
- Security steel ladder with platform.
- Felt floor mat.
- Repair kit.



AQUALOON konstituisan je od kuglica vlakana polimera koje, zahvaljujući maloj težini, lako se transportuju i instaliraju, olakšavajući radnje održavanja : 700 grama AQUALOON odgovaraju vreći od 25 kg peska.

AQUALOON consists of polymer fibre balls which, thanks to their light weight, can be easily transported and installed, simplifying maintenance operations : 700 grams of AQUALOON is equivalent to a 25 kg bag of sand.

Šifra/ code	Model/model	Filtrirajući monoblok/ Filter monoblock	Gabarit Na tlu/ footprint	Visina/ eight H [m]	Zapremina	cena/price
8011015	Bazen White Pool 490 White Pool 490	Mexico 300 + Aqualoon	4,90x3,60	1,30 m	15,90 m ³	3.033,00 €
8011012	Bazen White Pool 610 White Pool 610	Mexico 400 + Aqualoon	6,10x3,60	1,30 m	20,40 m ³	3.817,00 €
8011013	Bazen White Pool 730 White Pool 730	Mexico 400 + Aqualoon	7,30x3,60	1,30 m	24,90 m ³	4.491,00 €
8011014	Bazen White Pool 910 White Pool 910	Mexico 500 + Aqualoon	9,10x4,60	1,30 m	40,00 m ³	5.346,00 €

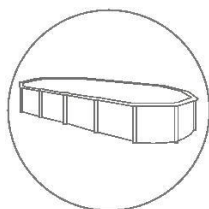

STRUKTURA OD ČELIKA
PANELI 40/100
steel structure
40/100 panels

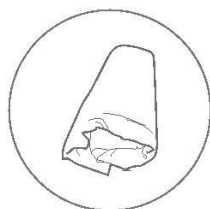

LINER 40/100
liner 40/100

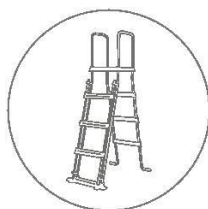

SPOLJNE
STEPENICE
ladder

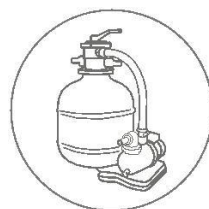

SKLOP ZA FILTRIRANJE
I POVEZNE CEVI
filtration group
and connecting hoses

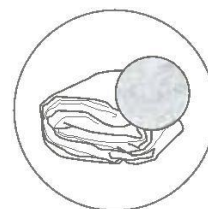

PROSTIRKA
PODA
bottom pad

ACQUAMARINA POOL

**KOMPLET ČELIČNOG BAZENA :**

- Struktura od pocinkovanog čelika, prelakiranom i farbanom, debljine 40/100.
- Skimer + usisna mlaznica.
- Filtrirajući monoblok Mexico sa Aqualoon (filtrirajuće kuglice). U kompletu sa poveznim fittingom.
- Liner debljine 40/100, jednobojni, tretiran protiv UV, protiv buđi i bakterija.
- Čelične stepenice sa sigurnosnom platformom
- Prostirka poda od filca.
- Set za popravke.

STEEL SWIMMING POOL KIT :

- Galvanised steel structure, pre-lacquered and painted, thickness 40/100.
- Skimmer + nozzle inlet.
- Mexico filtering monoblock with Aqualoon (filtering spheres). Complete with connection fittings.
- Liner thickness 40/100, solid colour, anti-UV treated, anti-mold and anti-bacteria.
- Security steel ladder with platform.
- Felt floor mat.
- Repair kit.

AQUALOON sa sastoji od sferičnih kuglica vlakana polimera koji zahvaljujući njihovoj maloj težini, lako se transportuju i instaliraju, olakšavajući radnje održavanja. 700 grama AQUALOON odgovaraju vreći od 25 kg peska.



AQUALOON consists of polymer fibre balls which, thanks to their light weight, can be easily transported and installed, simplifying maintenance operations : 700 grams of AQUALOON is equivalent to a 25 kg bag of sand.

Šifra/code	Model/model	Monoblok filtrirajući/ Filter monoblock	Gabarit na tlu/ footprint	Visina/ eight H [m]	Zapremina	Cena/price
Acquamarina pool boja strukture antracite, liner sivi - Acquamarina pool structure colour anthracite, liner grey						
8011034	Acquamarina pool 490	Mexico 300 + Aqualoon	4,90x5,31	1,20 m	17,00 m³	2.424,00 €
8011035	Acquamarina pool 610	Mexico 400 + Aqualoon	6,10x5,31	1,20 m	22,00 m³	3.023,00 €
8011036	Acquamarina pool 730	Mexico 400 + Aqualoon	7,30x5,31	1,20 m	26,00 m³	3.339,00 €
Acquamarina pool boja strukture BELO, liner Plavi - Acquamarina pool structure colour WHITE, liner BLUE						
8011030	Acquamarina pool 490	Mexico 300 + Aqualoon	4,90x5,31	1,20 m	17,00 m³	2.271,00 €
8011031	Acquamarina pool 610	Mexico 400 + Aqualoon	6,10x5,31	1,20 m	22,00 m³	2.824,00 €
8011032	Acquamarina pool 730	Mexico 400 + Aqualoon	7,30x5,31	1,20 m	26,00 m³	3.117,00 €

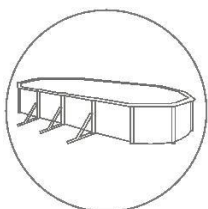

STRUKTURA OD ČELIKA
PANELI 40/100
steel structure
40/100 panels

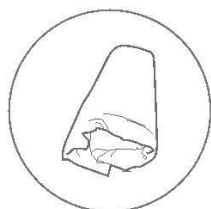

LINER 40/100
liner 40/100

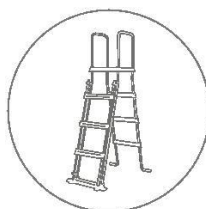

SPOLJNE
STEPENICE
ladder

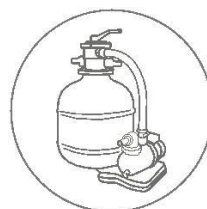

SKLOP ZA FILTRACIJU
I POVEZNE CEVI
filtration group
and connecting hoses

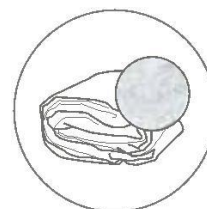

PROSTIRKA
PODA
bottom pad

PREKRIVKE I LINER ZA NADZEMNE BAZENE / COVERS AND LINERS FOR ABOVE GROUND POOLS

SUNČANA PREKRIVKA

Copertura solare in polietilene con alveoli ad effetto termico per mantenere la temperatura dell'acqua ed evitare l'evaporazione. Protegge dall'inquinamento e dalla sporcizia, diminuisce il consumo di prodotti chimici e di trattamento.

COPERTURA INVERNALE

Protegge l'acqua dalle sporcizie provenienti dall'esterno. Utilizzo raccomandato per l'inverno come copertura di protezione.

SOLAR COVER

Solar cover made of polyethylene with alveoli for thermal effect to maintain the temperature of the water and prevent evaporation. Protects from dirt and pollution, reduces the consumption of chemicals and treatment.

WINTER COVER

Protects the water from the dirt from outside. Recommended for winter use as a cover of protection.

Codice/code	Modello/model	Prezzo/price	
LINER AZZURRO / BLUE LINER			
8020074	Liner plavi deb.40/100 6,10x3,60 - h.1,20/1,30 m / blue liner	483,90 €	
8020076	Liner plavi deb.40/100 7,30x3,60 - h.1,20/1,30 m / blue liner	533,80 €	
8020077	Liner plavi deb.40/100 9,15x4,60 - h.1,20/1,33 m / blue liner	761,10 €	
SOLARNA PREKRIVKA/ SOLAR COVER			
8020035	Sunčana prekrivka Ø2,50 m / solar cover	68,50 €	
8020036	Sunčana prekrivka Ø3,00 m / solar cover	84,20 €	
8020037	Sunčana prekrivka Ø3,50 m / solar cover	83,80 €	
8020038	Sunčana prekrivka Ø3,60 m / solar cover	91,80 €	
8020039	Sunčana prekrivka Ø4,60 m / solar cover	118,80 €	
8020040	Sunčana prekrivka Ø5,50 m / solar cover	198,00 €	
8020048	Sunčana prekrivka 4,90x3,70 m	69,60 €	
8020042	Sunčana prekrivka 6,10x3,60 m / 6,10x3,75 m	122,40 €	
8020044	Sunčana prekrivka 7,30x3,60 m / 7,30x3,75 m/ solar cover	197,80 €	
8020046	Sunčana prekrivka 9,15x4,60 m / 9,15x4,70 m/ solar cover	237,60 €	
8080056	Sunčana prekrivka 10,00x5,50 m / solar cover	316,50 €	
ZIMSKA PREKRIVKA Asortiman standard od poliester, plavo/crno, 90 g/m ² WINTER COVER Standard range of polyester, blue / black, 90 g/m ²			
8020051	Zimska prekrivka za bazen Ø3,50 a 3,90 m / winter cover	72,60 €	
8020207	Zimska prekrivka bazena Ø4,60 a 5,00 m/ winter cover	87,10 €	
8020208	Zimska prekrivka bazena Ø5,50 a 6,00m / winter cover	115,20 €	
8080069	Zimska prekrivka bazena 4,90x3,60 m / winter cover	75,10 €	
8080070	Zimska prekrivka bazena 6,10x3,60 m / winter cover	87,00 €	
8020209	Zimska prekrivka bazena 6,10x3,75 m / 6,40x3,90 m / winter cover	100,10 €	
8080071	Zimska prekrivka bazena 7,30x3,60 m / winter cover	98,80 €	
8020210	Zimska prekrivka bazena 7,30x3,60 m / 7,30x3,75 m / winter cover	113,20 €	
8080072	Zimska prekrivka bazena 9,10x4,60 m / winter cover	142,10 €	
8020054	Zimska prekrivka bazena 9,15x4,60 m / 9,15x4,70 m / winter cover	194,00 €	
ZIMSKE PREKRIVKE ZA NADZEMNE BAZENE			
Šifra	Oblik	KORISNE ZA BAZENE	Realna dimenzija cerade
8020051	Okrugla - Round	Ø 3,50 / 3,90	Ø 4,60
8020207	Okrugla - Round	Ø4,60 / 5,00	Ø 5,60
8020208	Okrugla - Round	Ø 5,50 / 6,00	Ø 6,60
8080069	Ovalna - Oval	4,90 x 3,60	5,50 x 4,20
8080070	Ovalna - Oval	6,10 x 3,60	6,70 x 4,20
8020209	Ovalna - Oval	6,10 x 3,75 / 6,40 x 3,90	7,10 x 4,75
8080071	Ovalna - Oval	7,30 x 3,60	7,90 x 4,20
8020210	Ovalna - Oval	7,30 x 3,75	8,30 x 4,75
8080072	Ovalna - Oval	9,10 x 4,60	9,70 x 5,20
8080068	Ovalna - Oval	10,00x5,50	11,10 x 6,60

Šifra/ code	Model/model	Cena/ price
STEPENICE/ LADDERS		
8020024	Sigurnosne stepenice za bazene do 1,30, 4 stepenika, sa platformom Safety ladder for pools up to 1,30, 4 steps, with platform	196,70 €
8020023	Sigurnosne stepenice od čelika za bazene do 1,40, 4 stepenika, sa platformom od drveta Steel safety scale for pools up to 1.40, 4 steps, with wooden platform	356,40 €
SCALE / LADDERS		
1025096	Stepenice Fiesta / Fiesta stairs	1.638,00 €
1025095	Stepenice H2O / H2O stairs	1.117,00 €
1025097	Duple stepenice od smole / Double ladder in resin	534,20 €
1025098	Stepenice od smole / Ladder in resin	327,70 €
ARROTOLATORE REEL / REEL		
8020110	Motalica Reel od aluminijuma sa ramom ABS nadzemna 3x2.10 Reel aluminum with ABS frame above ground 3x2.10	250,00 €
8020108	Motalica Reel od aluminijuma sa ramom ABS za cevne bazene Aluminium Reel with ABS frame for tublar above ground pool	267,00 €
PROSTIRKA PODA OD FILCA / FELT DEEP CARPET		
FILC debljine 100 gr/m2 od vlakna poliestere visoke otpornosti na alla rastezanje. Štiti liner PVC od neravnina tla, doprinosi dodatnom komforu, sprečava povrat vlage grazie svom kvalitetu da netruli. Felt thickness 100 gr/m2 in polyester fiber high resistance to extend. It protects the PVC liner from the unevenness of the ground, provides an additional comfort. It prevents rising moisture thanks to its quality rotproof		
8020258	Prostirka dna od filca 7x4m/ felt deep carpet 7x4m	110,40 €
8020259	Prostirka poda od filca 6x5m/felt deep carpet 6x5m	105,60 €
8020260	Filc dim. 4,00x4,00 m / Felt dim. 4,00x4,00 m	69,40 €
8020261	Filc dim. 5,00x3,50 m / Felt dim. 5,00x3,50 m	85,50 €
8020262	Filc dim. 5,00x5,00 m / Felt dim. 5,00x5,00 m	91,20 €
8020263	Filc dim. 6,00x4,00 m / Felt dim. 6,00x4,00 m	100,80 €
8020264	Filc dim. 8,00x4,50 m / Felt dim. 8,00x4,50 m	148,80 €



cod. 8020024



cod.1025096



cod.1025095



cod. 8020110



cod. 8020108



cod.1025097



cod.1025098

NADZEMNA OPREMA / ACCESSORIES FOR ABOVE GROUND POOLS



Šifra/code	Model/model	Cena/price
8020090	Skimmer + mlaznica / Skimmer + return fitting	57,20 €
8020091	Prirubnica skimera / Flange skimmer	4,00 €
8020106	Poklopac prirubnice skimera / Flange cover skimmer	5,40 €
8020092	Zaptivka duple prirubnice skimer/ Double flange seal skimmer	2,20 €
8020093	Poklopac skimera / Skimmer cap	4,00 €
8020094	Krilce skimera/ Flap skimmer	3,20 €
8020095	Korpica skimera / Skimmer basket	3,00 €
8020104	Zaštitni nosač skimmera zida / Skimmer support protection of the wall	5,00 €
8020096	Vijci skimera / Screws skimmer	4,80 €
8020097	Skimer velikog otvora + mlaznica / Wide mouth skimmer+return fitting	89,80 €
8020098	Prirubnica skimera velikog otvora / Skimmer flange flared mouth	7,50 €
8020107	Poklopac prirubnice skimera velikog otvora / Flange cover wide mouth skimmer	7,20 €
8020099	Zaptivka duple prirubnice skimer velikog otvora / Double flange seal flared mouth skimmer	6,20 €
8020100	Vijci skimera velikog otvora / Flared mouth skimmer screws	8,90 €
8020101	Poklopac skimera sa prstenom plutajuće cevi / Cap skimmer with floating pipe connection	4,00 €
8020102	Kompletna usisna mlaznica / Complete return fitting	9,10 €
8020103	Dupla zaptivka usisne mlaznice / Double joint return fitting	1,10 €
1055355	Tubo corrugato manicottato Ø 32 / Sleeved corrugated pipe Ø 32 al m	5,90 €
1055356	Talasasta cev sa muфом Ø 38 / Sleeved corrugated pipe Ø 38 al m	7,80 €

SKLOP MONOBLOK FILTERA ARGENTO
SAND FILTER SYSTEM ARGENTO



- Filter monoblok (bez peska, vreće od 25 kg)
- Telo filtera od fibreglasa
- Maksimalni korisni pritisak 2 Bar
- Temelje od ABS
- Povezne cevi pumpa /filtercon sa spojevima sa navojem.
- Filter block (sand not included, bags of 25 kg).
- Filter body in fiberglass
- Maximum use of 2 Bar
- ABS support base
- Pipe connecting pump and filter with threaded couplings

Šifra/code	Model/model	Ø mm	Pesak Kg	Protok m ³ /h	Pumpa CV	Cena/price
8 050170	Monoblok Argento 400 - pumpa 6,5 m ³ /h Sand filter system 400 with pump 6,5m ³ /h	400	50	6,5	0,5	650,90 €
8 050171	Monoblok Argento 500 - pumpa 10 m ³ /h Sand filter system 500 with pump 10m ³ /h	500	100	10	0,75	785,10 €

MONOBLOK MEXICO I HAVANA / MEXICO AND HAVANA MONOBLOCK



Cod. 8050113 - 8050114



Cod. 8050053



Cod. 8050050 - 8050051 - 8050052

- Filter monoblok (bez pesak, vreće od 25 kg)
- Telo filtera do polietilene visoke gustine otporan na 2 bar
- Temeđe od ABS
- Povezne cevi pumpa / filter sa naglancima sa navojem
- Filter block (non including sand, bag of 25 kg)
- Filter body in high-density polyethylene resistant to 2 bar
- ABS support base
- Pipe connecting pump and filter with threaded couplings

Šifra/code	Model/model	Ø mm	Pesak Kg	Protok m ³ /h	Pumpa CV	Cena/price
8050050	Monoblok Mexico 300 / Sand filter system with pump 300	300	20	7	0,33	290,40 €
8050051	Monoblok Mexico 400 / Sand filter system with pump 400	400	35	8,5	0,5	384,90 €
8050052	Monoblok Mexico 500 / Sand filter system with pump 500	500	75	10	0,75	438,20 €
8050053	Monoblok Mexico 600 / Sand filter system with pump 600	600	140	22	1,5	669,00 €

Codice/ code	Model/model	Ø mm	Pesak Kg	Protok m ³ /h	Pumpa CV	Cena/price
8 050113	Monoblok HAVANA 500 / Sand filter system with pump 500	500	60	8	0,6	660,00 €
8 050114	Monoblok HAVANA 650 / Sand filter system with pump 650	650	160	15	1	945,70 €

MONOBLOK ALBA SUMMER / ALBA SUMMER MONOBLOCK



Cod. 8050185



Cod. 8050186



Cod. 8050184

- Filteri monoblok
- Bez peska, vreće od 25 kg. Modeli 8050185 i 8 050186 opremljeni sa Aqualoon (8050185 radi samo sa Aqualoon)
- 4 položajni ventil za model 8050186 i 6 položajni za 8050184
- Sa predfilterom (8050184) i bez predfiltera (8050185-8050186)
- Monoblock filters
- Sand not included, 25 kg bags. Models 8050185 and 8050186 supplies with Aqualoon (8050185 works with Aqualoon only)
- 4-way valve for 8050186 model and 6-way valve for 8050184 model
- With prefilter (8050184) and without prefilter (8050185-8050186)

Šifra/code	Model/model	Ø mm	Zapremina piscina/V. pool	Protok m ³ /h	Cena/price
8050185	Alba Summer Easy 10	250	10	4,5	216,00 €
8050186	Alba Summer Middle 15	250	15	4,5	250,00 €
8050184	Alba Summer Top 30	330	30	6	303,00 €

SISTEM PROTIV KOMARACA MOSQUITOS BYE / MOSQUITOS BYE ANTI - MOSQUITO SYSTEM



Vizuelni i estetski uticaj ugradnje profesionalnog sistema je **praktično nikakav**, zahvaljujući intervenciji kvalifikovanog i specijalizovanog osoblja koje će razviti instalaciju duž površine koje se želi zaštititi, koristeći žive ograde, obične i gvozdene ograde kao oslonce, bez remećenja na taj način bašte, pločnika i ranijih građevina. Zahvaljujući malim dimenzijama cevi, mogu se koristiti već postojeći zidovi, ograde, žive ograde i talasaste cevi za njihov prolaz bez intervencija na zidovima ili novih zemljanih radova. Koristimo posebne cevi raznih boja i bezbroj komponenti da bi realizovali najmanje opterećujuće rešenje.



Mosquitos bye projektuje, realizuje i installira sisteme protiv komaraca sa raspršavanjem, zadnje generacije, proučeni i testirani za zaštitu spoljnih i ne, prostora od komaraca i drugih dosadnih insekata.

Zahvaljujući brojnim testovima obavljenim Na terenu i proučavanjima u laboratoriji U saradnji sa specijalizovanim firmama iz sektora možemo instaliranjem jednog sistema protiv komaraca da eliminišemo ili poprilično smanjimo, komarce iz tvoje bašte, maksimalno smanjujući upotrebu proizvoda

Iz iskustva i profesionalnosti Mosquitos bye rođena je jedna nova tehnologija, visoko pouzdana i efikasna koja omogućava realnu zaštitu tvoje bašte od komaraca
O P R E M A M O S Q U I T O S B Y E
J E M A D E I N I T A L Y

PREDNOSTI - ADVANTAGES

Efikasnost brza i trajna u vremenu sa vrlo kratkim vremenom raspršavanje dnevno.

Korišćenje malih doza sa malim uticajem na okolni ambijent Na bazi esencijalnih ulja 100% prirodnih.

Programirana podrška preko naših kvalifikovanih tehničara Radi garancije Efikasnosti i održavanje sistema.

Ne smeta mu kiša niti navodnjavanje

EFIKASNA I NEZAVISNA ZAŠTITA OKOLINE

JEDNO OD EFIKASNIJIH REŠENJA CILJANIH ZA TRAJNO REŠAVANJE
 PROBLEMA KOMARACA U BAŠTI JE TO DA SE NAPRAVI **JEDNA PERIMETRALNA BARIJERA** KOJA BI ONEMOGUĆILA
 KOMARCIMA DA UĐU U PODRUČJE I DA UDALJI VEĆ PRISUTNE

2. Pozicioniramo
 Duž perimetra
 Cevi i mlaznice.

Proizvodi ne stvaraju probleme-
 scono probleme zagađivanja vode
 bazena

3. Napunimo
 Rezervoare proizvodima,
 programiramo
 mašinu
 namenski
 prema
 karakteristikama
 tvoje bašte
 i pustimo u funkciju uređaj.

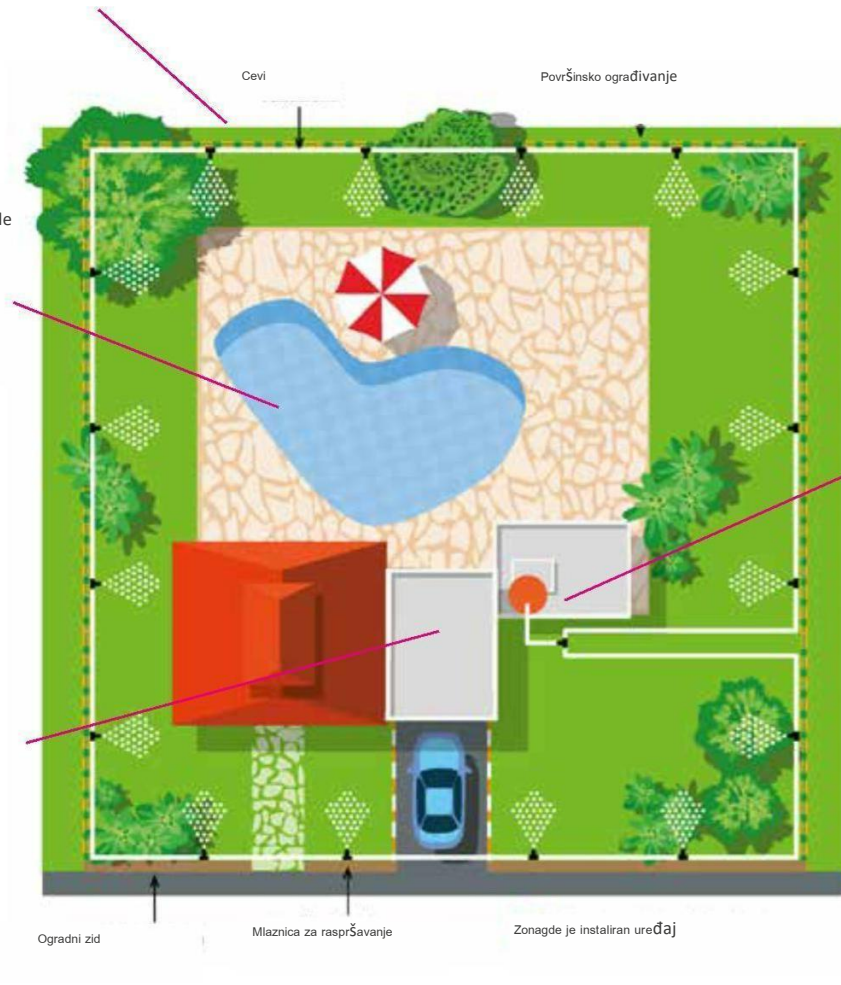

1. Centralnu jedinicu
 instaliramo na strujnu
 utičnicu i priključak na
 vodu

Model	Cena
Uređaj protiv komaraca za baštu kompletnu sa opremom, cevima i mlaznicama do 1.200 mq	Cena na upit



U SETU BAZENA

- Liner 60/100 plavi ili pesak, tretiran protiv UV
- Prostirka poda od sigurnosnog filca protiv bakterija
- Monoblok sklop sa peščanim filterom i pumpom
- Spoljne stepenice od drveta
- Stepenice za pristup unutra od čelika
- Komplet za održavanje (metla usisivač, površinska mrežica, teleskopska ručka, plutajuća cev, paket za analizu vode)

IN THE SWIMMING POOL KIT

- *Blue or sand liner thickness 60/100, UV resistant*
- *Bottom pad with felt*
- *Sand filter system with pump*
- *External wood staircase*
- *Scale for internal access*
- *Maintenance Kit (vacuum head, surface net, telescopic handle, floating hose, kit water analysis)*

pag. 457

NIAGARA

drveni bazen

WOODEN SWIMMING POOL

Wellness
SPA



12





Sadržaj

SPA HIDROMASAŽA

- 476 LIBERTY SPA
- 478 YUI SPA / YUI HYDROMASSAGE SPA
- 482 MINI BAZEN TIRRENA / MINI POOL TIRRENA
- 484 SAMOSTOJEĆI BAZEN ADRIATICA/ADRIATIC INDEPENDENT POOL
- 486 OPREMLJENOST SPA / SPA FACILITIES
- 487 DUETTO
- 488 REGINA
- 489 ORCHIDEA
- 490 MAGNOLIA
- 491 ATOLLO
- 492 ORTENSIA
- 493 VALENTINA
- 494 MAJOR
- 495 ROKÀ
- 496 CRISTAL
- 497 IMPERIAL
- 498 MISTRAL
- 499 TEHNIČKA SPECIFIKACIJA SPA/ SPA TECHNICAL SPECIFICATIONS
- 500 POLLUX
- 501 JULIA 250
- 502 OPREMA SPA / SPA ACCESSORIES
- 503 PROJEKTI CENTRI SPA - WELLNESS CENTERS PROJECTS

SAUNE

- 509 SAUNE FINSKE / FINNISH SAUNAS
- 510 SAUNE INFRA CRVENI ZRACI/ INFRARED SAUNAS
- 512 SAUNE PROFESIONALNE / PROFESSIONAL SAUNAS
- 513 SAUNE ZA BAŠTU / SAUNAS FOR GARDEN
- 514 BAČVE SAUNE / BARREL SAUNAS
- 515 OPREMA ZA SAUNE/ACCESSORIES FOR SAUNAS

PEĆI/ STOVES

- 517 SA UGRAĐENOM KONTROLOM / WITH INTEGRATED CONTROL
- 518 SA SPOLJNOM KONTROLOM / WITH EXTERNAL CONTROL
- 518 PEĆI ZA BIO SAUNE / STOVES FOR BIO SAUNAS

TURSKO KUPATILO / HAMMAM

- 520 KABINA PRAVOUGAONE I ČETVRTASTE OSNOVE / RECTANGULAR AND SQUARE BASE CABIN
- 521 KABINA DIAMANTE / DIAMOND CABIN
- 522 OPREMA ZA TURSKO KUPATILO / HAMMAM ACCESSORIES
- 523 GENERATORI ZA TURSKO KUPATILO / HAMMAM STEAM GENERATORS

TUŠ KABINE / SHOWERS

- 525 PERLA E RUBINO
- 526 TROPIKALNE KAPI I HALNI POVETARAC / TROPICAL DROPS AND COLD BREEZES
- 527 TUŠEVI/ HEADSHOWERS



LIBERTY



2 Ležeća mesta
2 lounge



Protivstrujno plivanje
counter current
System



2 sedišta
2 seats



YUI



3 ležišta
3 lounge

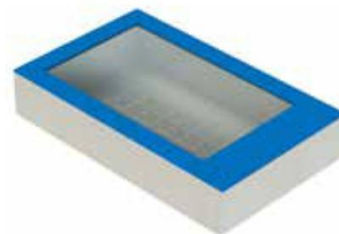

TIRRENA



Unutrašnje
stepenište
inside ladder



ADRIATICA



Unutrašnje i spoljne
stepenice
inside and
outside ladder



ATOLLO



2 sedišta
2 seats



REGINA



3 sedišta
3 seats



DUETTO



2 sedišta
2 seats



2 ležišta
2 lounge



POLLUX



7 sedišta
7 seats



JULIA



5 sedišta
5 seats



ORCHI DEA



2 sedišta



1 ležaljka



MAGNO LIA



3 sedišta



2 ležaljke



ORTENSIA



3 sedišta



VALENTINA



4 sedišta



1 ležaljka



MAJOR



3 sedišta



2 ležaljke



ROKA



3 sedišta



2 ležaljke



CRISTAL



5 sedišta



1 ležaljka



IMPERIAL



3 sedišta



Protivstrujno plivanje



MISTRAL



4 sedišta



1 ležaljka



Protiv strujno plivanje

LIBERTY SPA



La Liberty SPA izvanredno odgovara malim prostorima. Njene kompaktne dimenzije olakšavaju njeno uklanjanje i instalaciju kako napolju tako i unutra održavajući pak prednosti jednog tradicionalnog bazena. La Liberty SPA je koncentrat tehnologije, opremljena za vašu dobrobit

sa:

- Protivstrujno plivanje
- 2 hidromasažna sedišta
- 2 hidromasažne ležaljke
- Automatski sistem grejanja
- Nominalne dimenzije: 2,28 x 4,94 x 1,34 m

Liberty SPA perfectly adapts to small spaces. Its compact dimensions facilitate its integration and installation outside as inside, while maintaining the advantages of a traditional swimming pool. Liberty SPA is a combination of technology, equipped for your well-being with:

- Counter-current swimming
- 2 hydromassage seats
- 2 hydromassage chaise longue
- Automated heating system
- Nominal size: 2,28 x 4,94 x 1,34 m



BOJE / COLOURS



sicevi
seats



ležaljka
lounger

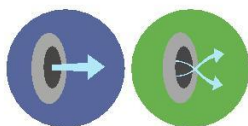

mlazevi vode
water jets



vazdušni
mlazevi
air jets



protivstrujno plivanje
counter-current swimming

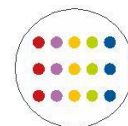

led rasveta
led lighting



OPREMA / EQUIPMENT

HIDROMASAŽA-PROTIVSTRUJNO PLIVANJE / HYDROMASSAGE COUNTER-CURRENT SWIMMING

2 Hidromasažna sedišta / 2 hydromassage seats
2 Ležaljke vazdušna masaža / 2 air massage lounger

2 Hidromasažne pumpe 2 cv
2 hydromassage pumps 2 cv

1 pumpa NCC 3 cv, 40 m³/h
1 against current pump 3 cv, 40 m³/h

1 blower 0,9 kW vazdušna masaža
1 blower 0,9 kW air massage

FILTRACIJA / FILTRATION

1 skimmer, 2 mlaznice / 1 skimmer, 2 return fitting

1 mašinski prostor / 1 technical housing

1 filtraciona pumpa / 1 filtration pump

1 filter sa uloškom / 1 cartridge filter

1 Komandna tabla sa planiranjem vremena filtracije sa električnim grejačem
1 control panel with planning filtration slots with electrical heater

1 Komandni panel / 1 control panel

OPREMA / ACCESSORIES

1 REFLEKTOR LED - 1 LED projector

APSORBOVANJA / REMOVALS

Napajanje monofazno ili trofazno na upit / Single-phase or three-phase power on request

Filtracija i Grejanje [kW]
Filtration and heating

4,1

Hidromasaža / Hydromassage [kW]

6,2

Max [kW]

6,2



Copertura rigida SPA Liberty
Hard cover for SPA Liberty
code 8200193

Šifra/code	Opis/description	Cena/price
8200151	Liberty SPA prestige - kompletna (vd. tabela opremanja) / Full optional (see equipment table)	30.440,00 €
8200254	Liberty SPA obložena / Liberty SPA with panelling	33.090,00 €
	Optioni / options	
8200193	Prekrivka tvrda SPA Liberty / Hard cover SPA Liberty	1.200,00 €



VASCA SPA YUI / YUI HYDROMASSAGE SPA



YUI è la vasca idromassaggio elegante e minimale realizzata in acrilico, rinforzata in fibra di vetro e completa di locale tecnico integrato all'interno della struttura della spa. Il design pulito, lineare e contemporaneo rendono Yui un complemento non solo di benessere, grazie alle sue numerose bocchette massaggianti, ma anche di arredo. Adatto ad ambienti interni ed esterni si inserisce con armonia in ogni contesto.

YUI is the elegant and minimal hot tub made of fiberglass, reinforced in acrylic and complete with a technical room integrated within the spa structure. The clean, linear and contemporary design make Yui a complement not only for well-being, thanks to its numerous massage jets, but also for refined furniture. Suitable for indoor and outdoor environments, it fits harmoniously into any context.

Caratteristiche / Features

Volume d'acqua <i>Water volume</i>	1000 l
Versione ad incasso <i>Built-in Spa</i>	360 kg (peso vuota/empty weight)
Versione completa <i>Complete version</i>	430 kg (peso vuota/empty weight)
Dimensioni <i>Dimensions</i>	2100 x 2350 x 860 mm
Sedute <i>Seats</i>	3
Getti d'acqua e getti d'aria <i>Water jets and air jets</i>	Sì/Yes
Illuminazione a LED <i>LED lighting</i>	Sì/Yes
Controllo digitale <i>Digital control</i>	Sì/Yes
Quadro comando <i>Control system</i>	SP800

COLORI / COLOURS

Interno vasca
tub interior



midnight opal white



pearlescent

pannelli laterali
lateral panels



white

cuscino vasca
spa pillow



warm grey white



COPERTURA SU MISURA / RIGID DESIGN COVER



BOCCHETTE RETROILLUMINATE / BACKLIT RETURN FITTING





Model Model	Potrošnja* Consumption kW	Isporučeni uređaji Supplied devices	količina Quantity	Potrošnja Consumption kW/h
SPA YUI	3,6	Pumpa za hidro-cirkulaciju / Hydro-circulation pump	1	0,40/1,85
		Duvalica single-speed / Single-speed blower	1	0,4
		Duvalica multi-speed 1,2 hp / Multi-speed blower 1,2 hp	1	0,94
		Kontrolna tabla sa grejačem / Control panel with integrated heater	1	3,0
		Reflektor LED / LED lighting	1	0,08

*Maksimalna nominalna potrošnja u uslovima rada / *Maximum nominal absorption under operating conditions

Šifra/code	Opis/description	Cena/price
8200148	Spa YUI ugradna verzija/Built-in version YUI spa	12.791,00 €
8200186	Spa YUI kompletna sa bočnim panelima/Complete YUI spa with lateral panels	14.015,00 €
8200157	Prekrivka tvrda siva/Grey rigid cover	560,00 €

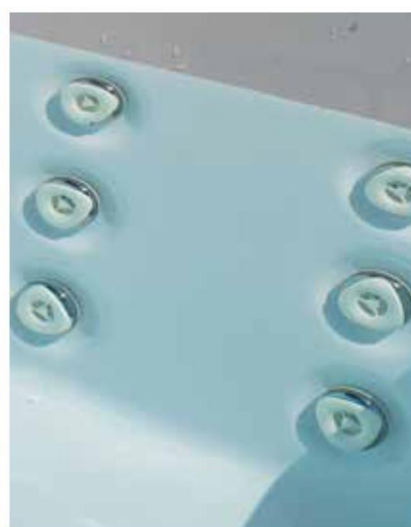

ITALIJANSKA PROIZVODNJA

KOMANDNA PLOČA

FILTRIRANJE I
GREJANJE

MAŠINSKI PROSTOR

AROMATERAPIJA



MEKANI, VODONEPRO-
PUSNI JASTUK

VODENI MLAŽEVI



IZOTERMIČKI POKLOPAC



ZRAČNI MLAŽEVI



BOČNE PLOČE



Mala veličina čini **TIRRENA** najboljim rešenjem za unutrašnje prostore i male spoljne ambijente. Zahvaljujući svojim posebnim završnim obradama, u stanju je dati intimnu i opuštajuću atmosferu. To je model koji najbolje omogućava personalizaciju, čak i estetske prirode.

Standardna isporuka uključuje potpurnu konstrukciju, unapred sastavljeni ram, skimer, oblogu dna i jastuke perimetralnih ivica.

Odrađene standardne rupe za opremu koja se koristi.

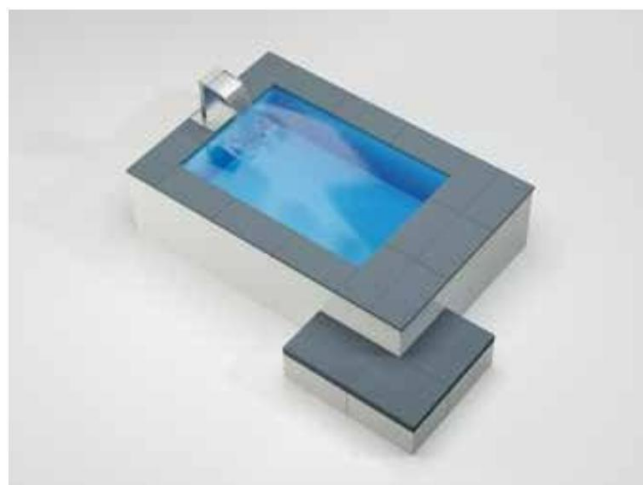

STRUKTURA

Struktura se sastoji od stubova, popuna perimetralnog dna, ploča za podešavanje, skimera, unutrašnjih panela, Korišteni materijal je Z275 vruće pocinčani i duploplastificirani konstrukcijski čelik S280, obrađen laserskim rezanjem i savijanjem.

TEHNIČKI PODACI

Visina vode: 70 cm

Spoljna visina s ramom: 100 cm

Modularnost unutarnjih panela: od 80cm

Otisak podne konstrukcije: plus 80 cm

PERIMETRALNI RUBNI JASTUCI



Vodootporni jastuci od suđera spolja presvućeni nautiĉkom koŹom.

Dostupne boje: Royal Blue i Dark Grey.



Kraljevsko plava tamnosiva

SPOLJNE PRESVLAKE I PRIBOR

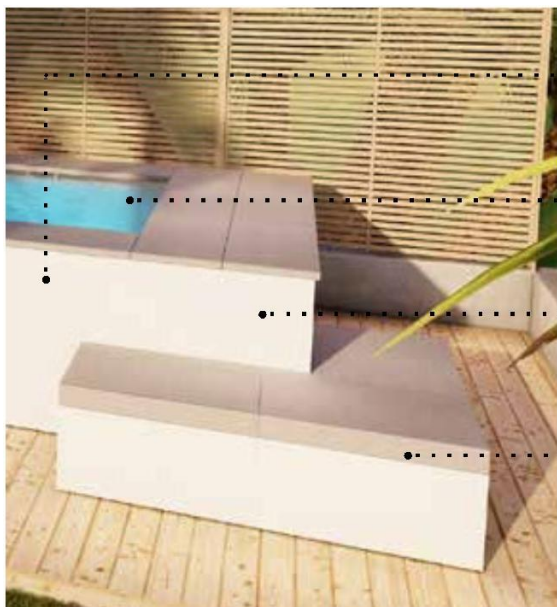

Pocinćane ćelićne ploće s 3 vrste završnih obrada: plastificirane, Pocinćana, pocinćana farbana. Boju farbe potražite u RAL tablici.

Unutrašnja klupa u standardnom formatu ili po meri na zahtev kupca.

Prostor s jastucima

Pouf s podesivim jastukom

DOSTUPNE DIMENZIJE

B

U



Šifra	Spoljne dimenzije [m]		Unutarnje dimenzije [m]			Oprema
	U	B	U	B	Visina [m]	Lampa [n°]
4030518	3,2	4	2,4	3,2	0,8	1
4030519	3,2	4,8	2,4	4	0,8	1
4030520	3,2	5,6	2,4	4,8	0,8	1
4030521	3,2	6,4	2,4	5,6	0,8	1
4030522	4	4	3,2	3,2	0,8	1
4030523	4	4,8	3,2	4	0,8	1
4030524	4	5,6	3,2	4,8	0,8	1
4030525	4	6,4	3,2	5,6	0,8	1

Cene na upit

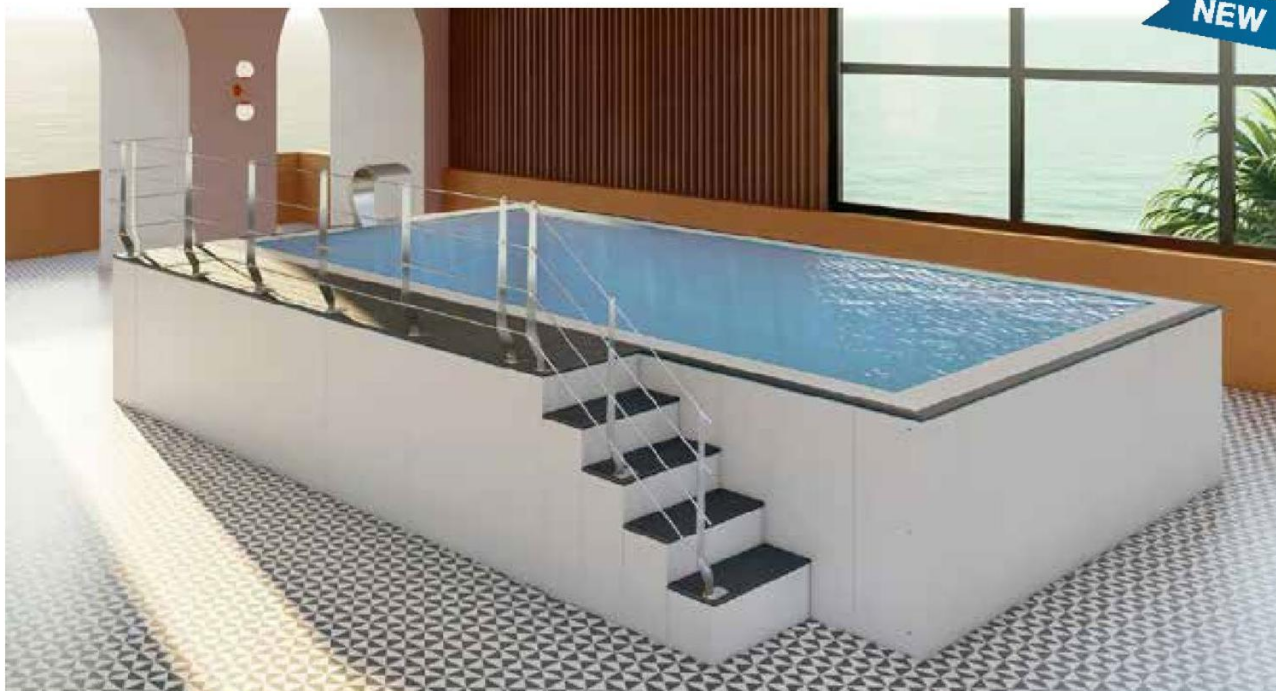

ADRIATICA je neuporedivo nadzemno rešenje preliva s modularnom, samonosivom metalnom konstrukcijom. Čiste linije, adaptacija zahvaljujući raznim dodacima, **ADRIATICA** se može pozicionirati u bilo kojem kontekstu bez pribjegavanja ovlaštenjima i građevinskim radovima, drastično smanjujući vrijeme i troškove gradnje. Unaprijed sastavljeni okvir, dostupan dodatno, omogućuje ugradnju bazena izravno na neravnom terenu i ne zahtijeva nikakvu vrstu betonske ploče. Kompenzacijski spremnik integriran izravno u konstrukciju izbjegava potrebu za vanjskom tehničkom sobom, optimizirajući vrijeme ugradnje i osiguravajući bolje korištenje prostora uz bazen. Standardne rupe za bušenje uključene u korišteni prib

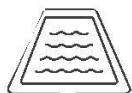

Prelivna ivica



Pogodno za sve terene



Brza montaža

TEHNIČKI PODACI

Visina vode: 120cm

Spoljna visina bez rama: 127cm

Spoljna visina s ramom: 137cm

Modularnost unutrašnjih panela: od 90cm

Gabarit podne konstrukcije: plus 80cm

Konstrukcija se sastoji od zidova, donjeg dna, ploča za podešavanje, unutrašnjih panela, korišteni materijala je konstrukcijski čelik S280 presvučen Magnelisom i obložen prahom, obrađen laserskim rezanjem i savijanjem.

Ploča za podešavanje
kanala
zid
Ploče za podešavanje

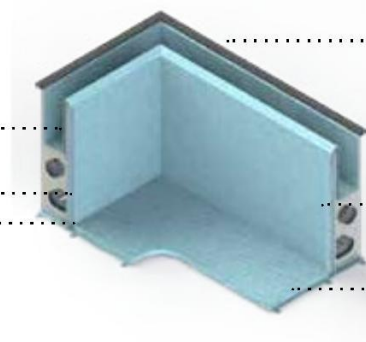

Aluminijska završna obrada
Prelivni kanal
Ploča



Pocinčane čelične ploče s 3 vrste završnih obrada: plastificirane, pocinčane, obojene pocinčane. Boju lakiranja potražite u RAL tablici.

Dizajnirajte parapet od nerđajućeg čelika kako bi odgovarao stepeništu sa stazom. Položaj rukohvata (desno ili levo) zavisi o postavljanju stepeništa.

Spoljne stepenice od pocinčanog čelika koriste oblogu bazena i opremljene su WPC gornjom završnom obradom. Unutrašnji prostor staze može se koristiti kao tehnički odjeljak.

DOSTUPNE DIMENZIJE



Šifra	Spoljne dimenzije [m]		Unutrašnje dimenzije m			Oprema
	U	B	U	B	Visina [m]	Lampa [n°]
4030500	3,5	5,3	2,7	4,5	1,2	1
4030501	3,5	6,2	2,7	5,4	1,2	1
4030502	3,5	8	2,7	7,2	1,2	1
4030503	3,5	8,9	2,7	8,1	1,2	1
4030504	3,5	9,8	2,7	9	1,2	1
4030505	3,5	11,6	2,7	10,8	1,2	1
4030506	4,4	5,3	3,6	4,5	1,2	1
4030507	4,4	6,2	3,6	5,4	1,2	1
4030508	4,4	8	3,6	7,2	1,2	1
4030509	4,4	8,9	3,6	8,1	1,2	1
4030510	4,4	9,8	3,6	9	1,2	1
4030511	4,4	11,6	3,6	10,8	1,2	1
4030512	5,3	5,3	4,5	4,5	1,2	1
4030513	5,3	6,2	4,5	5,4	1,2	1
4030514	5,3	8	4,5	7,2	1,2	1
4030515	5,3	8,9	4,5	8,1	1,2	1
4030516	5,3	9,8	4,5	9	1,2	1
4030517	5,3	11,6	4,5	10,8	1,2	1

Cene na upit -

SPA OPREMA



Sedišta



LED rasveta



Ležaljke



Digitalna kontrola



vazdušne mlaznice



aromaterapija



Vodene mlaznice



Generator ozona

FINITURE KADE

Za sve Spa osim Spa Maestral i Spa Imperial, koje su dostupne samo u srebrno belom mermeru.



Gips



biser



Okeanski talas



Kameni Opal



srebrno beli mermer



Ponoćni opal

BOJE ZA OBLAGANJE



sivo



kafa

BOJE POKLOPCA

Izotermički poklopac sprečava isparavanje vode i omogućava održavanje temperature konstantnom.

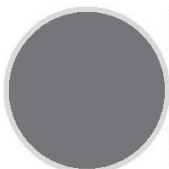

sivo

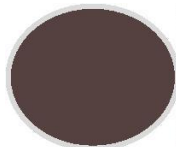

kafa

STEPENICE ZA PRISTUP SPA



sivo



kafa

DUETTO



NEW

Karakteristike / Features	
Zapremina vode / Water volume	1080 L
Težina prazne / Weight empty	360 kg
Dimenzije / Dimensions	2350x2350x790 (dupli modul) 2350x1175x790 (singl modul)
Sedišta / Seats	2
Ležaljke / Chaise longue	2
Vazdušni mlazevi / Air jets	Da/Yes
LED rasveta / LED lighting	Da/Yes
Digitalna kontrola / Digital control	Da/Yes
Komandna tabla / Control system	U boji



Šifra/code	Opis/description	Cena/price
5050457	Spa Duetto dimezija: 2350x2350x790 mm / Duetto Spa	NA UPIT ON DEMAND
5050498	Prekrivka tvrda / Rigid cover	

Model Model	*POTROŠNJA Consumption kW	Isporučeni uređaji Supplied devices	Količina Quantity	Potrošnja Consumption kW/h
SPA DUETTO	3,6	Pompa per la circolazione/ Circulation pump	1	0,5
		Soffiante aereomassaggio/ Air-massage pump	1	0,9
		Quadro di controllo con riscaldatore Control panel with integrated heater	1	3,0
		Faro LED / Led lighting	1	0,08

*Maksimalna nominalna potrošnja u uslovima rada / *Maximum nominal absorption under operating conditions

SPA karakteristike

Zapremina vode	1500 l
Težina prazne	312 kg
Dimenzije	2080x2080x950 mm
Sedišta	5
Mlaznice vazdušne i vodene	Da/Da
LED rasveta	Da/Da

Komandni komplet (samo za šifru.5050460)

SP800 komandna ploča i tastatura s integrisanim grejačem od 3 kW. Napajanje 230/400V.

REGINA kompletna

Šifre	Opis	Cena
5050459	Regina za STANDARD ugradnju bez skimera / komandni panel nije uključen	7.989,00 €
5050460	Regina ugradna KOMPLETNA opremljena filtracijskim sistemom, skimmerom i upravljačkom pločom	10.356,00 €
5050502	Sivi tvrdi poklopac	520,00 €
5050503	Tvrdi poklopac kafa boje	520,00 €
PRIBOR KOMPLEMENTARAN STANDARDNOJ VERZIJI		
1040015	Kontrola bazena za 1 opremu 1,5 - 2,2kW (2 - 3 KS)	474,40 €
1040013	Kontrolna pneumatska tabla bazena za jedan uređaj 0,75 - 1,1kW(1 - 1,5Ks)	348,80 €
1055088	Pneumatski prekidač Ø45.7 u ABS hromiran	45,90 €
1055085	Istureni pneumatski prekidač u ABS-u beli	26,10 €
1070524	Fleksibilno PVC prozirno crevo Ø 3 mm unutrašnje x Ø 5 mm spoljno	2,00 €

Model	Potrošnja* kW	Isporučeni uređaji	Količina	Potrošnja kW/h
SPA REGINA STANDARD	3,8	Hidromasažna pumpa 2hp	2	1.5 svaki
		Kompresor	1	0,7
		RGB rasvjeta	1	0,2
SPA REGINA KOMPLETNA SA	3,8	Hidromasažna pumpa 2hp	2	1.5 kom/svaki
		Kompresor	1	0,7
		Upravljačka ploča s integrisanim grejačem	1	3
FILTRACIJOM		Filtracijska pumpa	1	0,37
		Generator ozona	1	0,01
		RGB rasveta	1	0,01

*Maksimalna **nominalna potrošnja u radnim uslovima**

ORCHIDEA



KARAKTERISTIKE

Volumen vode	1100 l
Težina prazna	285 kg
Dimenzije	2180x1580x880 mm
Sedišta	2
Ležaljka	1
Mlaznice vodene i zračne	Da
LED <i>rasveta</i>	Da
Mlaz vode	Da
Aromaterapija	Da
Generator ozona	Da
Digitalna <i>kontrola</i>	Da
Komandna tabla	SP800

Šifre	Opis	cena
5050457	Dimenzije spa orhideje: 2180x1580x880 mm	10.436,00 €
5050498	Sivi tvrdi poklopac	472,00 €
5050499	Tvrdi poklopac kafe boje	472,00 €
5050471	Drvene stepenice za spa	260,00 €
5050470	Podizač poklopca	320,00 €



Model	* Potrošnja kW	Isporučeni uređaji	Količina	Potrošnja kW/h
SPA ORHIDEJA	3,4	Hidromasažna pumpa 3 KS	1	2,2
		Ćirkulaciona pumpa	1	0,37
		Kompresor	1	0,4
		Komandna tabla sa grejaćem	1	3,0
		Generator ozona	1	0,01
		LEd prednja lampa	1	0,01

*Maksimalna *nominalna* apsorpcija u radnim uslovima

MAGNOLIA



Karakteristike

Volumen vode	1600 l
Težina prazne	335 kg
Dimenzije	2180x2180x880 mm
Sedišta	3
Ležaljke	2
Vodene i zračne mlaznice	Da
LED rasveta	Da
Mlaz vode	-
Aromaterapija	Da
Generator ozona	Da
Digitalna kontrola	Da
Komadna tabla	SP800

Šifre	Opis	Cena
5050451	Magnolia Spa dimenzije: 2180x2180x880 mm	11.884,00 €
5050494	Sivi tvrdi poklopac	512,00 €
5050495	Tvrdi poklopac kafa boje	512,00 €
5050471	Drvene stepenice za spa	260,00 €
5050470	Podizač poklopca	320,00 €



Model	* Potrošnja kW	Isporučeni uređaji	Količina	Potrošnja kW/h
SPA MAGNOLIA	3,5	Pompa idromasaggio 2 KS / Hidromasažna pumpa 2 KS	2	Svaki po 1,5.
		Pompa per l'circolazione / Cirkulacijska pumpa	1	0,37
		Puhalice	1	0,4
		komandna tabla s grejačem	1	3,0
		Generator ozona	1	0,01
		LED lampa	1	0,01

*Maksimalna nominalna potrošnja u radnim uslovima



SPA Karakteristike

Volumen vode	1100 l
Težina prazne	105 kg
Dimenzije	1700x650 mm
Sedišta	2
Vazdušne i vodene mlaznice	Da
Radio komandna tabla s grejačem od 1,5 kW I napajanjem 230V	

Šifra	Opis	Cena
5050400	Mehurići Atollo	8.690,00 €
5050401	Atollo Talasi	9.550,00 €

Model	* Potrošnja kW	Isporučeni uređaji	Količina	Potrošnja kW/h
ATOLLO		Cirkularna pumpa	1	100 W
MEHURIĆI	3,8	Kompresor	1	900 W
		Grejač	1	1500 W
ATOLLO TALASI	3,8	2-brzinska Cirkularna pumpa	1	400-1880 W
Kompresor		1	900 W	
Grejač		1	1500 W	

*Maksimalna nominalna potrošnja u radnim uslovima



HIDROMASAŽNA SPA

ORTENSIA



Karakteristike	
Volumen vode	1500 l
Prazna težina	312 kg
Dimenzije	2080x2080x950 mm
Sedišta	5
Ležaljke	-
Mlaznice vazdušne i vodene	Da
LED rasveta	Da
Mlaz vode	-
Aromaterapija	Da
Generator ozona	Da
Digitalna kontrola	Da
Komandna tabla	SP800

Šifre	Opis	Cena
5050458	Dimenzije spa hortenzije: 2080x2080x950 mm	10.927,00 €
5050500	Sivi tvrdi poklopac	520,00 €
5050501	Tvrdi poklopac kafe boje	520,00 €
5050471	Drvene stepenice za spa	260,00 €



DOSTUPNE BOJE



Ponoćni opal



Bela

Model	* Potrošnja kW	Isporučeni uređaji	Količina	Potrošnja kW/h
SPA ORTENSIA	3,8	Hidromasažna pumpa 2 KS	2	Svaki po 1,5.
		Cirkulaciona pumpa	1	0,37
		Kompresor	1	0,7
		Komandna tabla sa grejačem	1	3,0
		Generator ozona	1	0,01
		LED lampa	1	0,01

*Maksimalna nominalna potrošnja u radnim uslovima

VALENTINA



Karakteristike

Volumen vode	1200 l
Težina prazne	280 kg
Dimenzije	1950x1950x820 mm
Sedišta	4
Ležaljke	1
Mlaznice vazdušne i vodene	Da
LED <i>rasveta</i>	Da
Vodeni mlaz	3 jet 1 mlaz 1
Aromaterapija	Da
Generator ozona	Da
Digitalna kontrola	Da
Komandna tabla	SP800

Šifre	Opis/opis	Cena
5050486	Spa Valentina dimenzije: 1950x1950x820 mm / Valentina Spa	10.975,00 €
5050514	Sivi tvrdi poklopac	400,00 €
5050515	Tvrdi poklopac boje kafe	400,00 €
5050471	Drvene stepenice za spa	260,00 €
5050470	Podizač poklopca	320,00 €



Model	* Potrošnja kW	Isporučeni uređaji	Količina	Potrošnja kW/h
SPA		Hidromasažna pumpa 2 KS	2	Svaki po 1,5.
		Pumpa per l'cirkulacija / Cirkulacijska pumpa	1	0,37
		Puhalice	1	0,4
		Komandna tabla s grejačem	1	3,0
VALENTINA	3,5	Generator ozona	1	0,01
		Led lampa	1	0,02

*Maksimalna nominalna potrošnja u radnim uslovima



K	
Volumen vode	1800 l
Težina prazne	403 kg
Dimenzije	2300x2300x880 mm
Sedišta	3
Ležaljke	2
Mlaznice vazdušne i vodene	Da
LED rasveta	Da
Mlaz vode	-
Aromaterapija	Da
Generator ozona	Da
Digitalna kontrola	Da
Komadna tabla	SP1200

Šifre	Opis	Cena
5050452	Spa Major dimenzije: 2300x2300x880 mm	12.575,00 €
5050506	Sivi tvrdi poklopac	528,00 €
5050507	Sivi poklopac boje kafe	528,00 €
5050471	Drvene stepenice za spa	260,00 €
5050470	Podizač poklopca	320,00 €



Model	* Potrošnja kW	Isporučeni uređaji	Količina	Potrošnja kW/h
SPA MAJOR	5,3	Hidromasažna pumpa od 2 KS	2	Svaki po 1,5.
		Cirkulaciona pumpa	1	0,4/1,85
		<i>Kompresor</i>	1	0,4
		Komandna tabla sa grejačem	1	3,5
		Generator ozona	1	0,01
		LEd lampa	1	0,01

*Maksimalna nominalna potrošnja u radnim uslovima.



Karakteristike

Volumen vode	1900 l
Težina prazne	360 kg
Dimenzije	2200x2200x880 mm
Sedišta	3
Ležaljke	2
Vazdušne i vodene mlaznice	Da
LED rasveta	Da
Mlazevi vode	Da
Aromaterapija / Aromaterapija	Da
Generator ozona	Da
Digitalna kontrola	Da
Komandna tabla	SP1200

Šifra	Opis	cena
5050431	Spa Roka dimenzije: 2200x2200x880 mm / Rokà Spa	13.418,00 €
5050434	Sivi tvrdi poklopac	528,00 €
5050435	Tvrdi poklopac boja kafe	528,00 €
5050471	Drvene stepenice za spa	260,00 €
5050470	Podizač poklopca	320,00 €



Model	* Potrošnja kW	Isporučeni uređaji	Količina	Potrošnja kW/h
ROKA	6,85	Pumpa od 3 KS	2	2.2 svaki.
		Cirkulaciona pumpa	1	0,4/1,85
		Kompresor	1	0,4
		Upravljačka ploča s grejačem	1	3,5
		Generator ozona	1	0,01
		LEd lampa	1	0,01

*Maksimalna nominalna potrošnja u radnim uslovima

Karakteristike

Volumen vode	1800 l
Težina prazne	390 kg
Dimenzije	2300x2300x880 mm
Sedišta	5
Ležaljke	1
Vodne i vazdušne mlaznice	Da
LED rasveta	Da
Aromaterapija	Da
Generator ozona	Da
Digitalna kontrola	Da
Komandna tabla	SP1200

Šifra	Opis	Cena
5050426	Spa Cristal dimenzije: 2300x2300x880 mm	12.655,00 €
5050429	Sivi tvrdi poklopac	580,00 €
5050430	Tvrdi poklopac kafene boje	580,00 €
5050471	Drvene stepenice za Spa	260,00 €
5050470	Podizač poklopca	320,00 €



Model	* Potrošnja kW	Isporučeni uređaji	Količina	Potrošnja kW/h
SPA CRISTAL	6,85	Pumpa od 3 KS / 3 KS	2	2.2 svaki.
		Pumpa per l'cirkulacija / Cirkulacijska pumpa	1	0,4/1,85
		Kompresor	1	0,4
		Kontrolna tabla sa grejačem	1	3,5
		Generator ozona	1	0,01
		LEd lampa	1	0,01

*Maksimalna nominalna potrošnja u radnim uslovima

Karakteristike

Volumen vode	4700 l
Težina prazne	1100 kg
Dimenzije	3900X2280X1350 mm
Sedišta	3
Ležaljke	-
Mlaznice vodene i vazdušne	Da
Protivstrujno plivanje	Da
LED <i>rasveta</i>	Da
Mlaz vode	Da
Aromaterapija	Da
Generator ozona	Da
Digitalna kontrola	Da
Komandna tabla	SP1200

Šifra	Opis	Cena
5050480	Spa Imperial dimenzije: 3900x2280x1350 mm	26.000,00 €
5050516	Sivi tvrdi poklopac	1.000,00 €
5050517	Tvrdi poklopac kafene boje	1.000,00 €



Model	* Potrošnja kW	Isporučeni uređaji	Količina	PotrošnikW/h
SPA IMPERIAL 6,7		Pumpa od 3 KS / 3 KS	3	2,2 svaki
		Cirkulaciona pumpa	1	0,37svaki
		Kompresor	-	-
		Komandna tabla	1	3,5
		Generator ozona	1	0,01
		Led lampa	2	0,02

*Maksimalna nominalna potrošnja u radnim uslovima

Karakteristike

Volumen vode	7680 l
Težina prazne	1100 kg
Dimenzije	5800x2200x1200 mm
Sedišta	4
Ležaljke	1
Mlaznice vode i vazduha	Da
Protivstrujno plivanje	Da
LED <i>rasveta</i>	Da
Mlaz vode	Da
Aromaterapija	Da
Generator ozona	Da
Digitalna <i>kontrola</i>	Da
Komadna tabla	SP800/SP1200

Šifra	Opis	Cena
5050440	Spa Maestralne dimenzije: 5800x2200x1200 mm	37.909,00 €
5050492	Sivi tvrdi poklopac	1.500,00 €
5050493	Tvrđi poklopac kafeni	1.500,00 €



Model	* Potrošnja kW	Isporučeni uređaji	Količina	Potrošnja kW/h
SPA MISTRAL	8,8	Hidromasažna pumpa od 2 KS	1	1,5
		Pumpa od 3 KS	3	2.2 svaki
		Cirkulaciona pumpa	2	0.37svaki
		Kompresor	1	0,4
		Kontrolna tabla zone relax	1	3
		Kontrolna ploča fitness	1	3,5
Generator ozona	2	0,01		
LED lampa	2	0,01		

*Maksimalna nominalna potrošnja u radnim uslovima

TEHNIČKE SPECIFIKACIJE

MODEL SPA

REGINA* ORTENSIA ORCHIDEA MAGNOLIA MAJOR VALENTINA ROKA CRISTAL IMPERIAL MISTRAL ATOLLO***

Neto težina	[kg]	312	285	335	312	403	280	360	390	1100	1100	105
Volumen vode	[M3]	1,5	1,1	1,6	1,5	1,8	1,2	1,9	1,8	4,7	5,0	1,1
CIRKULACIONAPUMPA												
Snaga	[kW]	0,37	0,37	0,37	0,37	•	0,37	•	•	0,37	0,37 (x 2)	0,15
Amperaža	[A]	2,0	2,0	2,0	2,0	•	2,0	•	•	2,0	2,0	1,14
HIDROMASAŽNA PUMPA												
Pumpa n°1												
Vrsta	-	1 brzina	1 brzina	1 brzina	1 brzina	2 brzine	1 brzina	2 brzine	2 brzine	1 brzina	1 brzina	-
Snaga	[kW]	1,5	2,2	1,5	1,5	0.4/1.85	1,5	0.4/1.85	0.4/1.85	2,2	2,2	-
Amperaža	[A]	7,0	10,0	7,0	7,0	2.5 / 9,0	7,0	2.5 / 9,0	2.5 / 9,0	10	10,0	-
Pumpa n°2												
Vrsta	-	1 brzina	-	1 brzina	1 brzina	1 brzina	1 brzina	1 brzina	1 brzina	1 brzina	1 brzina	-
Snaga	[kW]	1,5	-	1,5	1,5	1,5	1,5	2,2	2,2	2,2	1,5	-
Amperaža	[A]	7,0	-	7,0	7,0	7,0	7	10	10	10	7,0	-
Pumpa n°3												
Vrsta	-	-	-	-	-	1 brzina	-	1 brzina	1 brzina	1 brzina	1 brzina	-
Snaga	[kW]	-	-	-	-	1,5	-	2,2	2,2	2,2	2.2 (X 2)	-
Amperaža	[A]	-	-	-	-	7,0	-	10	10	10	10,0	-
KOMPRESOR												
Vrsta	-	1 brzina	1 brzina	1 brzina	1 brzina	1 brzina	1 brzina	1 brzina	1 brzina	-	1 brzina	1 brzina
Snaga	[kW]	0,7	0,4	0,4	0,7	0,4	0,4	0,4	0,4	-	0,4	0,9
Amperaža	[A]	2,8	2,8	2,8	2,8	2,8	2,8	2,8	2,8	-	2,8	3,9
RASVETA												
Vrsta	-	RGB LED	RGB LED	RGB LED	RGB LED	RGB LED	RGB LED	RGB LED	RGB LED	RGB LED	RGB LED	-
Snaga	[W]	7,5	7,5	7,5	7,5	7,5	7,5	7,5	7,5	7,5	7,5	-
Amperaža	[A]	0,625	0,625	0,625	0,625	0,625	0,625	0,625	0,625	0,625	0,625	-
KOMANDNI SISTEM												
Vrsta	-	SP800	SP800	SP800	SP800	SP1200	SP800	SP1200	SP1200	SP1200	SP800/ SP1200	AT01
Snaga grejanja	[kW]	3,0	3,0	3,0	3,0	3,5	3,0	3,5	3,5	3,5	3,0/3,5	1,5
Amperaža	[A]	13,0	13,0	13,0	13,0	15,2	13,0	15,2	15,2	16	13,0/15,2	6,6
Električna energija	[V]	230	230	230	230	230	230	230	230	400	400	230
OZONSKI MOD.												
Potenza	[W]	10,0	10,0	10,0	10,0	10,0	10,0	10,0	10,0	10,0	10,0	-
Amperaža	[A]	0,1	0,1	0,1	0,1	0,1	0,1	0,1	0,1	0,1	0,1	-
Aroma terapija	-	Da/Da	Da/Da	Da/Da	Da/Da	Da/Da	Da/Da	Da/Da	Da/Da	Da/Da	Da/Da	-
POTROŠNJA **												
Minimalna potrošnja energije	[kW]	3,4	3,4	3,4	3,4	3,9	3,4	3,9	3,9	3,7	3,4 / 3,9	0,2
Maksimalna potrošnja energije	[kW]	3,8	3,5	3,5	3,8	5,3	3,5	6,85	6,85	6,7	2,1 / 6,7	2,5
Potreban je magnetnotermički prekidač	[A]	20	20	20	20	25	20	32	32	32	20 / 32	16
MLAZNICE												
Ukupan broj mlaznica vode	[n°]	34	29	49	34	58	46	84	60	44	58	1
Fiksni mlaz	[n°]	25	7	30	25	30	40	-	34	8	40	1
Rotaciona mlaznica	[n°]	9	22	19	9	28	6	-	26	36	18	-
Ukupan broj zračnih mlaznica	[n°]	22	10	14	22	10	10	8	10	-	16	8
Protivstrujno plivanje	-	Ne	Ne	Ne	Ne	Ne	Ne	Ne	Ne	Da/Da	Da/Da	-

* Verzija s integrisanom filtracijom ** Maksimalna nominalna potrošnja u radu ***Verzija mehurića

POLLUX UGRADNI



Karakteristike	Opis
Volumen vode	2100 l
Težina prazne	220 kg
Spoljne dimenzije	299 x 249 cm
Visina	111 ± 2 cm
Sedišta	7
Recirkulacija vode na prelivu	Da
Mlaznice vodene i zračne	Da



Beli Mlaznice od nerđajućeg čelika standardne

Šifra	Opis	Cena
	Pollux je unapred opremljen hidromasažnim mlaznicama i distribucijom hidrauličkog kola	
5050520	POLLUX 300 bela	20.097,00 €
	Pollux prelivni opremljen kompletom peščanog filtera i odlivnom kadom	
5050522	POLLUX 300 bela	29.948,00 €



Tehnički podaci	Br.	Isporučeni uređaji*	Količina
Masažni mlaz vode (podesiv i prilagodljiv protoku)	13	Filtraciona pumpa od 0,5HP 1~	1
Usisavanje protiv vrtloga	4	Filter za pesak Ø650 mm	1
Pražnjenje dna	4	Kompensacioni rezervoar dimenzije / Ø1000 x h1460 mm	1
Usis prelivne ivice	2	3HP 1~ Hidromasažna pumpa /	1
Regulatori protoka vazduha	4	940W 1~ kompresor	1
Podesive noge (-/+ 20 mm)	Da	Električna tabla 3 kW 1~	1

*Trofazno napajanje na zahtev

JULIA 250 UGRADNA



Karakteristike	Opis
Volumen vode	1100 l
Težina prazne	180 kg
Spoljne dimenzije	Ø 249 cm
Visina	108 ± 2cm
Sedišta	5
Recirkulacija vode na prelivnoj ivici	Da
<hr/>	
Vodne i vazdušne mlaznice	Da



Beli



Mlaznice od nerđajućeg čelika standardne

Šifra	Opis	Cena
	Prelivna Julia unapred opremljen hidromasažnim mlaznicama i distribucijom hidrauličkog kola	
5050540	JULIA 250 bianco / JULIA 250 bijela	16.236,00 €
	Julia s filtriranjem pijeska i kompletom spremnika za ravnotežu	
5050542	JULIA 250 bianco / JULIA 250 bijela	24.812,00 €

Tehnički podaci	n°	Isporučena oprema*	Količina
Masažni mlaz vode (podesiv i upravljiv prema protoku)	6	Filtraciona pumpa od 0,5HP 1~	1



Usisavanje protiv virno	4	Filter za pesak Ø500 mm	1
Ispust dna	4	Kompenzacioni rezervoar Ø1000 x h1460 mm	1
Usisavanje prelivne ivice	2	3HP 1~ Hidromasažna pumpa	1
Regulatori protoka zraka	4	940W 1~ Kompresor	1
Podesive noge +/- 20 mm	Da	Električna tabla 3 kW 1~	1

FILTER ULOŠCI



Šifra.600-10754



Šifra.600-10767



Šifra.600-10398



Šifra.600-12746

Modeli / Tip: Orchidea, Major, Valentina, Dama, Dalia, Cristal, Formula, Iris H.P.110, Maestral, Blue Vision, Liberty SPA

Šifra	Opis	Cena
600-10754	Uložak za skimmer h 20,5 cm, navoj 20,5 cm Øext15cm, navoj 2,3 cm	36,00 €

Modela/ Tip: Kraljica, hortenzija i magnolija

Šifra	Opis	Cena
600-10767	Uložak za plutajući skimmer h.33 cm, Ø ext12,50 cm Ø int 5,5 cm	32,00 €

Modeli / Tip: Roka

Šifra	Opis	Cena
600-10398	Uložak za plutajući skimmer h.34,7 cm, Ø ext 13 cm Ø int 5,9 cm	44,00 €

Modeli / Tip: YUI

Šifra	Opis	Cena
Telefon 600-12746	Uložak za skimer h.21,6 cm, Ø ext 12,7 cm	73,70 €
8200210	Uložak za skimer s navojem ženskim h.34,8 cm, Øest 12,4 cm -Yui od 2021	40,30 €

AROMATERAPIJA I ESENCIJE

Novo mirisno iskustvo dostupno je za Spa opremljene kompresorom. Vazdušni mehurići izlaze se na površinu Spa, pospešujući efekat opuštajućeg uživanja. Kutija od 4 esencije sadrži: esenciju kamilice, smirujući učinak / opuštajući efekat lavande / energetski učinak eukaliptusa / romantični efekat ruže.



Šifra.5050621



šifra.5020261 - 5020323



Šifra.5020360 - 5020363

Šifre	Opis	Cena
5050621	Aromaterapijska kutija s 4 esencije u sferama	149,60 €

TEČNE ESENCIJE

Preporučena doza: 5 ml po 1 m³ / Preporučena doza: 5 ml po 1 m³

5020261	Esencija kokosove vanile 1 l	139,00 €
5020262	Esencija limunske trave 1 l	139,00 €
5020263	Esencija planinskog bora 1 l	139,00 €
5020264	Esencija eukaliptusa 1 l	139,00 €
5020320	Esencija kokosove vanile 250 ml	30,00 €
5020321	Esencija limunske trave 250 ml	30,00 €
5020322	Esencija planinskog bora 250 ml	30,00 €
5020323	Esencija eukaliptusa 250 ml	30,00 €
5020360	Esencija divljeg cveća	13,50 €
5020361	Esencija breskve	13,50 €
5020362	Esencija lavande	13,50 €
5020363	Esencija eukaliptusa	13,50 €

TRETMANSKI PROIZVODI

Asortiman proizvoda posebno dizajniranih za spa tretmane i čišćenje

Šifra	Opis	kg/l	Cena
9030111	Algicid	1 l	9,40 €
9030112	Brom tablete sporo otapajuće 20 gr	1 kg	40,80 €
9030113	granulirani PH minus	1,5 kg	8,80 €
9030114	Tablete hlora za sporo otapanje 20 gr	1 kg	24,50 €
9030115	Sredstvo protiv pene	1 l	14,40 €
9030116	Gel za odmašćivanje	1 l	12,40 €
9030117	Odstranjivač kamenca	1 l	16,30 €
9030118	Održavajuće Sredstvo za čišćenje i odmašćivanje	1 l	7,60 €
9030119	Uklanjanje kamenca za cevi	1 l	20,60 €

PROJEKTI WELLNESS CENTARA



▲ iznad/Gore

Wellness centar:

Kabina tursko kupatilo šifra: 5010100
 Kabina prof. sauna šifra 5020352
 Spa Ortensia šifra 5050458
 Rubino tuš kabina šifra 5010021
 Tropske kapi i hladan vetrić šifra 5010034

▶ sa strane

Wellness centar:

Kabina tursko kupatilo 5010100
 Kabina profesionalna sauna 5020296
 Spa Ortensia 5050458
 Tropske kapi i hladni vetrić 5010034



PROJEKTI WELLNESS CENTARA

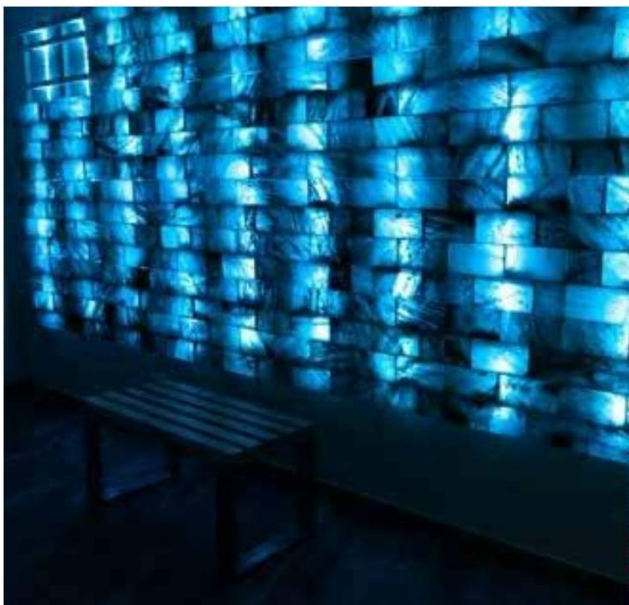



SAUNE FINŠKE NA INFRACRVENIM - INFRARED AND FINNISH SAUNAS



REGINA

KARAKTERISTIKE | Features

materijal čamovo drvo
material masiv

dimenzije 144x108x204 cm
dimension 156x132x204 cm
dimension 188x144x204 cm
dimension 204x156x204 cm



2 ležaljke
2 benches



ARIA

KARAKTERISTIKE | Features

materijal drvo Hemlock
material canadese

dimenzije 120x120x200 cm
dimension 150x130x200 cm
dimension 180x130x200 cm



2 ležaljke
2 benches



GLORIA

KARAKTERISTIKE | Features

materijal drvo Hemlock
material canadese

dimenzije 90x90,4xh190 cm
dimension 120x90,4xh190 cm



1 ležaljka
1 bench



GIADA

KARAKTERISTIKE | Features

materijal legno Hemlock
material canadese

dimenzije 150x120xh190cm
dimension 180x120xh190cm



1 ležaljka
1 bench



LUNA

KARAKTERISTIKE | Features

materijal čamovo drvo
material

dimenzije 126x126xh190 cm
dimension



1 ležaljka
1 bench



SOLE

KARAKTERISTIKE | Features

materijal čamovo drvo
material

dimenzije 90x160xh190 cm
dimension 180x150xh190 cm



2 stolice
2 chairs

VRTNE SAUNE



LEA

KARAKTERISTIKE

Materijal Unutrašnje opremanje od lipa

Dimenzije 3210x 2835 mm

Isporuksa s terasom



3 klupe



OTTAVIA

KARAKTERISTIKE

Materijal Unutarnja oprema od lipa

Dimenzije 4070x 2835 mm

Isporuksa s terasom



3 klupe

BAČVASTE SAUNE



KARAKTERISTIKE

Materijal: Smreka i unutrašnja obloga lipa

dimenzije Ø220 x 180



2 klupe



KARAKTERISTIKE

Materijal: Smreka i unutrašnja obloga lipa

Dimenzije Ø220 x 220



2 klupe

Toplina nam može pomoći da se osećamo zdravije. Nije važno dali odaberete saunu ili infracrvenu kabinu. Umirujuća toplina može ojačati vaš imunološki sistem, podići raspoloženje, opustiti mišiće, poboljšati izgled kože i učiniti još mnogo toga.

Ambijent saune deluje kao savršeno protivstressno sredstvo za stres i preopterećenje informacijama. Fizičko i mentalno opuštanje.



FINSKE SAUNE



Finska sauna ili "suva sauna" originalna je sauna u kojoj temperatura može postignuti 80-100 °C, izazivajući obilno znojenje kože, dok vlažnost ne prelazi 10-20%. U vodu se mogu dodati eterična ulja s balzamičnim svojstvom, kao što su bor ili eukaliptus. Obično, praksa saune predviđa naizmeničn provoditi minute u sauna pa kupke u hladnoj vodi ili hladne tuševe. Prednosti koje se mogu dobiti redovitom upotrebom saune su bezbrojne, a ne samo na fizičkom nivou. Najneposrednija korist koju dobijate od saune je ublažavanje nervne napetosti i opšte opuštanje; Obavijajuća toplina saune opušta mišiće i zglobove; obilno znojenje uklanja nečistoće i uklanja sloj mrtvih ćelija kože; redovitom upotrebom saune poboljšava se tonus i elastičnost kože poboljšava i postaje glađa i svjetlija.

SAUNE NAINFRACRVENE ZRAKE

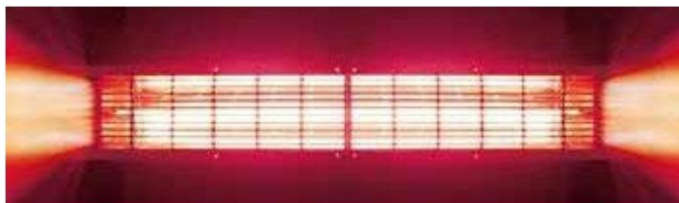

Infracrvena sauna pruža mnoge zdravstvene prednosti zbog prirodne sunčeve svjetlosti, ali BEZ opasnog učinka sunčevih zraka. Infracrveni zraci proizvode toplinu i nemaju nikakve veze s ultraljubičastim zracima (zraci od kojih se crni) koji su vrlo štetni za kožu. Područja primene zdravih infracrvenih zrakova su najrazličitija, ali ono što najviše potvrđuje blagotvornost učinka istih je zapaziti da u dečijim bolnicama inkubatori zagrevaju malu novorođenčad baš infracrvenim zracima.

SAUNA FINSKA REGINA / REGINA FINNISH SAUNA



- Kabina izrađena od masivnog drveta jele KVALITET B/C
- 2/3 fronta od providnog stakla
- Moontaža sa multiclip (ne vidi se vijak)
- Šarka 3308 polukružna
- Unutrašnja ručka od drveta i spoljna od čelika
- 3 vidljive strane
- Straklo se može montirati levo i desno

Enterijer "Prestige" od drveta lipe:
2 klupe; 1 naslon za glavu; ventilacioni prorez;
Naslon za kičmu; srednji panel klupe; zaštitna rešetka peći;
lampa sa srvenom zaštitom, bez sijalice.

Peć nije obuhvaćena.

- Cabin made of solid fir wood. QUALITY B/C
- 2/3 transparent glass front
- Multiclip assembly (screw not visible)
- Semi-round hinge 3308
- Internal handle in wood and external in steel
- 3 visible sides
- Glass can be mounted on the right or left

"Prestige" interior in lime wood:
2 benches; 1 headrest; ventilation slot; backrest;
intermediate bench panel; stove protection grill;
lamp with wooden protection, without bulb.
Stove not included.

Šifra/code	Opis /description	Dimenzije/size	cena/price
5020596	Sauna tradicionalna Regina 14	144x108x204 cm	5.109,00 €
5020597	Sauna tradicionalna Regina 15	156x132x204 cm	5.643,00 €
5020598	Sauna tradicionalna Regina 18	188x144x204 cm	6.716,00 €
5020599	Sauna tradicionalna Regina 20	204x156x204 cm	7.229,00 €

ARIA FINSKA SAUNA / ARIA FINNISH SAUNA

NEW



- Kabina izrađena od Hemlock kanadskog drveta
- Vrata od tempiranog providnog stakla
- Peć sa ugrađenim komandama i zaštitnom rešetkom
- Komplet sa opremom: kamenje, kanta, kutlača, termohigrometar i sat
- Radio FM/MP3
- Svetlo LED

Enterijer od drveta:
2 klupe; 1 naslon za leđa.

- Cabin made of Canadian Hemlock wood
- Transparent tempered glass door
- Stove with integrated controls and protective grill
- Complete with accessories: stones, bucket, ladle, thermo-hygrometer and hourglass
- FM/MP3 radio
- LED light

Wooden interior:
2 benches; 1 backrest.

Šifra/code	Opis /description	Dimenzije/size	Cena/price
5020565	Sauna tradizionale Aria 120	120x120x200h cm	2.354,90 €
5020574	Sauna tradizionale Aria 150	150x130x200h cm	2.869,90 €
5020573	Sauna tradizionale Aria 180	180x130x200h cm	3.444,90 €

UGAONA SAUNA NA INFRACRVENIM LUNA / CORNER LUNA INFRARED SAUNA

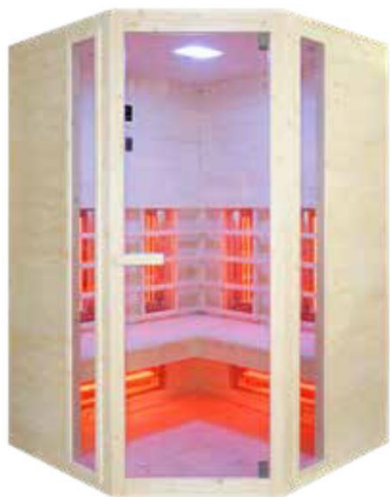

- Ugaona kabina izrađena od drveta jelovine
- Dimenzija: 126x126xh190 cm
- Kontrolni panel
- Vrata i stakla od providnog tempiranog stakla
- Drvene ručke
- Rasveta 1 svetlo led + 7 boja
- Halogeni grejači na infracrvene
- MP3 con Bluetooth

Interni "Prestige" in legno:

1 panca; 1 poggiaschiene; lampade alogene direzionate su schiena e polpacci.

- Corner cabin made of fir wood
- Dimensions: 126x126xh190 cm
- Control panel
- Transparent tempered glass door and windows
- Wooden handle
- Illumination 1 led light + 7 colors
- Infrared halogen heaters
- MP3 with Bluetooth

Wooden "Prestige" interior:

1 bench; 1 backrest; halogen lamps directed on back and calves.

Šifra/code	Opis/description	Dimenzije/size	Cena/price
5020575	Sauna infrarossi angolare LUNA	126x126xh190 cm	2.427,40 €

SAUNA na infracrvene GLORIA / GLORIA INFRARED SAUNA



- Dimenzije: 90x90,4xh190 cm e 120x90,4xh190 cm
- Za jednu osobu
- Drvo hemlock
- Opremlenost: grejač od keramike, digitalni kontrolni panel, čitač MP3 + radio FM sa kutijama + bluetooth
- Svetlo LED
- Potrošnja 1550W/230V
- Dimensions 90x90,4xh.190 cm
- For 1 person
- In hemlock wood
- Equipment: ceramic heater, digital control panel, MP3 player and radio with speakers, bluetooth
- LED light
- Power consumption 1550W/230V

Šifra/code	Opis/description	Dimenzije/size	Cena/price
5020560	Kabina Gloria 90	90x90,4xh190 cm	1.584,90 €
5020561	Kabina Gloria 120	120x90,4xh190 cm	1.779,90 €

SAUNA NA INFRACRVENE GIADA / GIADA INFRARED SAUNA



- Dimenzije 150x120x190 cm (za tri osobe)
180x120x190 cm (za 3/4 osobe)
- Od drveta hemlock
- Oprema: keramički i karbonski grejač, digitalni kontrolni panel, čitač MP3 + radio FM sa kutijama + bluetooth
- svetlo LED
- Potrošnja 2690W/230V
- Dimensions 150x120x190 cm (for 3 people)
180x120x190 cm (for 3/4 people)
- In hemlock wood
- Equipment: ceramic and carbon heater, digital control panel, MP3 player and radio with speakers, bluetooth
- LED light
- Power consumption 2690W/230V

Šifra/code	Opis/description	Dimenzije/size	Cena/price
5020563	Kabina Giada 150	150x120x190	2.781,00 €
5020564	Kabina Giada 180	180x120x190 cm	3.416,70 €

SAUNA NA INFRACRVENIM SOLE/ SOLE INFRARED SAUNA

NEW



- Kabina izrađena u čamovini
- Kontrolni panel
- Vrata i staklenik od providnog tempiranog stakla
- Drvena ručka
- Rasveta 1 svetlo led
- Hladnjaci na infracrvene karbonium + halogeni
- MP3 sa Bluetooth

Enterijeri "Prestige" od drveta:
1 sedia (Sole 100), 2 sedie (Sole 180).

- Cabin made of fir wood
- Control panel
- Door and glazing made of clear tempered glass
- Wooden handle
- Illumination 1 led light
- Infrared carbon + halogen radiators
- MP3 with Bluetooth

Wooden "Prestige" interior:
1 chair (Sole 100), 2 chairs (Sole 180).



Šifra/code	Opis/description	Dimenzije size	Cena/price
5020576	Sauna infracrveni SOLE 100	90x160x190 cm	2.958,80 €
5020577	Sauna infracrveni SOLE 180	180x150x190 cm	4.083,50 €

PROFESIONALNE SAUNE



Struktura u lamperija panelima s izolacijskim međuprostorom u kamenoj vuni i aluminijskoj foliji, debljine rama cca 7,2x4,6 cm, prekrivena s obe strane lamperijom. Velika vrata izrađena od bronзанog i kaljenog stakla debljine 8 mm sa oblogama za zaptivanje.

Pod rešetkasti po celoj površini.

Zajedno s: peći s daljinskim upravljačem, pločom izvan kabine, sa lampom abažurum, peščanim satom, termo-higrometrom, kantom s varjačom i naslonom za glavu.

Fina završna obrada u severnoj smreki.

Pravougaoni oblik i po meri.

Po želji je moguće dostaviti prozor po meri.

Ostali dostupni modeli - Mogućnost izrade drvenih zidova u kanadskoj čamovini i Termo-blistača bukve

Šifra	Opis	Spoljne dimenzije [mm]			Peć [kW]	Cena
		širina	dubina	visina		
5020355	Profesionalna sauna nordijske smreke*	1500	1200	2100	3,5	8.577,00 €
5020350	Profesionalna sauna nordijske smreke	1500	1500	2100	4,5	10.684,00 €
5020351	Profesionalna sauna nordijske smreke	2000	1500	2100	4,5	12.334,00 €
5020294	Profesionalna sauna nordijske smreke	1800	1200	2100	4,5	10.684,00 €
5020352	Profesionalna sauna nordijske smreke	1800	1600	2100	4,5	12.004,00 €
5020295	Profesionalna sauna nordijske smreke	2000	1350	2100	4,5	11.773,00 €
5020296	Profesionalna sauna nordijske smreke	2000	2000	2100	6	14.174,00 €
5020297	Profesionalna sauna nordijske smreke	2500	2000	2100	8	€16,059,00
5020356	Profesionalna sauna nordijske smreke	2500	2500	2100	9	€19,620,00
5020353	Profesionalna sauna nordijske smreke	3000	2000	2100	9	€19,620,00
5020354	Profesionalna sauna nordijske smreke	3000	2500	2100	11	21.691,00 €
5020357	Profesionalna sauna nordijske smreke	3000	3000	2350	15	27.718,00 €
5020358	Profesionalna sauna nordijske smreke	3500	3000	2350	20	32.355,00 €

*peć s ugrađenom komandom

Slike služe samo u ilustrativne svrhe



Slike imaju samo ilustracijske svrhe

SAUNA BAŠTENSKA
SAUNA FOR GARDEN



- Dimenzije kabine 2030x2030 mm. Dimenzije na zemlji 3210x2835 mm
- Sa terasom
- Grede sa Blockhaus od masivne jele da 40 mm
- Temejni impregnirani ram
- Fiskni staklenik od izolirnog stakla (1587 x 506 x 16 mm)
- Drvena vrata sa staklom i brava spolja

Oprema enterijera od lipe:

- 2 klupe širine 600 mm, 1 široka klupa 500 mm
- 2 naslon za glavu
- 2 naslona
- lampa con sa zaštitom sijalice
- Bez peći.

- Cabin dimensions 2030x2030 mm. Floor space 3210x2835 mm
- With terrace
- 40 mm solid spruce beams for Blockhaus
- Impregnated base frame
- Fixed glazing in insulated glass (1587 x 506 x 16 mm)
- Wooden door with glass and lock on the outside

Interior decoration in linden:

- 2 benches 600 mm wide, 1 bench 500 mm wide
- 2 headrests
- 2 backrests
- lamp with protection lamp without bulb
- Stove not included.

- Dimenzije kabine 4070x2030 mm. Gabarit na tlu 4070x2835 mm
- Sa terasom
- Grede za Blockhaus od masivne čamovine od 40 mm
- Ram temeljni impregnirani
- Fiksna izolir stakla (1587 x 506 x 16 mm)
- Drvena vrata sa staklom ESG i spoljna brava

Unutrašnje uređenje od lipe:

- 2 klupe široke 600 mm, 1 klupa larga 500 mm
- 2 naslona za glavu
- 2 naslona za leđa
- Lampa sa zaštitom bez sijalice
- Bez peći

- Cabin dimensions 4070x2030 mm. Footprint 4070x2835 mm
- With terrace
- 40 mm solid spruce beams for Blockhaus
- Impregnated base frame
- Fixed glazing in insulated glass (1587 x 506 x 16 mm)
- Wooden door with ESG glass and lock on the outside

Interior decoration in linden:

- 2 benches 600 mm wide, 1 bench 500 mm wide
- 2 headrests
- 2 backrests
- lamp with protection lamp without bulb
- Stove not included.

Šifra/code	Opis/description	Cena/price
5 020590	Sauna baštenska Lea	15.264,00 €
5 020591	Sauna baštenska Ottavia	15.264,00 €

BAČVA SAUNE

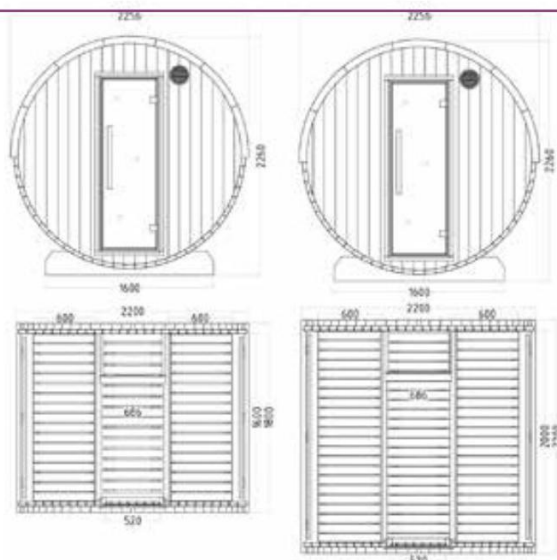

Šifra 5020592

Šifra.5020593

Oprema:

- Bačva sauna od smreke, letvice od 40 mm
 - Unutrašnjost od lipe
 - Klupe 2 x 600 mm
 - 2 naslona za leđa
 - LED traka bijelog svjetla, zatamnjena, 760 mm
 - Krovni pokrivač uključen - crni bitumenske crep
 - Dvodelni podne rešetke
 - Rešetka za zaštitu peći
- Pogodno za električne peći i peći na drva
 - 8mm sigurnosna jednostruka staklena vrata

Model	180	220
Dimenzije (cm)	Ø220 x 180 Ø220 x 220	
Debljina zida(mm)	40	
Vrsta drva	Smreka	Smreka
Završna obrada enterijera	Lipa	Lipa
Dimenzije vrata (mm)	520 x 1620 x 80	520 x 1620 x 80
Zaštita od sigurnosti peći (mm)	570 x 390	570 x 390
Podna rešetka (mm)	1590 x 595	1970x595
Dužina kabine	160	200
Jačina zvuka [m ³]	5,6	7
osobe	Do 4/do 4	Do 6/do 6

Šifra	Opis	Cena
5020592	Bačvasta vrtna sauna Ø220 - 180 dužine	9.415,00 €
5020593	Bačvasta vrtna sauna Ø220 - 220 dužine	10.255,00 €



PRIBOR ZA BAČVASTE SAUNE

Šifra	Opis	Cena
5020380	Peć za bačvastu saunu S2 16,5 Kw (bez kamenja)	1.120,90 €
5020381	Trostrana zaštita peći WL450	553,70 €
5020382	WL100 / WL100 zaštita poda	536,80 €
5020383	Kamin čelik inox WHP1500	€1,174,90

ESENCIJE ESSENCES

Esencija proizvedena sa prirodnim eteričnim uljima. Približno preporučeno doziranje: 5 ml/L vode
Essence made with natural essential oils. Recommended dosage: approximately 5 ml/L water



Šifra/code	Opis/description	Cena/price
5020249	Esencija kiselog voća 250 ml / Citrus essence 250 ml	31,10 €
5020251	Esencija lim.kis. 250 ml/ Lemongrass essence 250 ml	31,10 €
5020252	Esencija lavande 250 ml/ Lavender essence 250 ml	31,10 €
5020253	Esencija planinskog bora 250 ml / Mountain Pine essence 250 ml	31,10 €
5020254	Esencijaa jelovine 250 ml/ Pine essence 250 ml	31,10 €
5020255	Esencija mentola 250 ml / Peppermint essence 250 ml	31,10 €
5020256	Esencija eucaliptusa 250 ml / Eucalyptus essence 250 ml	31,10 €
5020257	Esencija zimski san 250 ml / Winter dream essence 250 ml (cannella, arancio, anice, chiodi di garofano / cinnamon, orange, anise, cloves)	31,10 €
5020260	Esencijaa breza 250 ml / Birch essence 250 ml	31,10 €
5020299	Esencija matičnjak 250ml/ Melissa essence 250 ml	31,10 €
5020280	Esencijaa Mentol 5 l/ Mint essence 5 l	51,30 €

KANTE FLOODS

Kanta za infuziju 5020271 : Borovo drvo sa plastičnim umetkom da 5 l cca. Povezan sa sa 2 pocinkovana gvozdena kruga trakasta. Dimenzije 240x195 mm

Kanta za tuširanje 5020330 : od tvrdog drveta Ariša, obložen iznutra i spolja sa nepromočivom farbom i nosačem od inox čelika.za montažu na zid i plafon. Dimenzije kante 305x270 mm, dimenzije nosača 350x100x350 mm

Infusion bucket 5020271 : made of pine wood with plastic insert, 5 l approx. Tied with 2 galvanized band-iron hoops. Dimensions 240x195 mm.

Flood shower bucket 5020330 : made of robust larch wood, inside and outside coated with watertight varnish. Holder made from stainless steel for wall or ceiling assembly. Dimensions bucket 305x270 mm, dim. holder 350x100x350 mm.



cod.5020271



cod.5020286



cod.5020330

Šifra/code	Opis/description	Cena/price
5020330	Drvena kanta anša za kupanje sa nosačem / Larch wood shower bucket with stand	967,50 €
5020271	Borova drvena kanta / Pine wood bucket	75,20 €
5020233	Drvena kutlača 40 cm / Wooden ladle 40 cm	22,50 €
5020286	Velika drvena kutlača 80 cm / Big wooden ladle 80 cm	171,00 €

ACCESSORI VARI
VARIOUS ACCESSORIES

Codice /code	Descrizione /description	Prezzo/price
5020277	Clessidra sabbia rossa 15 minuti / Hourglass red sand 15 minutes	24,10 €
5020388	Termo-igrometro / Thermo-hygrometer	40,30 €
5020248	Termometro / Thermometer	34,90 €
5020239	Lampada per sauna con cupola di vetro smerigliato / Lamp for sauna with frosted glass dome	82,80 €
5020237	Paralume per sauna / Shade for sauna	54,00 €



cod.5020277



cod.5020388



cod.5020248



cod.5020239



cod.5020237

Codice /code	Descrizione /description	Prezzo/price
5020230	Pietre per stufa - confezione da 20 Kg / Stones for stove - 20 Kg pack	56,00 €
5020231	Poggia-testa o piedi 400x310x85 / Head for foot-rest 400x310x85	57,60 €
5020232	Schienale ergonomico in legno / Wooden ergonomic back	112,10 €



cod.5020230



cod.5020231



cod.5020232

AM PEĆI ZA SAUNE



- Gornji premaz ojačan teflonom kako bi se sprečila deformacija tela na visokim temperaturama.
- Sigurnosni uređaj za visoke temperature.

AM PEĆ S INTEGRISANIM UPRAVLJANJEM

- Mehaničko upravljanje grejačem.
- Maksimalno 4 sata zagrevanja plus 8 sati čekanja.

AM PEĆ Sa SPOLJNIM UPRAVLJANJEM

- Digitalni kontroler za prikaz vremena i temperature
- Digitalni senzor temperature za precizno upravljanje
-bez mehaničke kontrole grejača

Šifre	Opis	Cena
Sa INTEGRISANOM KONTROLOM		
5020368	Peć AM 3 kW/230 V - Štednjak AM 3 kW/230 V	387,50 €
5020369	Peć AM 4,5 kW/230 V - Štednjak AM 4,5 kW/230 V	388,00 €
5020370	Peć AM 4,5 kW/400 V - Štednjak AM 4,5 kW/400 V	388,00 €
S VANJSKOM KONTROLOM		
5020371	Peć AM 4,5 kW/400 V - Štednjak s vanjskim upravljanjem 4,5 kW/400 V	522,90 €
5020372	Peć AM 6 kW/400 V - Štednjak s vanjskim upravljanjem 6 kW/400 V	541,50 €
PRIBOR		
5020230	Kamenje peći	56,00 €

VEGA COMPACT



Peć s integrisanim komandama. Isporučena količina kamena 12 kg. Za saune od 1,3 do 4,5 m³.

Šifre	Opis	Cena
5020313	Vega kompaktna peć 3,5 kW 230/400 V	794,00 €

MODERNA CRNA



Obuhvaćen isporukom spoljna digitalna kontrola, spoljno kućište od crnog čelika. Isporučena kamena količina 20 kg. Za saune od 3,0 do 12 m³.

Šifre	Opis	Cena
5020314	Moderna peć 4,5 kW 230/400 V	€1,964,00
5020315	Moderna peć 6,0 kW 230/400 V	1.996,00 €
5020316	Moderna peć 8,0 kW 230/400 V	2.086,00 €

KIVI



Akumulaciona peć u obliku piramide s izloženim kamenjem u kavezu.
Digitalna kontrola, kameni kapacitet isporučeni 100 kg. Za saune od 6,0 do 14m³

Šifre	Opis	Cena
5020317	Akumulaciona peć Kivi 6,9 kW 230/400 V	3.684,00 €
5020318	Akumulaciona peć Kivi 9 kW 230/400 V	3.970,00 €

PRO



Za tradicionalne finske saune na drva za unutrašnju i spoljnu upotrebu. Peć se isporučuje s 40 kg peridotitnog kamenja. Za saune od 8 do 20 m³.

Šifre	Opis/opis	Cena
5020319	Peć na sagorevanje drva ES PRO -aparatus za prokuvavanje za vodu 20 l	3.132,00 €

PEĆI SERIJE COMBI ZA BIO SAUNE

DELTA COMBI

TOPKLASA COMBI



Topclass combi

Bio sauna je moderna alternativa tradicionalnoj sauni, s maksimalnom temperaturom od oko 50/60 °C i postotkom vlage reda od 60/70%.
Peći serije Combi opremljene su integriranim generatorom pare i kamenjem.
DELTA COMBI za saune od 1,3 - 2,5 m³, TOPCLASS spremnik od 2 litre za saune od 5-8/8-14 m³, spremnik od 5,5 litara
CLUB COMBI za saune 11 - 20 m³, spremnik od 5,5 li

Šifre	Opis	Cena
5020364	DELTA COMBI peć bez kontrole	2,9 kW 230/400 V 1.786,00 €
5020365	Peć TOPCLASS COMBI 60 kontrola isključivo	6,0 kW 400 V 2.250,00 €
5020366	Peć TOPCLASS COMBI 90 bez kontrole	9,0 kW 400 V 2.338,00 €
5020367	CLUB COMBI peć bez kontrole	13,5 kW 400 V 2.824,00 €

Delta combi



KLUB COMBI

DIGITALNA KONTROLA



Digitalni kontrolni mod. "Xenio" (plug & go) + pogonska jedinica (kućište od nehrđajućeg čelika s prekidačem i ožičenjem na ploči napajanja

Šifre	Opis	Cena
5020374	Kontrola peći od 2,3 do 11,0 kW	1.260,00 €
5020375	Kontrola peći od 2,3 do 17,0 kW	1.532,00 €
5020376	Upravljanje bio-pećima COMBI serija	€1,786,00
5020377	Upravljanje finfracrvenim sistemom	1.258,00 €

HAMAM TURSKO KUPATILO

Princip i vrline turskog kupatila slični su onima jedne saune. Međutim, to je vlažna i umerena toplota koja se preporučuje za celu familiju, uključujući i decu.

Suva toplina saune je između 70 °C i 100 °C, dok je toplina parnog kupatila između 40 °C i 50 °C. Glavna karakteristika turskog kupatila je stvoriti okruženje s vlagom od 98% koje garantuje potrebne uslove za parno kupanje na temperaturama blizu 50 stepeni.

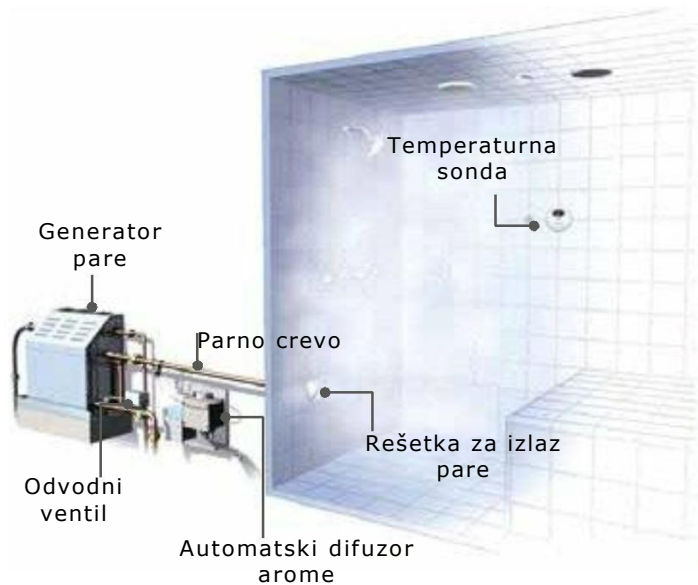

Pravougaona kabina

Automatsko uklanjanje iz memorije

- Ocedite generator nakon svake upotrebe, kako biste proizveli čistu paru, obnavljajući vodu pre svake upotrebe.
- Poboljšava performanse i produljuje vek trajanja generatora pare.
- Jednostavno za povezivanje.

Automatski difuzor arome

- Automatski uvodi eterična ulja u parnu cev.
- Kanister od 5 litara za duži vek trajanja.
- Izbor 5 aromatičnih ulja.
- Kontrolni prekidač spolja postavljen.

KABINE TURSKOG KUPATILA OD EPS

Komplet za strukturu u EPS panelima

- Generator pare s upravljačkom pločom i temperaturnom sondom
- Obrani kaput, lateks i vlakna za armaturu
- Turska vrata kupelji na dugoj strani (osim koda 5010100 - kratka strana)
- Isključujući obloge (kamenno posuđe, pločice itd.) i cijevi za transport pare

Šifra	Opis	Dimenzije spoljne širina x dubina x visina [mm]	Volumen [m ³]	Generator [kW]	Cena
KABINE PRAVOUGAONE OSNOVE					
5010116	Standardna pravougaona kabin 150	1500 x 1200 x 2400	2,7	3,0 230 V/ ~1	7.355,00 €
5010117	Standardna pravougaona kabina 180	1800 x 1200 x 2400	3,3	4,5 400 V/ ~3	8.355,00 €
5010100	Ariete pravougaona kabina	1800 x 1600 x 2400	4,5	4,5 400 V/ ~3	10.635,00 €
5010118	Standardna 200 pravougaona kabina	2000 x 1500 x 2400	4,65	4,5 400 V/ ~3	10.995,00 €
5010102	Standardna 250 pravougaona kabina	2500 x 2000 x 2400	8,15	10,5 400 V/ ~3	€ 14.504,00
5010119	Standardna 300 pravougaona kabina	3000 x 2000 x 2400	10	10,5 400 V/ ~3	17.097,00 €
5010104	Standardna pravougaona kabina 300-1	3000 x 2500 x 2400	13	12 400 V/ ~3	20.798,00 €
5010106	Standardna pravougaona kabina 350	3500 x 3000 x 2400	18,75	15 400 V/ ~3	€29.401,00
KABINA KVADRATNE OSNOVE					
5010120	Standardna kabina od 150 m ²	1500 x 1500 x 2400	3,55	4,5 400 V/ ~3	7.755,00 €
5010101	Standardna kabina od 200 m ²	2000 x 2000 x 2400	6,55	7,5 400 V/ ~3	11.864,00 €
5010103	Standardna kabina od 250 m ²	2500 x 2500 x 2400	10,5	10,5 400 V/ ~3	€ 17.297,00
5010105	Standardna kabina od 300m ²	3000 x 3000 x 2400	15,85	12 400 V/ ~3	20.638,00 €

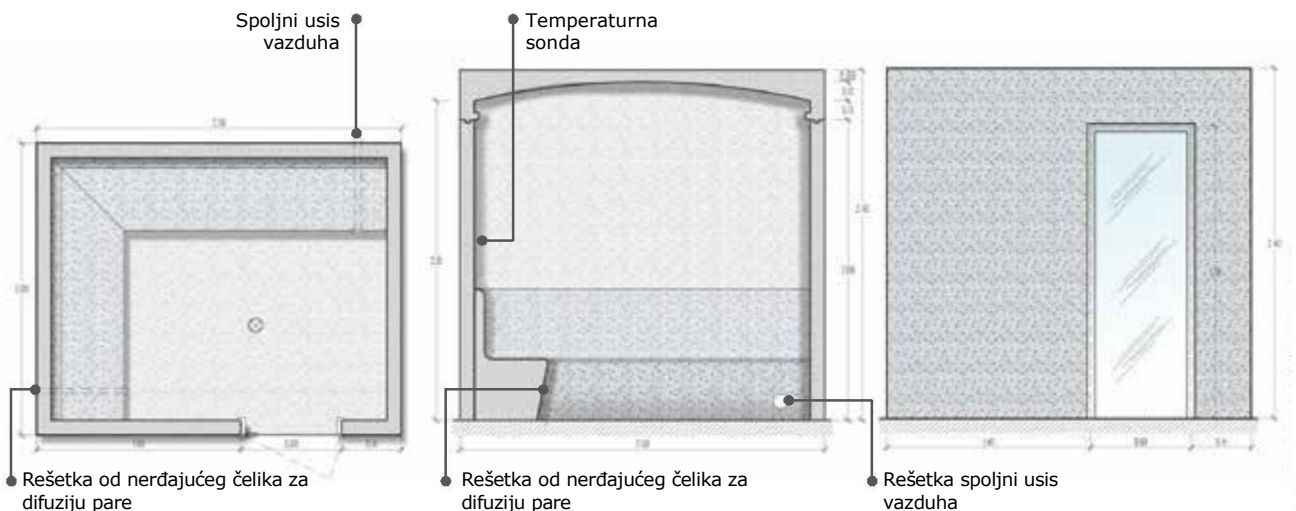

KABINA DIAMANTE / DIAMOND CABIN



KOMPLET STRUKTURA U PANELIMA EPS

- Generator toplote, napon trofazni, konekcija para od Ø 30 mm
- Sonda temperature
- Komplet fittinga za spajanje uređaja, masa za gletovanje, latex, armirna vlakna
- Vrata za tursko kupatilo INOX

Kit panel structure in EPS

- Steam generator, three-phase power, steam connection Ø 30 mm
- Remoting kit for terminal humidifiers
- Fittings for connection kit installation, skim coat, latex and fiber reinforcement
- Gateway to turkish bath in stainless

Šifra /code	Opis /description	Dimenzije(spoljne) / Dimensions širina x dub x visina width x depth x height [mm]	Zapremina Volume [m3]	Generator Generator [kW]	Cena/price
5010108	Cabina Diamante oktagonalna/ Diamond octagonal cabin	2400 x 2400 x 2400	7,5	7,5 400 V/ ~3	13.064,00 €

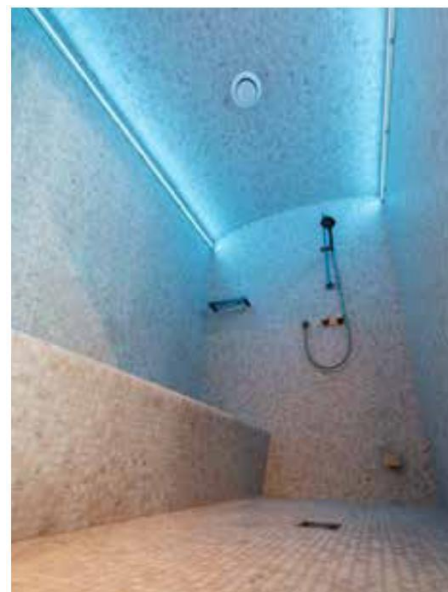
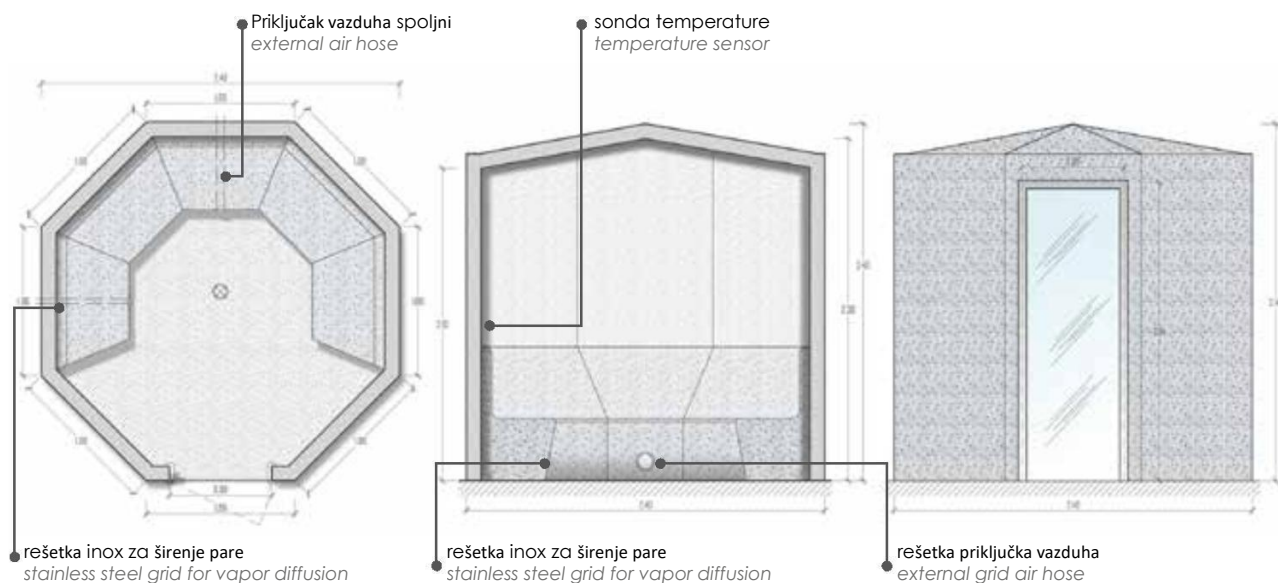

PODVODNI ZVUČNIK



Ugradni zvučnik izrađen od poliesterske smole ojačane stakloplastikom i poliuretanom (materijal neosjetljiv na hlorisanu vodu), vodonepropusan i otporan na udarce. Kablo od 3 m homologovano za prenos električne energije i potpuno potopljeno. Jedan zvučnik dovoljan je za bazen od 35 m³.

- Snaga: 60 vata/8 Ω . Propusnost: 40 Hz do 16000 Hz.

Šifra	Opis	Cena
5010014	Ugrađeni zvučnik s kablom 3 m	2.012,00 €

ZVUČNIK ZA VLAŽNE AMBIJENTE



- Otporan na slanu vodu
- Maksimalna snaga 20 vata - 4 Ω
- Za stereo kvalitetu osigurajte 2 zvučnika
- Nema niše

Šifra	Opis	Cena
5020359	Crni zvučnik sa zaštitom Ø90 mm	119,30 €



GENERATORI SUPERSTEAM



Steamcontrol

Parni generatori za hamam i tursko kupatilo. Supersteam je izrađen od nerđajućeg čelika, može se ugraditi do 15 m od kabine. Ima LED indikatore za samodijagnozu i preciznu temperaturnu sondu.

Supersteam generatori rade s zamjenjivim otpornicima, preporučuje se osigurati vodu niske tvrdoće kako bi se izbjeglo stvaranje kamenca i začepljenja.

Supersteam komplet uključuje:

- Kotao sa otporom (bez cevi za transport pare)
- Steamcontrol display za montažu uza zid, sjajna kromirana završna obrada
- Sonda sobne temperature

Šifre	Opis/opis	Napon	Snaga/kapacitet kW	Volumen kabine/ m ³	Cena
5020480	Supersteam generator 150E	400V /tri	6	2.8~ 3.03	5.432,90 €
5020481	Supersteam generator 400E	400V /tri	9	4,57 ~ 7,28	6.248,90 €
5020482	Generator Supersteam SUPER2E	400V /tri	12	9,61 ~ 11,64	7.666,10 €
5020483	Generator Supersteam SUPER3E	400V /tri	15	11,65 ~ 13,65	8.568,00 €
5020493	Supersteam MX4E / Supersteam Generator	400V /tri	20	13,66 ~ 19,2	10.092,00 €
5020494	Supersteam MX6E / Supersteam Generator	400V /tri	30	23,29 ~ 27,3	11.230,80 €

PARNI DIFUZOR



Parni difuzor SteamLine ima vodoravni profil s čistim i uskim otvorom difuzora za emitiranje tanke trake pare stvarajući "obrnutu kaskadu".

Glavne karakteristike:

- Izrađena od anodiziranog aluminijuma
- Savršeno integriran u zid
- Otvor širine 36,83 cm



Šifre	Opis	Cena
5020486	difuzor SteamLine	1.000,70 €

AUTOCLEAN SISTEM AUTOMATSKOG ČIŠĆENJA

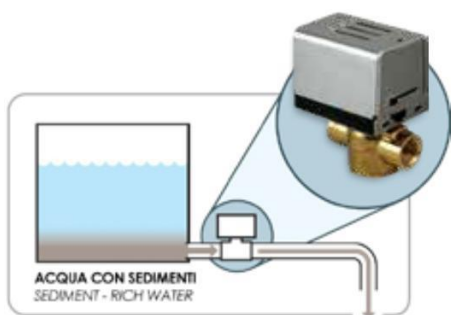

Automatski sistem samočišćenja za poboljšanje performansi i trajnosti generatora pare:

- Unosi svežu vodu pre svakog parnog ciklusa i drenira rezervoar nakon upotrebe
- Pomaže eliminisati depozite
- Autoclean osigurava čistu paru svaki put.

Kod	Opis	Cena
5020487	* Sistem automatskog čišćenja	906,20 €
	* Za Supersteam generatore	

GENERATORI MISTER STEAM



Mlaznica difuzora pare



Upravljačka ploča

Generatori pare za hamame i turska kupatila pogodni za kućnu upotrebu. Komplet generatora Mister Steam uključuje:

- Kotao sa otporom
- Ugrađeni display osjetljiv na dodir
- Sonda za sobnu temperaturu
- Difuzor pare

Mogućnost upravljanja rasvetom. Jedinica display prekidača može se odvojiti od ovlaživača zraka i daljinski povezati. Mister Steam generatori pare rade s zamenjivim otpornicima, ali preporučujemo da osigurate vodu niske tvrdoće kako biste izbegli stvaranje kamenca i začepjenja. Jednostavnost korištenja zahvaljujući grafičkom prikazu.

Šifra	Opis	Napon	snaga kW	Volumen kabine m ³ /	Cena
5020344	Komplet generatora pare JEDNOFAZNI / JEDNOFAZNI generator	230 V/mono	3	2~4	911,00 €
5020345	Komplet generatora pare JEDNOFAZNI / JEDNOFAZNI generator	230 V/mono	4	3~5	933,70 €
5020308	Komplet generatora pare TROFAZNI / TROFAZNI generator	380V /tri	4,5	3~5	911,00 €
5020304	Komplet generatora pare TROFAZNI / TROFAZNI generator	380 V /tri	7.5	6 ~ 8,5	919,70 €
Modeli s unutarnjim pomoćnim upravljanjem ON / OFF					
5020346	Komplet generatora pare TROFAZNI / TROFAZNI generator	380 V/tri	7,5	6 ~ 8,5	1.060,00 €
5020347	Komplet generatora pare TROFAZNI / TROFAZNI generator	380 V/tri	10.5	8 ~ 11	1.293,00 €
5020348	Komplet generatora pare TROFAZNI / TROFAZNI generator	380 V/tri	12	11~14	1.354,00 €
Rezervni deo					
603-00010	Kontrolna tabla generator KS-320 / Generator upravljačke ploče KS-320				180,00 €
603-00028	Mlaznica difuzora pare 1/2" / mlaznica difuzora pare 1/2"				75,70 €
603-00029	Mlaznica difuzora pare 3/4" / mlaznica difuzora pare 3/4"				75,70 €

PROFESIONALNI GENERATORI PARE



Generatori pare s velikim grafičkim display koji vam omogućuje upravljanje centralizirano:

- dnevna i nedeljna razdoblja rada;
- različite tačke podešavanja temperature za vremenske intervale;
- do 3 aktuatora za raspodelu esencija i 1 za sanitarni ciklus;
- do 2 ventilatora i unutrašnje svjetlo kabine;

Cene i modeli na upit

OPREMA ZA TURSKO KUPATILO



Šifra 5020468



Šifra 5020467

Šifre	Opis	Cena
5020411	Čelično spiralno crevo za provod pare Ø30 mm /	52,30 €
5020462	Prekidač za hitne slučajeve s pozadinskim osvjetljenjem (suvi kontakt)	395,40 €
5020463	Prekidač za uključivanje/isključivanje s pozadinskim osvjetljenjem (dostupne boje: plava/ zelena/crvena)	423,60 €
5020467	Ručni tuš s dugmetom za podešavanje izlaz za vodu/	311,70 eur
5020468	Klasična Nova vrata – ram 790x1890 mm	€1,670,00

Nezamenjiv element za ispravan ciklus relax-tretmana , tuš se namešta na izlazu iz turskog kupatila i saune, dajući veliku telesnu blagodat zahvaljujući razmeni temperatura.

PERLA



Struktura kabine u polistirenu, zidne ploče s nedovršenim plafonom na unutrašnjem delu, zaptivni ketridž, mrežasta traka i hidroizolacijski paket. Unutrašnje dimenzije: 90 x h 230 cm / Spoljne dimenzije: 200 x 155 x h 240 cm Bez obloge i poda.

Šifra	Opis	Cena
5010020	Perla tuš kabina / Perla tuš kutija	5.708,00 €

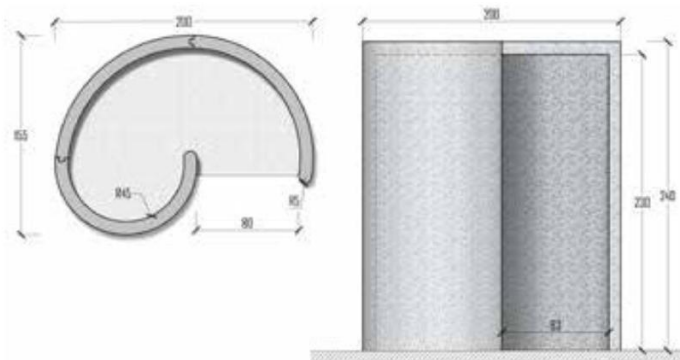

Tuš kabina Perla

RUBIN

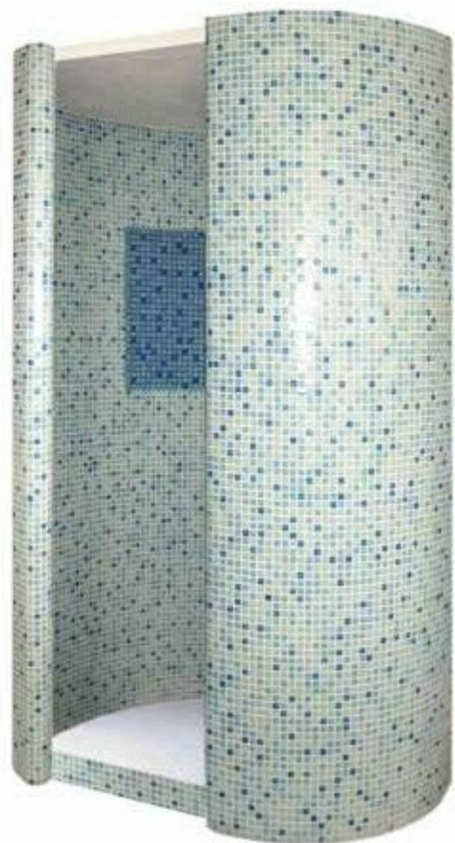

Struktura kabine u polistirenu, sa zidnim panelima i nedovršenim plafonom. Rubino 140: unutrašnje dimenzije: 120 x h 230 cm / spoljne dimenzije: 140 x h 240 cm Rubino 160: unutrašnje dimenzije: 140 x h 230 cm / spoljne dimenzije: 160 x h 240 cm Bez obloge i poda.

Šifra	Opis	Cena
5010021	Tuš kabina Rubino 140	4.659,00 €
5010022	Tuš kabina Rubino 160	5.408,00 €

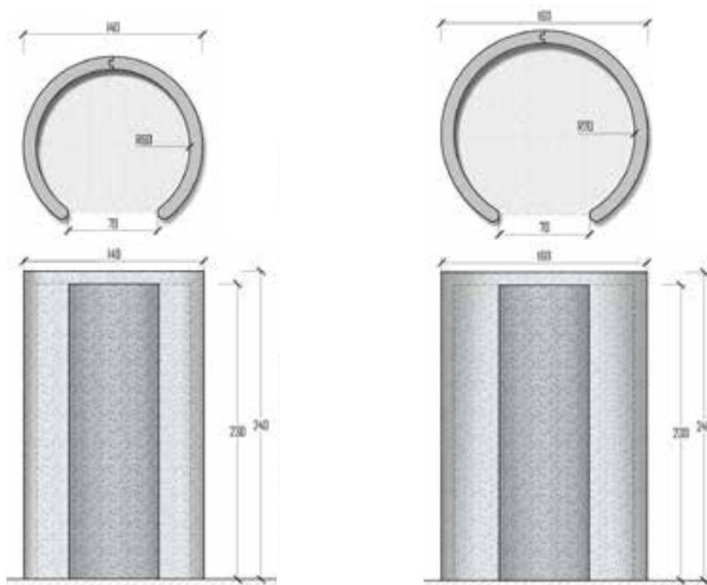

Rubin 140

Rubin 160

TROPIKALNE KAPI I HLADNI POVETARAC / TROPICAL DROPS AND COLD BREEZES

Duvalica tropska kiša ugradna od hromiranog čelika finiš ogledalo, dimenzija 420x420 mm. Hromoterapija instalirana na samoj duvalici, kompletna sa : 4 reflektorčića led RGB, napajač, kontrola i daljinski, električne konekcije.

Model 5010078 uključuje tehnologiju hladna magla montirana na samoj duvalici.

Tastatura komandna od hromiranog čelika sa 1 prekidačem (za model 5010077) ili 2 prekidača (za model 5010078).

Opcija aromaterapija instaliran na duvalici kompletnoj sa : aroma pumpa con sa podesivim protokom, propuh sa alarmom nestanka esencije, 5 Litara esencije, reléj i električni spojevi.

Built-in tropical rain shower shower head in mirror-finish chrome steel, dimensions 420x420 mm. Chromotherapy is installed on the same showerhead, complete with : 4 RGB LED lights, power supply, control and remote control, electrical connections. Model 5010078 includes cold fog technology mounted on the same showerhead. Chrome-plated steel control keyboard 1-button (for the model 5010077) or 2-buttons (for the model 5010078). Aromatherapy option installed on the central shower head complete with : aroma pump with adjustable flow, draft with end-of-essence alarm, 5 litres of essence, relays and electrical connections.

Šifra /code	Opis /description	Cena/price
5010077	Emocionalni tuš kiša I hromoterapija / Emotional rain shower and chromotherapy	6.973,00 €
5010078	Emocionalni tuš kiša , hromoterapija I magla/ Emotional shower rain, chromotherapy and mist	7.647,00 €
5050625	Opcija hromoterapija / Chromotherapy option	742,00 €

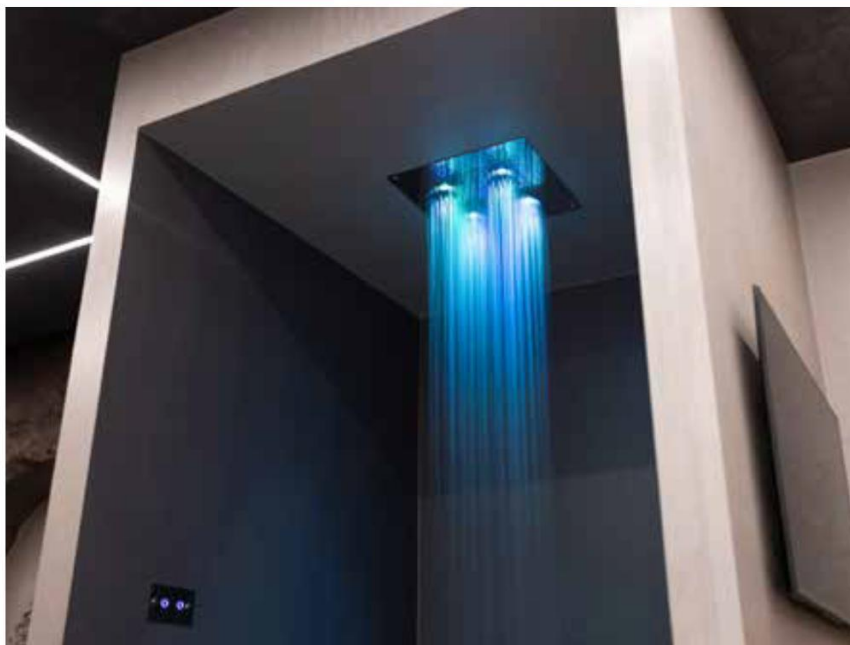

TUŠEVI

MERCURY glava tuša: U hromiranom mesingu, završna obrada sa nitnama, 1/2" priključak zajedno sa spojem.
TONDO glava za tuširanje: Bočna glava tuša u hromiranom mesingu s mlaznicama protiv kamenca u kompletu s niplesima od 1/2" i baldahinom. ECLIPSE glava tuša: U hromiranom ABS-u protiv kamenca, 1/2" priključak zajedno sa pregibom.



Šifra.5010045



Šifra.5010046

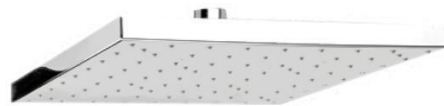

Šifra.5010047

Šifra	Opis	Cena
5010045	Hromirana mesingana glava tuša NEW MERCURY Dimenzije: Ø300 mm	743,40 €
5010046	Bočna glava tuša u hromiranom mesingu TONDO Dimenzije: Ø32 mm	69,50 €
5010047	ECLIPSE hromirana ABS glava tuša Dimenzije: 250x250 mm	392,40 €



A

Acqua bubble	hidromasažni četvrtasti	358
Acqua bubble	hidromasažni okrugli	358
Acquamarina pool		464
Algicidi		440
Alkorplan 1000 membrana od armiranog PVC jednobojna		72
Alkorplan Bio Bazeni		77
Alkorplan TOUCH Membrana od armiranog PVC reljefna		75
Alkorplan Hidraulična linija		78
Alkorplan 1000 Membrana PVC armirani jednobojna		72
Alkorplan touch membrana od armiranog PVC štampana		75
Alarm precizni		339
Anode magnezijumske UNIKO Mg		285
Aparati za velike vodene parkove		413
Aqua Broom-hidraulični čitač		422
Aqualiner 75/100 I lajner od PVC jednobojni ili štampani		68
Arco mašinski prostor		236
Arena industrijski pločasti filter		298
Aromaterapije i esencije		515
Atlantic mašinska prostorija		246
Autochlor RP		281
Autochlor RP-ph		281
Antifriz plovci		399
Asortiman Elbtal		79
Asoriman Renolit		71
Asortiman Akrilne stepenice		58
Aluminjumska kuka za spasavanje		430
Antivibrirajući spojevi Danfos Socla sa prirubnicom galvaniziranog čelika		214
Aktivni kiseonik I brom		441
Automatski čistači MOZZO		424
Automatski čistači -MAGNUM		426
Antivibrirajući spojevi sa prirubnicom galvaniziranog čelika		210
Abs zakrivljena rešetka		52
Aparat za varenje lajneraLeister		88
ABS podni slivnici za lajner		116
Antivortex obojeni slivnik		128
AM Peći za saune		517

B

Belbo mašinska prostorija	242
Baterije povratne sa ručnim i automatskim rukovanjem	307
BOX postolje 65/75	248
Blokovi startni	321
Bodujet Smart protivstrujno plivanje	187
Biancopuro™	285
Big Mac mašinski prostor	235
Bodujet wave protivstrujno plivanje	187
Blu HBS SA RUKAMA filter	301
Blue Star Family 100-125	460
Blue Star Luxe 125-140	461
Boa za spasavanje	321
Bellow Jet Set protivstrujnog plivanja	189
Brizgaljka sa tečnim ABS za popravke	146
Bazeni Rondo-lajner rezervni	455
Bazen Espace ravna ivica	93
Bazen Espace tradicionalna ivica	93
Bazen Roddi ivica	
Bazen Rosalind ivica	91
Bazen Spa Yui	478
Blok od stiropora ISOBLOK	26
Beton usisivač	429
Bazen White pool samostojeći, čelični	463
Bordura ESPACE	93
Beth sigurnosna ograda	339
Blatna usisna mlaznica	155

C

Cat-fish hidraulični čistač	423
Classic B1.1. Prekrivka sa šipkom	393
Comodo mašinska prostorija	241
Contura-roletna prekrivka	383
Contura električna roletna prekrivka	383
Contura solare roletna prekrivka	383
Čišćenje filtera i cevi	443
Čišćenje poda i zidova	443
Čepovi za odmrzavanje	
Cevi za pneumatske komande i Piezo električne komande	197
Cevi PVC	211
Četke za zid	431
Čistači hidraulični	422
Cev rebrasta sa spojkom	432

ABECEDNI SADRŽAJ

E

E.Swim a varijabilne brzine DAB	181
Easy Pool hlor slobodni-pH	411
Ecorete Eltex – zimska prekrivka	399
Elbtal Pearl 160/100 - membrana od PVC armiranog Štampana	84
Elbtal 150/100 - membrana od PVC armirana jednobojna	80
Elbtal Elite - membrana za oblaganje ojačana	81
Elbtal Island Dreams – membrana za oblaganje ojačana	83
Elbtal Pure Pool Passion	82
Elbtal WBT – membrana za oblaganje za jezerca	84
Elektroliza soli	279
Energy Control sa pneumatskim transduktorom	226

Eps Blok 1000 modulo pravi	31
Eps Blok zakrivljeni 90°	32
Eps Blok moduli unapred zakrivljeni	32
Ercolano fungo za javni bazen	354
Esencije	502
Električno termički grejači od titanijuma serije D-EWT-TI	271
Ekspanzioni ekseri	88

F

Filter sa umetkom	169
Filter mas	296
Filteri Monoblok Argento, Havana, Mexico i Alba	467-468
Filter serije Atlantico standardi UNI	306
Filter serije Europa namotan	305
Flagon membrana za oblaganje za jezerca	70
Fiting za Eco Spark	276
Fiting u Pvc T	202
Fiting u PVC REDUKTORI	198
Flokulanti	441
Fiting u PVC priključak za rezervoare zidni prodor vdl	205
Fotometar digitalni	434
Frize Touch-obloge	76
Fiting u PVC pod pritiskom	207

ABECEDNI SADRŽAJ

Kabina sauna na infracrvene zrake LUNA i GLORIA	510
Kolica za namotavanje traka i opreme	320
Komplet stuba kontrole nivoa kompenzacionog rezervoara fi 63	55
Kontrolni set na daljinu linija Weltico	1 54
kočioni set Pushlock	3 68
Kada tuša Lake	336
Konzervacija i vremensko trajanje membrane	4 19
Komandne table Pool Control	2 25
Komadna tabla hidromasaže sa piezoelektričnim prekidačem	2 27
Kružne stepenice	6 4
Komandna radio kutija	1 43
Kutija nosača greda	369
Kantice	515
Kiwi - Peč pza saunu	518
Kiwi mašinska prostorija	238
Kompenzacioni rezervoar i oprema	55
Kadice za pranje nogu	337
Kontejneri za smeštaj i ulošci za smeštaj	413
Kolica univerzalna za prenos pumpi	178
Lamele za prekrivku	389
Letnja prekrivka sa mehurićima	401
Letnja prekrivka sa mehurićima ulica laka	401
Letnja prekrivka mousse	401
Lampa led za univerzalni serije MT-4reflektor	139
Lampa UVC zraci	287
Lampa koja se dopunjava ,nepromočna i mobilna	144
Lampa UV srednje niskog pritiska	289
Lampe UV zraci	288
Lampe univerzalne za brzu montažu	154
Lampica Greta-fiksna boja	159
Lepila i zaptivne mase za fitting	215
Lamele za prekrivku	389
Lampa led za reflektor univerzalni serije MT-4	141
Lampa UVC zraci	287
Lampa koja se dopunjava ,nepromočna i mobilna	144
Lampa UV srednje-niskog pritiska	289
Lampe UV zraci	288
Lampe univerzalnebrze montaže	154
Lampica led Greta -fiksna boja	159
Leister APARAT ZA ZAVARIVANJE	89
Ležaljka od čelika inox	357
Ležaljka od čelika inox Zeus	356
Liberty Spa	42
Linea Lo-Chlor	446
Linerlock završni profil	85
Lepak,teflon i rastvarači	216
Lube Magic podmazivač	215
Lajner usisivač	4 23
Lišća sakupljač	430

M

Mac 6 mašinska prostorija	2 34
Motalica za prekrivke Arione i Reel	403
Manometri, slavine za uzorkovanje i termometri	317
Master mašinski prostor	245
Mrežice	429
Max 200 – automatski čistač	425
Max 300 – automatski čistač	425
Max 400 – automatski čistač	425
Mediterraneo Side - filter	162
Mediterraneo Top - filter	1 63
Merlino	2 18
Motalica za prekrivke Omega	402
Mini reflektor led Lory Pool za bazen, fiksna boja i RGB	157
Mini reflektor led Luke za bazen, fiksna boja i RGB	158
Mini reflektor serije MT-4 za šrafljenje na mlaznicu	139
Mini reflektor serije MT-3 za bazene od betona i liner	149
Mini reflektor serie MT-3 za bazene od panela i fiberglasa	150
Merači protoka paletno digitalni	317
Moderna - peć za saunu	517
Moduli za kolektore od PVC in PN10	207
Monoblok Argento	467
Monoblok Havana	468
Monoblok Mexico	468
MOOVE ¹ O Solare – prekrivke roletne	387
Motalica za prekrivku Vela	402
Mlaznica jednostruka	330
Model samostojeći NIAGARA	594
Mlaznica Usisna serije MT-14	451
Mt-3 podni slivnici	421
Mlaznice čelične inox Aisi 316	1 49
Mlaznice potisne	1 32
Mlaznice podne serije MT-14	1 52
Mlaznice podne serije MT-3	1 41
Mlaznice potisne serije MT-14	1 52
Mlaznice potisne serije MT-3	1 42
Mlaznice potisne i usisne	132
Mlaznice sa prolazom	1 17
Merači protoka Pitot	3 17
Master rešetka zakrivljena	51
MT-14 podni slivnici	1 46
Mlaznica usisna serije MT.3	1 41
Mlaznice GM-12	117
Mlaznice GM-15	119
Mlaznice GM-18	120
Mlaznice hidromasažne	1 85
Mlaznice potisne podne	1 50
Multifunkcionalni dizinfektant	4 44
Mašinska prostorija GLOBO	2 44
Mašinska prostorija HELIO	2 43
Mašinska prostorija Kiwi	238

M

M

Panama Side SP - filter	164
Panama Top - filter	164
Paneli montirani: mod WPHRH	410
Paneli solarni Eco-Spark	270
Zidni prodor serije MT-3	118
Zidni prodori in ABS	131
Spoljni podovi i ivice bazena	88
Poklopac za prekrivanje otvora za potopljene prekrivke	369
Pločice i ivica Castellane	92
Pločice i ivica Espace	90
Protivkrečnjak	416
Priključci i fitinzi za mašinske prostorije	244
Postolje za monoblok Nettuno	245
Prelivna ivica Finlandese	49
Ploča za okret	315
Ugaone ploče za rešetke	52
Ugaona ploča za rešetke FS47 e FS90	52
Polaris Side filter sa rukom sa visokim filtrirajućem slojem	300
Pumpa Badu Eco Flex varijabilne brzine	173
Pumpa Badu Eco Touch Pro varijabilne brzine	172
Pumpa za doziranje kiseline regulisanje tečnog hlora Redox	404
Pumpa za doziranje kiseline regulisanje pH	404
Pumpa doziranje protivgijivično i flokulant	406
Pumpa za doziranje esencije	406
Pumpa za doziranje esencije pri niskom pritisku	406
Pumpa za doziranje kiseonika	405
Pumpa elektromagnetica pH	405
Pumpa elettromagnetna Redox	405
Toplotne pumpe Bluefire Junior	252
Toplotne pumpe Bluefire Senior e Master	253
Toplotne pumpe Indiana Evo-mini	254
Toplotne pumpe Indiana Evo-E-M-P-V-INDUSTRIAL	255
Pumpe hidromasažne za Spa - serie WP 300-II	172
Pumpe serie Aurora sa i bez predfiltera	306
Pumpe serije Ghisa NM	309
Pumpe serije Ghisa NM4	310
Pumpe serie River	308
Potopljene pumpe za prekrivke	397
Pozicioniranje zidnih elemenata	111
Prelivna ivica Spiaggia	50
Prelivna Ivica Standard	49
Prelivna ivicaTwenty niska	3 6
Prekrivke nadzemne i lajner	4 63
Prekrivke za Blue Star	460
Prekriven ram bojen,savršena harmonija sa poklopcem	130
Plutajuće trake	316
Prefilteri odmašćivači od čelika inox	312
Prefilteri odmašćivači polipropilenski i polifenilenoksidni	311
Premium B-2.1 – Prekrivka sa šipkom	392
Prirubnice,zaptivke,prstenovi,vijci,šajbne,nosači	195
Prirubnica,rešetka,zaptivka,savršena harmonija,mlaznica C-319	134
Pravougaoni Niagara i Linea drveni bazeni	457
Podni slivnici	1 38

ABECEDNI SADRŽAJ

Plutajući raspršivači hlora	430
Peskirana rešetka	5 1
Priscille — tobogan od fiberglasa	336
Pro - peć za saunu	516
Pro 1500 — hidraulički čistač	421
Proizvodi dodatni za prekrivke	89
Proizvodi za zaštitu i staranje o pločicama i ivicama	94
Proizvodi za tretman Spa	499
Proizvodi opreme za Spa	513
Proizvodi za Alkorplan	76
Proizvodi za liner	84
Specijalni proizvodi i tretmani podrške	440
Projekti SPA centri	500
Peskirana ivica bazena	84
Polipropilenska zakrivljena rešetka	50
Parni difuzor Seam line	521
Podesiva višestruka mlaznica	330
Prekrivka zimska	394
Prekrivka zimska PVC	395
Plažni tuševi	334
Plutajuće cevi 38 mm pool flex	407
Peć za saunu KIWI	516
Podmazivač Magic Lube	209
Prostirka pur pena Monviso sa lepljivom trakom	241
Protect liner	8 5
Protiv prolivanja deo Messicani	8 5
Protivstrujno plivanje Angel River i Gulfstream od čelika inox	180
Protivstrujno plivanje Kit Niagara	182
Prigušivač preлива	140
Pool New superior slobodni hlor-ph-flokulant	409
Prekidači inox	
PVC tečni Alkorplan Xtreme	73
PVC tečni za Alkorplan	73
PVC tečni za Elbtal	8 1
Podizač pacijenata električni	299
Podizač pacijenata hidraulični	299
Oprema za mlaznice	132
Oprema prekrivki	396
Oprema instalacija, mini reflektor i ravni reflektor-serije MT.4	135
Oprema instalacija za reflektor micro-serije MT-4	136
Oprema prekrivke Onda new i Niagara	456
Oprema za tursko kupatilo	520
Oprema aluminijumski kompresori, usisni ventili, prigušivači	183
Oprema za solarne tuševe	335
Onda New	454
Onda New modeli samostojeći	453
Opcije za prekrivke B-1.1 i B-2.1	393
Obloga extreme	74
Oznaka traka	64
Odmrzivač	417



R

Oprema nadzemna	466
Oprema za lajnere	427
	200
Oprema za hidromasažne klupe	162
Oprema za pumpe	428
Oprema za skimer	145
Oprema za skimer serije MT-14	4 30
Oprema čišćenja bazena	4 32
Oprema čišćenja serije CPA	431
Oprema čišćenja serije premium	466
Oprema razno nadzemnih	457
Oprema Weva	135
Oprema skimer	344
Rambouillet u sastavu da 2 dela za bazene sa prekrivkama	502
Rezervni uložak za SPA	135
Regulator nivoa	151
Regulator nivoa, mlaznica nivoa MT-14	436
Regulator pH	158
Rezervni uložak za filtere	192
Rezervni delovi i oprema hidromasažnih mlaznica	60
Rezervni delovi za stepenice	325
Rio grande – Plovljiva mirna reka	150
Razvodna kutija	138
Razvodne univerzalne kutije	318
Rešetke za ivice i obloge	161
Rivalta Side - filter	161
Rivalta Top - filter	348
Rukohvat Inox	426
Robot Magnum e Magnum Junior	424
Robot Mozzo Advance Top	424
Robot Mozzo Advance Top Super 3000	426
Robot Ultramax e Ultramax Junior	236
Roc mašinska prostorija Arco	377
Rolleasy 2 – roletna prekrivka	379
Rolleasy 2 električna – roletna prekrivka	380
Rolleasy 2 manuale – roletna prekrivka	379
Rolleasy 2 solarna – roletna prekrivka	364
Rollenergy Evolution – roletna prekrivka	367
Rollin – roletna prekrivka	372
Rollinside – roletna prekrivka	384
Rollover – roletna prekrivka	385
Rollover električna – roletna prekrivka	386
Rollover solarna – roletna prekrivka	427
Ručke teleskopske	228
Regulacija nivoa tabla	8 1
Rastvarač i lepak	

Samostojeći bazen mediterraneo	4 6
Sone vreće za elektrolizu	1 70
Sone vreće za elektrolizu	2 82
Safety Cover 4 godišnja doba	3 91
Sauna na infracrvene Luna	5 10
Sauna na infracrvene Giada	5 11
Saunana na infracrvene Gloria	5 10
Sauna	5 07
Sauna baštenska	513
Sauna Giulia	508
Sauna Regina	509
Saune na infracrvene	508
Saune fínländesi	508
Saune profesionalne	512
Stepenice lakog pristupa	344
Stepenice ugaone	63
Stepenice ugaone sa klupom	62
Stepenice Balneo	60
Stepenice kružne	64
Scala Classica	346
Stepenice duple od smole podesive za nadzemne bazene	344
Stepenice od smole podesive za ukopane bazene	344
Scala Opera	59
Stepenice most-dupla za nadzemne bazene	341
Stepenice Relax	64
Stepenice Romana	58
Stepenice Sky	345
Stepenice Sofa	57
Stepenice sa sediljem sa hidromasažnim kompletom	62
Stepenice ispod lajnera	61
Stepenice Chambord	339
Stepenice Orleans	3 17
Stepenice model Finlandese za prelivne ivice	3 40
Stepenice Remy	340
Stepenice Trianon 304 e 316	339
Stiropor blokovi ISO BLOK serije KS	28
Set za čišćenje	428
Set za filtraciju sa filterom Mediterraneo	99
Set za filtraciju sa filterom Rivalta	99
Set rešetaka	125
Set za hidromasažu Acqua Bubble	186
Set za hidromasažu za structure u gradnji	193
Set za hidromasažu premontirani ,akrilnih stepenica Romana	194
Set paneli Twenty-Bazen Creta	37
Set paneli Twenty-bazen Jake	39
Set paneli Twenty-bazen Jamaica	3 8
Setz instalacije za električne prekidače	1 92
Set za kompletiranje opreme mlaz vodei fontane	352
Set bazena Acquaform	29

SADRŽAJ

Securypwall za ravno dno	3 45
Sedici mašinski prostor	2 09
Sedište fizioterapeutsko	3 31
stolica visoka za nadzor	2 97
Set bazena RONDO	4 50
Serendipity zemni ili plutajući	313
Serije Adria za protivstrujno plivanje i hidromasaža	164
Serije Arca	170
Serije Arca 2200-3000 za protivstrujno plivanje	172
Serie Breton 550-1500A za hidromasažu	163
Serie Carrera	156
Serie pumpe Ambra	160
Serie Speck Badu Energy	158
Serie Vienna	157
Set pumpi i duvaljki	3 56
Silicone tečni	59
Simply Pool pH i hlor	384
Simply Pool pH i kiseonik	384
Set henijskih proizvoda	442
Sistem protivkomaraca Mosquitos Bye	445
Sistem gradnje od čeličnih panela obostrano plastificiranih	35
Sistem automatskog čišćenja Autoclean	493
Sistem elektrolitični Premio+	252
Sistem elektrolitični Premio+ Duo sa dozir pumpom pH	252
Sistema elektrolitični Premio+ Duo Low Salt rad na niskom salinitetu	2 53
Sistem elektrolitični Premio+ Low Salt rad na niskom salinitetu	253
Skimfilter	136
Skimer Armonia Perfetta	126
Skimer in ABS per liner	116
Skimer inox	139
Skimer za panelne bazene	116
Skimer serije MT-14 od ABS za lajner	134
Skimer serije MT-3 u ABS za liner i za betonske bazene	130
Skimer prelivni LX7	115
Spojevi za stepenice	345
Set reflektora sa transformatorom	98
Set fittinga i cevi za podzemnu instalaciju -standard	100
Set fittinga i cevi samo za opremu MT-3	102
Set fittinga i ventila, mašinski prostor, pumpe i filter	105
Set Rondo Tonda	451
Spa Cristal	479
Spa Imperial	480
Spa Julia 250 ugradna	488
Spa Magnolia	477
Spa Major	481
Spa Mistral	485
Spa Orchidea	476
Spa Ortensia	479
Spa Liberty	4 1
Skakonica Ulisse	3 47

SADRŽAJ

Spa Duetto hidromasažna	487
Spa Regina	488
Spa Rokò	495
Spa Valentina	493
Set Rondo Ovale	453
Specifične tehnike asortiman Spaltalia	469
Speck Badu Energy Series	158
Stabilizator hlora	417
Set fitinga i ventila za javne bazene, seoski turizam/hoteli	104
Set Rondo Otto	450
Superior Pool hlor slobodni-pH	385
Big Happy five Tuševi	328
Tuševi Dada	332
Tuševi Energy pro	333
Tuševi funny Yang	334
Tuševi Happy five	335
Tuševi Happy Go	335
Tuševi Jolly E Big Jolly	335
Tuševi Jolly Go	335
Tuševi Spring	333
Tuševi tradicionalni Funny Yin	334
Tursko kupatilo HAMMAM	512
Tečnost protiv curenja	209
Taglioblok za rezanje i obradu Isoblok	28
Tanaro ploča sa difuzorima	274
Termičko električni grejači čelik inox serije D-EWT-EV	267
Termometri	407
Tipska šema hidromasažnog uređaja za zid	184
Tester digitalni Scuba	408
Tester i trousse in strips	408
Toplotni izmenjivači	260
Tirreno - filter	148
Termoelektrični dupli izmenjivači za SPA serijeEWX	266
Termički izmenjivač od čelika inox	263
Trasformatori	200
Protivklizni tretman	89
Termički izmenjivač od čelika inox XS	264
Trousse e ricambi dei test kit	409
Top lthaka inox 316	350
Termičko keramočki izmenjivač serije Evo	265
Tursko kupatilo	518
Termički izmenjivač od titanijuma serije D-KWT-TI	261
Tunel tuš sa fotočelijskim stubom	292
Twin filtere	136
Termički premontirani izmenjivač D-KWT-TI Compact	266
Tabletni hlor i granulat	440
TUŠ PANEL Gocce tropicali e Brezza Fredda	526
Tuš mlazevi spa hidromasaža	497

SADRŽAJ

Z

Zvučnik za vlažne ambijente	522
Zvučnik podvodni	522
Za postavljanje lajnera usisivač Q-vac	88

V

Ventil leptirasti	208
Ventili kuglasti	208
Ventil nepovratni	209
Ventili i manometri za filtere	168
Vreće peska diatomea	170
Vodeni top Corfu inox 316 bez ankerisanja	353
Vodopad Delfino	352
Vega Compact – peć ZA saunu	517
Verduno filter	300
Vodootporne i prozračne boje	65

V

Vodopad Mini los-inox 304 bez ankerisanja	350
Velikog protoka slivnici poda, za lajner po standardu UNI ENI 3451-3	316
Vodopad Ninfa	352
Vodopad Anaconda	353
Vodovod dekorativni Vesta inox 316	350
Vodopad Mezza luna inox -316-potrebno ankerisanje	350
Vazdušni eliminator vlage	278
Vodeni zidni mlaz Itaka-inox 316	352
Vođica kačenja za polaganje lajnera	86
Vodopadi	350
Voda grejanje	254
Vinner skakaonica 160	348